

TOSHIBA BiCD Integrated Circuit Silicon Monolithic

**TB67S102AFG, TB67S102AFTG, TB67S102AFNG****CLOCK-in controlled Bipolar Stepping Motor Driver**

The TB67S102A is a two-phase bipolar stepping motor driver using a PWM chopper. The clock in decoder is built in. Fabricated with the BiCD process, rating is 50 V/4.0 A .

**Features**

- BiCD process integrated monolithic IC.
- Capable of controlling 1 bipolar stepping motor.
- PWM controlled constant-current drive.
- Allows full, half, quarter step operation.
- Low on-resistance (High + Low side=0.49Ω(typ)) MOSFET output stage.
- High efficiency motor current control mechanism (Advanced Dynamic Mixed Decay)
- High voltage and current (For specification, please refer to absolute maximum ratings and operation ranges)
- Built-in error detection circuits (Thermal shutdown (TSD), over-current shutdown (ISD), and power-on reset (POR))
- Built-in VCC regulator for internal circuit use.
- Chopping frequency of a motor can be customized by external resistance and condenser.
- Multi package lineup
  - TB67S102AFG: HSOP28-P-0450-0.80
  - TB67S102AFTG: P-WQFN48-0707-0.50-003
  - TB67S102AFNG: HTSSOP48-P-300-0.50

Note) Please be careful about thermal conditions during use.

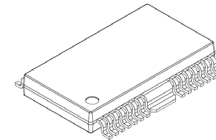
**FG**

HSOP28-P-0450-0.80

Weight 0.79g (Typ.)

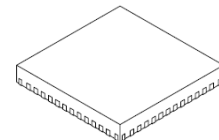
**FTG**

P-WQFN48-0707-0.50-003

Weight 0.10g(Typ.)

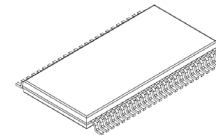
**FNG**

HTSSOP48-P-300-0.50

Weight 0.21g (Typ.)

**Pin assignment (TB67S102A)**

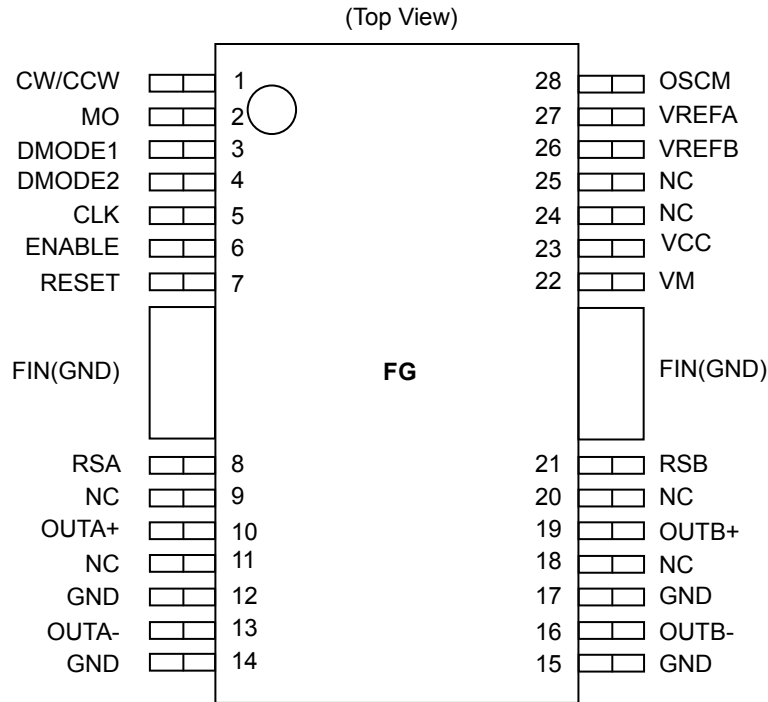

Please mount the FIN of the HSOP package to the GND area of the PCB.

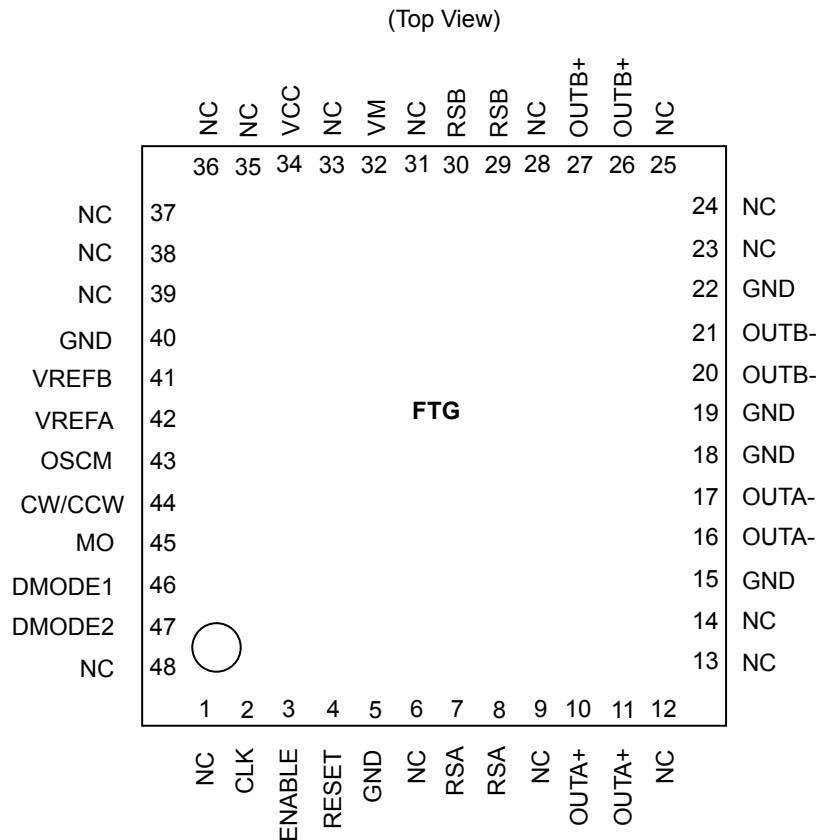

Please mount the four corner pins of the QFN package and the exposed pad to the GND area of the PCB.

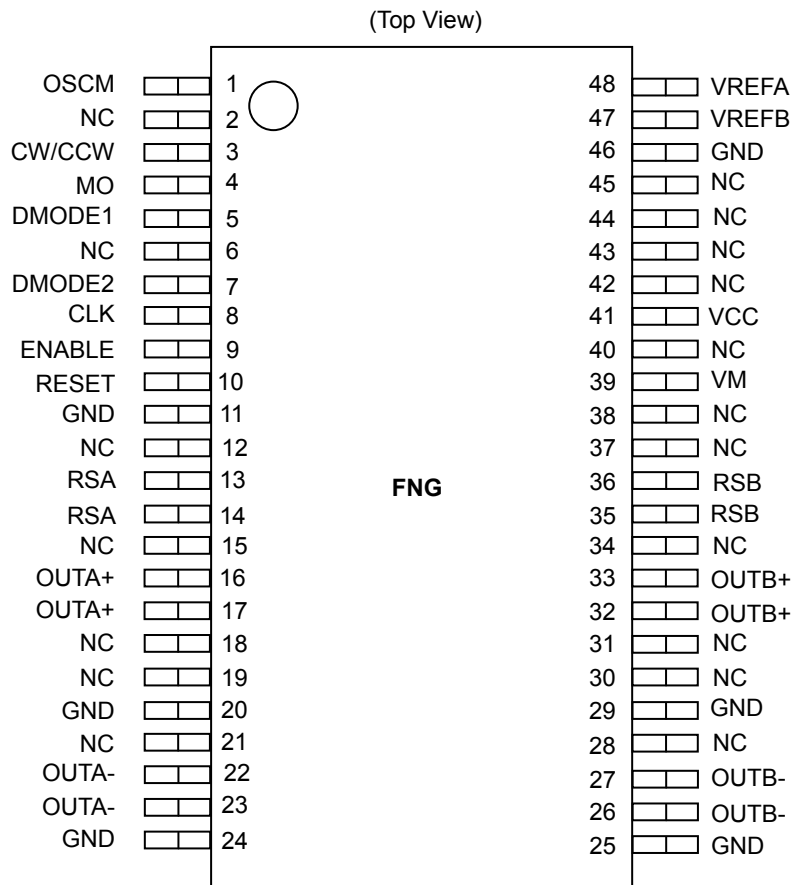

Please mount the exposed pad of the HTSSOP package to the GND area of the PCB.

**TB67S102A Block diagram**

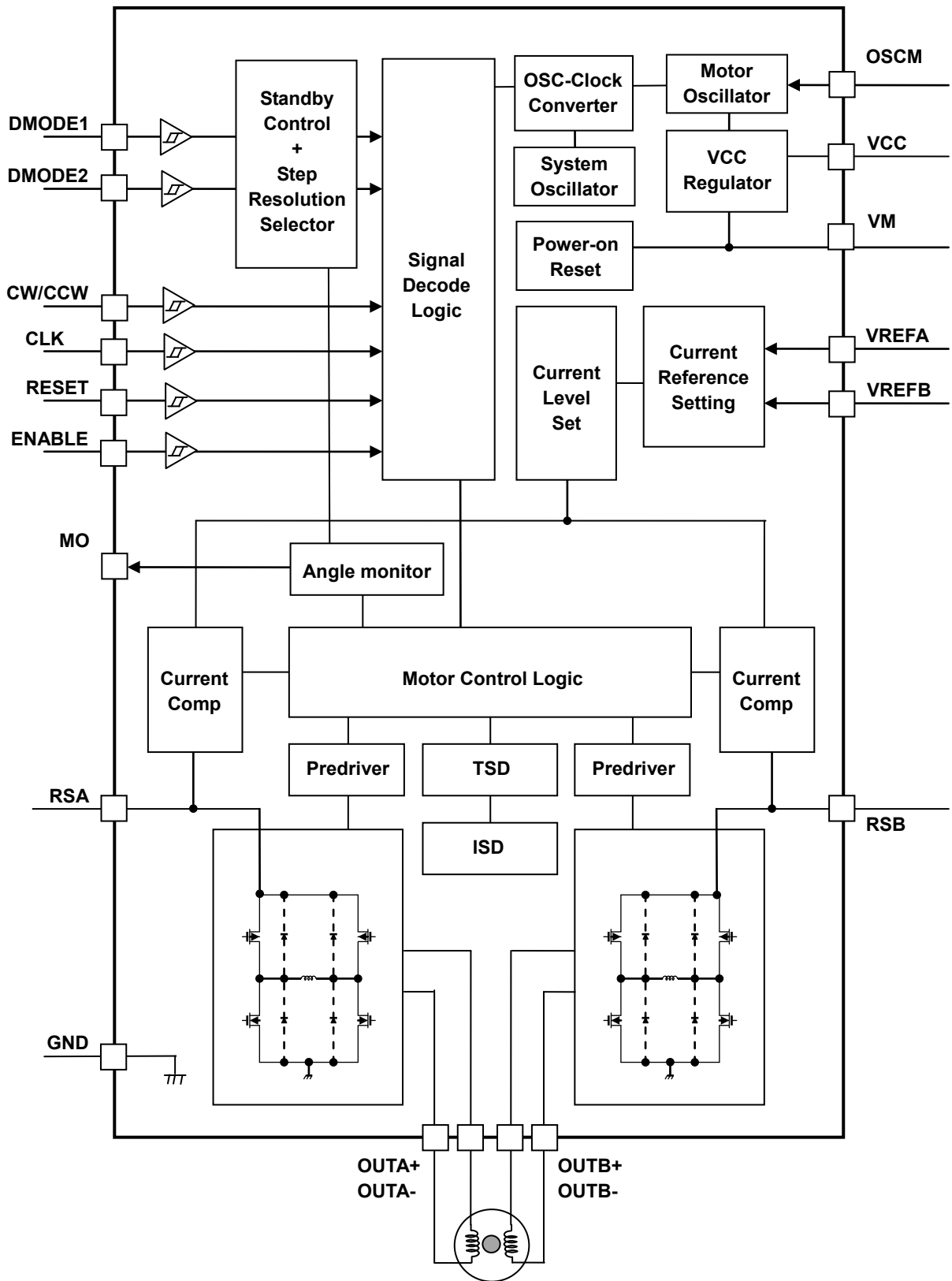

Functional blocks/circuits/constants in the block chart etc. may be omitted or simplified for explanatory purposes.

**Application Notes**

All the grounding wires of the TB67S102A must run on the solder mask on the PCB and be externally terminated at only one point. Also, a grounding method should be considered for efficient heat dissipation.

Careful attention should be paid to the layout of the output, VDD(VM) and GND traces, to avoid short circuits across output pins or to the power supply or ground. If such a short circuit occurs, the device may be permanently damaged.

Also, the utmost care should be taken for pattern designing and implementation of the device since it has power supply pins (VM, RS, OUT, GND) through which a particularly large current may run. If these pins are wired incorrectly, an operation error may occur or the device may be destroyed.

The logic input pins must also be wired correctly. Otherwise, the device may be damaged owing to a current running through the IC that is larger than the specified current.

## Pin explanations

### TB67S102AFG (HSOP28)

Pin No.1 – 28

Pin No.	Pin Name	Function
1	CW/CCW	Motor rotation direction set pin
2	MO	Electric angle monitor pin
3	DMODE1	Step resolution set pin no.1
4	DMODE2	Step resolution set pin no.2
5	CLK	CLK signal input pin
6	ENABLE	Ach/Bch output stage ON/OFF control pin
7	RESET	Electric angle reset pin
8	RSA	Motor Ach current sense pin
9	NC	Non-connection pin
10	OUTA+	Motor Ach (+) output pin
11	NC	Non-connection pin
12	GND	Ground pin
13	OUTA-	Motor Ach (-) output pin
14	GND	Ground pin
15	GND	Ground pin
16	OUTB-	Motor Bch (-) output pin
17	GND	Ground pin
18	NC	Non-connection pin
19	OUTB+	Motor Bch (+) output pin
20	NC	Non-connection pin
21	RSB	Motor Bch current sense pin
22	VM	Motor power supply pin
23	VCC	Internal VCC regulator monitor pin
24	NC	Non-connection pin
25	NC	Non-connection pin
26	VREFB	Motor Bch output set pin
27	VREFA	Motor Ach output set pin
28	OSCM	Oscillating circuit frequency for chopping set pin

Please do not run patterns under NC pins.

## Pin explanations

### TB67S102AFTG (QFN48)

Pin No.1 – 28

Pin No.	Pin Name	Function
1	NC	Non-connection pin
2	CLK	CLK signal input pin
3	ENABLE	Ach/Bch output stage ON/OFF control pin
4	RESET	Electric angle reset pin
5	GND	Ground pin
6	NC	Non-connection pin
7	RSA(*)	Motor Ach current sense pin
8	RSA(*)	Motor Ach current sense pin
9	NC	Non-connection pin
10	OUTA+(*)	Motor Ach (+) output pin
11	OUTA+(*)	Motor Ach (+) output pin
12	NC	Non-connection pin
13	NC	Non-connection pin
14	NC	Non-connection pin
15	GND	Ground pin
16	OUTA-(*)	Motor Ach (-) output pin
17	OUTA-(*)	Motor Ach (-) output pin
18	GND	Ground pin
19	GND	Ground pin
20	OUTB-(*)	Motor Bch (-) output pin
21	OUTB-(*)	Motor Bch (-) output pin
22	GND	Ground pin
23	NC	Non-connection pin
24	NC	Non-connection pin
25	NC	Non-connection pin
26	OUTB+(*)	Motor Bch (+) output pin
27	OUTB+(*)	Motor Bch (+) output pin
28	NC	Non-connection pin

Pin No.29 – 48

Pin No.	Pin Name	Function
29	RSB(*)	Motor Bch current sense pin
30	RSB(*)	Motor Bch current sense pin
31	NC	Non-connection pin
32	VM	Motor power supply pin
33	NC	Non-connection pin
34	VCC	Internal VCC regulator monitor pin
35	NC	Non-connection pin
36	NC	Non-connection pin
37	NC	Non-connection pin
38	NC	Non-connection pin
39	NC	Non-connection pin
40	GND	Ground pin
41	VREFB	Motor Bch output set pin
42	VREFA	Motor Ach output set pin
43	OSCM	Oscillating circuit frequency for chopping set pin
44	CW/CCW	Motor rotation direction set pin
45	MO	Electric angle monitor pin
46	DMODE1	Step resolution set pin no.1
47	DMODE2	Step resolution set pin no.2
48	NC	Non-connection pin

(\*) Note:

- Please do not run patterns under NC pins.
- Please connect the pins with the same pin name, while using the TB67S102A.



## Pin explanations TB67S102AFNG (HTSSOP48)

Pin No.1 – 28

Pin No.	Pin Name	Function
1	OSCM	Oscillating circuit frequency for chopping set pin
2	NC	Non-connection pin
3	CW/CCW	Motor rotation direction set pin
4	MO	Electric angle monitor pin
5	DMODE1	Step resolution set pin no.1
6	NC	Non-connection pin
7	DMODE2	Step resolution set pin no.2
8	CLK	CLK signal input pin
9	ENABLE	Ach/Bch output stage ON/OFF control pin
10	RESET	Electric angle reset pin
11	GND	Ground pin
12	NC	Non-connection pin
13	RSA(*)	Motor Ach current sense pin
14	RSA(*)	Motor Ach current sense pin
15	NC	Non-connection pin
16	OUTA+(*)	Motor Ach (+) output pin
17	OUTA+(*)	Motor Ach (+) output pin
18	NC	Non-connection pin
19	NC	Non-connection pin
20	GND	Ground pin
21	NC	Non-connection pin
22	OUTA-(*)	Motor Ach (-) output pin
23	OUTA-(*)	Motor Ach (-) output pin
24	GND	Ground pin
25	GND	Ground pin
26	OUTB-(*)	Motor Bch (-) output pin
27	OUTB-(*)	Motor Bch (-) output pin
28	NC	Non-connection pin

Pin No.29 – 48

Pin No.	Pin Name	Function
29	GND	Ground pin
30	NC	Non-connection pin
31	NC	Non-connection pin
32	OUTB+(*)	Motor Bch (+) output pin
33	OUTB+(*)	Motor Bch (+) output pin
34	NC	Non-connection pin
35	RSB(*)	Motor Bch current sense pin
36	RSB(*)	Motor Bch current sense pin
37	NC	Non-connection pin
38	NC	Non-connection pin
39	VM	Motor power supply pin
40	NC	Non-connection pin
41	VCC	Internal VCC regulator monitor pin
42	NC	Non-connection pin
43	NC	Non-connection pin
44	NC	Non-connection pin
45	NC	Non-connection pin
46	GND	Ground pin
47	VREFB	Motor Bch output set pin
48	VREFA	Motor Ach output set pin

(\*) Note:

- Please do not run patterns under NC pins.
- Please connect the pins with the same pin name, while using the TB67S102A.

## INPUT/OUTPUT equivalent circuit (TB67S102A)

Pin name	IN/OUT signal	Equivalent circuit
DMODE1 DMODE2 CLK ENABLE RESET CW/CCW	Digital Input (VIH/VIL)  VIH: 2.0V(min)~5.5V(max) VIL : 0V(min)~0.8V(max)	<p>Logic Input Pin</p> <p>1kΩ</p> <p>100kΩ</p> <p>GND</p>
MO	Digital Output (VOH/VOL)  VOH: 2.0V(min)~5.5V(max) VIL : 0V(min)~0.8V(max) (プルアップ抵抗 : 10k~100kΩ)	<p>Logic Input Pin</p> <p>GND</p>
VCC VREFA VREFB	VCC voltage range 4.75V(min)~5.0V(typ)~5.25V(max)  VREF voltage range 0V~3.6V	<p>VCC</p> <p>VREF</p> <p>1kΩ</p> <p>GND</p>
OSCM	OSCM frequency setting range 0.64MHz(min)~1.12MHz(typ)~2.4MHz(max)	<p>OSCM</p> <p>1kΩ</p> <p>500Ω</p> <p>GND</p>
OUTA+ OUTA- OUTB+ OUTB- RSA RSB	VM power supply voltage range 10V(min)~47V(max)  OUTPUT pin voltage 10V(min)~47V(max)	<p>RS</p> <p>OUT+</p> <p>OUT-</p> <p>GND</p>

The equivalent circuit diagrams may be simplified or some parts of them may be omitted for explanatory purposes.

## Function explanation (Stepping motor)

### 1. CLK Function

Each up-edge of the CLK signal will shift the motor's electrical angle per step.

CLK 入力	Function
↑	Shifts the electrical angle per step.
↓	(State of the electrical angle does not change.)

### 2. ENABLE function

The ENABLE pin controls the ON and OFF of the corresponding output stage. This pin serves to select if the motor is stopped in Off (High impedance) mode or activated. Please set the ENABLE pin to 'L' during VM power-on and power-off sequence.

ENABLE 入力	Function
H	Output stage='ON' (Normal operation mode)
L	Output stage='OFF' (High impedance mode)

### 3. CW/CCW function and the output pin function (Output logic at the time of a charge start)

The CW/CCW pin controls the rotation direction of the motor. When set to 'Clockwise', the current of OUTA is output first, with a phase difference of 90 deg. When set to 'Counter clockwise', the current of OUTB is output first with a phase difference of 90 deg.

CW/CCW 入力	OUT (+)	OUT (-)
H : Clockwise operation(CW)	H	L
L : Counter clockwise operation(CCW)	L	H

### 4. Step resolution select function

DMODE1	DMODE2	Function
L	L	Standby mode (the OSCM is disabled and the output stage is set to 'OFF' status)
L	H	Full step resolution
H	L	Half step resolution(Type A)
H	H	Quarter step resolution

When switching the DMODE1,2; setting the RESET signal to Low (will set the electrical angle to the initial status), is recommended.

**Step resolution setting and initial angle**

[Full step resolution]

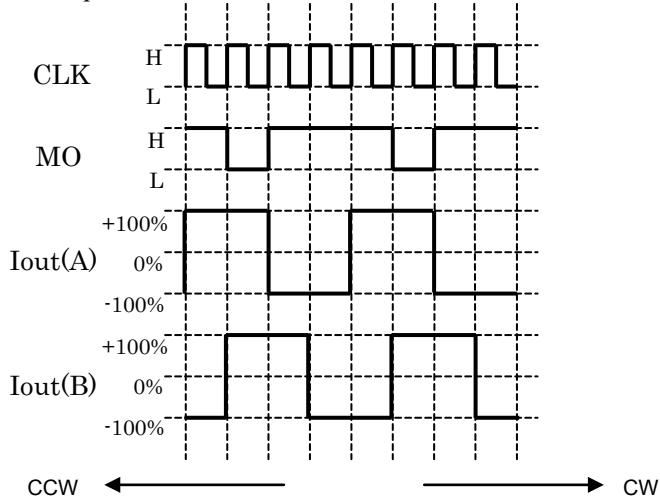

[Half step resolution (Type A)]

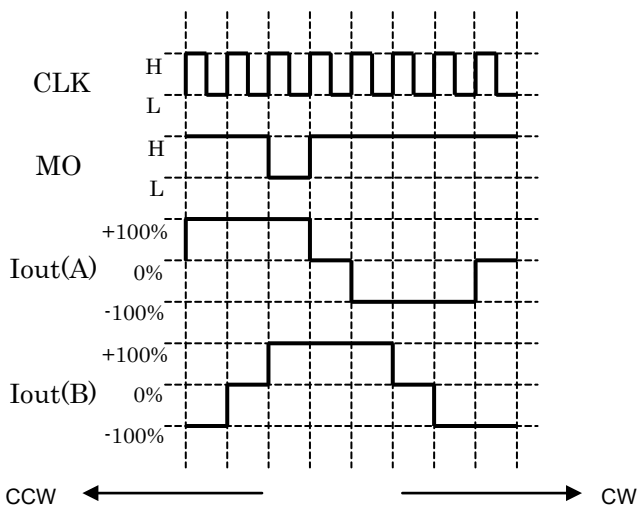

MO output shown in the timing chart is when the MO pin is pulled up.  
Timing charts may be simplified for explanatory purpose.

[Quarter step resolution]

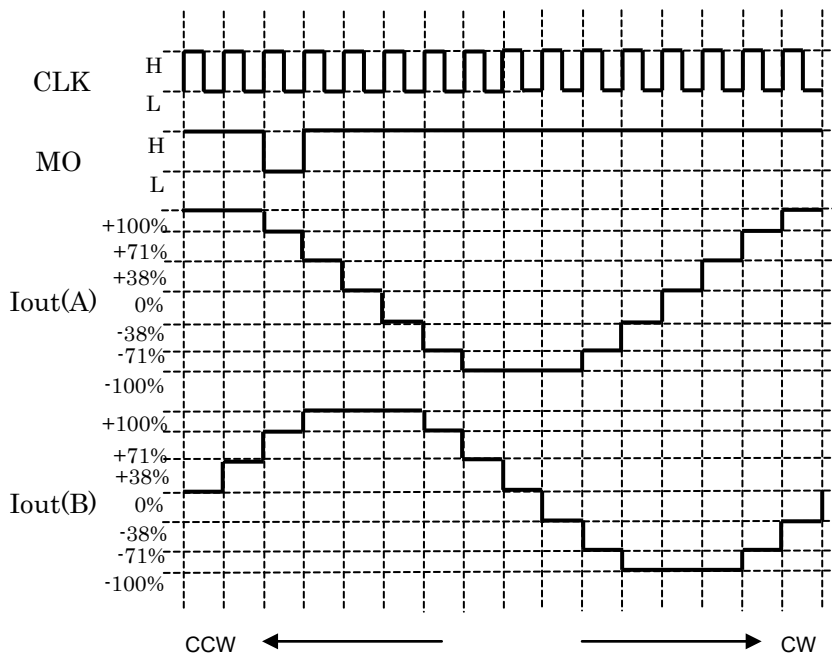

MO output shown in the timing chart is when the MO pin is pulled up. Timing charts may be simplified for explanatory purpose.

### Step setting and current percentage

Current	Full	Half (A)	Quarter
±100%	○	○○○	○○○
±71%			○
±38%			○
0%		○	○

## 5. RESET function

RESET Input	Function
H	Sets the electrical angle to the initial condition.
L	Normal operation mode

The current for each channel (while RESET is applied) is shown in the table below. MO will show 'L' at this time.

Step resolution setting	Ach current setting	Bch current setting	Default electrical angle
Full step	100%	100%	45°
Half step (Type (A))	100%	100%	45°
Quarter step	71%	71%	45°

**6. Decay function**

**ADMD(Advanced Dynamic Mixed Decay) constant current control**

The Advanced Dynamic Mixed Decay threshold, which determines the current ripple level during current feedback control, is a unique value.

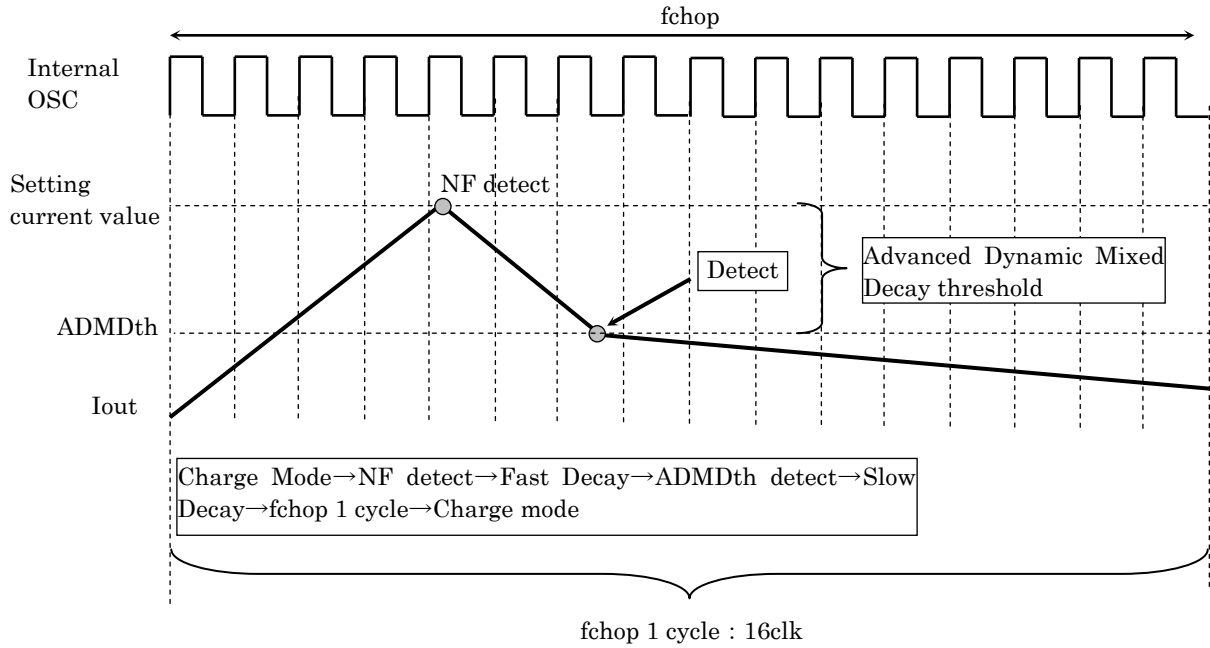

**Auto Decay Mode current waveform**

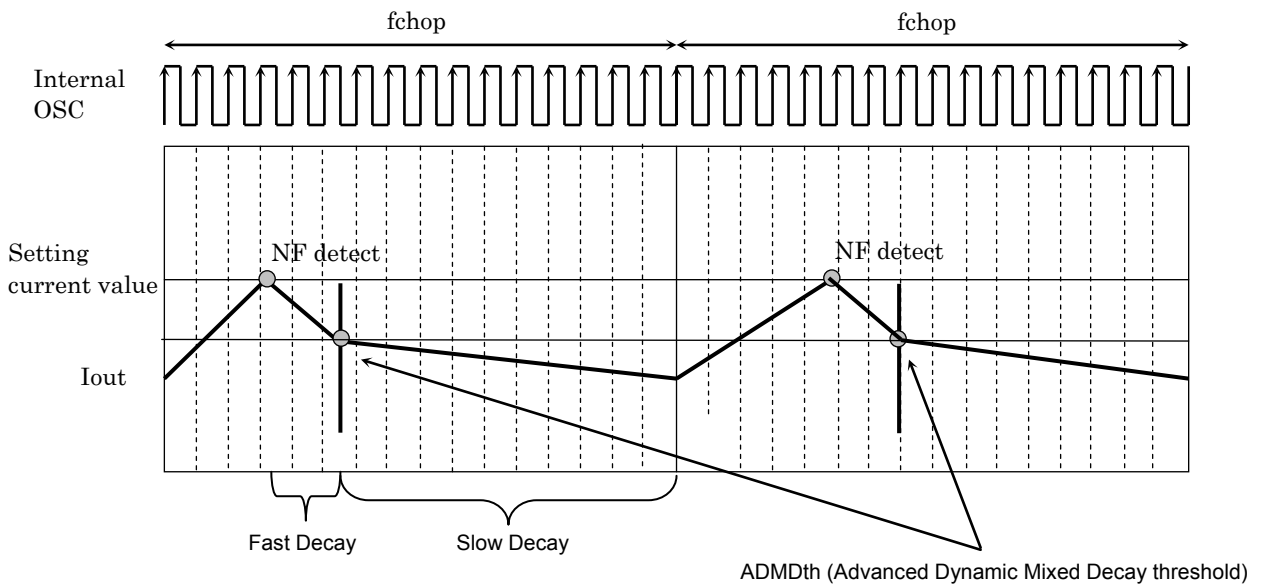

Timing charts may be simplified for explanatory purpose.

## ADMD current waveform

•When the next current step is higher :

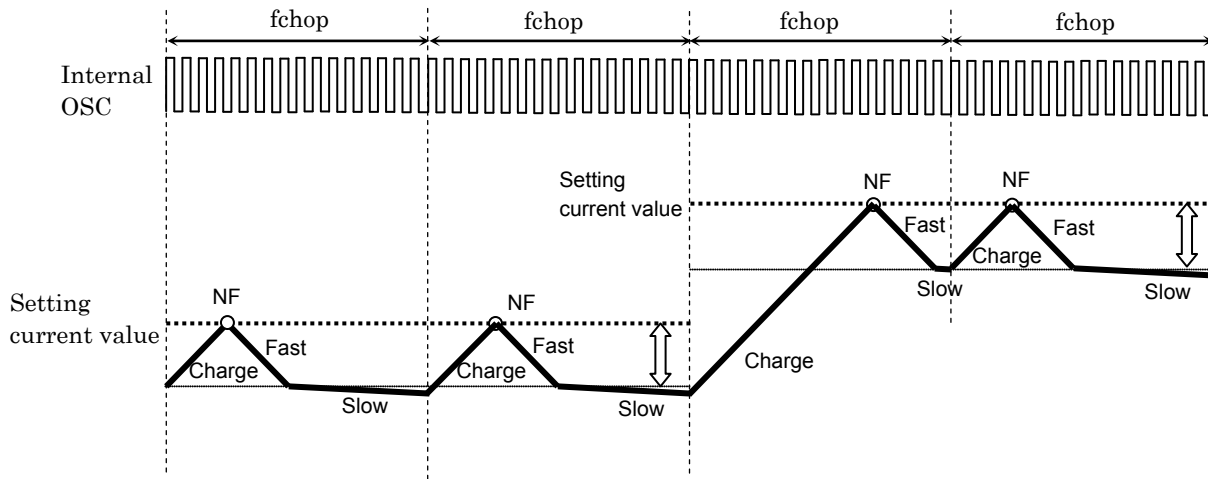

•When Charge period is more than 1 fchop cycle :

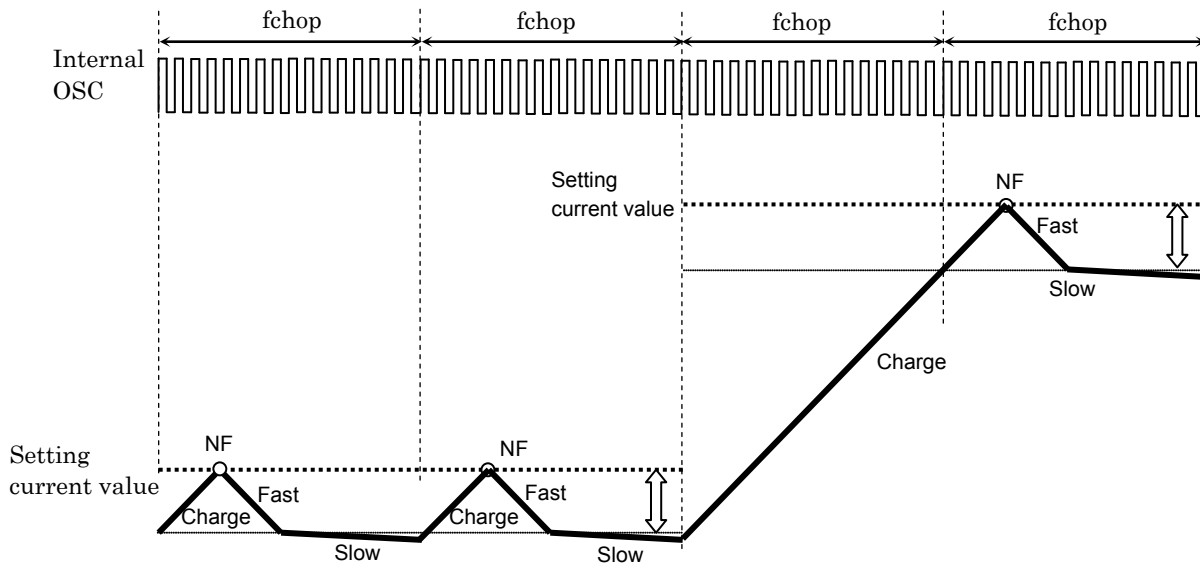

When the Charge period is longer than fchop cycle, the Charge period will be extended until the motor current reaches the NF threshold. Once the current reaches the next current step, then the sequence will go on to decay mode.



•When the next current step is lower :

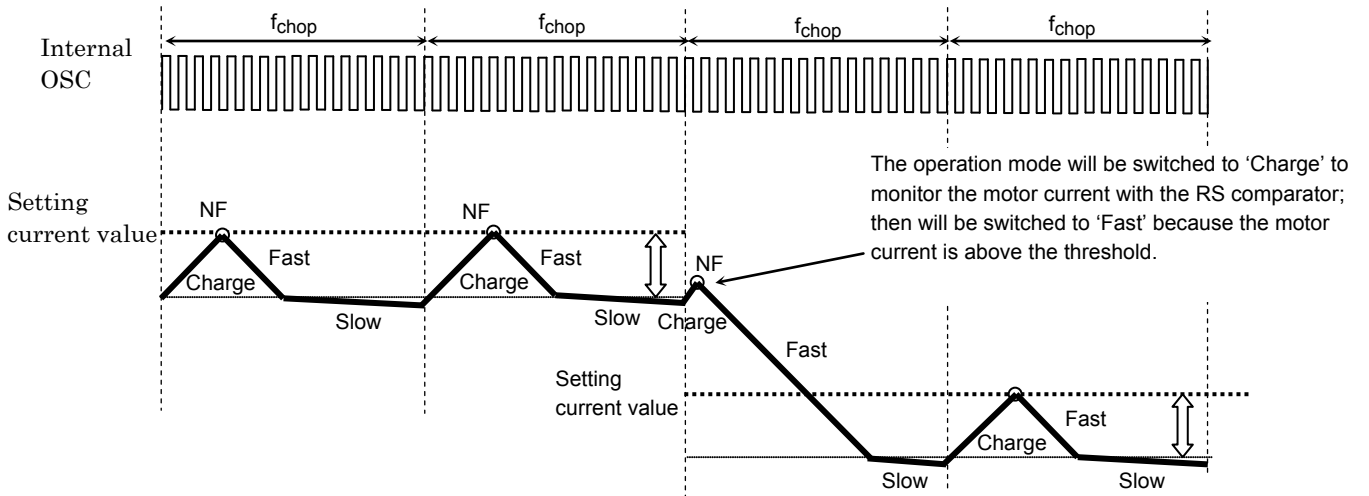

•When the Fast continues past 1  $f_{chop}$  cycle (the motor current not reaching the ADMD threshold during 1  $f_{chop}$  cycle)

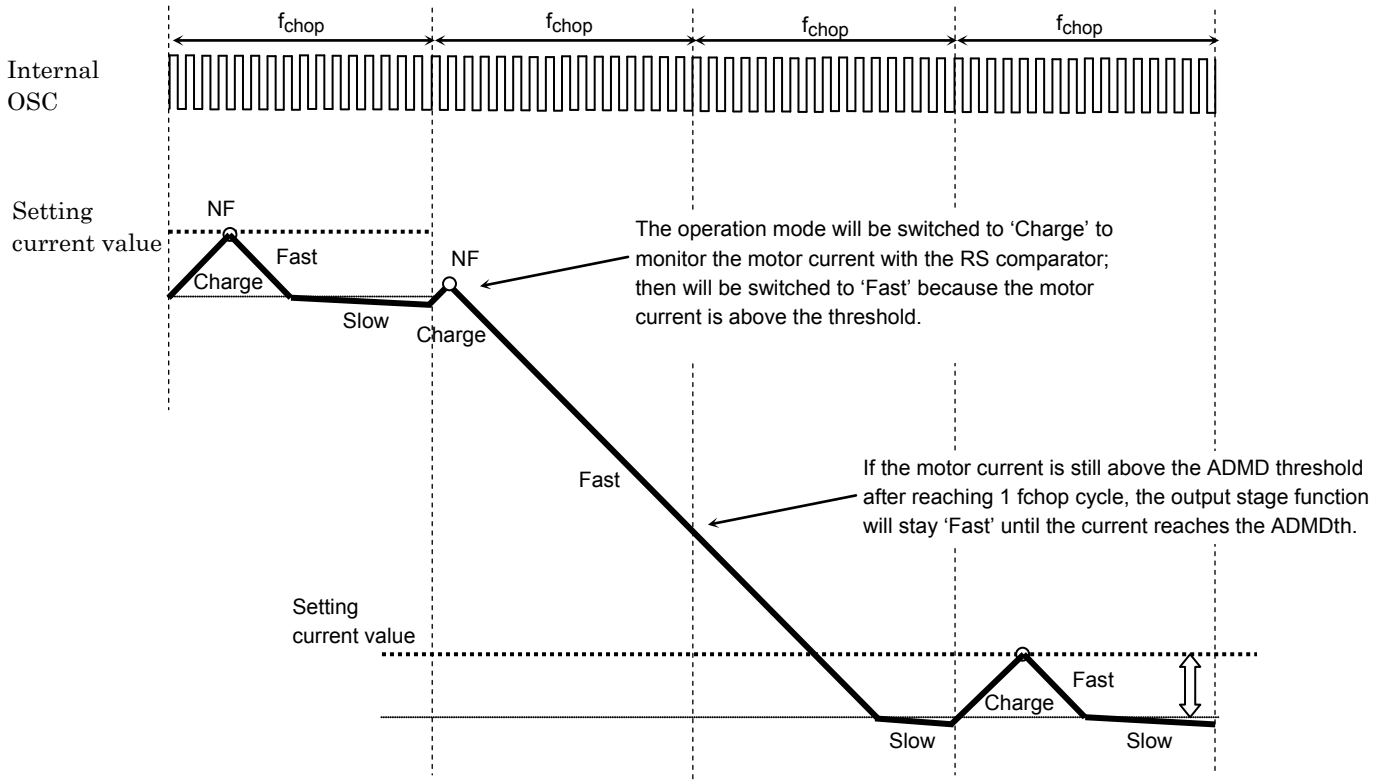

**7. Output transistor function mode**

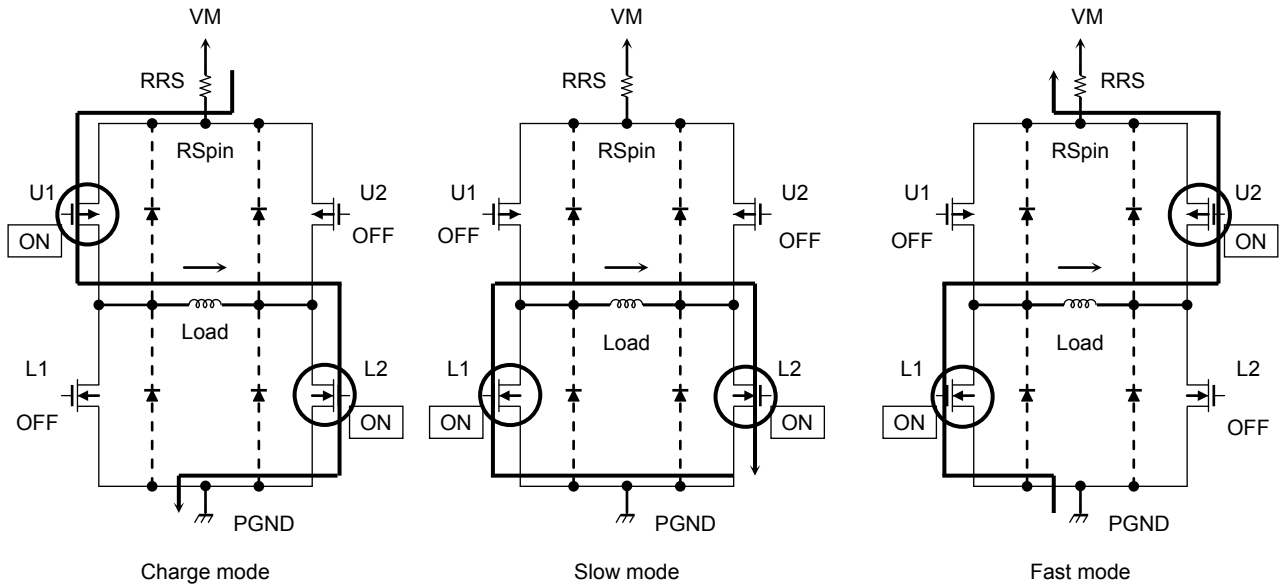

**Output transistor function**

MODE	U1	U2	L1	L2
CHARGE	ON	OFF	OFF	ON
SLOW	OFF	OFF	ON	ON
FAST	OFF	ON	ON	OFF

Note: This table shows an example of when the current flows as indicated by the arrows in the figures shown above. If the current flows in the opposite direction, refer to the following table.

MODE	U1	U2	L1	L2
CHARGE	OFF	ON	ON	OFF
SLOW	OFF	OFF	ON	ON
FAST	ON	OFF	OFF	ON

This IC controls the motor current to be constant by 3 modes listed above.

The equivalent circuit diagrams may be simplified or some parts of them may be omitted for explanatory purposes.

**8. Calculation of the Predefined Output Current**

For PWM constant-current control, this IC uses a clock generated by the OSCM oscillator. The peak output current (Setting current value) can be set via the current-sensing resistor (RS) and the reference voltage (Vref), as follows:

$$I_{out(max)} = V_{ref(gain)} \times \frac{V_{ref(V)}}{R_{RS}(\Omega)}$$

Vref(gain) : the Vref decay rate is 1/ 5.0 (typ.)

For example : In the case of a 100% setup when Vref = 3.0 V, Torque=100%,RS=0.51Ω, the motor constant current (Setting current value) will be calculated as:

$$I_{out} = 3.0V / 5.0 / 0.51\Omega = 1.18 A$$

**9. Calculation of the OSCM oscillation frequency (chopper reference frequency)**

An approximation of the OSCM oscillation frequency (fOSCM) and chopper frequency (fchop) can be calculated by the following expressions.

$$f_{OSCM} = 1 / [0.56 \times \{C \times (R1 + 500)\}]$$

.....C,R1: External components for OSCM (C=270pF , R1=5.1kΩ => About fOSCM =1.12MHz(Typ.))

$$f_{chop} = f_{OSCM} / 16$$

.....fOSCM=1.12MHz => fchop =About 70kHz

If chopping frequency is raised, Rippl of current will become small and wave-like reproducibility will improve. However, the gate loss inside IC goes up and generation of heat becomes large.

By lowering chopping frequency, reduction in generation of heat is expectable. However, Rippl of current may become large. It is a standard about about 70 kHz. A setup in the range of 50 to 100 kHz is recommended.

## Absolute Maximum Ratings (Ta = 25°C)

Characteristics	Symbol	Rating	Unit	Remarks	
Motor power supply	VM	50	V		
Motor output voltage	Vout	50	V		
Motor output current	Iout	4.0	A	Note1	
Internal Logic power supply	VCC	6.0	V	When externally applied.	
Logic input voltage	VIN(H)	6.0	V	-	
	VIN(L)	-0.4	V	-	
MO output voltage	VMO	6.0	V	-	
MO Inflow current	IMO	30	mA	-	
Power dissipation	WQFN48	PD	1.3	W	Note2
	HTSSOP48	PD	1.3	W	Note2
	HSOP28	PD	1.15	W	Note2
Operating temperature	TOPR	-20 to 85	°C	-	
Storage temperature	TSTR	-55 to 150	°C	-	
Junction temperature	Tj(max)	150	°C	-	

Note 1: Usually, the maximum current value at the time should use 70% or less of the absolute maximum ratings for a standard on thermal rating. The maximum output current may be further limited in view of thermal considerations, depending on ambient temperature and board conditions.

Note 2: Device alone (Ta =25°C)

Ta: Ambient temperature

Topr: Ambient temperature while the IC is active

Tj: Junction temperature while the IC is active. The maximum junction temperature is limited by the thermal shutdown (TSD) circuitry. It is advisable to keep the maximum current below a certain level so that the maximum junction temperature, Tj (MAX), will not exceed 120°C.

### Caution) Absolute maximum ratings

The absolute maximum ratings of a semiconductor device are a set of ratings that must not be exceeded, even for a moment. Do not exceed any of these ratings.

Exceeding the rating (s) may cause device breakdown, damage or deterioration, and may result in injury by explosion or combustion.

The value of even one parameter of the absolute maximum ratings should not be exceeded under any circumstances. The TB67S102A does not have overvoltage detection circuit. Therefore, the device is damaged if a voltage exceeding its rated maximum is applied.

All voltage ratings, including supply voltages, must always be followed. The other notes and considerations described later should also be referred to.

## Operation Ranges (Ta=-20 to 85°C)

Characteristics	Symbol	Min	Typ.	Max	Unit	Remarks
Motor power supply	VM	10	24	47	V	
Motor output current	Iout	-	1.5	3.0	A	Note1
Logic input voltage	VIN(H)	2.0	-	5.5	V	Logic input High Level
	VIN(L)	0	-	0.8	V	Logic input Low Level
MO output pin voltage	VMO	-	3.3	5.0	V	
Clock input frequency	fCLK	-	-	100	kHz	
Chopper frequency	fchop(range)	40	70	150	kHz	
Vref input voltage	Vref	GND	2.0	3.6	V	

Note 1: Maximum current for actual usage may be limited by the operating circumstances such as operating conditions (exciting mode, operating time, and so on), ambient temperature, and heat conditions (board condition and so on).

### Electrical Specifications 1 (Ta = 25°C, VM = 24 V, unless specified otherwise)

Characteristics		Symbol	Test condition	Min	Typ.	Max	Unit
Logic input voltage	HIGH	VIN(H)	Logic input pin (*)	2.0	-	5.5	V
	LOW	VIN(L)	Logic input pin (*)	0	-	0.8	V
Logic input hysteresis voltage		VIN(HYS)	Logic input pin (*)	100	-	300	mV
Logic input current	HIGH	IIN(H)	Logic input voltage=3.3V	-	33	-	μA
	LOW	IIN(L)	Logic input voltage=0V	-	-	1	μA
MO output pin voltage		VOL(MO)	IOL=24mA, output=Low	-	0.2	0.5	V
Power consumption		IM1	Output pins=open Standby mode	-	2	3.5	mA
		IM2	Output pins=open Standby release, ENABLE=Low	-	3.5	5.5	mA
		IM3	Output pins=open Full step resolution	-	5.5	7	mA
Output leakage current	High-side	IOH	VRS=VM=50V, Vout=0V	-	-	1	μA
	Low-side	IOL	VRS=VM=Vout=50V	1	-	-	μA
Motor current channel differential		ΔIout1	Current differential between Ch	-5	0	5	%
Motor current setting accuracy		ΔIout2	Iout=1.5A	-5	0	5	%
RS pin current		IRS	VRS=VM=24V	0	-	10	μA
Motor output ON-resistance (High-side+Low-side)		Ron(H+L)	Tj=25°C, Forward direction (High-side+Low-side)	-	0.49	0.6	Ω

Note: VIN (H) is defined as the VIN voltage that causes the outputs (OUT\_A, OUT\_B) to change when a pin under test is gradually raised from 0 V. VIN (L) is defined as the VIN voltage that causes the outputs (OUT\_A, OUT\_B) to change when the pin is then gradually lowered. The difference between VIN (H) and VIN (L) is defined as the input hysteresis.

Note: When the logic signal is applied to the device whilst the VM power supply is not asserted; the device is designed not to function, but for safe usage, please apply the logic signal after the VM power supply is asserted and the VM voltage reaches the proper operating range.

**Electrical Specifications 2 (Ta =25°C, VM = 24 V, unless specified otherwise)**

Characteristics	Symbol	Test condition	Min	Typ.	Max	Unit
Vref input current	Iref	Vref=2.0V	-	0	1	μA
VCC voltage	VCC	ICC=5.0mA	4.75	5.0	5.25	V
VCC current	ICC	VCC=5.0V	-	2.5	5	mA
Vref gain rate	Vref(gain)	Vref=2.0V	1/5.2	1/5.0	1/4.8	—
Thermal shutdown(TSD) threshold (Note1)	TjTSD	—	145	160	175	°C
VM recovery voltage	VMR	—	7.0	8.0	9.0	V
Over-current detection (ISD) threshold (Note2)	ISD	—	4.1	4.9	5.7	A

**Note1: About TSD**

When the junction temperature of the device reached the TSD threshold, the TSD circuit is triggered; the internal reset circuit then turns off the output transistors. Noise rejection blanking time is built-in to avoid misdetection. Once the TSD circuit is triggered, the device will be set to standby mode, and can be cleared by reasserting the VM power source, or setting the DMODE pins to standby mode. The TSD circuit is a backup function to detect a thermal error, therefore is not recommended to be used aggressively.

**Note2: About ISD**

When the output current reaches the threshold, the ISD circuit is triggered; the internal reset circuit then turns off the output transistors. Once the ISD circuit is triggered, the device keeps the output off until power-on reset (POR), is reasserted or the device is set to standby mode by DMODE pins. For fail-safe, please insert a fuse to avoid secondary trouble.

**Back-EMF**

While a motor is rotating, there is a timing at which power is fed back to the power supply. At that timing, the motor current recirculates back to the power supply due to the effect of the motor back-EMF.

If the power supply does not have enough sink capability, the power supply and output pins of the device might rise above the rated voltages. The magnitude of the motor back-EMF varies with usage conditions and motor characteristics. It must be fully verified that there is no risk that the TB67S102A or other components will be damaged or fail due to the motor back-EMF.

**Cautions on Overcurrent Shutdown (ISD) and Thermal Shutdown (TSD)**

The ISD and TSD circuits are only intended to provide temporary protection against irregular conditions such as an output short-circuit; they do not necessarily guarantee the complete IC safety.

If the device is used beyond the specified operating ranges, these circuits may not operate properly: then the device may be damaged due to an output short-circuit.

The ISD circuit is only intended to provide a temporary protection against an output short-circuit. If such a condition persists for a long time, the device may be damaged due to overstress. Overcurrent conditions must be removed immediately by external hardware.

**IC Mounting**

Do not insert devices incorrectly or in the wrong orientation. Otherwise, it may cause breakdown, damage and/or deterioration of the device.

## AC Electrical Specification (Ta = 25°C, VM = 24 V, 6.8 mH/5.7 Ω)

Characteristics	Symbol	Test condition	Min	Typ.	Max	Unit
Inside filter of CLK input minimum High width	tCLK(H)	The CLK(H) minimum pulse width	300	-	-	ns
Inside filter of CLK input minimum Low width	tCLK(L)	The CLK(L) minimum pulse width	250	-	-	ns
Output transistor switching specific	tr	-	30	80	130	ns
	tf	-	40	90	140	ns
	tpLH(CLK)	CLK-Output	-	1000	-	ns
	tpHL(CLK)	CLK-Output	-	1500	-	ns
Analog noise blanking time	AtBLK	VM=24V, IOOUT=1.5A Analog tblank	250	400	550	ns
Oscillator frequency accuracy	ΔfOSCM	COSC=270pF, ROSC=5.1kΩ	-15	-	+15	%
Oscillator reference frequency	fOSCM	COSC=270pF, ROSC=5.1kΩ	952	1120	1288	kHz
Chopping frequency	fchop	Output:Active(IOOUT = 1.5 A), fOSC = 1120 kHz	-	70	-	kHz

## AC Electrical Specification Timing chart

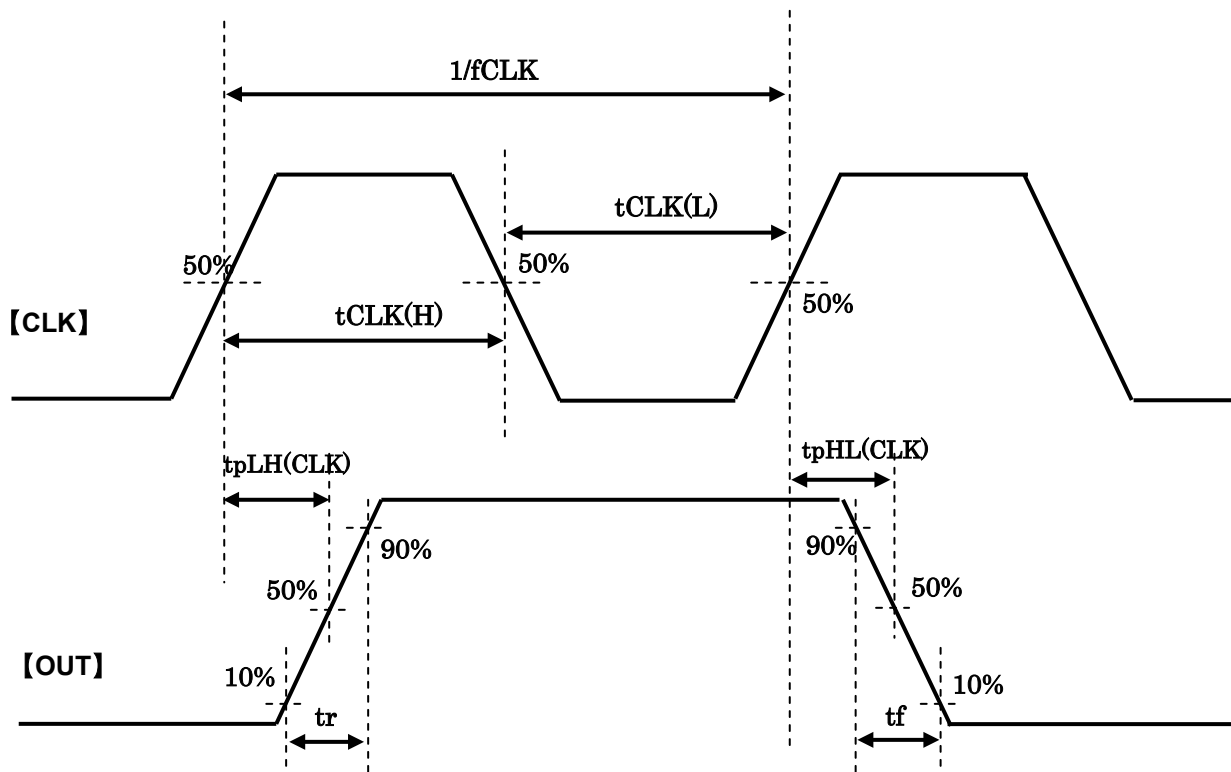

Timing charts may be simplified for explanatory purpose.

**Package Dimensions**

(unit :mm)

**HSOP28-P-0450-0.80**

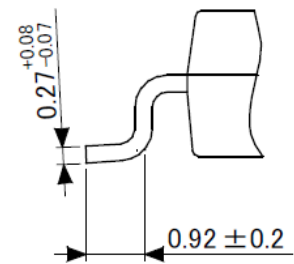
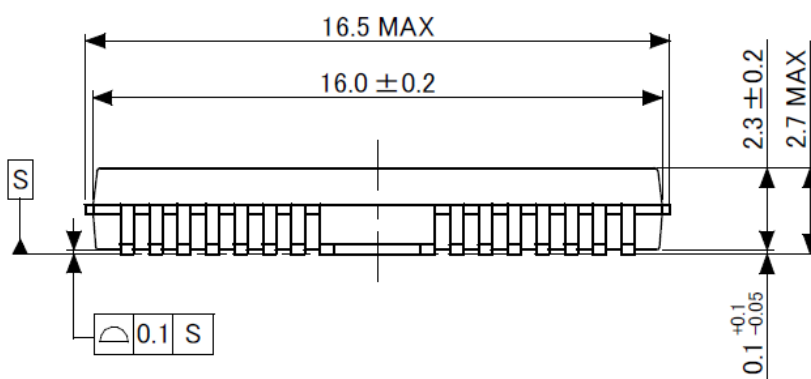
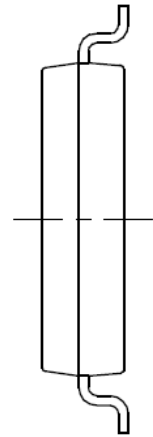
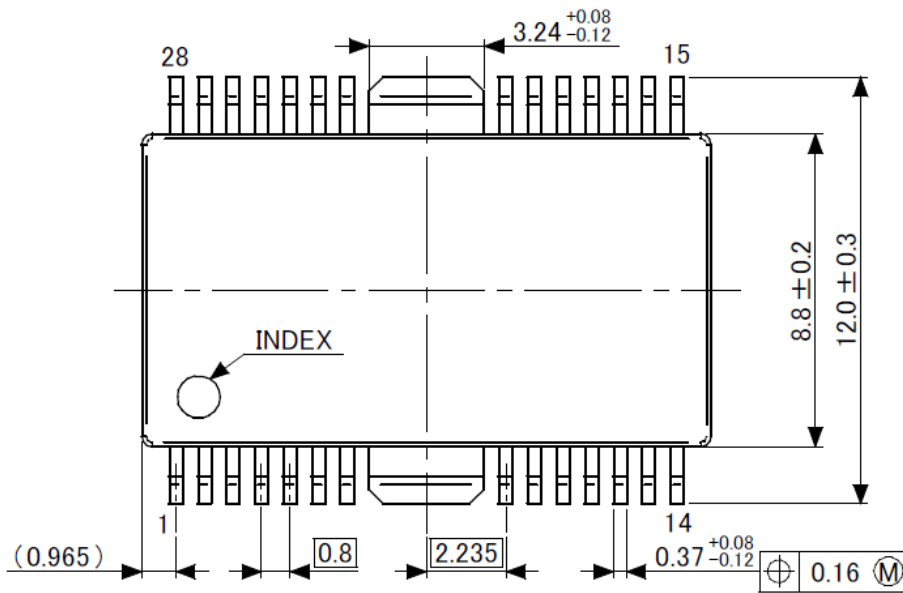



P-WQFN48-0707-0.50-003

(unit :mm)

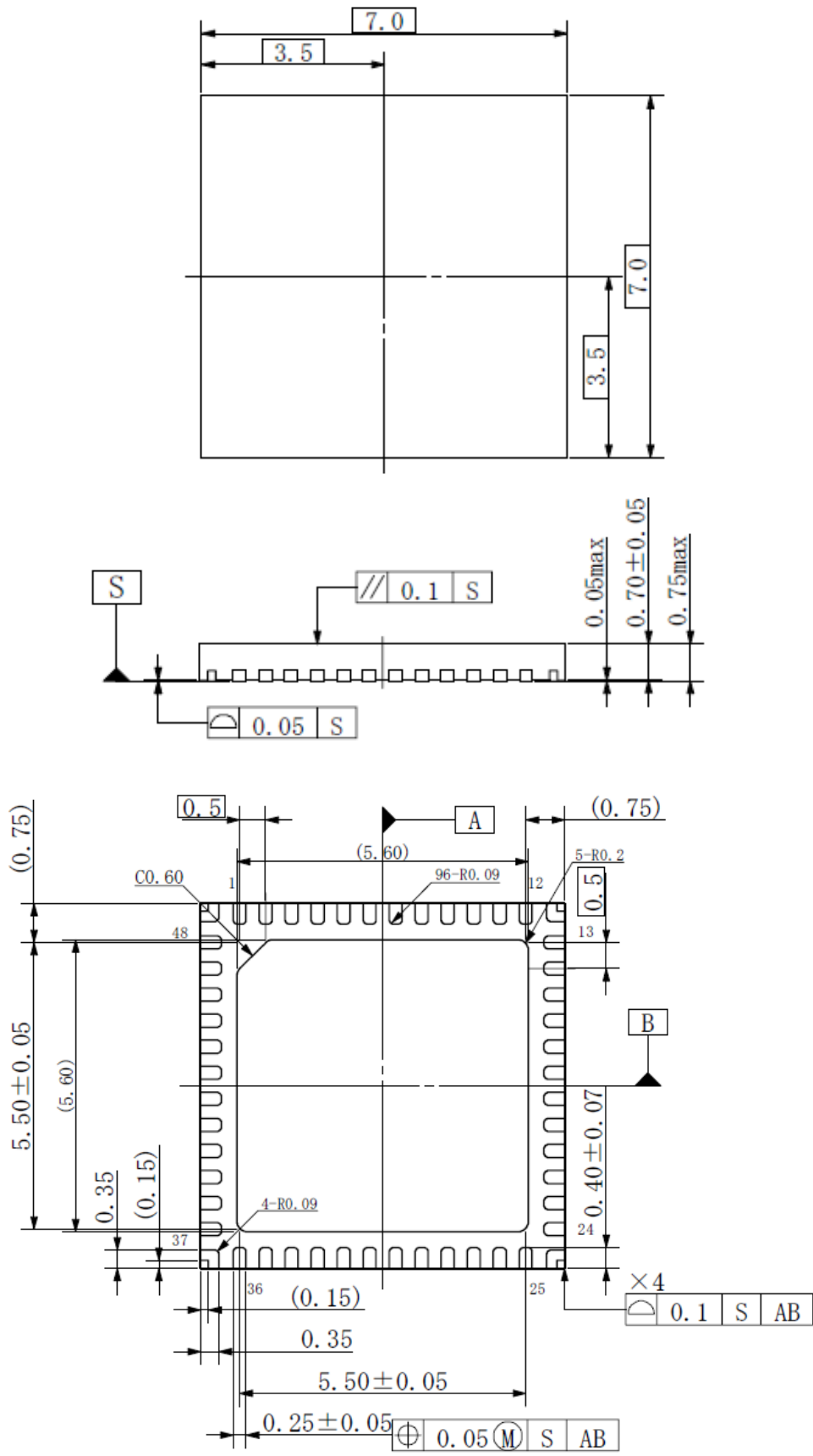

HTSSOP48-P-300-0.50

(unit :mm)

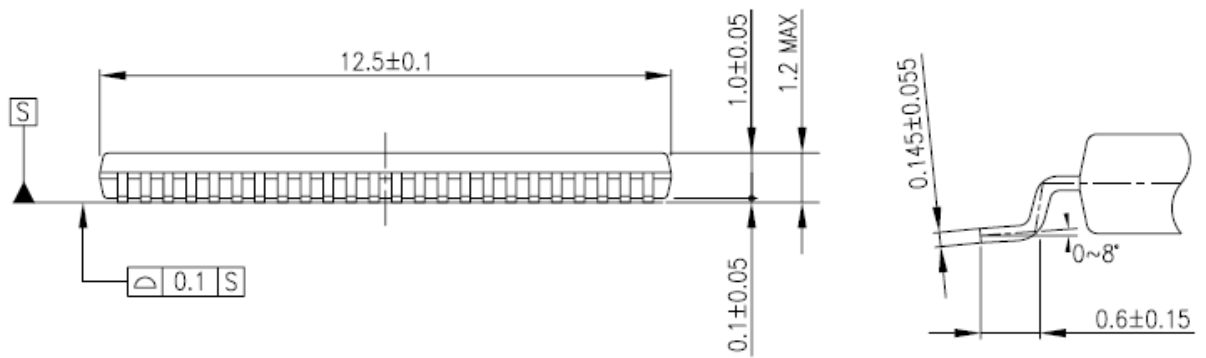
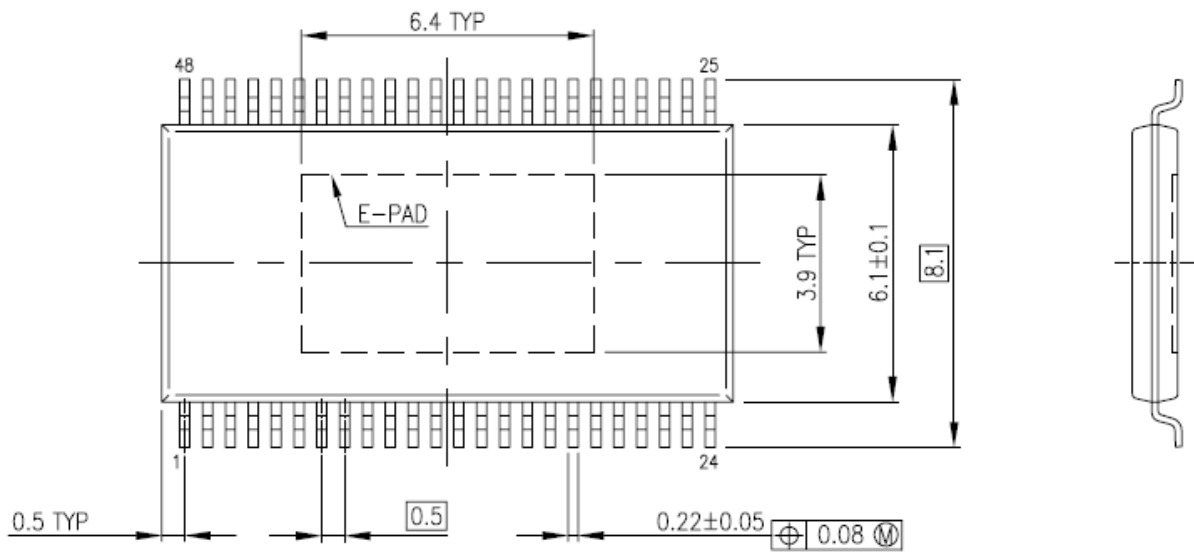

## Notes on Contents

### Block Diagrams

Some of the functional blocks, circuits, or constants in the block diagram may be omitted or simplified for explanatory purposes.

### Equivalent Circuits

The equivalent circuit diagrams may be simplified or some parts of them may be omitted for explanatory purposes.

### Timing Charts

Timing charts may be simplified for explanatory purposes.

### Application Circuits

The application circuits shown in this document are provided for reference purposes only. Thorough evaluation is required, especially at the mass-production design stage.

Toshiba does not grant any license to any industrial property rights by providing these examples of application circuits.

### Test Circuits

Components in the test circuits are used only to obtain and confirm the device characteristics. These components and circuits are not guaranteed to prevent malfunction or failure from occurring in the application equipment.

## IC Usage Considerations

### Notes on handling of ICs

- (1) The absolute maximum ratings of a semiconductor device are a set of ratings that must not be exceeded, even for a moment. Do not exceed any of these ratings. Exceeding the rating(s) may cause device breakdown, damage or deterioration, and may result in injury by explosion or combustion.
- (2) Use an appropriate power supply fuse to ensure that a large current does not continuously flow in the case of overcurrent and/or IC failure. The IC will fully break down when used under conditions that exceed its absolute maximum ratings, when the wiring is routed improperly or when an abnormal pulse noise occurs from the wiring or load, causing a large current to continuously flow and the breakdown can lead to smoke or ignition. To minimize the effects of the flow of a large current in the case of breakdown, appropriate settings, such as fuse capacity, fusing time and insertion circuit location, are required.
- (3) If your design includes an inductive load such as a motor coil, incorporate a protection circuit into the design to prevent device malfunction or breakdown caused by the current resulting from the inrush current at power ON or the negative current resulting from the back electromotive force at power OFF. IC breakdown may cause injury, smoke or ignition. Use a stable power supply with ICs with built-in protection functions. If the power supply is unstable, the protection function may not operate, causing IC breakdown. IC breakdown may cause injury, smoke or ignition.
- (4) Do not insert devices in the wrong orientation or incorrectly. Make sure that the positive and negative terminals of power supplies are connected properly. Otherwise, the current or power consumption may exceed the absolute maximum rating, and exceeding the rating(s) may cause device breakdown, damage or deterioration, and may result in injury by explosion or combustion. In addition, do not use any device inserted in the wrong orientation or incorrectly to which current is applied even just once.
- (5) Carefully select external components (such as inputs and negative feedback capacitors) and load components (such as speakers), for example, power amp and regulator. If there is a large amount of leakage current such as from input or negative feedback condenser, the IC output DC voltage will increase. If this output voltage is connected to a speaker with low input withstand voltage, overcurrent or IC failure may cause smoke or ignition. (The overcurrent may cause smoke or ignition from the IC itself.) In particular, please pay attention when using a Bridge Tied Load (BTL) connection-type IC that inputs output DC voltage to a speaker directly.

## **Points to remember on handling of ICs**

### **Overcurrent detection Circuit**

Overcurrent detection circuits (referred to as current limiter circuits) do not necessarily protect ICs under all circumstances. If the overcurrent detection circuits operate against the overcurrent, clear the overcurrent status immediately.

Depending on the method of use and usage conditions, exceeding absolute maximum ratings may cause the overcurrent detection circuit to operate improperly or IC breakdown may occur before operation. In addition, depending on the method of use and usage conditions, if overcurrent continues to flow for a long time after operation, the IC may generate heat resulting in breakdown.

### **Thermal Shutdown Circuit**

Thermal shutdown circuits do not necessarily protect ICs under all circumstances. If the thermal shutdown circuits operate against the over-temperature, clear the heat generation status immediately.

Depending on the method of use and usage conditions, exceeding absolute maximum ratings may cause the thermal shutdown circuit to operate improperly or IC breakdown to occur before operation.

### **Heat Radiation Design**

When using an IC with large current flow such as power amp, regulator or driver, design the device so that heat is appropriately radiated, in order not to exceed the specified junction temperature (T<sub>J</sub>) at any time or under any condition. These ICs generate heat even during normal use. An inadequate IC heat radiation design can lead to decrease in IC life, deterioration of IC characteristics or IC breakdown. In addition, when designing the device, take into consideration the effect of IC heat radiation with peripheral components.

### **Back-EMF**

When a motor rotates in the reverse direction, stops or slows abruptly, current flows back to the motor's power supply owing to the effect of back-EMF. If the current sink capability of the power supply is small, the device's motor power supply and output pins might be exposed to conditions beyond the absolute maximum ratings. To avoid this problem, take the effect of back-EMF into consideration in system design.

## RESTRICTIONS ON PRODUCT USE

- Toshiba Corporation, and its subsidiaries and affiliates (collectively "TOSHIBA"), reserve the right to make changes to the information in this document, and related hardware, software and systems (collectively "Product") without notice.
- This document and any information herein may not be reproduced without prior written permission from TOSHIBA. Even with TOSHIBA's written permission, reproduction is permissible only if reproduction is without alteration/omission.
- Though TOSHIBA works continually to improve Product's quality and reliability, Product can malfunction or fail. Customers are responsible for complying with safety standards and for providing adequate designs and safeguards for their hardware, software and systems which minimize risk and avoid situations in which a malfunction or failure of Product could cause loss of human life, bodily injury or damage to property, including data loss or corruption. Before customers use the Product, create designs including the Product, or incorporate the Product into their own applications, customers must also refer to and comply with (a) the latest versions of all relevant TOSHIBA information, including without limitation, this document, the specifications, the data sheets and application notes for Product and the precautions and conditions set forth in the "TOSHIBA Semiconductor Reliability Handbook" and (b) the instructions for the application with which the Product will be used with or for. Customers are solely responsible for all aspects of their own product design or applications, including but not limited to (a) determining the appropriateness of the use of this Product in such design or applications; (b) evaluating and determining the applicability of any information contained in this document, or in charts, diagrams, programs, algorithms, sample application circuits, or any other referenced documents; and (c) validating all operating parameters for such designs and applications. **TOSHIBA ASSUMES NO LIABILITY FOR CUSTOMERS' PRODUCT DESIGN OR APPLICATIONS.**
- **PRODUCT IS NEITHER INTENDED NOR WARRANTED FOR USE IN EQUIPMENTS OR SYSTEMS THAT REQUIRE EXTRAORDINARILY HIGH LEVELS OF QUALITY AND/OR RELIABILITY, AND/OR A MALFUNCTION OR FAILURE OF WHICH MAY CAUSE LOSS OF HUMAN LIFE, BODILY INJURY, SERIOUS PROPERTY DAMAGE AND/OR SERIOUS PUBLIC IMPACT ("UNINTENDED USE").** Except for specific applications as expressly stated in this document, Unintended Use includes, without limitation, equipment used in nuclear facilities, equipment used in the aerospace industry, medical equipment, equipment used for automobiles, trains, ships and other transportation, traffic signaling equipment, equipment used to control combustions or explosions, safety devices, elevators and escalators, devices related to electric power, and equipment used in finance-related fields. **IF YOU USE PRODUCT FOR UNINTENDED USE, TOSHIBA ASSUMES NO LIABILITY FOR PRODUCT.** For details, please contact your TOSHIBA sales representative.
- Do not disassemble, analyze, reverse-engineer, alter, modify, translate or copy Product, whether in whole or in part.
- Product shall not be used for or incorporated into any products or systems whose manufacture, use, or sale is prohibited under any applicable laws or regulations.
- The information contained herein is presented only as guidance for Product use. No responsibility is assumed by TOSHIBA for any infringement of patents or any other intellectual property rights of third parties that may result from the use of Product. No license to any intellectual property right is granted by this document, whether express or implied, by estoppel or otherwise.
- **ABSENT A WRITTEN SIGNED AGREEMENT, EXCEPT AS PROVIDED IN THE RELEVANT TERMS AND CONDITIONS OF SALE FOR PRODUCT, AND TO THE MAXIMUM EXTENT ALLOWABLE BY LAW, TOSHIBA (1) ASSUMES NO LIABILITY WHATSOEVER, INCLUDING WITHOUT LIMITATION, INDIRECT, CONSEQUENTIAL, SPECIAL, OR INCIDENTAL DAMAGES OR LOSS, INCLUDING WITHOUT LIMITATION, LOSS OF PROFITS, LOSS OF OPPORTUNITIES, BUSINESS INTERRUPTION AND LOSS OF DATA, AND (2) DISCLAIMS ANY AND ALL EXPRESS OR IMPLIED WARRANTIES AND CONDITIONS RELATED TO SALE, USE OF PRODUCT, OR INFORMATION, INCLUDING WARRANTIES OR CONDITIONS OF MERCHANTABILITY, FITNESS FOR A PARTICULAR PURPOSE, ACCURACY OF INFORMATION, OR NONINFRINGEMENT.**
- Do not use or otherwise make available Product or related software or technology for any military purposes, including without limitation, for the design, development, use, stockpiling or manufacturing of nuclear, chemical, or biological weapons or missile technology products (mass destruction weapons). Product and related software and technology may be controlled under the applicable export laws and regulations including, without limitation, the Japanese Foreign Exchange and Foreign Trade Law and the U.S. Export Administration Regulations. Export and re-export of Product or related software or technology are strictly prohibited except in compliance with all applicable export laws and regulations.
- Please contact your TOSHIBA sales representative for details as to environmental matters such as the RoHS compatibility of Product. Please use Product in compliance with all applicable laws and regulations that regulate the inclusion or use of controlled substances, including without limitation, the EU RoHS Directive. **TOSHIBA ASSUMES NO LIABILITY FOR DAMAGES OR LOSSES OCCURRING AS A RESULT OF NONCOMPLIANCE WITH APPLICABLE LAWS AND REGULATIONS.**

## X-ON Electronics

Largest Supplier of Electrical and Electronic Components

*Click to view similar products for [Motor/Motion/Ignition Controllers & Drivers](#) category:*

*Click to view products by [Toshiba](#) manufacturer:*

Other Similar products are found below :

[FSB50550TB2](#) [FSBF15CH60BTH](#) [MSVCPM2-63-12](#) [MSVGW45-14-2](#) [MSVGW54-14-3](#) [MSVGW54-14-5](#) [NTE7043](#) [LA6565VR-TLM-E](#)  
[LB11650-E](#) [LB1837M-TLM-E](#) [LB1845DAZ-XE](#) [LC898300XA-MH](#) [SS30-TE-L-E](#) [26700](#) [LV8281VR-TLM-H](#) [BA5839FP-E2](#) [IRAM236-1067A](#) [LA6584JA-AH](#) [LB11847L-E](#) [NCV70501DW002R2G](#) [AH293-PL-B](#) [STK672-630CN-E](#) [TND315S-TL-2H](#) [FNA23060](#) [FSB50250AB](#)  
[FNA41060](#) [MSVB54](#) [MSVBTC50E](#) [MSVCPM3-54-12](#) [MSVCPM3-63-12](#) [MSVCPM4-63-12](#) [MSVTA120](#) [FSB50550AB](#)  
[NCV70501DW002G](#) [LC898301XA-MH](#) [LV8413GP-TE-L-E](#) [MSVGW45-14-3](#) [MSVGW45-14-4](#) [MSVGW45-14-5](#) [MSVGW54-14-4](#)  
[STK984-091A-E](#) [MP6519GQ-Z](#) [LB11651-E](#) [IRSM515-025DA4](#) [LV8127T-TLM-H](#) [MC33812EKR2](#) [NCP81382MNTXG](#) [TDA21801](#)  
[LB11851FA-BH](#) [NCV70627DQ001R2G](#)