

TOSHIBA BiCD Integrated Circuit Silicon Monolithic

## TBD62502APG, TBD62502AFG, TBD62502AFNG, TBD62502AFWG TBD62503APG, TBD62503AFG, TBD62503AFNG, TBD62503AFWG

### 7channel sink type DMOS transistor array

TBD62502A series and TBD62503A series are DMOS transistor array with 7 circuits. Please be careful about thermal conditions during use.

#### Features

- 7 circuits built-in
- High voltage :  $V_{OUT} = 50\text{ V (MAX)}$
- High current :  $I_{OUT} = 300\text{ mA/ch (MAX)}$
- Input voltage(output on) : TBD62502A series 14 V (MIN)  
TBD62503A series 2.5 V (MIN)
- Input voltage(output off) : TBD62502A series 7.0 V (MAX)  
TBD62503A series 0.6 V (MAX)
- Package : PG type DIP16-P-300-2.54A  
FG type SOP16-P-225-1.27  
FNG type SSOP16-P-225-0.65B  
FWG type P-SOP16-0410-1.27-002

#### Pin connection (top view)

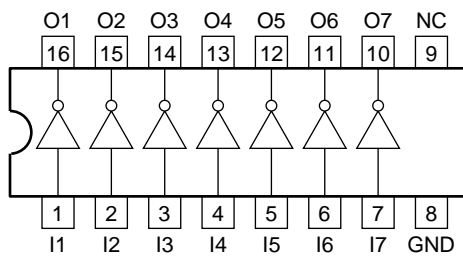

Pin connection may be simplified for explanatory purpose.

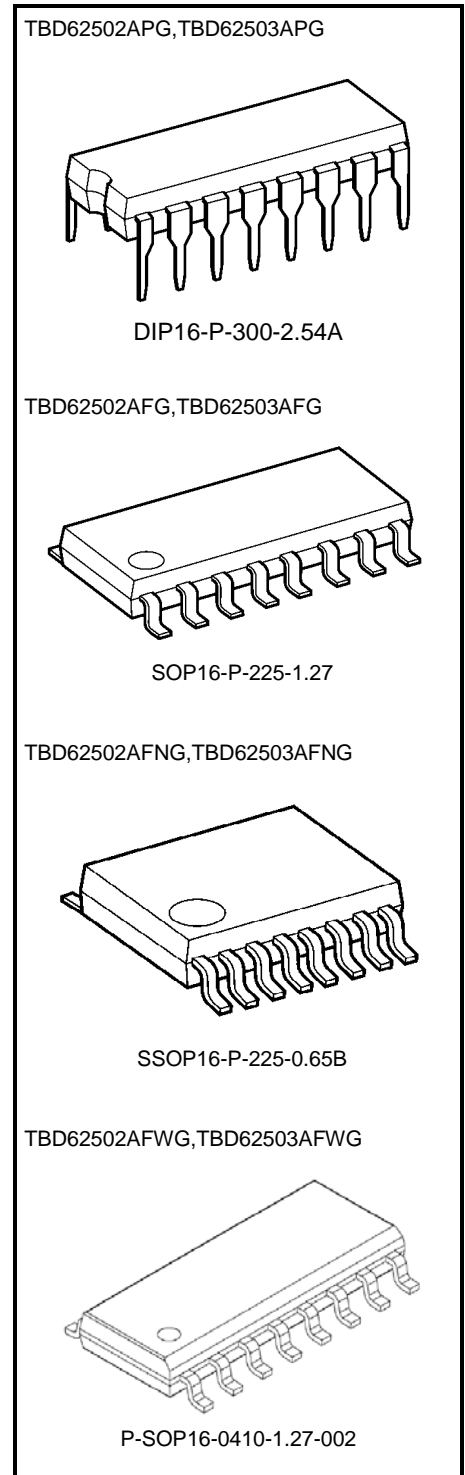

Weight	
DIP16-P-300-2.54A	: 1.11g (Typ.)
SOP16-P-225-1.27	: 0.16g (Typ.)
SSOP16-P-225-0.65B	: 0.07g (Typ.)
P-SOP16-0410-1.27-002	: 0.15g (Typ.)

## Pin explanations

Pin No.	Pin name	Function
1	I1	Input pin
2	I2	Input pin
3	I3	Input pin
4	I4	Input pin
5	I5	Input pin
6	I6	Input pin
7	I7	Input pin
8	GND	GND pin
9	NC	Non-connection pin
10	O7	Output pin
11	O6	Output pin
12	O5	Output pin
13	O4	Output pin
14	O3	Output pin
15	O2	Output pin
16	O1	Output pin

## Equivalent circuit (each driver)

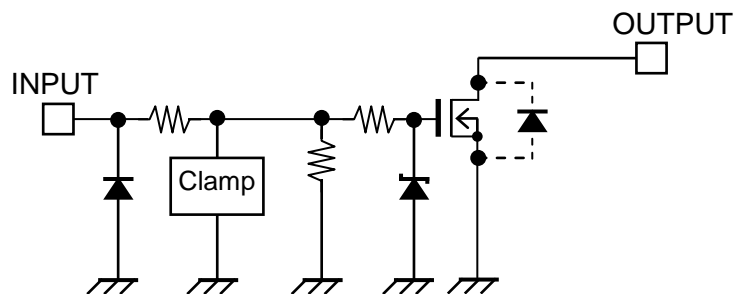

Equivalent circuit may be simplified for explanatory purpose.

## Absolute Maximum Ratings (Ta = 25°C)

Characteristics		Symbol	Rating	Unit
Output voltage		V <sub>OUT</sub>	50	V
Output current		I <sub>OUT</sub>	300	mA/ch
Input voltage		V <sub>IN</sub>	-0.5 to 30	V
Power dissipation	PG (Note 1)	P <sub>D</sub>	1.47	W
	FG (Note 2)		0.625	
	FNG (Note 3)		0.78	
	FWG (Note 4)		1.25	
Operating temperature		T <sub>opr</sub>	-40 to 85	°C
Storage temperature		T <sub>stg</sub>	-55 to 150	°C

Note 1: Device alone. When Ta exceeds 25°C, it is necessary to do the derating with 11.8 mW/°C.

Note 2: On PCB (Size: 30 mm × 30 mm × 1.6 mm, Cu area: 50%, single-side glass epoxy).

When Ta exceeds 25°C, it is necessary to do the derating with 5 mW/°C.

Note 3: On PCB (Size: 50 mm × 50 mm × 1.6 mm, Cu area: 40%, single-side glass epoxy).

When Ta exceeds 25°C, it is necessary to do the derating with 6.24 mW/°C.

Note 4: On PCB (JEDEC 2s2p).

When Ta exceeds 25°C, it is necessary to do the derating with 10 mW/°C.

## Operating Ranges (Ta = -40 to 85 °C)

Characteristics		Symbol	Condition	Min	Typ.	Max	Unit	
Output voltage		V <sub>OUT</sub>	—	—	—	50	V	
Output current	PG(Note 1)	I <sub>OUT</sub>	1 circuits ON, Ta = 25 °C	0	—	250	mA/ch	
			t <sub>pw</sub> = 25 ms 7 circuits ON Ta = 85 °C T <sub>j</sub> = 120 °C	Duty = 10 %	0	—		250
				Duty = 50 %	0	—		190
			FG(Note 2)	1 circuits ON, Ta = 25 °C	0	—		250
	t <sub>pw</sub> = 25 ms 7 circuits ON Ta = 85 °C T <sub>j</sub> = 120 °C			Duty = 10 %	0	—		250
				Duty = 50 %	0	—		120
	FNG(Note 3)			1 circuits ON, Ta = 25 °C	0	—		250
			t <sub>pw</sub> = 25 ms 7 circuits ON Ta = 85 °C T <sub>j</sub> = 120 °C	Duty = 10 %	0	—		250
		Duty = 50 %		0	—	130		
		FWG(Note 4)	1 circuits ON, Ta = 25 °C	0	—	250		
	t <sub>pw</sub> = 25 ms 7 circuits ON Ta = 85 °C T <sub>j</sub> = 120 °C		Duty = 10 %	0	—	250		
			Duty = 50 %	0	—	170		
Input voltage (Output on)	TBD62502A series		V <sub>IN</sub> (ON)	I <sub>OUT</sub> = 100 mA or upper, V <sub>OUT</sub> = 2 V	14	—	25	V
	TBD62503A series	I <sub>OUT</sub> = 100 mA or upper, V <sub>OUT</sub> = 2 V		2.5	—	25		
Input voltage (Output off)	TBD62502A series	V <sub>IN</sub> (OFF)	I <sub>OUT</sub> = 100 μA or less, V <sub>OUT</sub> = 2 V	0	—	7.0	V	
	TBD62503A series		I <sub>OUT</sub> = 100 μA or less, V <sub>OUT</sub> = 2 V	0	—	0.6		

Note 1: Device alone.

Note 2: On PCB (Size: 30 mm × 30 mm × 1.6 mm, Cu area: 50%, single-side glass epoxy).

Note 3: On PCB (Size: 50 mm × 50 mm × 1.6 mm, Cu area: 40%, single-side glass epoxy).

Note 4: On PCB (JEDEC 2s2p).

**Electrical Characteristics (Ta = 25 °C unless otherwise noted)**

Characteristics		Symbol	Test Circuit	Condition	Min	Typ.	Max	Unit
Output leakage current		I <sub>leak</sub>	1	V <sub>OUT</sub> = 50V, Ta = 85 °C V <sub>IN</sub> = 0 V	—	—	1.0	μA
Output voltage (Output ON-resistance)	TBD62502A series	V <sub>DS</sub> (R <sub>ON</sub> )	2	I <sub>OUT</sub> = 200 mA, V <sub>IN</sub> = 14 V	—	0.4 (2.0)	0.65 (3.25)	V (Ω)
				I <sub>OUT</sub> = 100 mA, V <sub>IN</sub> = 14 V	—	0.2 (2.0)	0.325 (3.25)	
	TBD62503A series			I <sub>OUT</sub> = 200 mA, V <sub>IN</sub> = 5.0 V	—	0.4 (2.0)	0.65 (3.25)	
				I <sub>OUT</sub> = 100 mA, V <sub>IN</sub> = 5.0 V	—	0.2 (2.0)	0.325 (3.25)	
Input current (Output on)	TBD62502A series	I <sub>IN</sub> (ON)	3	V <sub>IN</sub> = 14 V	—	—	1.0	mA
	TBD62503A series			V <sub>IN</sub> = 2.5 V	—	—	0.1	
Input current(Output off)		I <sub>IN</sub> (OFF)	4	V <sub>IN</sub> = 0 V, Ta = 85°C	—	—	1.0	μA
Input voltage (Output on)	TBD62502A series	V <sub>IN</sub> (ON)	5	I <sub>OUT</sub> = 100 mA, V <sub>OUT</sub> = 2 V	—	—	14	V
	TBD62503A series				—	—	2.5	
Turn-on delay		t <sub>ON</sub>	6	V <sub>OUT</sub> = 50 V R <sub>L</sub> = 200 Ω C <sub>L</sub> = 15 pF	—	0.4	—	μs
Turn-off delay		t <sub>OFF</sub>			—	0.8	—	

## Test circuit

### 1. $I_{leak}$

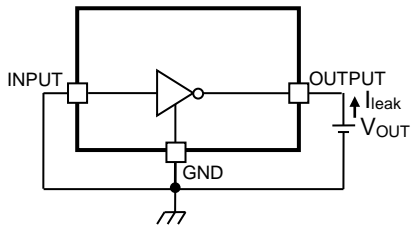

### 2. $V_{DS} (R_{ON})$

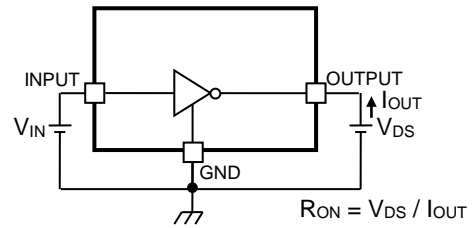

### 3. $I_{IN} (ON)$

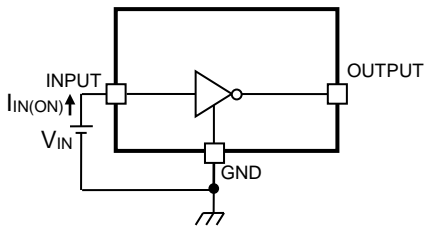

### 4. $I_{IN} (OFF)$

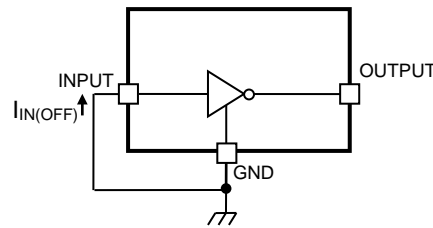

### 5. $V_{IN} (ON)$

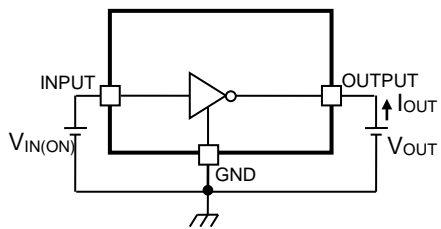

Test circuit may be simplified for explanatory purpose.

**6. t<sub>ON</sub>, t<sub>OFF</sub>**

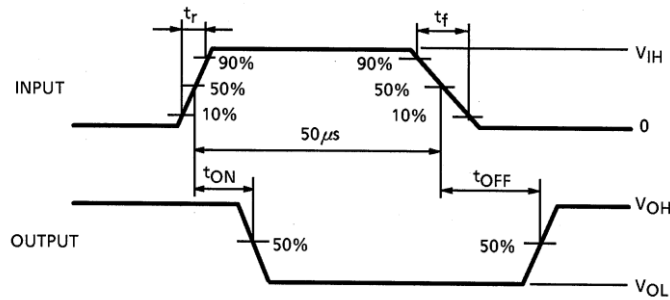
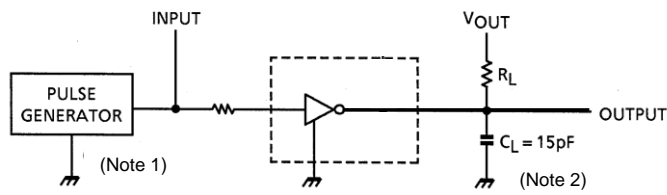

Note 1: Pulse width 50 µs, Duty cycle 10%

Output impedance 50 Ω, tr ≤ 5 ns, tf ≤ 10 ns  
Please refer to the following table for the VIH condition.

Product	VIH
TBD62502A series	14.0 V
TBD62503A series	5.0 V

Note 2: CL includes the probe and the test board capacitance.

Test circuit and timing chart may be simplified for explanatory purpose.

**Precautions for Using**

This IC does not include built-in protection circuits for excess current or overvoltage. If this IC is subjected to excess current or overvoltage, it may be destroyed. Hence, the utmost care must be taken when systems which incorporate this IC are designed. Utmost care is necessary in the design of the output line, COMMON and GND line since IC may be destroyed due to short-circuit between outputs, air contamination fault, or fault by improper grounding.

**Package Dimensions**

DIP16-P-300-2.54A

Unit: mm

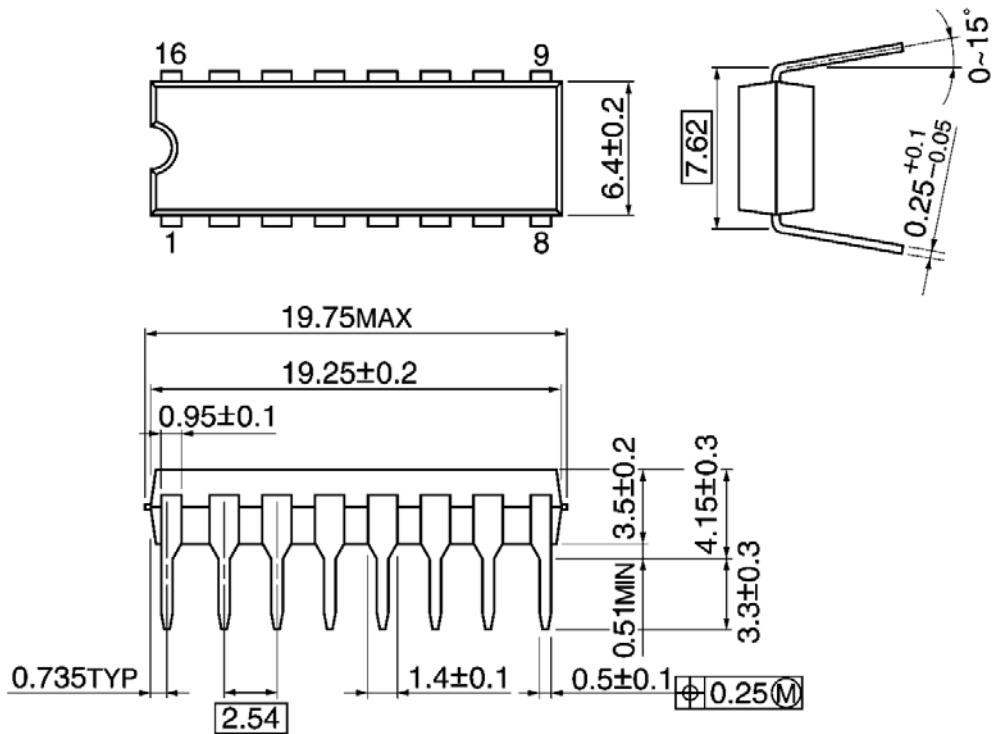

Weight: 1.11 g (Typ.)

SOP16-P-225-1.27

Unit: mm

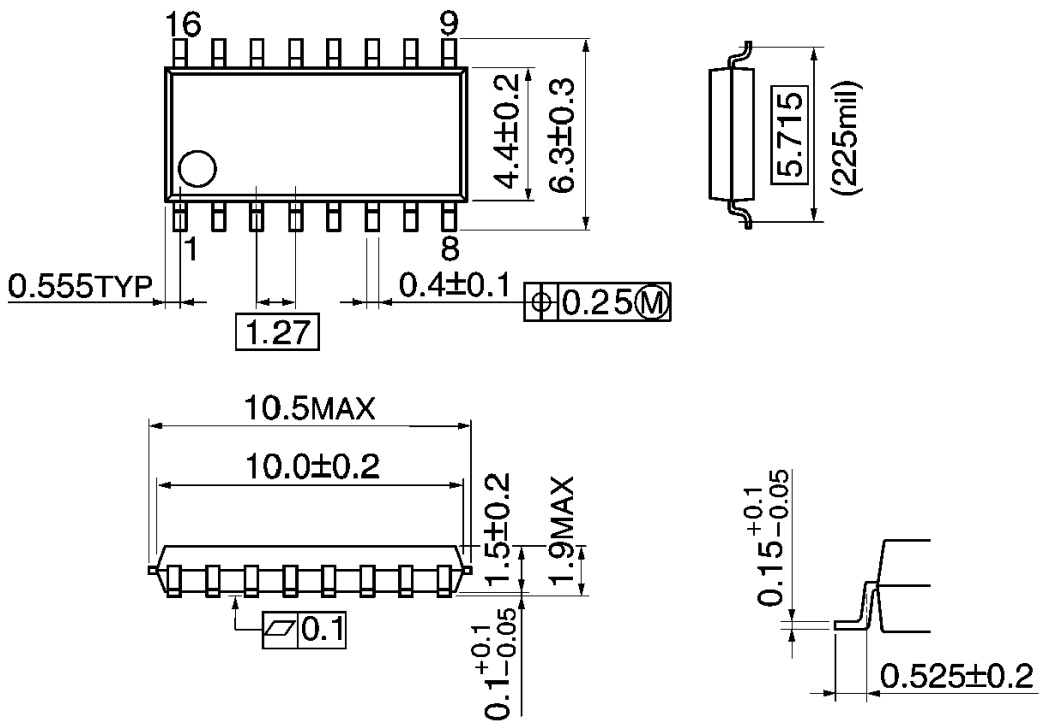

Weight: 0.16 g (Typ.)



SSOP16-P-225-0.65B

Unit: mm

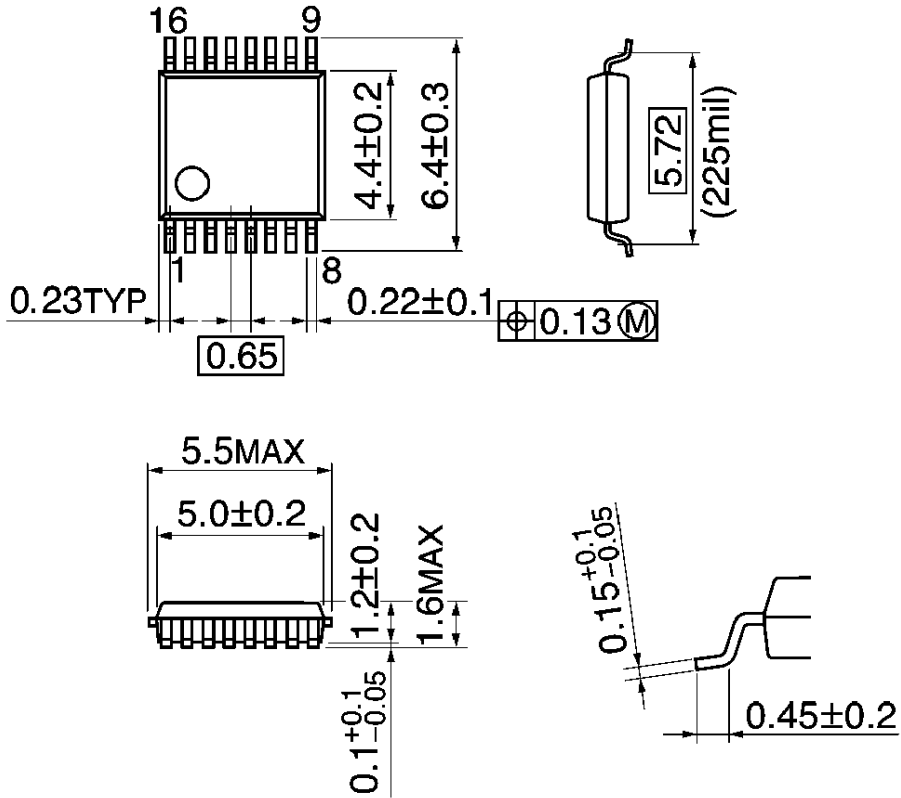

Weight: 0.07 g (Typ.)

P-SOP16-0410-1.27-002

Unit: mm

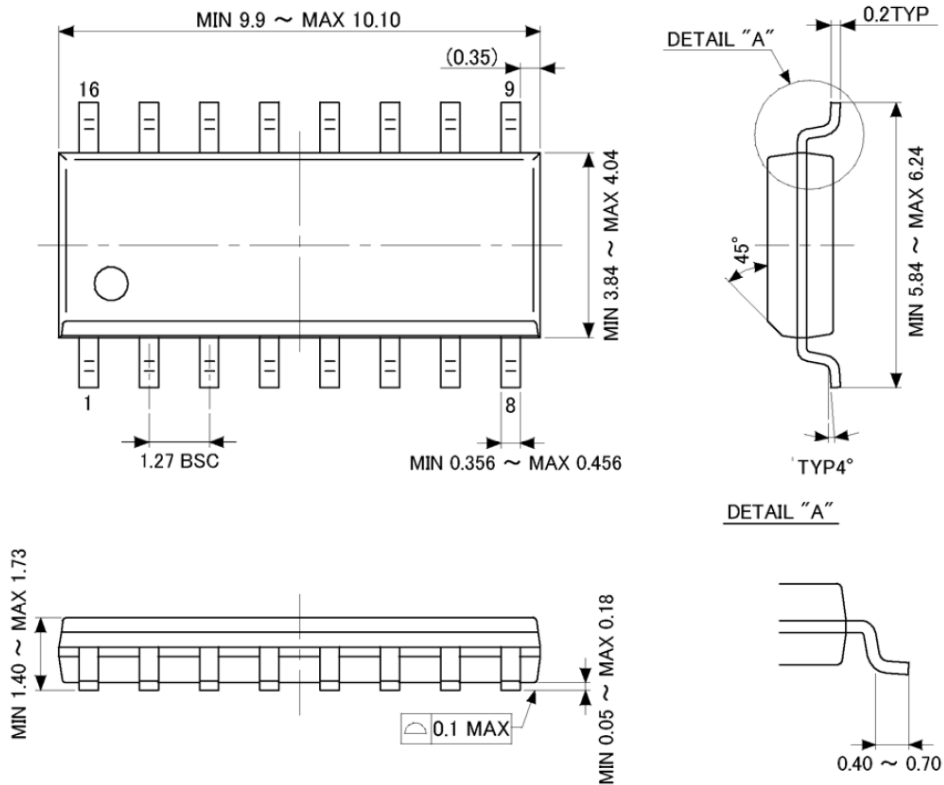

Weight: 0.15 g (Typ.)

## Notes on Contents

### 1. Pin connection

Pin connection may be simplified for explanatory purpose.

### 2. Equivalent Circuits

Equivalent circuit may be simplified for explanatory purpose.

### 3. Test circuit

Test circuit may be simplified for explanatory purpose.

### 4. Timing chart

Timing charts may be simplified for explanatory purposes.

## IC Usage Considerations

### Notes on handling of ICs

- (1) The absolute maximum ratings of a semiconductor device are a set of ratings that must not be exceeded, even for a moment. Do not exceed any of these ratings. Exceeding the rating(s) may cause device breakdown, damage or deterioration, and may result in injury by explosion or combustion.
- (2) Do not insert devices in the wrong orientation or incorrectly. Make sure that the positive and negative terminals of power supplies are connected properly. Otherwise, the current or power consumption may exceed the absolute maximum rating, and exceeding the rating(s) may cause device breakdown, damage or deterioration, and may result in injury by explosion or combustion. In addition, do not use any device inserted in the wrong orientation or incorrectly to which current is applied even just once.
- (3) Use an appropriate power supply fuse to ensure that a large current does not continuously flow in the case of overcurrent and/or IC failure. The IC will fully break down when used under conditions that exceed its absolute maximum ratings, when the wiring is routed improperly or when an abnormal pulse noise occurs from the wiring or load, causing a large current to continuously flow and the breakdown can lead to smoke or ignition. To minimize the effects of the flow of a large current in the case of breakdown, appropriate settings, such as fuse capacity, fusing time and insertion circuit location, are required.
- (4) If your design includes an inductive load such as a motor coil, incorporate a protection circuit into the design to prevent device malfunction or breakdown caused by the current resulting from the inrush current at power ON or the negative current resulting from the back electromotive force at power OFF. IC breakdown may cause injury, smoke or ignition. Use a stable power supply with ICs with built-in protection functions. If the power supply is unstable, the protection function may not operate, causing IC breakdown. IC breakdown may cause injury, smoke or ignition.
- (5) Carefully select external components (such as inputs and negative feedback capacitors) and load components (such as speakers), for example, power amp and regulator. If there is a large amount of leakage current such as from input or negative feedback condenser, the IC output DC voltage will increase. If this output voltage is connected to a speaker with low input withstand voltage, overcurrent or IC failure may cause smoke or ignition. (The overcurrent may cause smoke or ignition from the IC itself.) In particular, please pay attention when using a Bridge Tied Load (BTL) connection-type IC that inputs output DC voltage to a speaker directly.

## Points to remember on handling of ICs

### Heat Radiation Design

When using an IC with large current flow such as power amp, regulator or driver, design the device so that heat is appropriately radiated, in order not to exceed the specified junction temperature (T<sub>J</sub>) at any time or under any condition. These ICs generate heat even during normal use. An inadequate IC heat radiation design can lead to decrease in IC life, deterioration of IC characteristics or IC breakdown. In addition, when designing the device, take into consideration the effect of IC heat radiation with peripheral components.

### Back-EMF

When a motor rotates in the reverse direction, stops or slows abruptly, current flows back to the motor's power supply owing to the effect of back-EMF. If the current sink capability of the power supply is small, the device's motor power supply and output pins might be exposed to conditions beyond the absolute maximum ratings. To avoid this problem, take the effect of back-EMF into consideration in system design.

## X-ON Electronics

Largest Supplier of Electrical and Electronic Components

*Click to view similar products for [Darlington Transistors](#) category:*

*Click to view products by [Toshiba](#) manufacturer:*

Other Similar products are found below :

[BDV64B](#) [2N6298](#) [NJVMJD117T4G](#) [2N6053](#) [MPSA63](#) [NTE256](#) [TIP120](#) [MJ11028](#) [TIP127](#) [Jantx2N6352](#) [2N6301](#) [NJVBUB323ZT4G](#)  
[ULN2803QN](#) [KID65004AF-EL/P](#) [ULN2803CDWR](#) [MJ11033G-JSM](#) [MMBTA64](#) [TPM2003-SO3R](#) [KSP13](#) [TIP127](#) [TIP122](#) [TIP122F](#)  
[TIP122-JSM](#) [ULN2003A-JSM](#) [MJ11032G-JSM](#) [KID65783BF-EL/P](#) [ULN2001D\(MS\)](#) [2SD1071](#) [TIP160](#) [2N6287](#) [MJ3001](#) [MJ2501](#)  
[ULN2001D\(UMW\)](#) [ULN2003APWR\(UMW\)](#) [ULN2003AIPWR\(UMW\)](#) [ULN2002D\(UMW\)](#) [ULN2803G-P20-R](#) [WD2002](#)  
[AIP2003LSA16.TB](#) [AIP2803SA.TR](#) [AIP2803](#) [AIP2803LSA18.TB](#) [XL2803CD](#) [ULN2004MT/TR](#) [MMBTA13](#) [MJD127](#) [ULN2003IPWRG](#)  
[ULN2803ADWMRG](#) [MC1413DRG](#) [ULN2003LVDRG](#)