

TOSHIBA CMOS Linear Integrated Circuit Silicon Monolithic

TC75S59F, TC75S59FU

Single Comparator

The TC75S59F/TC75S59FU is a CMOS general-purpose single comparator. The device can operate off a single power supply and draws a lower supply current than a conventional bipolar general-purpose comparator. This device's open-drain output stage can be wire-ORed with those of other open-drain output circuits.

Features

- Low-current power supply : $I_{DD} = 100 \mu\text{A}$ (typ.)
- Single power supply operation : $V_{DD} = \pm 0.9$ to ± 3.5 V or 1.8 to 7 V
- Wide common mode input voltage range : V_{SS} to $V_{DD} - 0.9$ V
- Open drain output circuit
- Low input bias current
- Small package

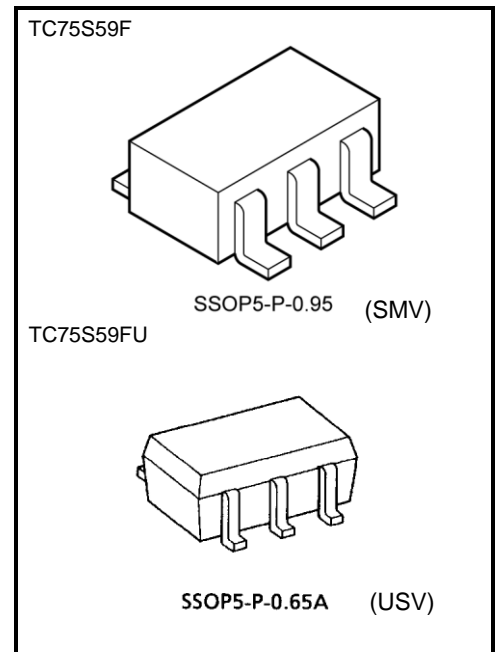

Weight
 SSOP5-P-0.95 : 0.014 g (typ.)
 SSOP5-P-0.65A : 0.006 g (typ.)

Marking (top view)

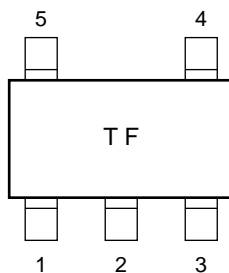

Pin Connection (top view)

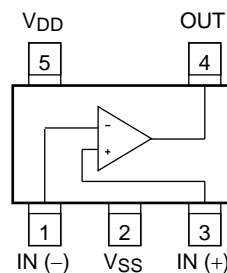

Start of commercial production
 1997-02

Absolute Maximum Ratings (Ta = 25°C)

Characteristics	Symbol	Rating	Unit
Supply voltage	V _{DD} , V _{SS}	±3.5 or 7	V
Differential input voltage	DV _{IN}	±7	V
Input voltage	V _{IN}	V _{SS} to V _{DD}	V
Output current	I _O	±35	mA
Power dissipation	P _D	200	mW
Operating temperature	T _{opr}	−40 to 85	°C
Storage temperature	T _{stg}	−55 to 125	°C

Note: Using continuously under heavy loads (e.g. the application of high temperature/current/voltage and the significant change in temperature, etc.) may cause this product to decrease in the reliability significantly even if the operating conditions (i.e. operating temperature/current/voltage, etc.) are within the absolute maximum ratings and the operating ranges.

Please design the appropriate reliability upon reviewing the Toshiba Semiconductor Reliability Handbook (“Handling Precautions”/“Derating Concept and Methods”) and individual reliability data (i.e. reliability test report and estimated failure rate, etc).

Note: This device's CMOS structure makes it prone to latch-up. To prevent latch-up, please take the following precautions:

- Ensure that no I/O pin's voltage level ever exceeds V_{DD} or drops below V_{SS}.
In addition, check the power-on timing.
- Do not subject the device to excessive noise.

Electrical Characteristics ($V_{DD} = 5\text{ V}$, $V_{SS} = \text{GND}$, $T_a = 25^\circ\text{C}$)

Characteristics	Symbol	Test Circuit	Test Condition	Min	Typ.	Max	Unit
Input offset voltage	V_{IO}	—	—	—	± 1	± 7	mV
Input offset current	I_{IO}	—	—	—	1	—	pA
Input bias current	I_I	—	—	—	1	—	pA
Common mode input voltage	CMV_{IN}	—	—	0	—	4.1	V
Supply current	I_{DD} (Note)	—	—	—	110	220	μA
Voltage gain	G_V	—	—	—	94	—	dB
Sink current	I_{sink}	—	$V_{OL} = 0.5\text{ V}$	13	25	—	mA
Output leak current	I_{LEAK}	—	$V_O = 5\text{ V}$	—	5	—	nA
Output voltage	V_{OL}	—	$I_{sink} = 5.0\text{ mA}$	—	0.1	0.3	V
Operating supply voltage	V_{DD}	—	—	1.8	—	7.0	V
Propagation delay time (turn on)	t_{PLH} (1)	—	Over drive = 100 mV	—	200	—	ns
	t_{PLH} (2)	—	TTL step input	—	140	—	
Propagation delay time (turn off)	t_{PHL} (1)	—	Over drive = 100 mV	—	80	—	ns
	t_{PHL} (2)	—	TTL step input	—	60	—	
Response time	t_{TLH}	—	Over drive = 100 mV	—	160	—	ns
	t_{THL}	—	Over drive = 100 mV	—	3	—	

Electrical Characteristics ($V_{DD} = 3\text{ V}$, $V_{SS} = \text{GND}$, $T_a = 25^\circ\text{C}$)

Characteristics	Symbol	Test Circuit	Test Condition	Min	Typ.	Max	Unit
Input offset voltage	V_{IO}	—	—	—	± 1	± 7	mV
Input offset current	I_{IO}	—	—	—	1	—	pA
Input bias current	I_I	—	—	—	1	—	pA
Common mode input voltage	CMV_{IN}	—	—	0	—	2.1	V
Supply current	I_{DD} (Note)	—	—	—	100	200	μA
Sink current	I_{sink}	—	$V_{OL} = 0.5\text{ V}$	6	18	—	mA
Output leak current	I_{LEAK}	—	$V_O = 3\text{ V}$	—	5	—	nA
Output voltage	V_{OL}	—	$I_{sink} = 5.0\text{ mA}$	—	0.15	0.35	V
Propagation delay time (turn on)	t_{PLH}	—	Over drive = 100 mV	—	160	—	ns
Propagation delay time (turn off)	t_{PHL}	—	Over drive = 100 mV	—	70	—	ns
Response time	t_{TLH}	—	Over drive = 100 mV	—	170	—	ns
	t_{THL}	—	Over drive = 100 mV	—	3	—	

Note: This device's current consumption increases as its operating frequency increases. Note that the power dissipation should not exceed the allowable power dissipation.

$I_{DD} - f$

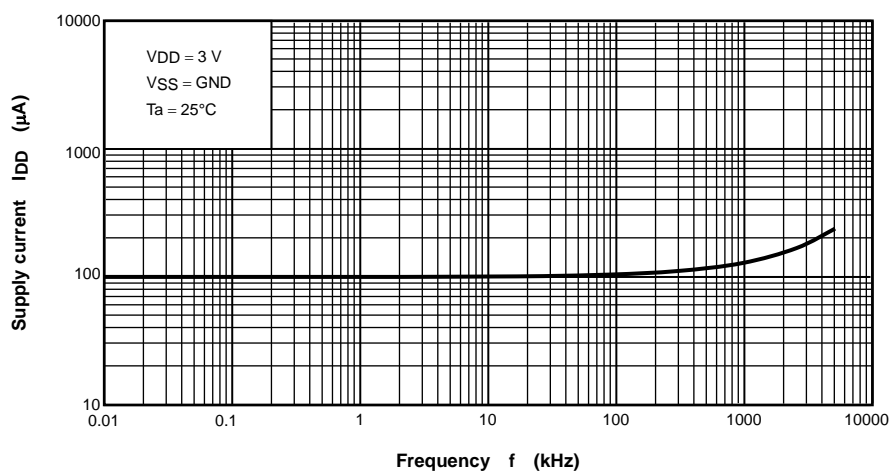

$I_{DD} - f$

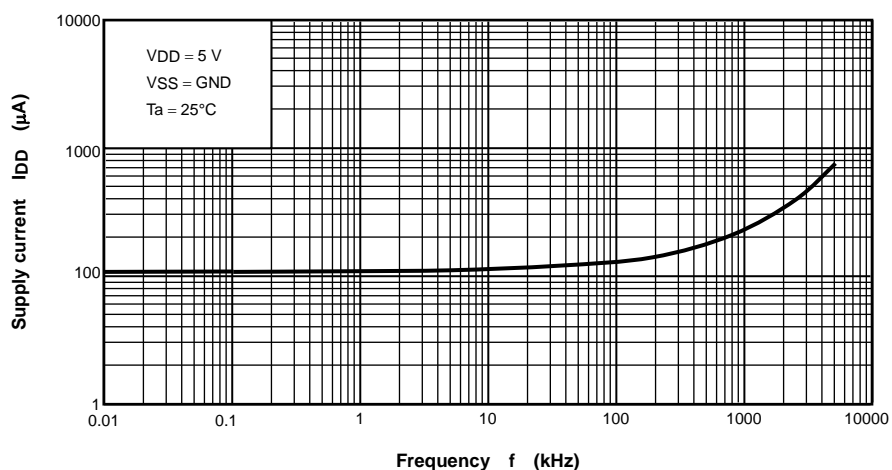

The above characteristics curves are presented for reference only and not guaranteed by production test, unless otherwise noted.

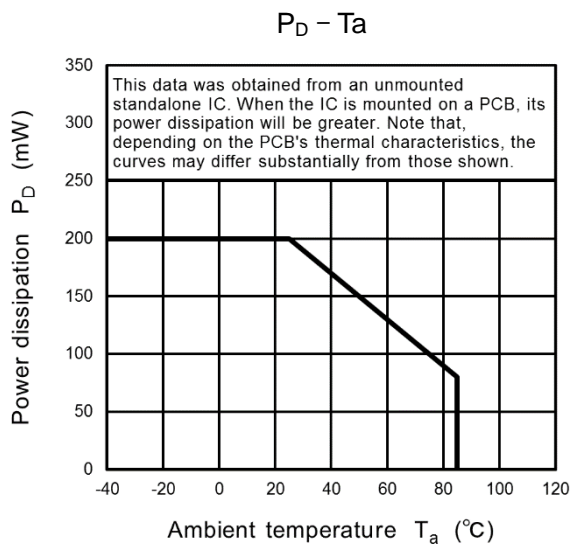
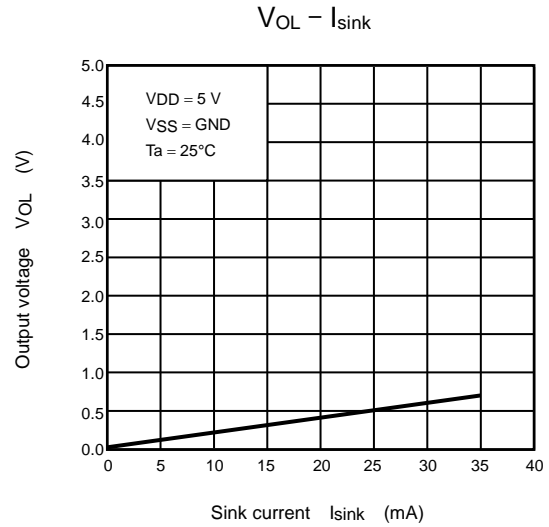
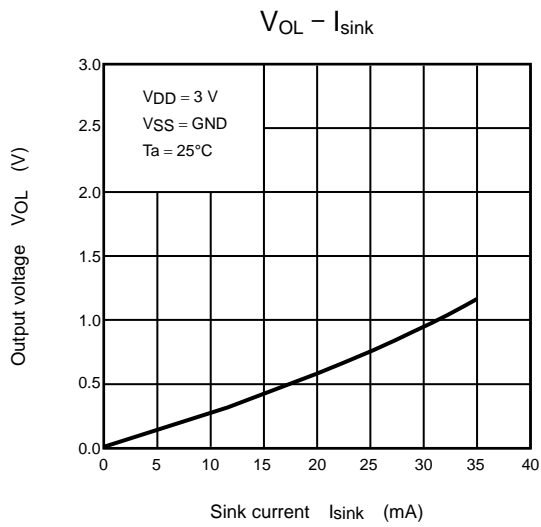

The above characteristics curves are presented for reference only and not guaranteed by production test, unless otherwise noted.

Package Dimensions

SSOP5-P-0.95

Unit : mm

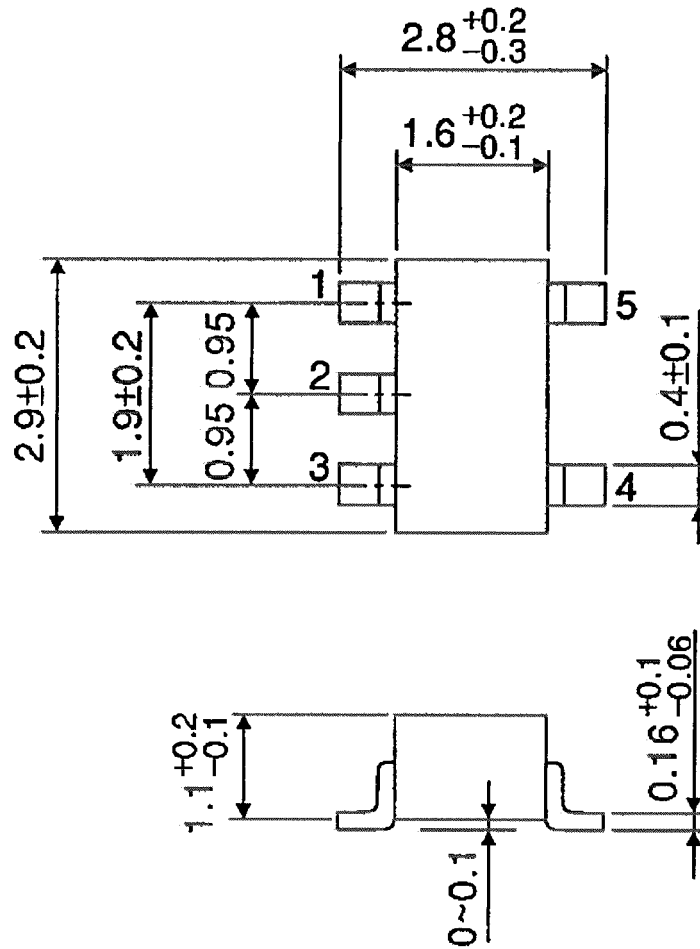

Weight: 0.014 g (typ.)

Package Dimensions

SSOP5-P-0.65A

Unit : mm

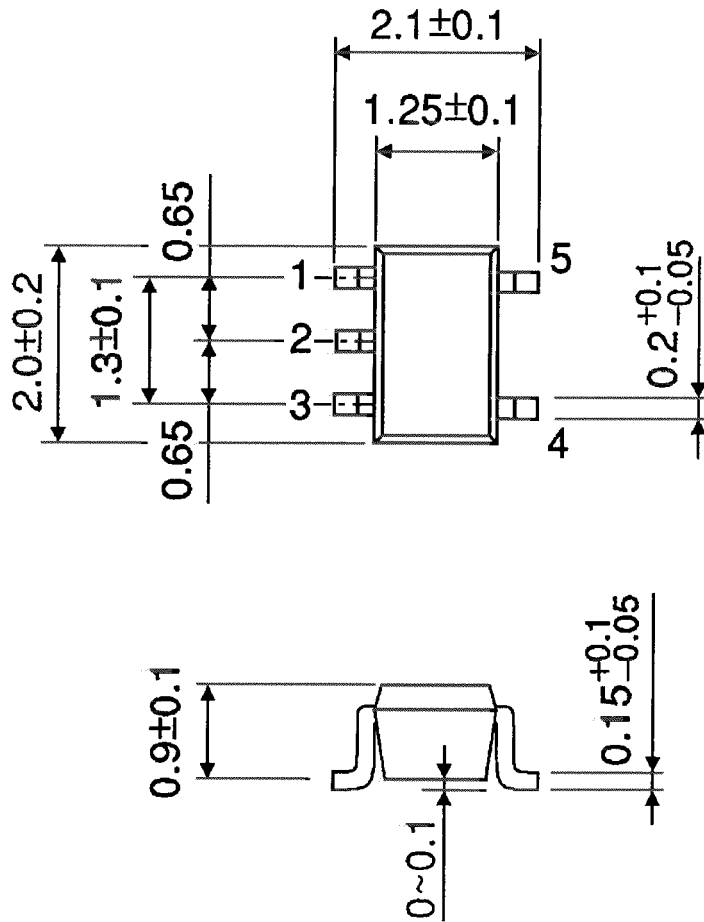

Weight: 0.006 g (typ.)

RESTRICTIONS ON PRODUCT USE

Toshiba Corporation and its subsidiaries and affiliates are collectively referred to as "TOSHIBA". Hardware, software and systems described in this document are collectively referred to as "Product".

- TOSHIBA reserves the right to make changes to the information in this document and related Product without notice.
- This document and any information herein may not be reproduced without prior written permission from TOSHIBA. Even with TOSHIBA's written permission, reproduction is permissible only if reproduction is without alteration/omission.
- Though TOSHIBA works continually to improve Product's quality and reliability, Product can malfunction or fail. Customers are responsible for complying with safety standards and for providing adequate designs and safeguards for their hardware, software and systems which minimize risk and avoid situations in which a malfunction or failure of Product could cause loss of human life, bodily injury or damage to property, including data loss or corruption. Before customers use the Product, create designs including the Product, or incorporate the Product into their own applications, customers must also refer to and comply with (a) the latest versions of all relevant TOSHIBA information, including without limitation, this document, the specifications, the data sheets and application notes for Product and the precautions and conditions set forth in the "TOSHIBA Semiconductor Reliability Handbook" and (b) the instructions for the application with which the Product will be used with or for. Customers are solely responsible for all aspects of their own product design or applications, including but not limited to (a) determining the appropriateness of the use of this Product in such design or applications; (b) evaluating and determining the applicability of any information contained in this document, or in charts, diagrams, programs, algorithms, sample application circuits, or any other referenced documents; and (c) validating all operating parameters for such designs and applications. **TOSHIBA ASSUMES NO LIABILITY FOR CUSTOMERS' PRODUCT DESIGN OR APPLICATIONS.**
- **PRODUCT IS NEITHER INTENDED NOR WARRANTED FOR USE IN EQUIPMENTS OR SYSTEMS THAT REQUIRE EXTRAORDINARILY HIGH LEVELS OF QUALITY AND/OR RELIABILITY, AND/OR A MALFUNCTION OR FAILURE OF WHICH MAY CAUSE LOSS OF HUMAN LIFE, BODILY INJURY, SERIOUS PROPERTY DAMAGE AND/OR SERIOUS PUBLIC IMPACT ("UNINTENDED USE").** Except for specific applications as expressly stated in this document, Unintended Use includes, without limitation, equipment used in nuclear facilities, equipment used in the aerospace industry, lifesaving and/or life supporting medical equipment, equipment used for automobiles, trains, ships and other transportation, traffic signaling equipment, equipment used to control combustions or explosions, safety devices, elevators and escalators, and devices related to power plant. **IF YOU USE PRODUCT FOR UNINTENDED USE, TOSHIBA ASSUMES NO LIABILITY FOR PRODUCT.** For details, please contact your TOSHIBA sales representative or contact us via our website.
- Do not disassemble, analyze, reverse-engineer, alter, modify, translate or copy Product, whether in whole or in part.
- Product shall not be used for or incorporated into any products or systems whose manufacture, use, or sale is prohibited under any applicable laws or regulations.
- The information contained herein is presented only as guidance for Product use. No responsibility is assumed by TOSHIBA for any infringement of patents or any other intellectual property rights of third parties that may result from the use of Product. No license to any intellectual property right is granted by this document, whether express or implied, by estoppel or otherwise.
- **ABSENT A WRITTEN SIGNED AGREEMENT, EXCEPT AS PROVIDED IN THE RELEVANT TERMS AND CONDITIONS OF SALE FOR PRODUCT, AND TO THE MAXIMUM EXTENT ALLOWABLE BY LAW, TOSHIBA (1) ASSUMES NO LIABILITY WHATSOEVER, INCLUDING WITHOUT LIMITATION, INDIRECT, CONSEQUENTIAL, SPECIAL, OR INCIDENTAL DAMAGES OR LOSS, INCLUDING WITHOUT LIMITATION, LOSS OF PROFITS, LOSS OF OPPORTUNITIES, BUSINESS INTERRUPTION AND LOSS OF DATA, AND (2) DISCLAIMS ANY AND ALL EXPRESS OR IMPLIED WARRANTIES AND CONDITIONS RELATED TO SALE, USE OF PRODUCT, OR INFORMATION, INCLUDING WARRANTIES OR CONDITIONS OF MERCHANTABILITY, FITNESS FOR A PARTICULAR PURPOSE, ACCURACY OF INFORMATION, OR NONINFRINGEMENT.**
- Do not use or otherwise make available Product or related software or technology for any military purposes, including without limitation, for the design, development, use, stockpiling or manufacturing of nuclear, chemical, or biological weapons or missile technology products (mass destruction weapons). Product and related software and technology may be controlled under the applicable export laws and regulations including, without limitation, the Japanese Foreign Exchange and Foreign Trade Law and the U.S. Export Administration Regulations. Export and re-export of Product or related software or technology are strictly prohibited except in compliance with all applicable export laws and regulations.
- Please contact your TOSHIBA sales representative for details as to environmental matters such as the RoHS compatibility of Product. Please use Product in compliance with all applicable laws and regulations that regulate the inclusion or use of controlled substances, including without limitation, the EU RoHS Directive. **TOSHIBA ASSUMES NO LIABILITY FOR DAMAGES OR LOSSES OCCURRING AS A RESULT OF NONCOMPLIANCE WITH APPLICABLE LAWS AND REGULATIONS.**

X-ON Electronics

Largest Supplier of Electrical and Electronic Components

Click to view similar products for [Analog Comparators](#) category:

Click to view products by [Toshiba](#) manufacturer:

Other Similar products are found below :

[SC2903VDR2G](#) [LM2901SNG](#) [LM339SNG](#) [55122](#) [5962-8757203IA](#) [NTE911](#) [5962-8751601DA](#) [LM339EDR2G](#) [NTE922](#) [SC2901DR2G](#)
[LM2903M/TR](#) [LM2903F-E2](#) [MCP6544-EP](#) [LM2901EDR2G](#) [TS391SN2T1G](#) [LM111JG](#) [LM239APT](#) [HMC675LC3CTR](#) [5962-8765801PA](#)
[MAX9024AUD+](#) [LT6700HVIS6-2#TRMPBF](#) [5962-8765902CA](#) [ADCMP394ARZ-RL7](#) [LM339AMX](#) [LTC1440IMS8#PBF](#) [AZV331KSTR-](#)
[G1](#) [LTC1841IS8#PBF](#) [LTC1440CN8#PBF](#) [LTC1542CS8#PBF](#) [LTC1445CS#PBF](#) [TL331VSN4T3G](#) [LT6700IDCB-1#TRMPBF](#)
[LTC1042CN8#PBF](#) [LTC1540CMS8#PBF](#) [LT6703CDC-2#TRMPBF](#) [ADCMP607BCPZ-R7](#) [LT1720CDD#PBF](#) [LTC1040CN#PBF](#)
[LT6700MPDCB-1#TRMPBF](#) [LT6700IDCB-3#TRMPBF](#) [LTC1440IS8#PBF](#) [S-89431ACNC-HBVTFG](#) [CMP402GSZ-REEL](#) [NTE1718](#)
[NTE943](#) [NTE943M](#) [NTE943SM](#) [TA75S393F,LF\(T](#) [ALD2301APAL](#) [ALD2302APAL](#)