

TOSHIBA CMOS LINEAR INTEGRATED CIRCUIT SILICON MONOLITHIC

# TC75W54FU, TC75W54FK

## DUAL OPERATIONAL AMPLIFIER

TC75W54 is a CMOS operational amplifier with low supply voltage, low supply current.

### FEATURES

- Low supply voltage :  $V_{DD} = \pm 0.9 \sim 3.5V$  or  $1.8 \sim 7V$
- Low supply current :  $I_{DD} (V_{DD} = 3V) = 200\mu A$  (Typ.)
- The internally phase compensated operational amplifier.
- Small package

### MAXIMUM RATINGS (Ta = 25°C)

CHARACTERISTIC	SYMBOL	RATING	N
Supply Voltage	$V_{DD}, V_{SS}$	7	V
Differential Input Voltage	$DV_{IN}$	$\pm 7$	V
Input Voltage	$V_{IN}$	$V_{DD} \sim V_{SS}$	V
Power Dissipation	$P_D$	250 (SM8)	mW
		200 (US8)	
Operating Temperature	$T_{opr}$	$-40 \sim 85$	°C
Storage Temperature	$T_{stg}$	$-55 \sim 125$	°C

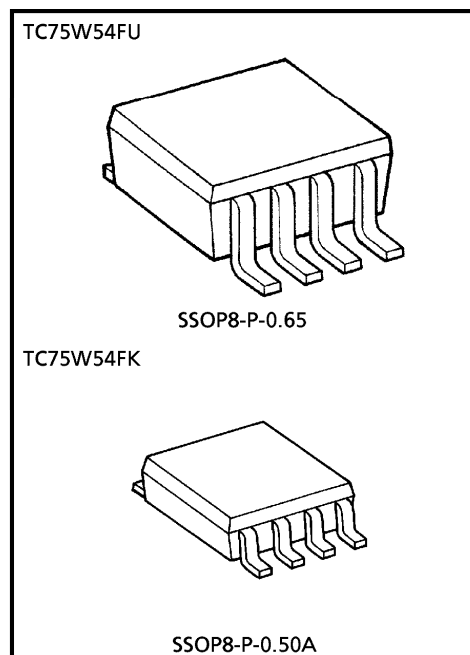

Weight  
 SSOP8-P-0.65 : 0.021g (Typ.)  
 SSOP8-P-0.50A : 0.01g (Typ.)

### MARKING (TOP VIEW)

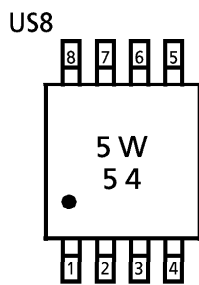
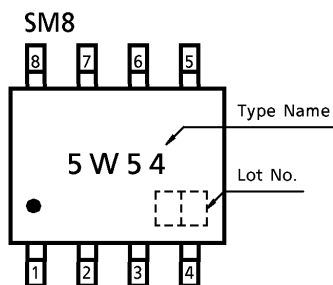

### PIN CONNECTION (TOP VIEW)

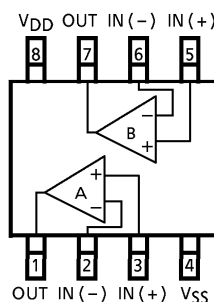

980508EBA1

- TOSHIBA is continually working to improve the quality and the reliability of its products. Nevertheless, semiconductor devices in general can malfunction or fail due to their inherent electrical sensitivity and vulnerability to physical stress. It is the responsibility of the buyer, when utilizing TOSHIBA products, to observe standards of safety, and to avoid situations in which a malfunction or failure of a TOSHIBA product could cause loss of human life, bodily injury or damage to property. In developing your designs, please ensure that TOSHIBA products are used within specified operating ranges as set forth in the most recent products specifications. Also, please keep in mind the precautions and conditions set forth in the TOSHIBA Semiconductor Reliability Handbook.
- The products described in this document are subject to foreign exchange and foreign trade laws.
- The information contained herein is presented only as a guide for the applications of our products. No responsibility is assumed by TOSHIBA CORPORATION for any infringements of intellectual property or other rights of the third parties which may result from its use. No license is granted by implication or otherwise under any intellectual property or other rights of TOSHIBA CORPORATION or others.
- The information contained herein is subject to change without notice.

**ELECTRICAL CHARACTERISTICS**

DC CHARACTERISTICS ( $V_{DD} = 3.0V$ ,  $V_{SS} = GND$ ,  $T_a = 25^\circ C$ )

CHARACTERISTIC	SYMBOL	TEST CIR-CUIT	TEST CONDITION	MIN.	TYP.	MAX.	UNIT
Input Offset Voltage	$V_{IO}$	1	$R_S = 1k\Omega$	—	2	10	mV
Input Offset Current	$I_{IO}$	—	—	—	1	—	pA
Input Bias Current	$I_I$	—	—	—	1	—	pA
Common Mode Input Voltage	$CMV_{IN}$	2	—	0.0	—	2.1	V
Voltage Gain (Open Loop)	$G_V$	—	—	60	70	—	dB
Maximum Output Voltage	$V_{OH}$	3	$R_L \geq 100k\Omega$	2.9	—	—	V
	$V_{OL}$	4	$R_L \geq 100k\Omega$	—	—	0.1	
Common Mode Input Signal Rejection Ratio	CMRR	2	$V_{IN} = 0.0 \sim 2.1V$	60	70	—	dB
Supply Voltage Rejection Ratio	SVRR	1	$V_{DD} = 1.8 \sim 7.0V$	60	70	—	dB
Supply Current	$I_{DD}$	5	—	—	200	400	$\mu A$
Source Current	$I_{source}$	6	—	100	200	—	$\mu A$
Sink Current	$I_{sink}$	7	—	200	700	—	$\mu A$

DC CHARACTERISTICS ( $V_{DD} = 1.8V$ ,  $V_{SS} = GND$ ,  $T_a = 25^\circ C$ )

CHARACTERISTIC	SYMBOL	TEST CIR-CUIT	TEST CONDITION	MIN.	TYP.	MAX.	UNIT
Input Offset Voltage	$V_{IO}$	1	$R_S = 10k\Omega$	—	2	10	mV
Input Offset Current	$I_{IO}$	—	—	—	1	—	pA
Input Bias Current	$I_I$	—	—	—	1	—	pA
Common Mode Input Voltage	$CMV_{IN}$	2	—	0.2	—	0.9	V
Voltage Gain (Open Loop)	$G_V$	—	—	60	70	—	dB
Maximum Output Voltage	$V_{OH}$	3	$R_L \geq 100k\Omega$	1.7	—	—	V
	$V_{OL}$	4	$R_L \geq 100k\Omega$	—	—	0.1	
Supply Current	$I_{DD}$	5	—	—	160	320	$\mu A$
Source Current	$I_{source}$	6	—	80	160	—	$\mu A$
Sink Current	$I_{sink}$	7	—	200	600	—	$\mu A$

AC CHARACTERISTICS ( $V_{DD} = 3.0V$ ,  $V_{SS} = GND$ ,  $T_a = 25^\circ C$ )

CHARACTERISTIC	SYMBOL	TEST CIR-CUIT	TEST CONDITION	MIN.	TYP.	MAX.	UNIT
Slew Rate	SR	—	—	—	0.7	—	$V / \mu s$
Unity Gain Cross Frequency	$f_T$	—	—	—	0.9	—	MHz

AC CHARACTERISTICS ( $V_{DD} = 1.8V$ ,  $V_{SS} = GND$ ,  $T_a = 25^\circ C$ )

CHARACTERISTIC	SYMBOL	TEST CIR-CUIT	TEST CONDITION	MIN.	TYP.	MAX.	UNIT
Slew Rate	SR	—	—	—	0.6	—	$V / \mu s$
Unity Gain Cross Frequency	$f_T$	—	—	—	0.8	—	MHz

**TEST CIRCUIT**

1. SVRR,  $V_{IO}$

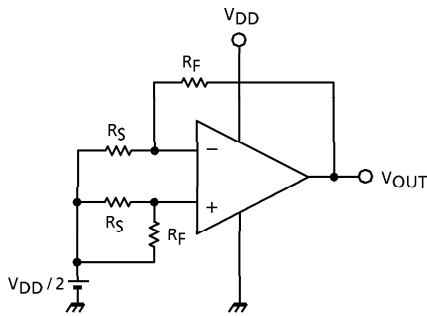

- SVRR  
 $V_{DD} = 1.8V : V_{DD} = V_{DD1}, V_{OUT} = V_{OUT1}$   
 $V_{DD} = 7.0V : V_{DD} = V_{DD2}, V_{OUT} = V_{OUT2}$   

$$SVRR = 20 \log \left( \left| \frac{V_{OUT1} - V_{OUT2}}{V_{DD1} - V_{DD2}} \right| \times \frac{R_S}{R_F + R_S} \right)$$

- $V_{IO}$   

$$V_{IO} = \left( V_{OUT} - \frac{V_{DD}}{2} \right) \times \frac{R_S}{R_F + R_S}$$

2. CMRR,  $CMV_{IN}$

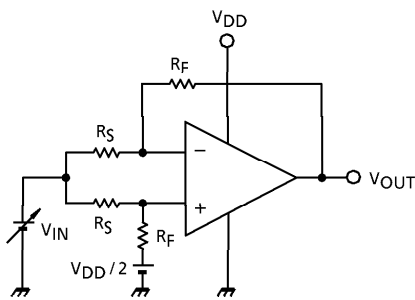

- CMRR  
 $V_{IN} = 0.0V : V_{IN} = V_{IN1}, V_{OUT} = V_{OUT1}$   
 $V_{IN} = 2.1V : V_{IN} = V_{IN2}, V_{OUT} = V_{OUT2}$   

$$CMRR = 20 \log \left( \left| \frac{V_{OUT1} - V_{OUT2}}{V_{IN1} - V_{IN2}} \right| \times \frac{R_S}{R_F + R_S} \right)$$

- $CMV_{IN}$

3.  $V_{OH}$

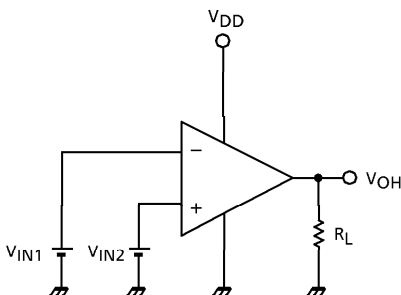

- $V_{OH}$   

$$V_{IN1} = \frac{V_{DD}}{2} - 0.05V$$
  

$$V_{IN2} = \frac{V_{DD}}{2} + 0.05V$$

4.  $V_{OL}$

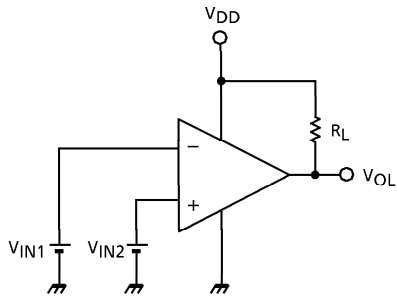

- $V_{OL}$
- $V_{IN1} = \frac{V_{DD}}{2} + 0.05V$
- $V_{IN2} = \frac{V_{DD}}{2} - 0.05V$

5.  $I_{DD}$

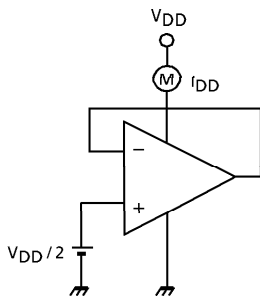

6.  $I_{source}$

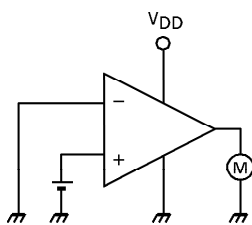

7.  $I_{sink}$

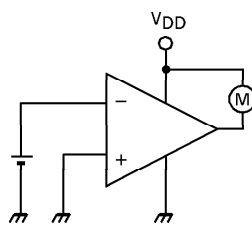

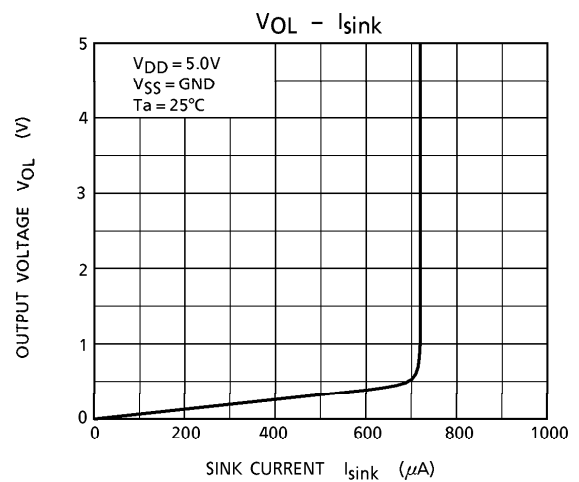
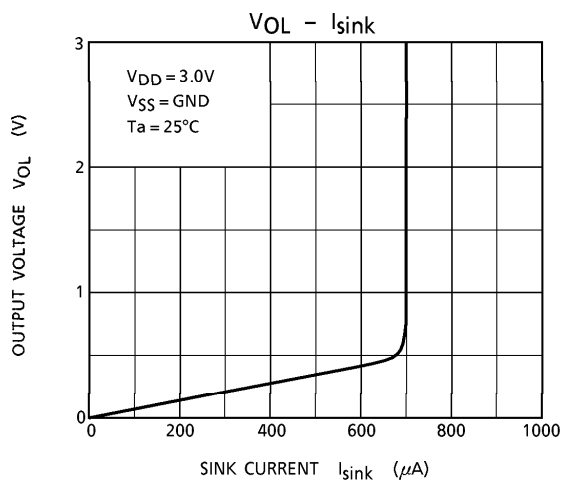
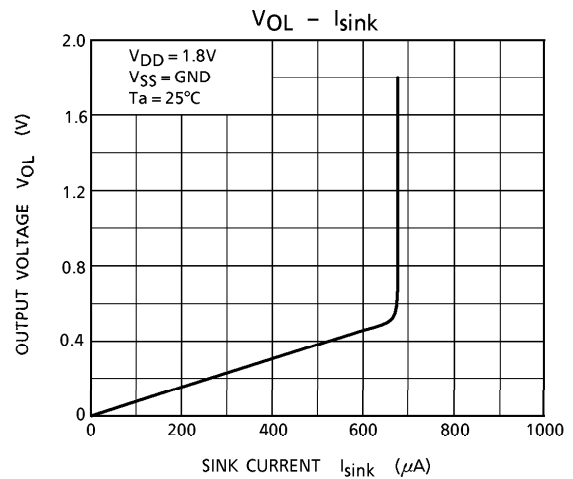
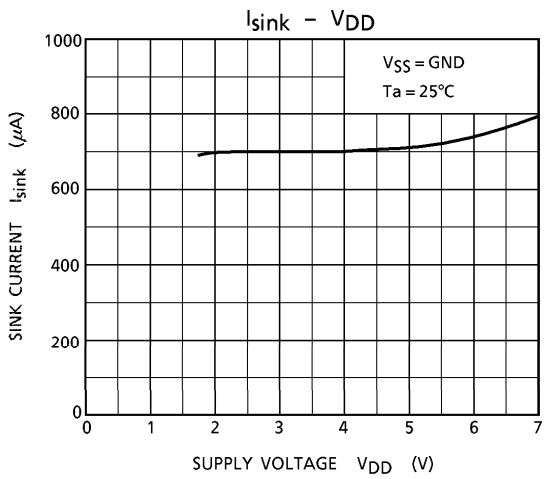
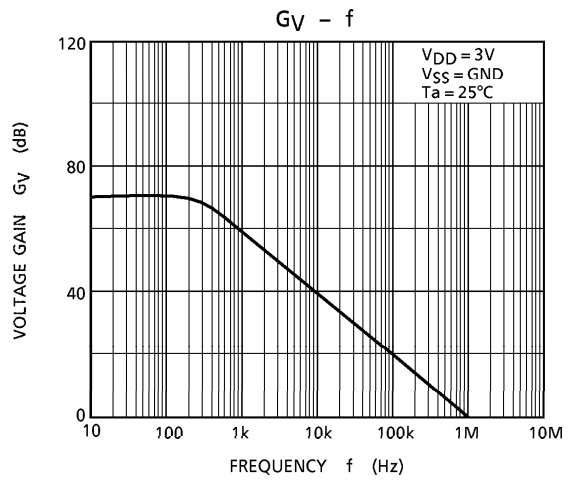
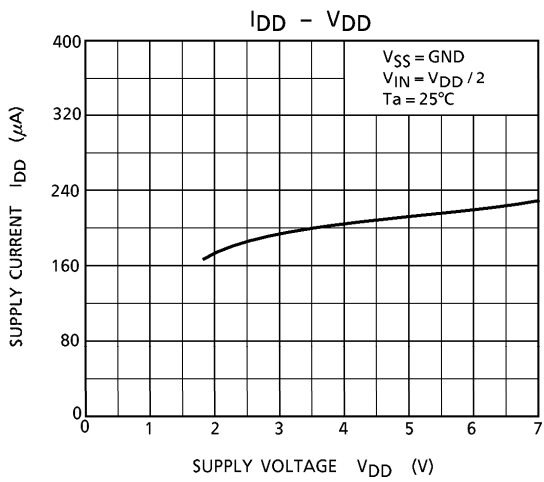

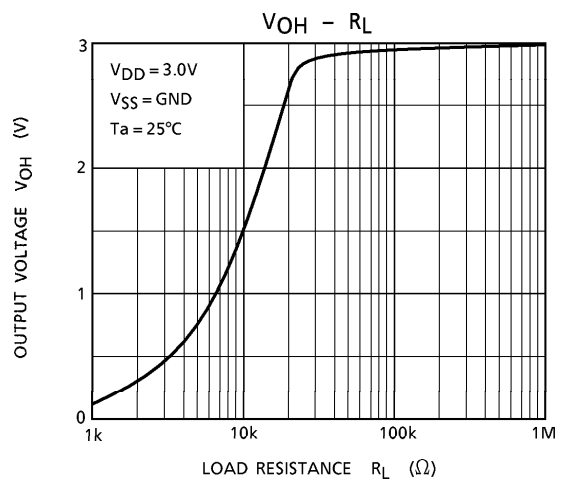
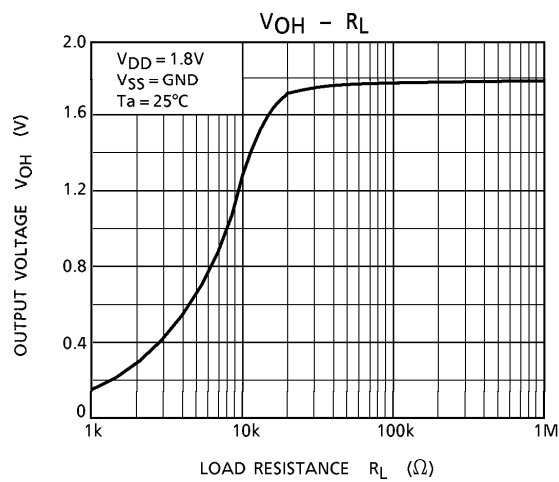
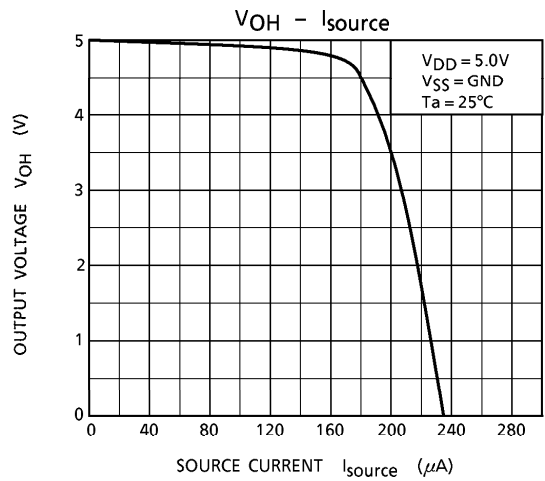
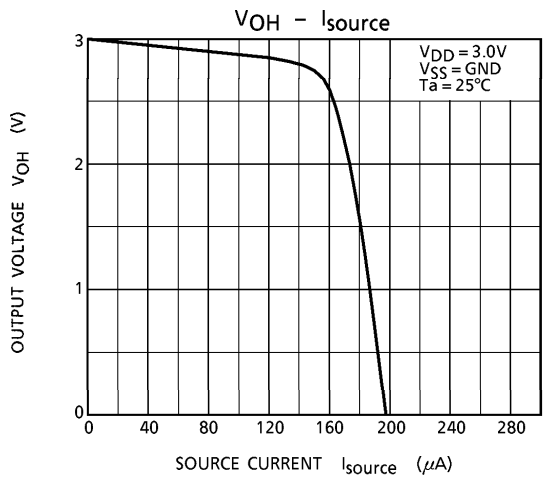
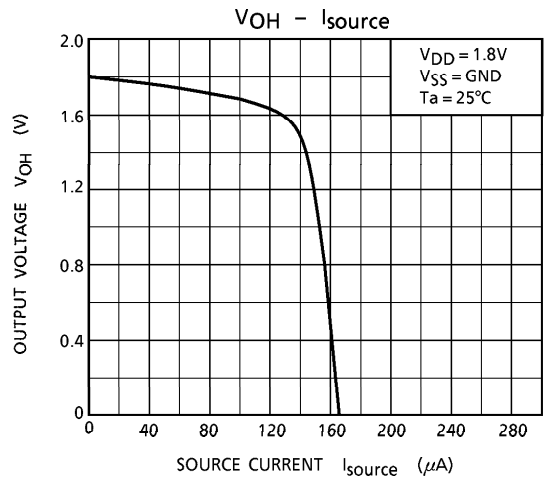
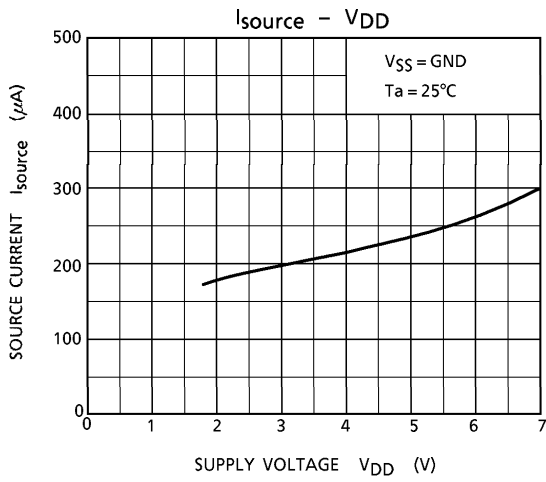

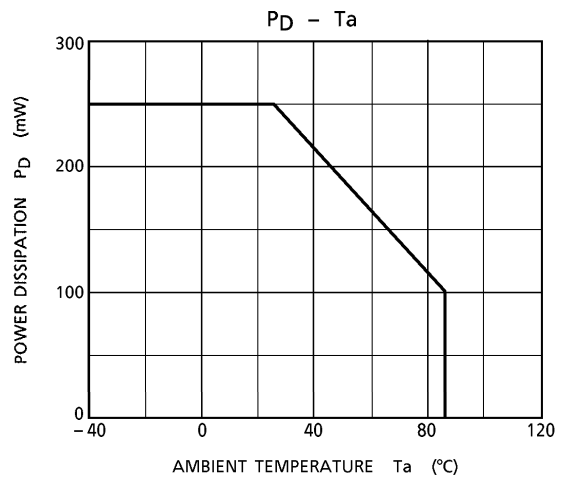
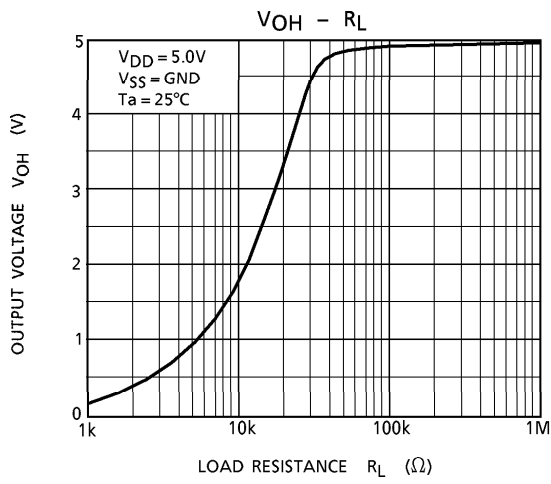

**OUTLINE DRAWING**  
SSOP8-P-0.65

Unit : mm

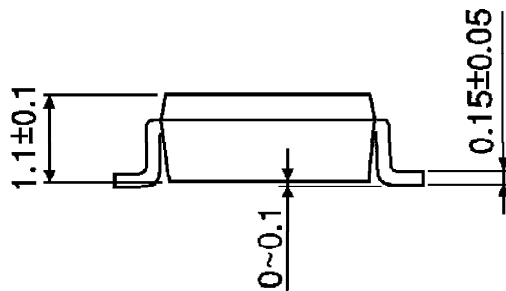
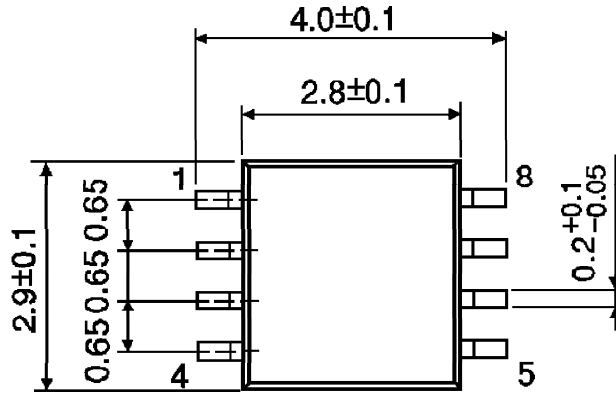

Weight : 0.021g (Typ.)



**OUTLINE DRAWING**  
SSOP8-P-0.50A

Unit : mm

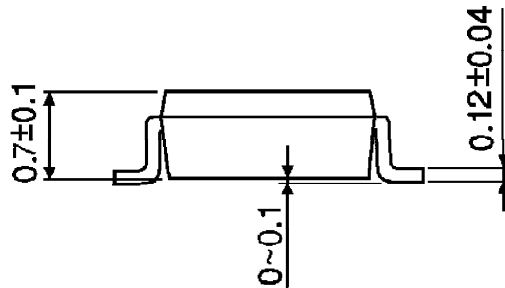
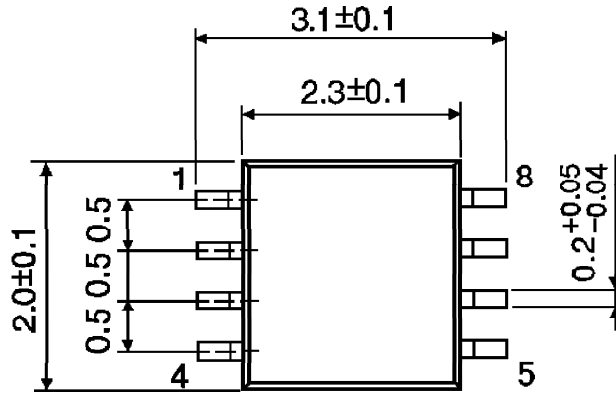

Weight : 0.01g (Typ.)

## X-ON Electronics

Largest Supplier of Electrical and Electronic Components

*Click to view similar products for [Operational Amplifiers - Op Amps](#) category:*

*Click to view products by [Toshiba](#) manufacturer:*

Other Similar products are found below :

[NCV33072ADR2G](#) [LM358SNG](#) [430227FB](#) [UPC824G2-A](#) [LT1678IS8](#) [042225DB](#) [058184EB](#) [UPC822G2-A](#) [UPC259G2-A](#) [UPC258G2-A](#)  
[NCV33202DMR2G](#) [NTE925](#) [AZV358MTR-G1](#) [AP4310AUMTR-AG1](#) [HA1630D02MMEL-E](#) [HA1630S01LPEL-E](#) [SCY33178DR2G](#)  
[NJU77806F3-TE1](#) [NCV5652MUTWG](#) [NCV20034DR2G](#) [LM324EDR2G](#) [LM2902EDR2G](#) [NTE7155](#) [NTE778S](#) [NTE871](#) [NTE924](#) [NTE937](#)  
[MCP6V17T-E/MNY](#) [MCP6V19-E/ST](#) [MXD8011HF](#) [MCP6V17T-E/MS](#) [SCY6358ADR2G](#) [ADA4523-1BCPZ](#) [LTC2065HUD#PBF](#)  
[ADA4523-1BCPZ-RL7](#) [2SD965T-R](#) [RS6332PXK](#) [BDM8551](#) [BDM321](#) [MD1324](#) [COS8052SR](#) [COS8552SR](#) [COS8554SR](#) [COS2177SR](#)  
[COS2353SR](#) [COS724TR](#) [LM2902M/TR](#) [ASOPD4580S-R](#) [RS321BKXF](#) [ADA4097-1HUIZ-RL7](#)