

TOSHIBA CDMOS Integrated Circuit Silicon Monolithic

TC78B027FTG

1-Hall sine-wave PWM pre-driver for 3-phase brushless DC motors

1. Outline

The TC78B027FTG is a 1-Hall sine-wave PWM controller for 3-phase brushless DC motors. N-ch MOSFET can be used as external FET's. A non-volatile memory (NVM) and a closed loop speed control function are incorporated. Cost can be suppressed without using microcontrollers.

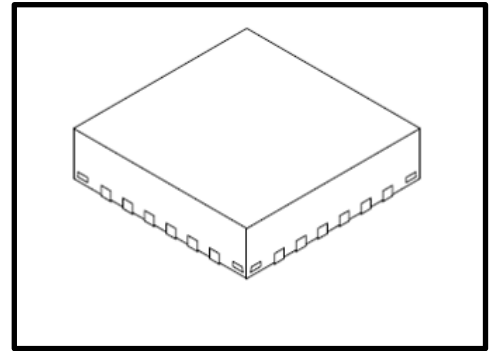

QFN24

2. Applications

Fan motors (e.g. Server)

3. Features

- 1-Hall sine-wave PWM drive
- Pre-driver for external N-ch MOSFET.
- Closed loop speed control, configurable speed curve
- Adjustable driving current for the gate of external MOSFET.
- Operating voltage range : 5 to 16V (Electrical characteristics are not guaranteed from 5 to 9V)
- Serial interface
- Standby mode
- Soft start
- Output RPM information
- Protection features:
Thermal ShutDown (TSD)、 Under Voltage LockOut (UVLO)、 Over Voltage Protection (OVP)、
Under voltage protection for the charge pump、 Over Current limit Protection (OCP)、 Over
current protection (ISD)、 Lock detection

Start of commercial production
2019-08

Contents

1. Outline.....	1
2. Applications.....	1
3. Features.....	1
4. Block Diagram.....	4
5. Absolute Maximum Ratings (Ta = 25°C).....	5
6. Operating range.....	6
7. Pin Assignment (Top view).....	6
8. Pin Description.....	7
9. I/O Equivalent Circuit.....	8
10. Electrical Characteristics.....	11
11. Functional Description.....	14
11.1. Basic Operation.....	14
11.1.1. The IC status in each mode.....	15
11.1.2. 1-Hall commutation.....	15
11.1.3. PWM frequency.....	16
11.1.4. Lead angle control.....	17
11.1.5. Soft Start.....	18
11.1.6. Acceleration and deceleration control.....	19
11.1.7. Output current for the gate of external MOSFET.....	19
11.1.8. Limitation of step of reducing rotation speed.....	20
11.2. Input / Output Signals.....	21
11.2.1. SPD.....	21
11.2.2. DIR.....	21
11.2.3. ALERT.....	22
11.2.4. HP, HM.....	23
11.2.5. FG.....	25
11.2.6. BRAKE.....	26
11.3. Speed Control.....	27
11.3.1. Closed loop.....	27
11.3.2. Open loop.....	30
11.4. Serial I/F and NVM.....	33
11.4.1. Serial commands.....	33
11.4.2. Status register.....	34
11.4.3. Normal register.....	35
11.4.4. Flowchart of writing Non-Volatile Memory (NVM).....	37
11.5. Protection Function.....	38
11.5.1. Fault and detection table.....	38
11.5.2. Lock detection.....	38

11.5.3. Output current limit protection (OCP).....	39
11.5.4. Over current protection (ISD).....	40
11.5.5. Over voltage protection (OVP).....	40
11.5.6. Under voltage lockout (UVLO).....	40
11.5.7. Charge pump under voltage	40
11.5.8. Thermal shutdown (TSD).....	40
12. Reference circuit.....	41
13. Reference board layout	42
14. Package	43
14.1. Package dimension	43
15. IC Usage Considerations.....	44
15.1. Notes on handling IC.....	44
15.2. Points to remember on handling of ICs.....	44
RESTRICTIONS ON PRODUCT USE.....	45

4. Block Diagram

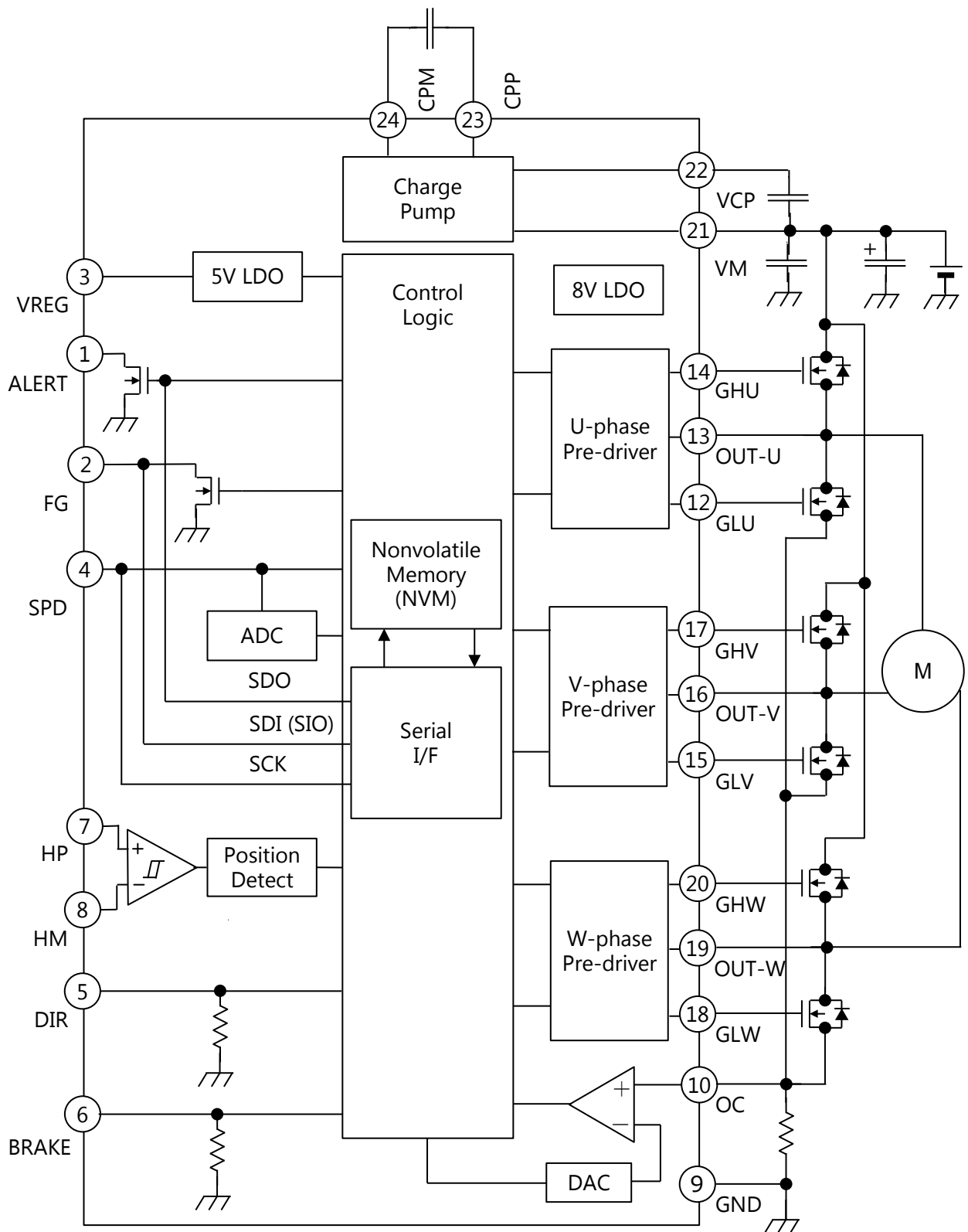

Note: Some of the functional blocks, circuits or constants may be omitted from the block diagram or simplified for explanatory purposes.

Fig 4.1 Block Diagram

5. Absolute Maximum Ratings (Ta = 25°C)

Table 5.1 Absolute Maximum Ratings

(Unless otherwise specified, Ta = 25°C)

Characteristics		Symbol	Rating	Unit
Power supply voltage of the motor		V _M	18	V
5V reference voltage		V _{REG}	6 (Note 1)	V
Charge pump voltage		V _{CP}	V _M +10 (Note 1)	V
Input voltage	HP, HM, DIR, BRAKE, OC	V _{IN}	-0.3 to 6	V
	SPD		-0.3 to 6(18) (Note2)	V
Output voltage	ALERT, FG, GLU, OUT-U, GLV, OUT-V, GLW, OUT-W,	V _{OUT}	18	V
	GHU, GHV, GHW		V _M +10	V
Output current	ALERT, FG, VREG	I _{OUT}	10	mA
	GLU, GHU, GLV, GHV, GLW, GHW FET gate source current		100	mA
	GLU, GHU, GLV, GHV, GLW, GHW FET gate sink current		200	mA
Power dissipation		P _D	1.7 (Note3)	W
Operating temperature		T _{opr}	-40 to 105	°C
Storage temperature		T _{stg}	-55 to 150	°C
Junction temperature		T _{J(MAX)}	150	°C

Note 1: V_{REG} and V_{CP} pin voltage are generated in the IC. Do not apply voltage externally.

Note 2: This terminal should be used within operating range. However up to 18V can be applied, it does NOT mention that IC will not deteriorate in such a case.

Note 3: When mounted on a board, (JEDEC 2-layer board, R_{θja}=73.5°C/W)

Note: Output current is limited depend on the ambient temperature and the device implementation. The maximum junction temperature (T_{J(MAX)}) should not exceed 150°C.

Note: The absolute maximum ratings of a semiconductor device are a set of ratings that must not be exceeded, even for a moment. Do not exceed any of these ratings. Exceeding the ratings may cause the device breakdown, damage or deterioration, and may result injury by explosion or combustion. Please use the IC within the specified operating ranges.

6. Operating range

Table 6.1 Operating range (Unless otherwise specified, Ta=-40 to 105°C)

Characteristics		Symbol	Min.	Typ.	Max.	Unit
VM pin power supply voltage1		$V_{M(opr1)}$	9	12	16	V
VM pin power supply voltage2 (Note1)		$V_{M(opr2)}$	5.0	—	9	V
VM pin power supply voltage3 (Note2)		$V_{M(opr3)}$	10.8	12	16	V
Input PWM frequency		f_{TSP}	1	—	100	kHz
Input SPI CLK frequency		f_{SCK}	15	—	500	kHz
Input voltage	HP, HM	V_{IN}	0.1	—	$V_{REG} - 2.0$	V
	DIR, SPD, BRAKE, OC		-0.3	—	5.5	V

Note 1: Electrical characteristics are only for reference because the variation of electrical characteristics becomes large.

Note 2: For NVM writing.

Table 6.2 NVM Characteristics

Characteristics	Conditions	Min.	Max.	Unit
Program/Erase cycle	$T_j = 0$ to 90 °C	10	—	Cycle

7. Pin Assignment (Top view)

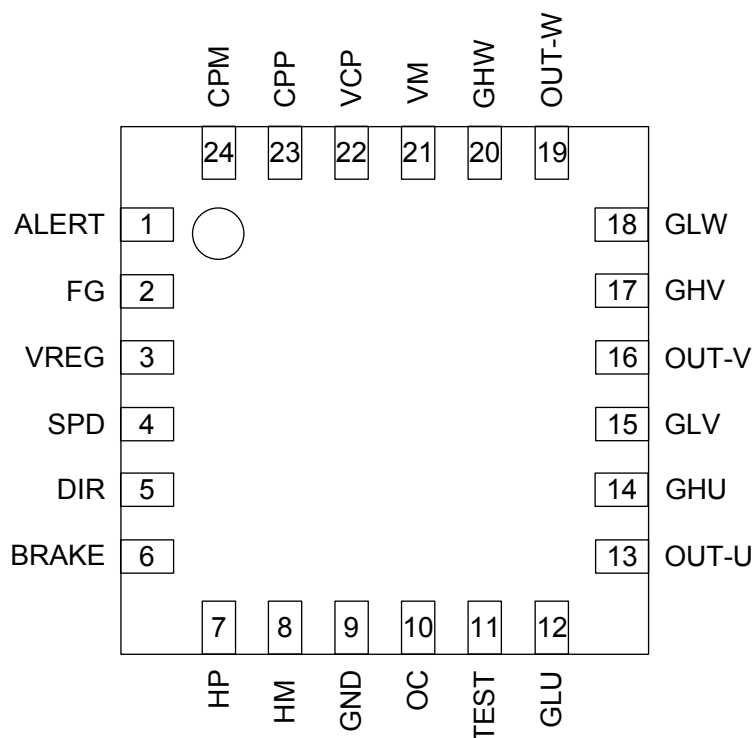

Figure 7.1 Pin assignment (Top view)

8. Pin Description

Table 8.1 Pin description

Pin No.	Pin Name	Input / Output	Description
1	ALERT	OUT	Output pin for alert signal, serial I/F data output pin
2	FG	IO	Output pin for rotation number signal, serial I/F data I/O pin
3	VREG	—	5V reference voltage output pin
4	SPD (Note1)	IN	Input pin for speed command, serial I/F clock input pin
5	DIR	IN	Input pin for rotation direction signal (50 kΩ pull-down)
6	BRAKE	IN	Input pin for brake command (50kΩ pull-down)
7	HP	IN	Hall signal input (+) pin
8	HM	IN	Hall signal input (-) pin
9	GND	—	GND pin
10	OC	IN	Input pin for the current sense resistor.
11	TEST (Note 2)	—	TEST pin
12	GLU	OUT	U-phase low-side MOSFET gate driver output.
13	OUT-U	IN	Input pin for U-phase signal of the motor
14	GHU	OUT	U-phase high-side MOSFET gate driver output.
15	GLV	OUT	V-phase low-side MOSFET gate driver output.
16	OUT-V	IN	Input pin for V-phase signal of the motor
17	GHV	OUT	V-phase high-side MOSFET gate driver output.
18	GLW	OUT	W-phase low-side MOSFET gate driver output.
19	OUT-W	IN	Input pin for W-phase signal of the motor
20	GHW	OUT	W-phase high-side MOSFET gate driver output.
21	VM	—	Power supply pin
22	VCP	—	Connect pin for accumulation capacitor of charge pump
23	CPP	—	Connect pin for pumping capacitor of charge pump
24	CPM	—	Connect pin for pumping capacitor of charge pump

Note1: SPD pin should not be left open state.

Note2: TEST pin must be connected to GND.

9. I/O Equivalent Circuit

Pin Name	Description	Equivalent Circuit
ALERT	Output pin for alert signal Open drain Serial I/F data output pin	
FG	Output pin for rotation number signal Open drain Serial I/F data I/O pin	
VREG	5V reference voltage output pin	
HP HM	Hall signal input pin	
SPD	Input pin for speed command Serial I/F clock input pin	
DIR	Input pin for rotation direction signal 50 kΩ pull-down	
BRAKE	Input pin for brake command 50kΩ pull-down	

Pin Name	Description	Equivalent Circuit
OC	Input pin for the current sense resistor	
TEST	TEST pin 50kΩ pull-down	
GHU GHV GHW OUT-U OUT-V OUT-W	GHx: High-side MOSFET gate driver output. OUT-x: Input pin for the motor	
GLU GLV GLW	Low-side MOSFET gate driver output.	

Pin Name	Description	Equivalent Circuit
<p>VCP CPP CPM</p>	<p>Pins for the charge pump</p>	

10. Electrical Characteristics

Table 10.1 Electrical characteristics (Unless otherwise specified, $V_M = 12V$, $T_a = 25^\circ C$)

Characteristics		Symbol	Conditions	Min.	Typ.	Max.	Unit
Power supply current		I_{VM}	$V_M = 12V$, $V_{REG} = OPEN$ Hall signal input = 100 Hz, Output = OPEN	—	10	12.5	mA
		I_{STBY}	$V_M = 12V$, Standby mode	—	0.33	0.5	mA
VREG pin voltage		V_{REG}	$V_M = 12V$, $I_{VREG} = 0$ to 10mA	4.5	5.0	5.5	V
Charge pump voltage		V_{CP}	$V_M - V_{CP} : 0.1\mu F$, CPP – CPM : $0.01\mu F$ $V_M = 9V$	$V_M + 7.6$	$V_M + 8.1$	$V_M + 8.6$	V
MOSFET gate signal voltage		$V_{O(H)-(H)}$	I_{OUT} of GHU, GHV, GHW = -1mA	$V_{CP} - 0.5$	—	V_{CP}	V
		$V_{O(H)-(L)}$	I_{OUT} of GHU, GHV, GHW = 1mA	—	—	0.6	V
		$V_{O(L)-(H)}$	I_{OUT} of GLU, GLV, GLW = -1mA	6.9	7.7	8.5	V
		$V_{O(L)-(L)}$	I_{OUT} of GLU, GLV, GLW = 1mA	—	—	0.6	V
Hall input signal	Common phase input voltage range	V_{HCMR}	—	0.1	—	$V_{REG} - 2.0$	V
	Input amplitude range	V_H	—	40	—	—	mV
	Input current	I_{HIN}	—	—	—	1	μA
	Hysteresis(+) voltage	V_{HHYS+}	—	—	+8	—	mV
	Hysteresis (-) voltage	V_{HHYS-}	—	—	-8	—	mV
SPD pin	Standby mode control voltage	$V_{STBY(L)}$	Standby mode switching voltage	1.00	1.15	—	V
		$V_{STBY(H)}$	Standby mode releasing voltage	—	1.25	1.40	V
		$V_{STBY(hys)}$	Hysteresis voltage	—	100	—	mV
	Input current	I_{SPD}	$V_{SPD} = 0V$ to V_{REG}	—	—	1	μA
SPD pin During PWM duty input	Input voltage	$V_{TSP(H)}$	High voltage	2.0	—	5.5	V
		$V_{TSP(L)}$	Low voltage	-0.3	—	1.0	V
		$V_{TSP(hys)}$	Hysteresis voltage	—	200	—	mV
	Input frequency	f_{TSP}	—	1	—	100	kHz
	100 % duty detection time	$T_{duty(100)}$	—	—	1.5	—	ms
	0 % duty detection time	$T_{duty(0)}$	—	—	100	—	ms
SPD pin During analog voltage input	Input voltage	$V_{VSP(H)}$	ADC = 512(100%)	3.9	4.0	4.1	V
		$V_{VSP(L)}$	ADC = 0(0%)	1.4	1.5	1.6	V
	ADC response time	t_{ADC}	—	—	—	10	ms
DIR pin	Input voltage	$V_{DIR(H)}$	High voltage	2.0	—	5.5	V
		$V_{DIR(L)}$	Low voltage	-0.3	—	1.0	V
		$V_{DIR(hys)}$	Hysteresis voltage	—	200	—	mV
	Input current	$I_{DIR(H)}$	$V_{DIR} = 5V$	80	100	120	μA
		$I_{DIR(L)}$	$V_{DIR} = 0V$	—	—	1	μA

Characteristics		Symbol	Conditions	Min.	Typ.	Max.	Unit
BRAKE	Input voltage	$V_{BRK(H)}$	High voltage	2.0	—	5.5	V
		$V_{BRK(L)}$	Low voltage	-0.3	—	1.0	V
		$V_{BRK(hys)}$	Hysteresis voltage	—	200	—	mV
	Input current	$I_{BRK(H)}$	BRAKE pin voltage = 5V	80	100	120	μ A
		$I_{BRK(L)}$	BRAKE pin voltage = 0V	—	—	1	μ A
Internal OSC frequency		f_{OSC}	—	11.64	12.00	12.36	MHz
Output PWM frequency		$f_{PWM(1)}$	$f_{OSC} = 12\text{MHz}$, PWMSEL[2:0] = 000	—	23.4	—	kHz
		$f_{PWM(2)}$	$f_{OSC} = 12\text{MHz}$, PWMSEL[2:0] = 011	—	187.5	—	kHz
FG pin	Output low voltage	$V_{OFG(L)}$	$I_{FG}=5\text{ mA}$	—	0.15	0.30	V
	Output leakage current	I_{OFGR}	$V_{FG}=18\text{ V}$	—	1.5	5.0	μ A
ALERT pin	Output low voltage	$V_{OAL(L)}$	$I_{ALERT}=5\text{ mA}$	—	0.15	0.30	V
	Output leakage current	I_{OALR}	$V_{ALERT}=18\text{ V}$	—	—	1.0	μ A
Voltage limit for the current sense resistor		V_{OC}	$V_{oc}=0.250\text{V}$	0.2	0.25	0.3	V
			$V_{oc}=0.125\text{V}$	0.1	0.125	0.15	V
Voltage limit for the over current protection		V_{ISD}	$V_{ISD} = 0.5\text{V}$	0.4	0.5	0.6	V
			$V_{ISD} = 1.0\text{V}$	0.8	1.0	1.2	V
Current for the detection of OC pin opening		$I_{OC(D)}$	$V_{OC(D)} = 0\text{V}$	—	0.1	1	μ A
Thermal shutdown	Shutdown temperature	$T_{TSD(D)}$	In rising temperature (Design value)	—	170	—	$^{\circ}\text{C}$
	Release hysteresis temperature	ΔT_{TSD}	In falling temperature (Design value)	—	40	—	$^{\circ}\text{C}$
	Release temperature	$T_{TSD(R)}$	In falling temperature (Design value)	—	130	—	$^{\circ}\text{C}$
Over voltage protection	Switching voltage (from sine-wave drive to 150 $^{\circ}$ commutation)	$V_{OV(D)}$	In V_M rising	16.5	17.2	17.9	V
	Recovery hysteresis voltage (from 150 $^{\circ}$ commutation to sine-wave drive)	ΔV_{OV}	In V_M falling	—	400	—	mV
	Recovery voltage (from 150 $^{\circ}$ commutation to sine-wave drive)	$V_{OV(R)}$	In V_M falling	16.1	16.8	17.5	V
Under voltage protection for VM	UVLO operating voltage	$V_{MUV(D)}$	In V_M falling	3.7	3.9	4.1	V
	UVLO hysteresis voltage	ΔV_{MUV}	In V_M rising	—	300	—	mV
	UVLO release voltage	$V_{MUV(R)}$	In V_M rising	4.0	4.2	4.4	V

Characteristics		Symbol	Conditions	Min.	Typ.	Max.	Unit
Under voltage protection for V_{REG}	UVLO operating voltage	$V_{RUV(D)}$	In V_{REG} falling	—	3.7	—	V
	UVLO hysteresis voltage	ΔV_{RUV}	In V_{REG} rising	—	300	—	mV
	UVLO release voltage	$V_{RUV(R)}$	In V_{REG} rising	—	4.0	—	V
Under voltage protection for charge pump	Under voltage protection operating voltage	$V_{CUV(D)}$	In the voltage between VCP pin and VM pin falling $V_M \geq 5.5V$	—	3.7	—	V
	Under voltage protection hysteresis voltage	ΔV_{CUV}	In the voltage between VCP pin and VM pin rising $V_M \geq 5.5V$	—	300	—	mV
	Under voltage protection release voltage	$V_{CUV(R)}$	In the voltage between VCP pin and VM pin rising $V_M \geq 5.5V$	—	4.0	—	V

Table 10.2 Serial I / F (Unless otherwise specified, $V_M = 12 V$ and $T_a = 25^\circ C$)

Characteristics		Symbol	Conditions	Min.	Typ.	Max.	Unit
SCK	Input voltage	$V_{SCK(H)}$	High voltage	2.0	—	5.5	V
		$V_{SCK(L)}$	Low voltage	-0.3	—	1.0	V
		$V_{SCK(hys)}$	Hysteresis voltage	—	100	—	mV
	Input frequency	f_{SCK}	—	15	—	500	kHz
	High period	t_{WH}	—	1	—	—	μs
	Low period	t_{WL}	—	1	—	—	μs
SDI(SIO)	Setup period	t_{SDIS}	—	1	—	—	μs
	Hold period	t_{SDIH}	—	500	—	—	ns
SDO(SIO)	Setup period	—	—	—	—	500	ns

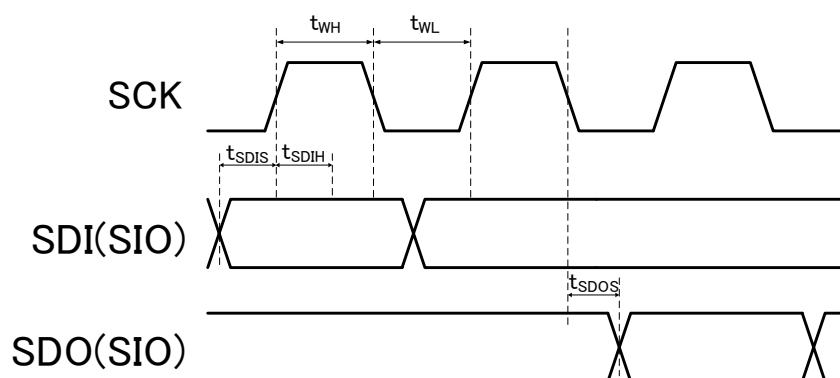

Figure 10.1 Serial I / F timing chart

11. Functional Description

11.1. Basic Operation

The TC78B027FTG can be operated by 1-Hall sine-wave commutation and 1-Hall 150° commutation. Also, a closed loop speed control function is implemented without using an external microcontroller. Motor rotation speed can be controlled by inputting PWM signal or applying analog voltage to the SPD pin.

The operation moves to the standby mode when a zero cross of the Hall signal is not detected for a lock detection period after the voltage of $V_{STBY(L)}$ or less is applied to the SPD pin. In the standby mode, the IC power consumption is reduced by powering off its internal 5-V regulator. In case that the Hall element is power supplied by the IC's 5-V regulator, the power consumption of the whole motor system can be reduced. In case that motor is configured as not stop when the voltage of SPD pin is $V_{STBY(L)}$ or less, standby mode is disabled.

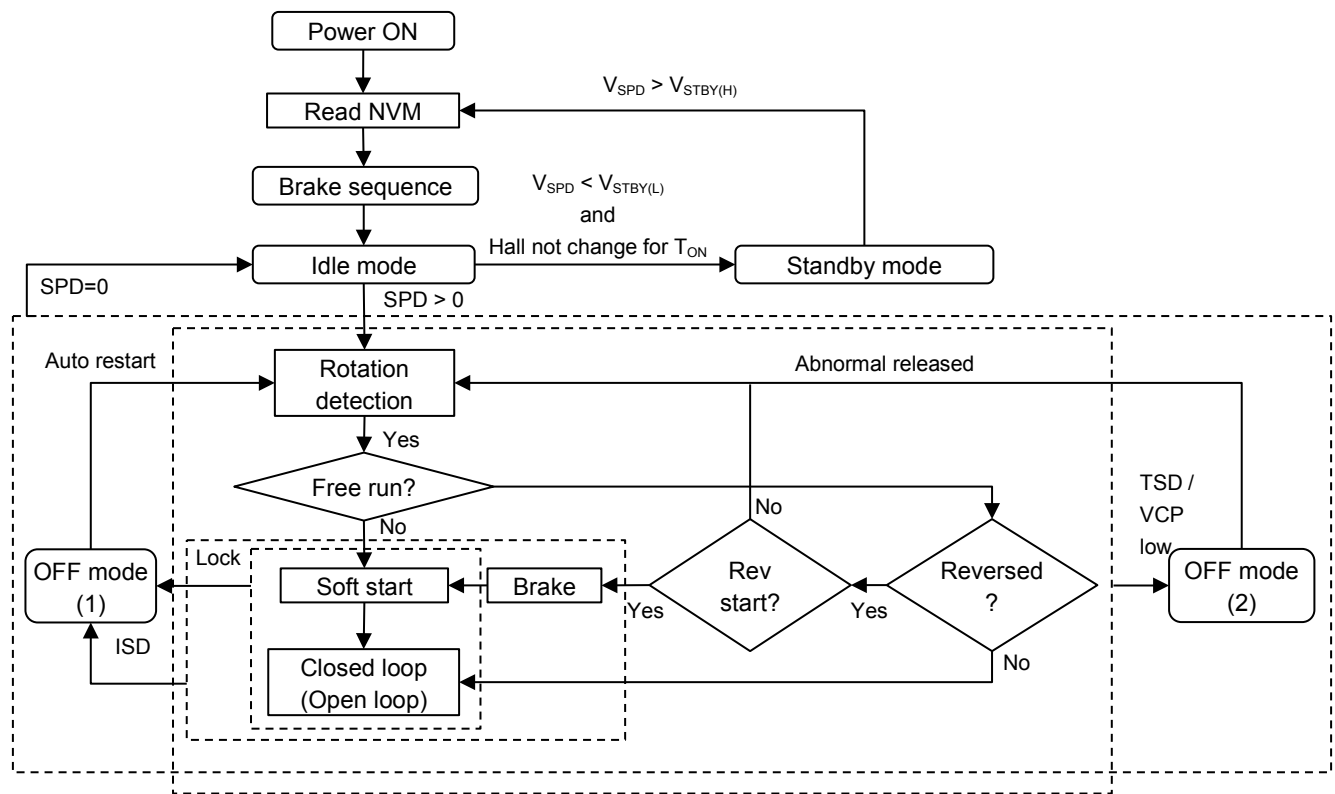

Figure 11.1 Basic operation flow chart

11.1.1. The IC status in each mode

		Read NVM	Stop mode	OFF mode (1)	OFF mode (2)	Standby mode	Normal mode
VREG		5V	5V	5V	5V	OFF	5V
Charge pump		Active	Active	Active	Active	Inactive	Active
FG function	FG	In reading : L After reading : Hi-Z	Hall output (Hi-Z under 1Hz)	Hi-Z	Hall output (Hi-Z under 1Hz)	Hi-Z	Hall output (Hi-Z under 1Hz)
	RDO		State sustaining	State sustaining	State sustaining	Hi-Z	Lock is detected : L Lock is released : Hi-Z
ALERT		Hi-Z	State sustaining (Note 1)	L(Note 3)	L(Note 3)	Hi-Z	Fault(Note 2)is detected : L(Note 3) Fault is released : Hi-Z
GLx(x:U,V,W) GHx(x:U,V,W)		L	L	L	L	Hi-Z	Active

Note 1 : ALERT=L when TSD / VCP is dropped. ALERT is released when the cause of fault is released.

Note 2 : Fault means ISD / TSD / VCP dropping and lock.

Note 3 : When ALERTINV=0. ALERT outputs H level when ALERTINV=1.

11.1.2. 1-Hall commutation

The TC78B027FTG can be operated by 1-Hall sine-wave commutation and 1-Hall 150° commutation. The way of commutation can be switched by register.

Rotation direction is defined by DIR and register setting.

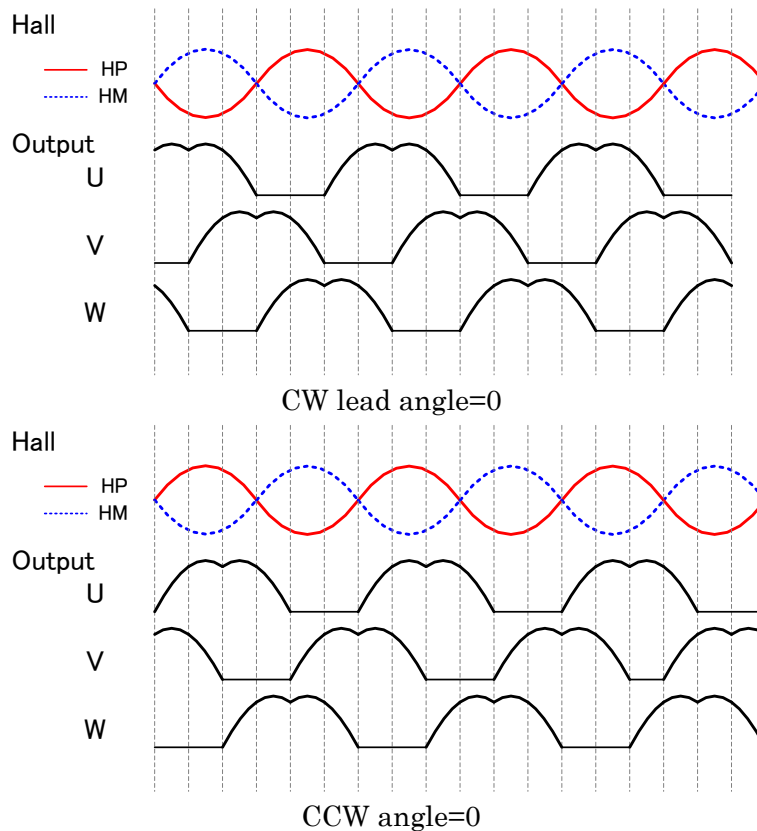

Figure 11.2 Timing chart of Hall input signal and sine-wave commutation signal

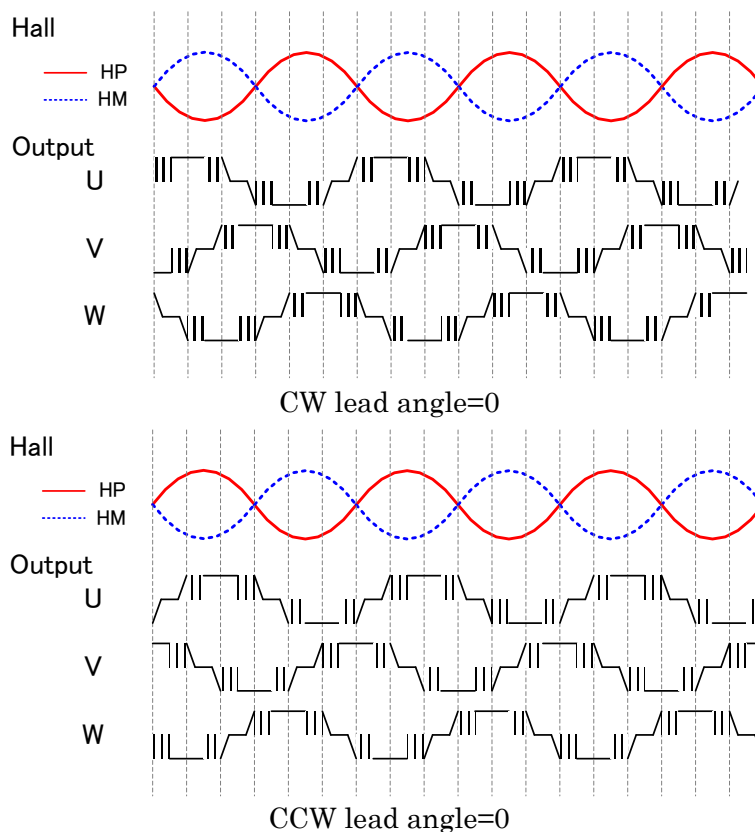

Figure 11.3 Timing chart of Hall input and 150° commutation signal

11.1.3. PWM frequency

PWM is generated from internal oscillator.

Table 11.1 Division ratio vs PWM frequency

Division ratio	PWM frequency
512	23.4kHz
256	46.9kHz
128	93.7kHz
64	187.5kHz

Table 11.2 The setting of PWM frequency

PWMSEL[2:0]			f _{hall}					
			0 to 250 150 to 0	250 to 500 400 to 150	500 to 1000 900 to 400	1000 to 1500 1400 to 900	1500 to 2000 1900 to 1400	Over 2000 Under 1900
0	0	0	23.4kHz					
0	0	1	46.9kHz					
0	1	0	93.7kHz					
0	1	1	187.5kHz					
1	0	0	23.4kHz	23.4kHz	46.9kHz	46.9kHz	93.7kHz	93.7kHz
1	0	1	23.4kHz	46.9kHz	46.9kHz	93.7kHz	93.7kHz	187.5kHz
1	1	0	23.4kHz	46.9kHz	93.7kHz	93.7kHz	187.5kHz	187.5kHz
1	1	1	46.9kHz	93.7kHz	93.7kHz	187.5kHz	187.5kHz	187.5kHz

There is a 100Hz hysteresis when the motor decreases its speed.

11.1.4. Lead angle control

TC78B027 contains the function of lead angle control.

This function requires a Hall signal to compensate the lead angle with the setting of LATABLE.

Table 11.3 Table of LATABLE

LATABLE[4:0]					The value of lead angle
0	0	0	0	0	LATABLE = 0 to 27 Lead angle(deg) = 1.875(deg) x Speed(RPM) / 4096 x LATABLE Maximum lead angle is 58.125°
.					
1	1	0	1	1	7.5° fixed
1	1	1	0	0	15° fixed
1	1	1	1	0	22.5° fixed
1	1	1	1	1	30° fixed

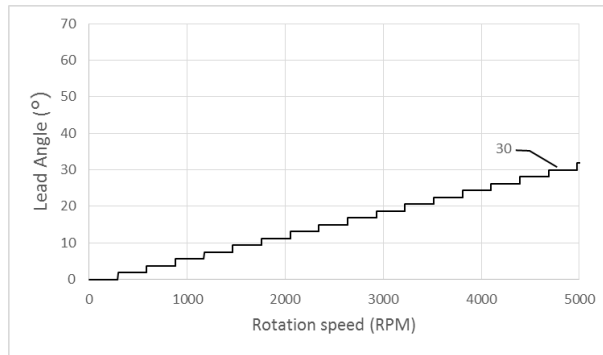

Figure 11.4 Example of the setting of lead angle LATABLE = 14 (1b01110)

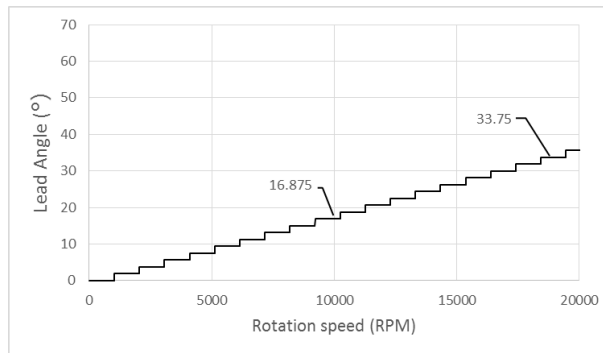

Figure 11.5 Example of the setting of lead angle LATABLE = 4 (1b00100)

This IC contains the function of automatic optimizing lead angle, InPAC, from “Zero cross of Hall signal” and “Zero cross of motor current”

Table 11.4 The setting of controlling lead angle

LASEL	Auto
0	InPAC enable
1	InPAC disable

- InPAC is enabled when LASEL=0.

Lead angle=Optimized lead angle by InPAC + lead angle set in LTABLE

Since a low motor current in low speed makes a difficulty of detecting zero cross, InPAC regards an optimized lead angle is zero when the motor speed becomes under startup frequency.

When LASEL=1, InPAC is disabled and an optimized lead angle is zero.

11.1.5. Soft Start

Soft start operates when the motor starts from the stop state to prevent rush current.

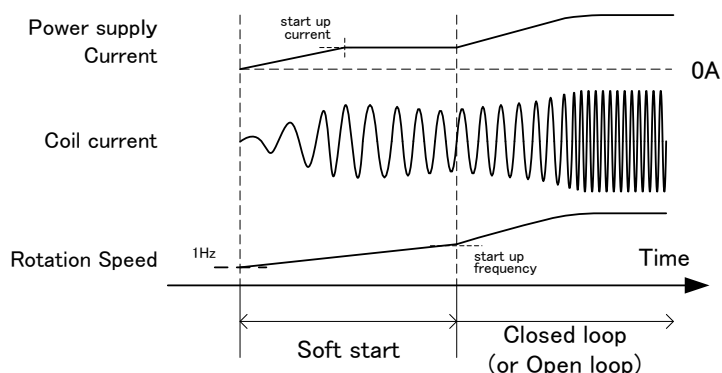

Figure 11.6 Timing chart of soft start

- Soft start increases the output duty gradually from 0 % until the output current reaches the startup current.
- The rotation frequency increases from 1 Hz. Soft start is finished and switches to the closed loop speed control or the open loop speed control when the rotation frequency reaches the switching frequency (startup frequency).
- The way of commutation is defined by register setting.

The time for lock detecting in soft start can be selected by register setting so that slow start motor can be used.

Table 11.5 The setting of the time for lock detecting in soft start

SS_LOCK	The time for lock detecting (s)
0	TON x 1
1	TON x 5

11.1.6. Acceleration and deceleration control

Acceleration and deceleration rate of motor can be controlled by limiting of PWM duty.

Table 11.6

Duty change limit (DUTYCHGLIMIT)	Variation amount of duty every 2.7ms ($\Delta/512$)	Time (sec) 0% to 100%
0	N/A (64/8)	0.17
1	2/8	5.53
2 (default)	3/8	3.69
3	4/8	2.76
4	6/8	1.84
5	10/8	1.11
6	20/8	0.55
7	56/8	0.20

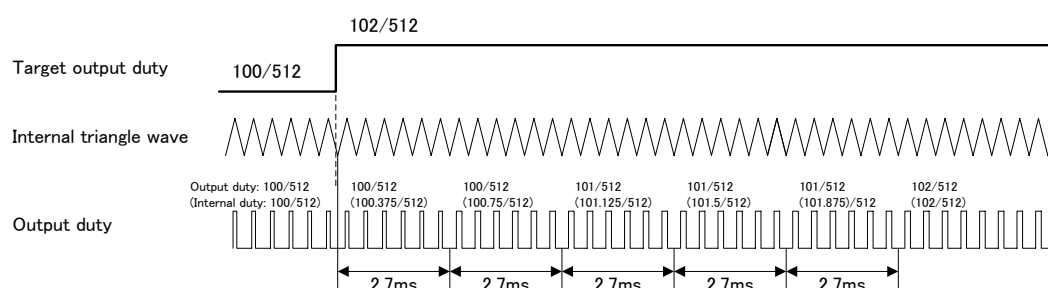

Example: The case of DUTYCHGLIMIT = 2

Figure 11.7

Table 11.7

Item	Soft start	Closed-loop			Open-loop	Mild brake	Reverse brake
		Acceleration	Steady	Deceleration			
Period of changing duty	2.7ms	10.8ms/2.7ms	2.7ms		10.8ms/2.7ms	10.8ms/2.7ms	10.8ms/2.7ms
Variation amount of duty	Duty chg limit for soft start	Duty chg limit	Determined by PI (Maximum variation amount is Duty chg limit)		Duty chg limit	Duty chg limit	Duty chg limit

11.1.7. Output current for the gate of external MOSFET

TC78B027FTG drives external MOSFETs. This IC contains six half bridge pre-drivers and drives high-side and low-side Nch-MOSFETs. The voltage for high-side gate of MOSFET is $V_M + 8V$ (typ.). The voltage for low-side gate of MOSFET is $8V$ (typ.). The register, ISOURCE_SEL, ISINK_SEL set a driving current to the gate.

Table 11.8 The setting of source current for MOSFET

ISOURCE_SEL [2:0]	Source current (mA)
000	10.0
001	13.9
010	19.3
011	26.8
100	37.3
101	51.8
110	72.0
111	100.0

Table 11.9 The setting of sink current for MOSFET

ISINK_SEL [2:0]	Sink current (mA)
000	20.0
001	27.8
010	38.6
011	53.7
100	74.6
101	103.6
110	143.9
111	200.0

11.1.8. Limitation of step of reducing rotation speed

Limiting the step of reducing rotation speed, motor locking can be avoided.

Table 11.10 The setting of step of speed

RPMLIMIT[2:0]	Step of speed(rpm)
000	No limit
001	512
010	2200
011	3800
100	5400
101	7000
110	8600
111	10240

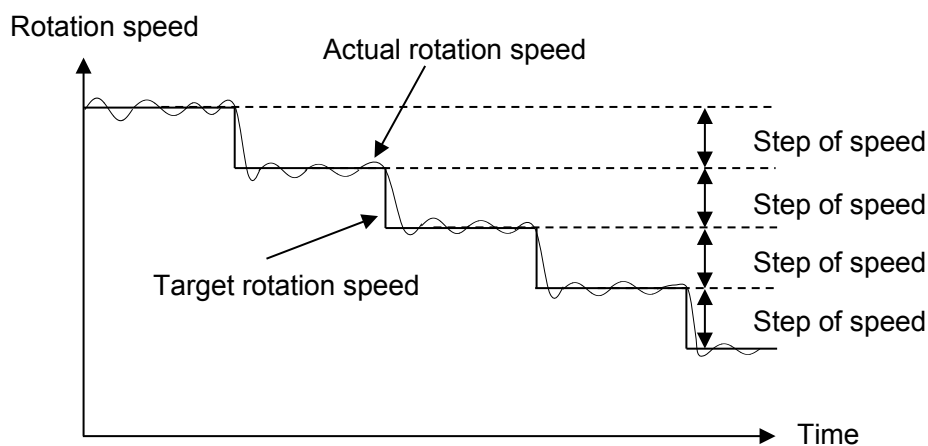

Figure 11.8 Diagram of reaching a target speed

11.2. Input / Output Signals

11.2.1. SPD

SPD pin controls the motor start, the motor stop, and the rotation speed.

PWM duty signal input or analog voltage signal input can be configured by the register. Also, the polarity of the signal can be configured by the register.

Table 11.11 Polarity of SPD

	Positive logic(Default)	Negative logic
Analog voltage input	V _{VSP(L)} : SPD command = 0 (0%) V _{VSP(H)} : SPD command = 512(100%)	V _{VSP(L)} : SPD command = 512 (100%) V _{VSP(H)} : SPD command = 0 (0%)
PWM duty input	H active	L active(Note1)

Note1: The polarity of the input signal is inverted inside the IC, and the inverted signal is used as the positive logic SPD.

In case of analog voltage input, the resolution is 9 bit in the voltage range of V_{VSP(L)} to V_{VSP(H)}.

In case of PWM duty input, its frequency range is from 1 kHz to 100 kHz. When the frequency range is from 1 kHz to 20 kHz, the resolution is 9 bit. And when it is 20 kHz or more, the resolution decreases. For example, in case of 40 kHz, the resolution is 8 bit, and in case of 100 kHz, it becomes 7 bit.

In addition, the SPD pin can be also used as the clock input pin for the serial interface (for SCK signal).

11.2.2. DIR

DIR pin controls the motor rotation direction; forward rotation (CW) and reverse rotation (CCW).

Relation of DIR pin polarity and the rotation direction is configured by the register.

Table 11.12 The relation of register and DIR

Register (DIR)	DIR pin	Rotation direction
0	L	CW
	H	CCW
1	L	CCW
	H	CW

11.2.3. ALERT

ALERT pin is an open drain type output pin. When an abnormal state (over current, over temperature, motor lock, or under voltage for charge pump) is detected, this pin outputs low signal. In addition, this pin can be also used as the data output pin for serial interface (for SDO signal) when the serial interface is 3 lines type. If a serial interface has 2 lines, ALERT pin outs only ALERT signal.

The fault alarm which means low speed activates when the starting rotation speed which is set by STARTRPM is the number which is described in table below over ten seconds. Fault alarm is released when the rotation speed reaches over 70% of the STARTRPM.

Table 11.13 The condition of low speed(Fault alarm)detection

Starting rotation speed setting	Threshold of detection
STARTRPM ≥ 1000rpm	STARTRPM x 50%
700rpm ≥ STARTRPM > 1000rpm	STARTRPM – 500rpm
288rpm ≥ STARTRPM > 700rpm	200rpm
STARTRPM < 288 rpm	Do not detect

ALERT pin signal is defined as table below.

Table 11.14 Register setting vs FG and ALERT

Register			FG output signal(Note1)		ALERT output signal(Note 2)	
RDSEL	ALRMSEL	ALERTINV	Signal	Polarity	Signal	Polarity
0	0	0	FG	—	Lock / Low voltage of charge pump / ISD / TSD	L
0	0	1	FG	—	Lock / Low voltage of charge pump / ISD / TSD	H
0	1	0	FG	—	Low speed(Fault alarm) / Low voltage of charge pump / ISD / TSD(Note3)	L
0	1	1	FG	—	Low speed(Fault alarm) / Low voltage of charge pump / ISD / TSD(Note3)	H
1	0	0	Lock	L	Lock / Low voltage of charge pump / ISD / TSD	L
1	0	1	Lock	L	Lock / Low voltage of charge pump / ISD / TSD	H
1	1	0	Low speed (Fault alarm)	L	Low speed(Fault alarm) / Low voltage of charge pump / ISD / TSD(Note3)	L
1	1	1	Low speed (Fault alarm)	L	Low speed(Fault alarm) / Low voltage of charge pump / ISD / TSD(Note3)	H

Note 1 : When FG pin signal is lock or Low-speed(Fault alarm), its polarity is always “L” and the level of signal is “L”. FG pin outs “L” in 3ms when the power on or reboot from STBY mode.

Note 2 : When REVALERT is set to “1”, ALERT signal is out in the reverse rotation detection.

Note 3 : Low speed(Fault alarm) / Low voltage of charge pump / ISD / TSD(Note3) appear immediately after failure occurring

11.2.4. HP, HM

Pins of HP and HM are input pins for Hall signals.

In case of using Hall element, please input signals whose characteristics are shown below.

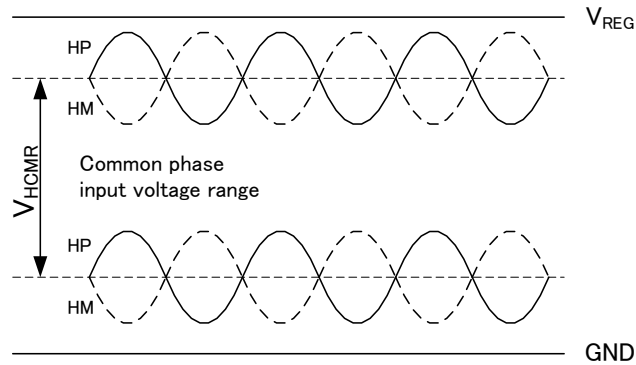

Figure 11.9 Hall signal waveform

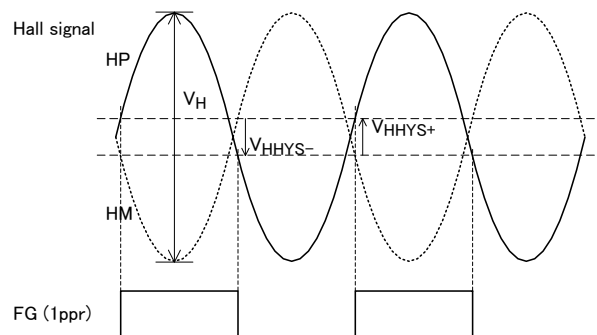

Table 11.10 Hall and FG signal waveform

Note : In case of using Hall IC, the Hall signal must be input to HP pin. Voltage of HM pin should be fixed.

As default, please align the Hall sensor so that the relationship between Hall signals and induced voltage is as charts below.

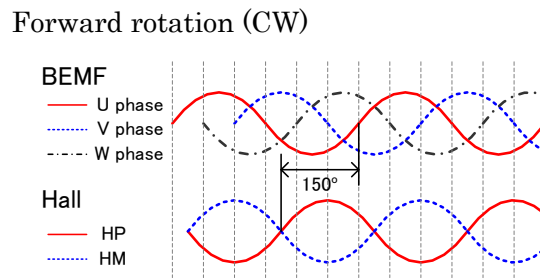

Figure 11.11 The waveform of Hall signal and induced voltage in CW

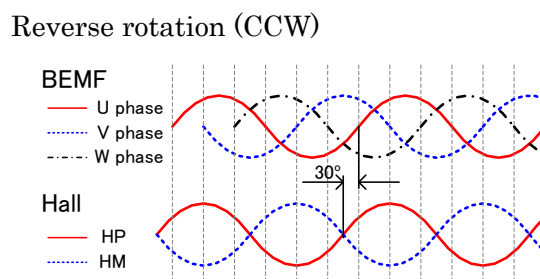

Figure 11.12 The waveform of Hall signal and induced voltage in CCW

Figure below is the example of the default Hall position.

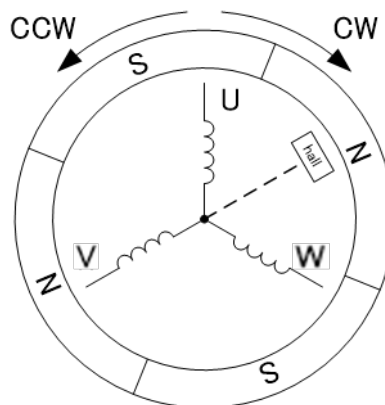

Figure 11.13 Example of the default position of Hall element

11.2.5. FG

FG pin is an open drain type output pin. It outputs the rotation speed signal that is obtained from the Hall signal. According to the register setting, FG pin can also output RDO signal when motor lock is detected. RDO signal is low level in motor lock detection.

In addition, FG pin can be also used as the data input or input/output pin for serial interface (for SDI or SIO signal).

1ppr(pulse per revolution)、3ppr、2.4ppr、0.5ppr can be selected as FG signal.
Below table show the number of FG pulse per 1 rotation of motor.

Table 11.15 Relation of FG signal setting and the number of output pulses per one motor cycle

FGSEL[2:0]	FG signal setting	Number of motor poles				
		2poles	4poles	6poles	8poles	10poles
000	1ppr	1	2	3	4	5
001	2/3 ppr	2/3	4/3	2	8/3	10/3
010	1/2 ppr	0.5	1	1.5	2	2.5
011	2 ppr	2	4	6	8	10
100	3ppr	3	6	9	12	15
101	2.4 ppr	2.4	4.8	7.2	9.6	12
110	1/3 ppr	1/3	2/3	1	4/3	5/3
111	Don't use					

Note: FG pin outputs the signal when the frequency of the Hall signal is 1Hz or more.

When the frequency of the Hall signal is less than 1Hz, FG signal is fixed to Hi-Z.

Note: When FG signal is set to 1ppr, a signal synchronized with the Hall signal is output.

When FG signal is set to the others, internal processed result is output.

FG pin can be also used as the data input pin for serial interface (for SDI signal) when the serial interface is 3 lines type. If a serial interface has 2 lines, FG pin can be also used as the data input/output pin for serial interface (for SIO).

11.2.6. BRAKE

BRAKE pin is for controlling the motor braking function. TC78B027FTG has several braking functions, motor off, short brake, reverse brake, mild brake.

Table 11.16

BRAKE pin	Register		Motor status
	BRK_INV	BRK_MODE[1:0]	
L	0:Positive polarity	Don't care	No brake
L	1:Negative polarity	00	No brake
L	1:Negative polarity	01	Short brake
L	1:Negative polarity	10	Reverse brake
L	1:Negative polarity	11	Mild brake
H	0:Positive polarity	00	No brake
H	0:Positive polarity	01	Short brake
H	0:Positive polarity	10	Reverse brake
H	0:Positive polarity	11	Mild brake
H	1:Negative polarity	Don't care	No brake

Table 11.17

Driving status right after power on	BRAKEALT	ALARMSEL	Status of ALERT pin
Short brake	Don't care	Don't care	Low voltage of charge pump / ISD / TSD
Reverse brake	0	0	Low voltage of charge pump / ISD / TSD
Reverse brake	1	0	Low voltage of charge pump / ISD / TSD
Reverse brake	Don't care	1	Lock / Low voltage of charge pump / ISD / TSD
Mild brake	Don't care	Don't care	Low voltage of charge pump / ISD / TSD

11.3. Speed Control

11.3.1. Closed loop

The basic speed curve (relation between SPD signal value and rotation speed) of closed loop speed control is as follows:

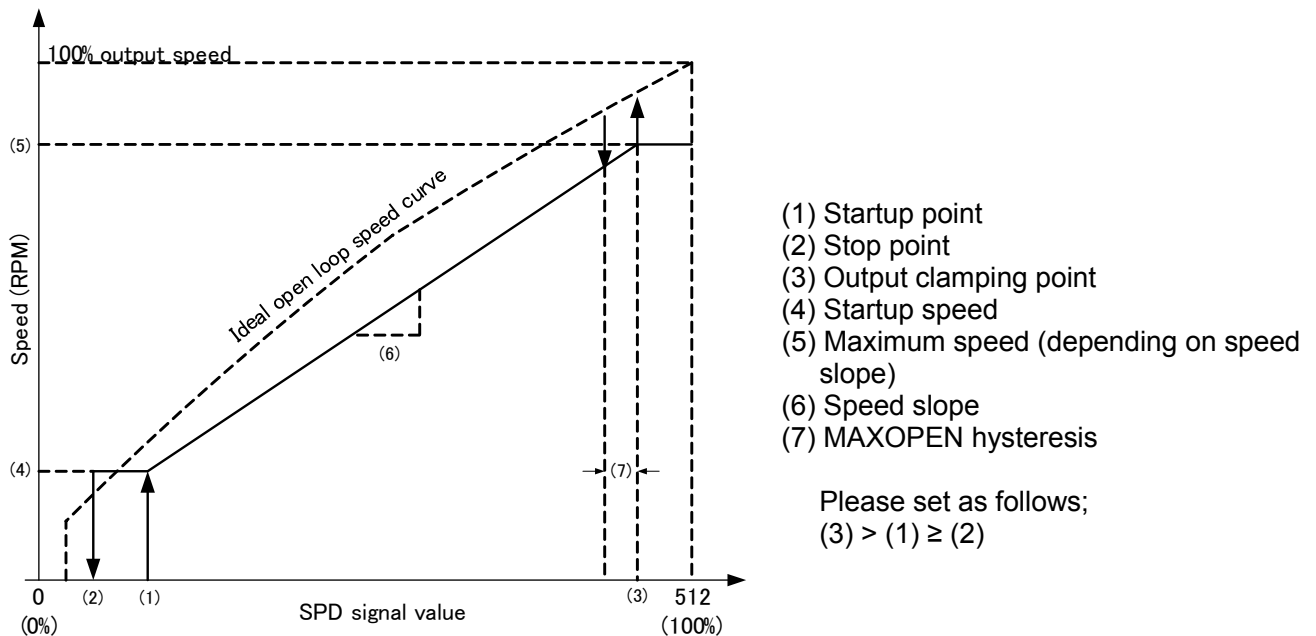

Figure 11.14 Speed slope example in closed loop control

(1) Startup point:

Output is enabled when SPD signal value exceeds the startup threshold. The threshold range is from 0 (0 %) to 255 (49.8 %) with a 0.2 % resolution. It is set by the 8-bit register STARTDUTY.

$$SPD \text{ duty to enable output (\%)} = 100 \times STARTDUTY / 512$$

(2) Stop point:

Output is disabled when SPD signal value decreases to the stop threshold. The threshold range is from 0 (0 %) to 254 (49.6 %) with a 0.4 % resolution. It is set by the 7-bit register STOPDUTY.

$$SPD \text{ duty to disable output (\%)} = 200 \times STOPDUTY / 512$$

(3) Output clamping point and (7) MAXOPEN hysteresis:

In case MAXDUTY = 0: When SPD signal value exceeds the output clamping threshold, the rotation speed is fixed. The threshold range is from 257 (50.2 %) to 512 (100 %) with a 0.2 % resolution. It is set by the 8-bit register MAXDUTY.

$$SPD \text{ duty to clamp output (\%)} = 100 \times (257 + MAXDUTY) / 512$$

In case MAXOPEN = 1: When SPD signal value exceeds the output clamping threshold, the control switches to open loop speed control. The output duty during open loop speed control corresponds to SPD signal value. The hysteresis of SPD signal value to let the control switch back to closed loop speed control range is from 2 (0.4 %) to 32 (6.25 %) with a 0.4 % resolution. It is set by the 4-bit register MAXDUTYHYS.

$$SPD \text{ duty hys (\%)} = 200 \times (MAXDUTYHYS + 1) / 512$$

(4) Startup speed:

The minimum rotation speed in startup is set by the 12-bit register STARTRPM. Setting range is from 0 to 4095 RPM with 1 RPM resolution.

$$Startup \text{ speed (RPM)} = STARTRPM$$

(5) Maximum speed and (6) Speed slope:

Maximum speed depends on the speed slope, which is set by the register SPEEDSLOP. It is a 14-bit register.

$$SPEEDSLOP = 64 \times (Maximum \text{ speed} - Startup \text{ speed}) / (MAXDUTY + 257 - STARTDUTY)$$

Configurations of MAXOPEN, NOSTOP, and MAXOFF registers determine the behavior when SPD signal value is equivalent to the startup (output enabling) point or less.

Table 11.18 Rotation Behavior (SPD signal value ≤ Startup point)

MAXOPEN	NOSTOP	MAXOFF	Target speed		
			SPD = 0 %	0 % < SPD ≤ Startup point	Stop point < SPD ≤ Startup point
0	0	0	0	0	Duty up: 0 Duty down: Startup speed
	0	1	Maximum Speed	0	Duty up: 0 Duty down: Startup speed
	1	0	Startup speed	Startup speed	Startup speed
	1	1	Maximum Speed	Maximum Speed	Startup speed
1	0	0	0	0	Duty up: 0 Duty down: Startup speed
	0	1	100 % Output	0	Duty up: 0 Duty down: Startup speed
	1	0	Startup speed	Startup speed	Startup speed
	1	1	100 % Output	100 % Output	Startup speed

Adding a speed change point to the speed curve is possible.

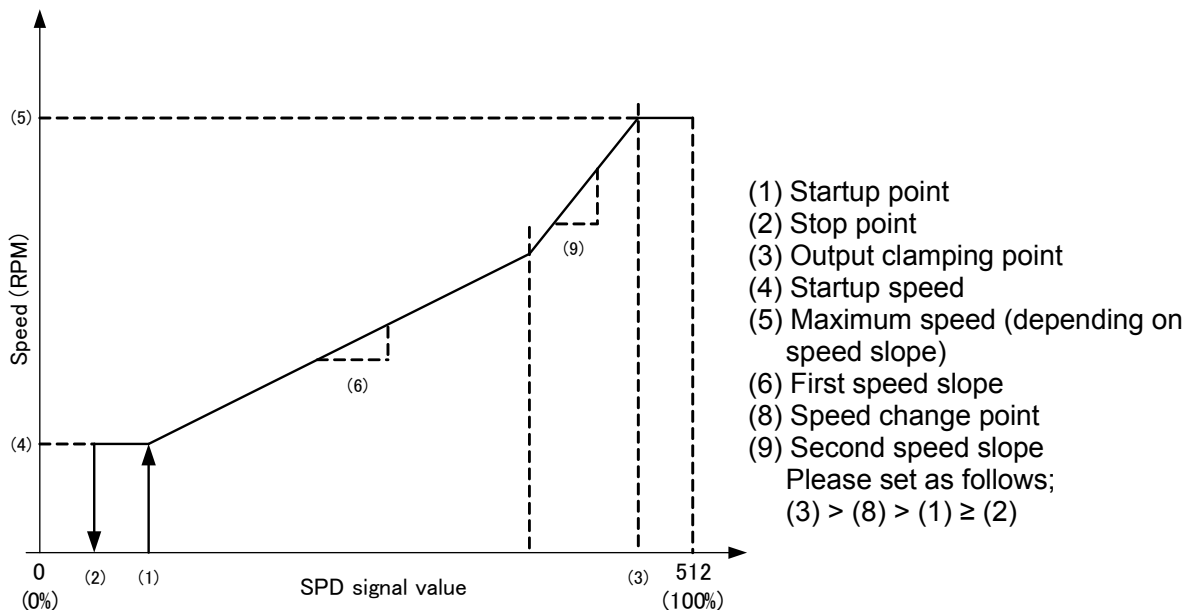

Figure 11.15 Speed Slope Example in Closed loop speed control (in case of adding speed change point)

(8) Speed change point:

The SPD signal value range of the speed change point is from 0 (0.4 %) to 510 (99.6 %) with a 0.4 % resolution. It is set by the 8-bit register CHANGEDUTY.

$$SPD \text{ duty of change point } (\%) = 200 \times CHANGEDUTY / 512$$

In case of un-using the speed change point, set CHANGEDUTY to 0.

(9) Second speed slope:

After passing the speed change point, the register SPEEDSLOP2 sets the speed slope.

In case of DIR50=1, rotation direction of motor is controlled by the duty of SPD signal.
 Motor rotates forward direction when SPD duty is 50% or more. Motor rotates reverse direction when SPD duty is under 50%.

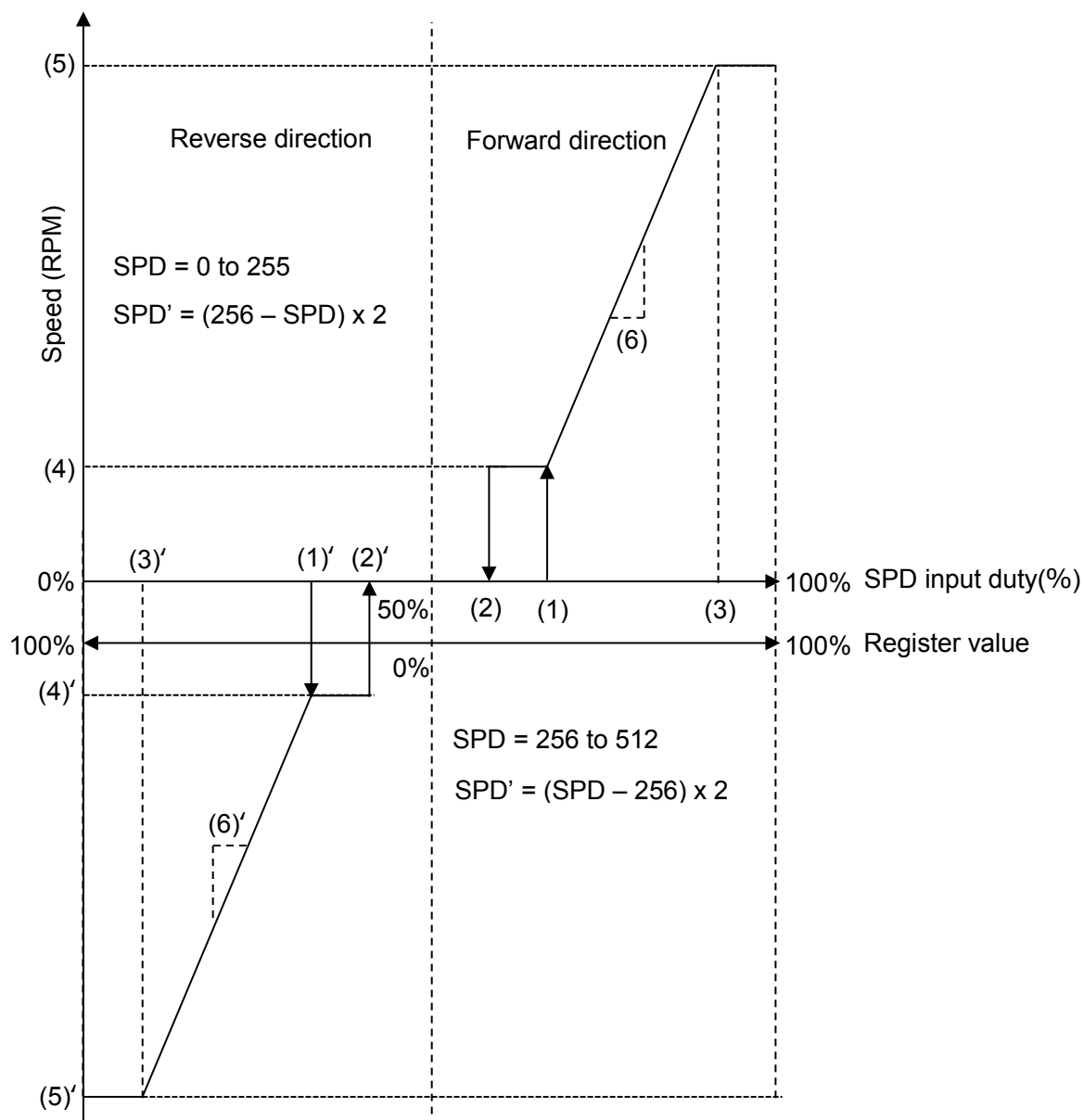

Figure 11.16 Speed Slope Example in Closed loop speed control (in case of DIR50=1)

11.3.2. Open loop

The basic speed curve (relation between SPD signal value and output duty) of open loop speed control is as follows ;

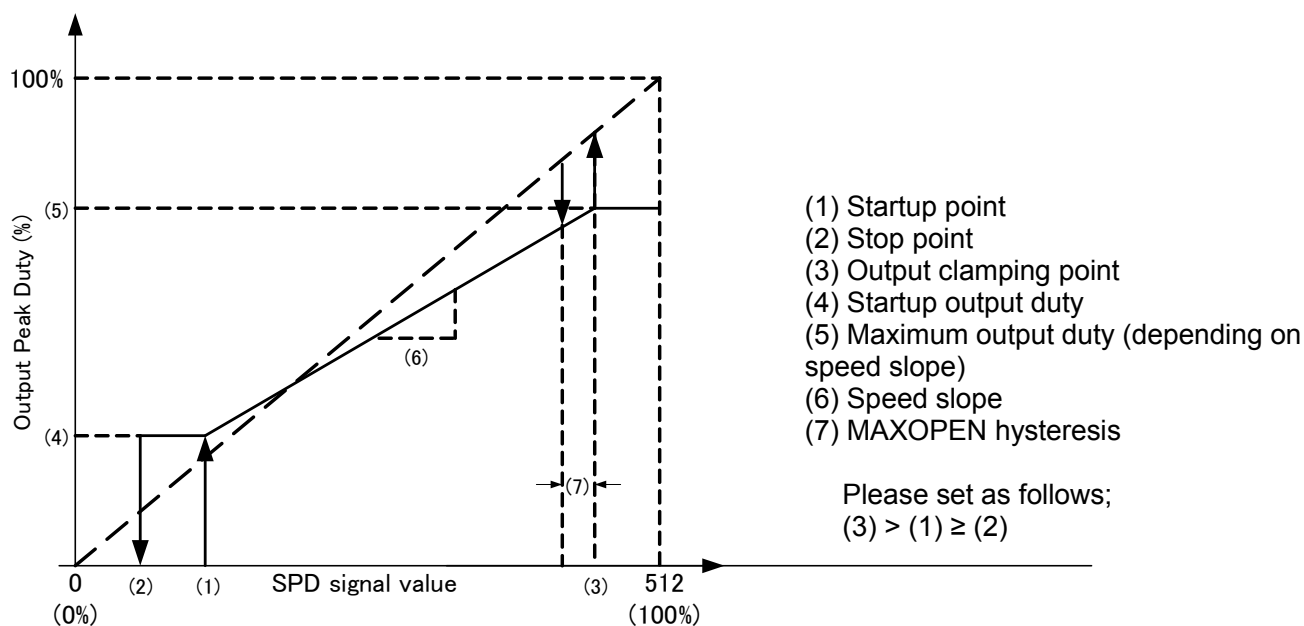

Figure 11.17 Speed slope example in Open loop speed control

(1) Startup point:

Output is enabled when SPD signal value exceeds the startup threshold. The threshold range is from 0 (0 %) to 255 (49.8 %) with a 0.2 % resolution. It is set by the 8-bit register STARTDUTY.

$$SPD \text{ duty to enable output (\%)} = 100 \times STARTDUTY / 512$$

(2) Stop point:

Output is disabled when SPD signal value decreases to the stop threshold. The threshold range is from 0 (0 %) to 254 (49.6 %) with a 0.4 % resolution. It is set by the 7-bit register STOPDUTY.

$$SPD \text{ duty to disable output (\%)} = 200 \times STOPDUTY / 512$$

(3) Output clamping point and (7) MAXOPEN hysteresis:

In case MAXDUTY = 0: When SPD signal value exceeds the output clamping threshold, the output duty is fixed. The threshold range is from 257 (50.2 %) to 512 (100 %) with a 0.2 % resolution. It is set by the 8-bit register MAXDUTY.

$$SPD \text{ duty clamp output (\%)} = 100 \times (257 + MAXDUTY) / 512$$

In case MAXOPEN = 1: When SPD signal value exceeds the output clamping threshold, the output duty becomes corresponding to SPD signal value. The hysteresis range of SPD signal value to let the output return to original speed curve is from 2 (0.4 %) to 32 (6.25 %) with a 0.4 % resolution. It is set by the 4-bit register MAXDUTYHYS.

$$SPD \text{ duty hys (\%)} = 200 \times (MAXDUTYHYS + 1) / 512$$

(4) Startup output duty:

The minimum output duty in startup is set by an upper 8-bit of the 12-bit register STARTRPM. Setting range is from 0 (0 %) to 255 (49.8 %) with a 0.2 % resolution.

$$Startup \text{ output duty (\%)} = 100 \times STARTRPM[11:4] / 512$$

(5) Maximum output duty and (6) Speed slope:

Maximum output duty depends on the speed slope, which is set by the register SPEEDSLOP. It is a 14-bit register.

$$SPEEDSLOP = 2^{19} \times (Maximum \text{ output duty (\%)} - Startup \text{ output duty (\%)}) / (MAXDUTY + 257 - STARTDUTY) / 100$$

Configurations of MAXOPEN, NOSTOP, and MAXOFF registers determine the behavior when SPD signal value is equivalent to the startup (output enabling) point or less.

Table 11.19 Rotation Behavior (SPD signal value ≤ Startup point)

MAXOPEN	NOSTOP	MAXOFF	Output Duty		
			SPD = 0 %	0 % < SPD ≤ Startup point	Stop point < SPD ≤ Startup point
0	0	0	0	0	Duty up: 0 Duty down: Startup Output
	0	1	Maximum Output	0	Duty up: 0 Duty down: Startup Output
	1	0	Startup Output	Startup Output	Startup Output
	1	1	Maximum Output	Maximum Output	Startup Output
1	0	0	0	0	Duty up: 0 Duty down: Startup Output
	0	1	100 % Output	0	Duty up: 0 Duty down: Startup Output
	1	0	Startup Output	Startup Output	Startup Output
	1	1	100 % Output	100 % Output	Startup Output

Adding a speed change point to the speed curve is possible.

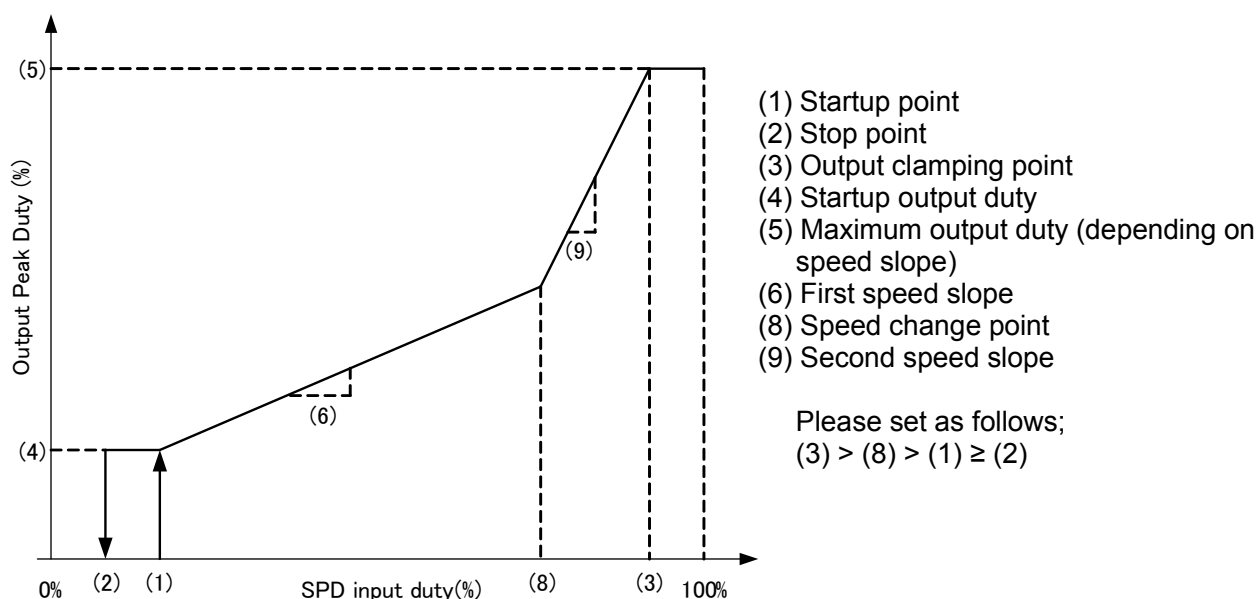

Figure 11.18 Speed Slope Example in Open loop speed control (in case of adding speed change point)

(8) Speed change point:

The SPD signal value range of the speed change point is from 0 (0.4 %) to 510 (99.6 %) with a 0.4 % resolution. It is set by the 8-bit register CHANGEDUTY.

$$SPD \text{ duty of change point } (\%) = 200 \times CHANGEDUTY / 512$$

In case of unusing the speed change point, set CHANGEDUTY to 0.

(9) Second speed slope:

After passing the speed change point, the register SPEEDSLOP2 sets the speed slope.

In case of DIR50=1, rotation direction of motor is controlled by the duty of SPD signal.
 Motor rotates forward direction when SPD duty is 50% or more. Motor rotates reverse direction when SPD duty is under 50%.

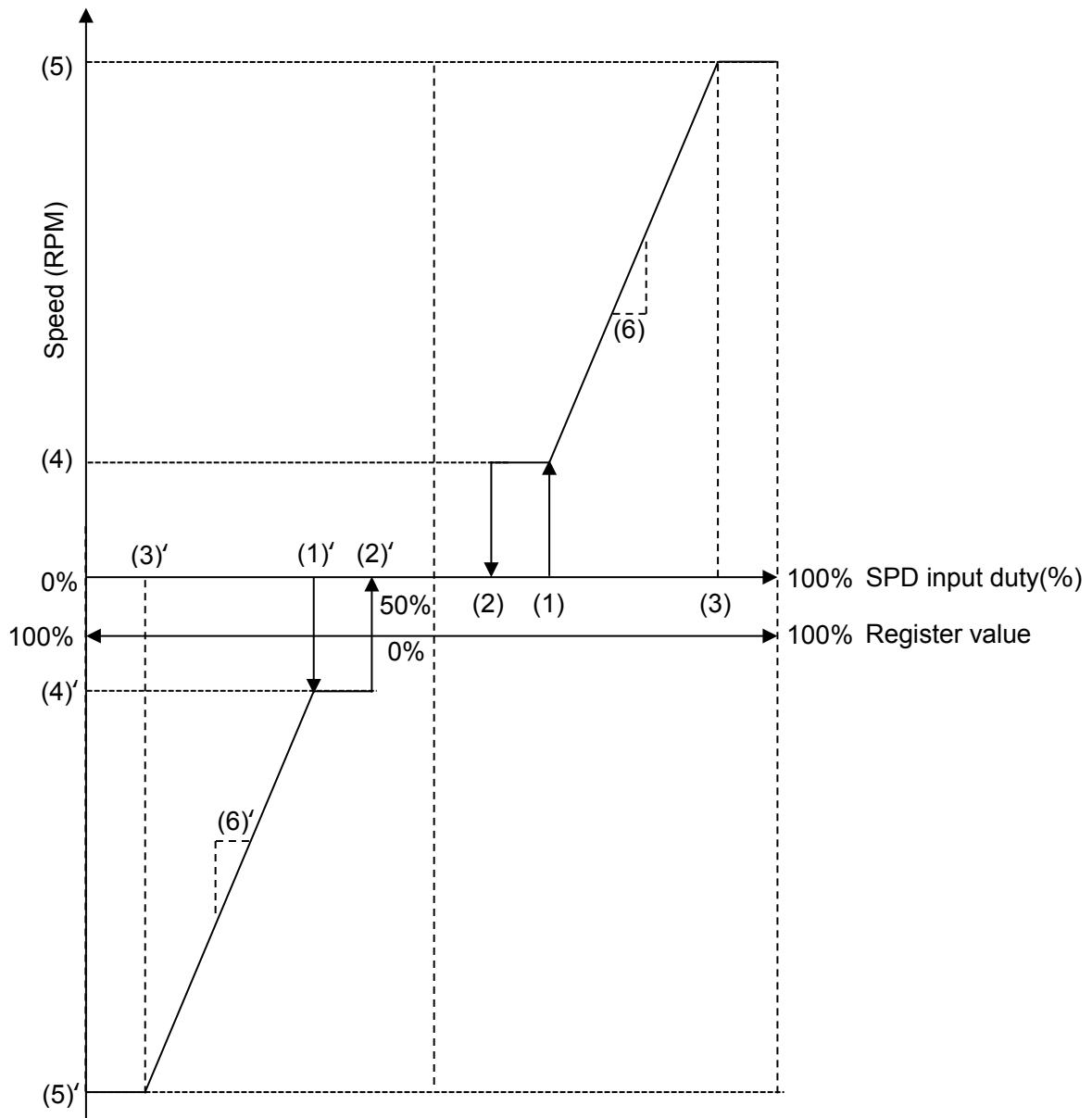

Figure 11.19 Speed Slope Example in Open loop speed control (in case of DIR50=1)

11.4. Serial I/F and NVM

Data of internal registers and non-volatile memory (NVM) can be configured via serial interface. When FG pin is Hi-Z, receiving serial commands is possible.

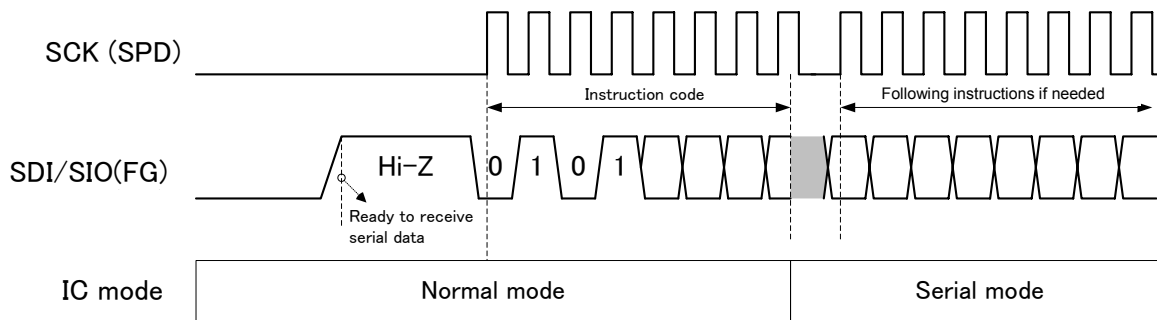

Figure 11.20 Timing chart

After receiving command code, IC enters into serial mode. Motor stops if IC enters into serial mode. FG pin is fixed Hi-Z.

After inputting command code and following data (if needed),
 If ENB of Status Register is “0”, IC returns to normal mode.
 If ENB of Status Register is “1”, IC stays in serial mode.

11.4.1. Serial commands

Table 11.20 Serial commands (Instruction Code)

Command	Code	Description	Following Data
SR_READ	010 01 001	Read status register	8-bit data out
SR_WRITE	010 01 010	Write status register	8-bit data in
REG_READ	010 10 001	Read normal register	8-bit addr in + 16-bit data out
REG_WRITE	010 10 010	Write normal register	8-bit addr in + 16-bit data in
NVM_LOAD	010 11 001	Load NVM data to normal register	None
NVM_SAVE	010 11 010	Store data of normal register to NVM	None
NVM_ABORT	010 11 100	Terminate NVM writing process forcibly	None

11.4.2. Status register

Table 11.21 Status Register (SR)

Bit 7	Bit 6	Bit 5	Bit 4	Bit 3	Bit 2	Bit 1	Bit 0
—	—	—	CAL_ERR	NVM_WR	WIRE	ENB	BUSY

Table 11.22

Name	Description	Detail
BUSY	State of register processing	BUSY=0: Standby BUSY=1: Under processing (REG_READ, REG_WRITE, NVM_LOAD, NVM_SAVE, NVM_COPY)
ENB	Serial command enable setting	ENB=0: Normal mode (Only SR_READ SR_WRITE is acceptable.) ENB=1: Serial mode (All commands are acceptable.)
WIRE	Serial communication mode setting	WIRE=0: 3-wire mode (SCK=SPD, SDI=FG, and SDO=ALERT) WIRE=1: 2-wire mode (SCK=SPD and SDIO=FG)
NVM_WR	NVM mode setting	NVM_WR=0: READ enable, WRITE disable NVM_WR=1: READ disable, WRITE enable
CAL_ERR	Result of Hall position detection	CAL_ERR=0: Success CAL_ERR=1: Failure

11.4.3. Normal register

Table 11.23 Register map

ADDR	Bit	Name	Description	Default
0	15:0	USERID[15:0]	-	0
1	15	NOSTOP	Non-stop mode (0: disable, 1: enable)	0
1	14:8	STOPDUTY[6:0]	Stop duty	0
1	7:0	STARTDUTY[7:0]	Startup duty	0
2	15:8	CHANGEDUTY[7:0]	Speed change point duty	0
2	7:0	MAXDUTY[7:0]	Maximum duty	0
3	15:4	STARTRPM[11:0]	Rotation speed in startup	0
3	3:0	MAXDUTYHYS[3:0]	Recovery hysteresis from open loop to closed loop speed control	0
4	15:2	SPEEDSLOPE[13:0]	Speed slope	0
4	1	MAXOPEN	Switching to open loop speed control when SPD signal value exceeds the threshold (0: disable, 1: enable)	0
4	0	MAXOFF	Rotating with full speed when SPD signal value corresponds to the startup point or less. (0: disable, 1: enable)	0
5	15:2	SPEEDSLOPE2[13:0]	Speed slope after passing speed change point	0
5	1	REVALERT	ALERT output in reverse detection	0
5	0	OPENLOOP	OPEN LOOP/CLOSEDLOOP (0: closed loop, 1: open loop)	0
6	15	KiX	To eight times the KI (0: x1, 1: x8)	0
6	14:8	Ki[6:0]	KP (0 to 127)	0
6	7	KpX	To eight times the KI (0: x1, 1: x8)	0
6	6:0	Kp[6:0]	KI (0 to 127)	0
7	15	STBY	Standby mode (0: disable, 1: enable)	0
7	14	DIR	Relation of DIR pin polarity and rotation direction (0: positive, 1: negative)	0
7	13:11	POLEPAIR[2:0]	Pair of motor poles	0
7	10:9	MAXSPEED[1:0]	Maximum rotation speed	0
7	8	HALLINV	Hall signal polarity conversion (0: positive, 1: negative)	0
7	7:6	HALLPOS[1:0]	Hall alignment sector	0
7	5:0	HALLOFFSET[5:0]	Hall position offset	0
8	15	RDSEL	The signal selection to output FG pin (0: FG signal, 1: RDO signal or ALARM signal)	0
8	14:12	FGSEL[2:0]	FG signal type setting	0
8	11	SPDSEL	SPD command type setting (0: Analog voltage input, 1: PWM duty input)	0
8	10	SPDINV	SPD signal polarity conversion (0: positive, 1: negative)	0
8	9	REVBRAKE	Reverse startup (0: disable, 1: enable)	0
8	8	150DRV	150° commutation (0: sine-wave drive, 1: 150° commutation)	0
8	7	ISDLATCH	ISD latch (0: disable, 1: enable)	0
8	6:5	OCPMASK[1:0]	Masking period for current limit	0
8	4:3	OCPHYS[1:0]	Current limit setting	0
8	2:0	PWMSEL[2:0]	Output PWM frequency setting	0
9	15	TON	Lock detection ON period	0
9	14	TOFF	Lock detection OFF period	0

ADDR	Bit	Name	Description	Default
9	13	LOCKDIS	Disable lock detection	0
9	12:10	DUTYCHGLIMIT[2:0]	Duty changing limit	0
9	9:8	STARTFREQ[1:0]	Startup switching frequency	0
9	7:5	STARTCURRENT[2:0]	Startup current limit	0
9	4:0	LATABLE[4:0]	Lead angle table	0
10	15	LASEL	Lead angle selection	0
10	14	BRK_360_SEL	0: 180° reset during mild brake 1: 360° reset during mild brake	0
10	13	OCPDIS	Disable current limit (0: OCP enable, 1: OCP disable)	0
10	12:11	SS_ADD_SEL[1:0]	Soft start current (OCP * 0%, 30%, 40%, 50%)	0
10	10:9	SS_UP_SEL[1:0]	Increasing amount of the current in soft start (OCP * +1%, +2%, +5%, +10%)	0
10	8:6	SS_DUTYCHGLIMIT[2:0]	Duty change limit in soft start phase (equivalent to DUTYCHGLIMIT)	0
10	5	OC_LEVEL	Reference voltage for OCP (0: 0.25V, 1: 0.125V)	0
10	4	DUTY_UP_TIME	Changing period of PWM duty (0: each 2.7ms, 1: each 10.9ms)	0
10	3	ISD_LEVEL	Reference voltage for ISD (0: 1.0V, 1: 0.5V)	0
10	2:0	RPMLIMIT[2:0]	Limit of step of changing rotation speed (No limit, 512rpm, 2200rpm, 3800rpm, 5400rpm, 7000rpm, 8600rpm, 10240rpm)	0
11	15:14	BRK_MODE[1:0]	The setting of brake(No brake, Short brake, Reverse brake, Mild brake)	0
11	13	BRK_INV	Polarity of BRAKE pin (0: positive, 1: negative)	0
11	12:10	WAIT_TIME[2:0]	Wait time after power on(0s, 1s, 2s, 3s, 4s, 5s, 6s, 7s)	0
11	9:8	WAIT_MODE[1:0]	Output status at power on(No brake, Short brake, Reverse brake, Mild brake)	0
11	7	WAIT_CON	Output status after a certain time from power on (0: Brake off after WAIT_TIME from power on, 1: Sustain the brake status which is set by WAIT_MODE after WAIT_TIME from power on)	0
11	6	LOCK_BRK	Short brake setting when locking protection (0: OFF, 1: Short brake)	0
11	5	ALRMSEL	The output setting for ALERT (FG/Lock/Low speed(Fault alarm))	0
11	4	ALERTINV	Polarity of ALERT pin (0: Fault when L, 1: Fault when H)	0
11	3	IND_SEL	DC excitation ON/OFF (0: disable, 1: enable)	0
11	2	SS_LOCK	Lock detection when soft start	0
11	1	ALARM_LAT_SEL	0: Release ALARM when no torque command / brake setting, 1: Sustain ALARM however no torque command / brake setting	0
11	0	ISD_MASK	ISD mask setting (0: enable, 1: disable)	0
12	15:13	ISOURCE_SEL[2:0]	High side / Low side Source current	0
12	12:10	ISINK_SEL[2:0]	High side / Low side Sink current	0
12	9:8	DEADTIME[1:0]	Dead time(200ns 500ns 1μs 1.5μs)	0
12	7	DIR50	DIR50 signal (0: disable, 1: enable)	0
12	6:5	RS_SEL[1:0]	Input filter of OC pin (None, 200kHz, 100kHz, 50kHz)	0
12	4	ANTITHROUGH	Dead time auto tuning (0: Auto, 1: Manual)	0
12	3:2	INPACEDGE	-	0

ADDR	Bit	Name	Description	Default
12	1	INPACAPPLY	-	0
12	0	BRAKEALT	The setting of lock detection when in reverse brake	0
13	15:6	Trq_duty[9:0]	SPD command	0
13	5	UNUSED	Don't care	0
13	4:3	Hall_off_Freq[1:0]	Hall position detection, frequency of forced rotation	0
13	2:1	Hall_cal_Freq[1:0]	Hall position detection, Frequency of detection when starting	0
13	0	Hall_cal	Hall position detection enable	0

11.4.4. Flowchart of writing Non-Volatile Memory (NVM)

Flow chart of NVM write is as follows;

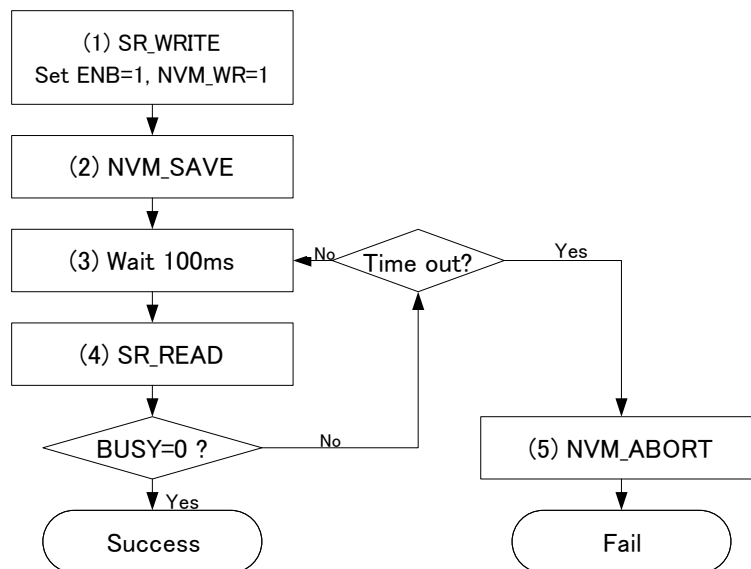

Figure 11.21 NVM writing flowchart

Writing period may be longer according to the operating conditions. In case BUSY does not return to 0 over 1.3 s, it is supposed to be a writing error. Please terminate the writing process forcibly by NVM_ABORT command.

After NVM writing process has completed, always return NVM_WR setting to 0.

11.5. Protection Function

11.5.1. Fault and detection table

Fault	Detect condition	Release conditions	Behavior in faults	ALERT output
Lock	Zero cross of Hall signal does not appear over T_{ON}	Detect rotation two times	•Output OFF •Automatic recover after T_{OFF}	Yes
OCP	Current > OCP threshold	SPD=0 or <Sine-wave> rotation two times under condition of current < OCP <150°> PWM release	•Output OFF •Switch from sine-wave to 150°	No
ISD	Current > ISD threshold	Rotation two times under the condition of "current < ISD threshold"	•Output OFF •Automatic recover after T_{OFF}	Yes
OVP	VM > 17.2V	SPD = 0 or rotation two times under the condition of "VM < 16.8V", "150°"	Switch from sine-wave to 150°	No
Charge pump under voltage	VCP-VM < 3.7V	VCP-VM > 4.0V	Output OFF	Yes
UVLO	VM < 3.9V	VM > 4.2	IC off	No
TSD	$T_j > 170^\circ\text{C}$ (When IC starts up, over 130°C)	$T_j < 130^\circ\text{C}$	Output OFF	Yes

11.5.2. Lock detection

It is recognized as a lock state if the zero cross of the Hall signal is not detected for a certain period (t_{ON}). In this case, the output is turned off for a certain period (t_{OFF}). Then, the IC output is recovered automatically. During output OFF period, the FG pin is Hi-Z. Lock detection period and output OFF period can be configured by registers

Table 11.24 Lock detecting period

TON	Lock detecting period (T_{ON})
0	0.3 s
1	0.6 s

Table 11.25 Output off period

TOFF	Output off period (T_{OFF})
0	$T_{ON} \times 10 \text{ s}$
1	$T_{ON} \times 5 \text{ s}$

Table 11.26 Lock detecting function setting

LOCKDIS	Lock detecting function
0	Enable
1	Disable

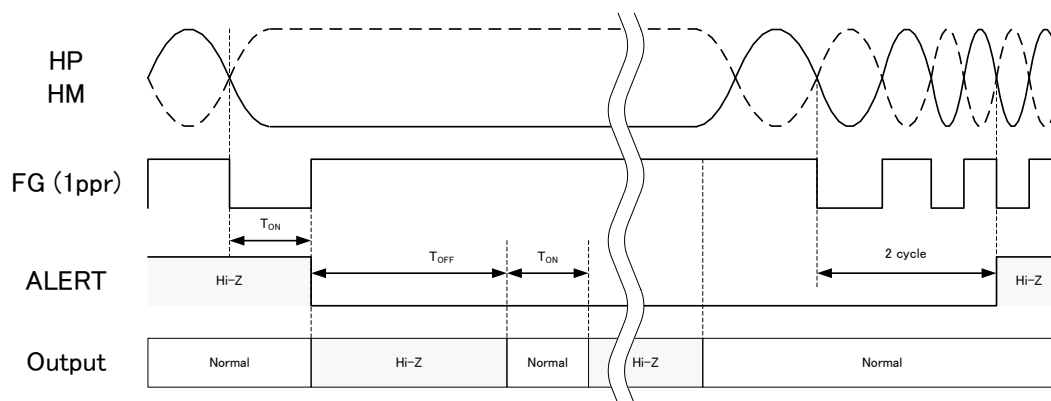

Figure 11.22 Timing chart of lock detection and recovery

11.5.3. Output current limit protection (OCP)

This function is incorporated to limit the motor current. It monitors the motor current with using an external shunt resistor.

In case of sine-wave drive, when the output current exceeds the current limit detection threshold V_{oc} , driving mode is switched from sine-wave drive to 150° commutation. After switching to 150° commutation, the current is limited for every PWM cycle. Current limit control value is lower than the current limit detection threshold. After no more current hits the current limit control value, 150° commutation will continue 2 more cycles before driving mode returns to the sine-wave drive.

In case of 150° commutation mode, the current limit detection threshold is as same as the current limit control value. Current is limited for every PWM cycle.

Table 11.27

OC_LEVEL	OCPHYS [1:0]	Sine-wave drive mode		150° commutation mode	
		Current limit detection threshold V_{oc}	Current limit control value	Current limit detection threshold V_{oc}	Current limit control value
0	00	0.250V	0.250V x 0.95	0.250V	0.250V
0	01	0.250V	0.250V x 0.90	0.250V	0.250V
0	10	0.250V	0.250V x 0.85	0.250V	0.250V
0	11	0.250V	0.250V x 0.80	0.250V	0.250V
1	00	0.125V	0.125V x 0.95	0.125V	0.125V
1	01	0.125V	0.125V x 0.90	0.125V	0.125V
1	10	0.125V	0.125V x 0.85	0.125V	0.125V
1	11	0.125V	0.125V x 0.80	0.125V	0.125V

There is a digital filter so that avoiding malfunction.

Table 11.28 Filtering time

OCPMASK [1:0]	CLK 数	Filtering time
00	No filter	
01	6	500ns

10	7	666ns
11	8	750ns

There is a filter on the OC pin to avoid malfunction.

Table 11.29 Filter setting on OC pin

RS_SEL[1:0]	Cut off frequency
00	None
01	200kHz
10	100kHz
11	50kHz

11.5.4. Over current protection (ISD)

This function monitors the current of the output power transistor by shunt resistor and turns off all output stages when the current value exceeds the detection threshold. It prevents the external MOSFET from flowing over current continuously. While this function is activated, ALERT pin outputs a low level signal.

Automatic recovery or latch can be selected by using the register. In the case of automatic recovery, output resumes automatically after the output OFF period (t_{OFF}) has passed. If the over current condition continues, the protection cycle repeats. If it repeats 8 times in a row, output will not recover, and all output power transistors will keep in off-state. This state is released by re-applying SPD signal or turning on the power again.

In the case of the latch method, output power transistors keep in the off-state after the over current is detected. This state is released by re-applying SPD signal or turning on the power again.

Detection voltage level can be set 1.0V or 0.5V by the setting of NVM. Default level is 1.0V. Filtering time is longer one clock than OCP's time to prevent a malfunction due to pulse current.

11.5.5. Over voltage protection (OVP)

This function is incorporated to prevent VM voltage from rising during motor deceleration. In case of sine-wave drive, driving mode is switched from sine-wave drive to 150° commutation when the VM voltage becomes 17.2 V (typ.) or more. After VM voltage falls to 16.8 V (typ.) or less, 150° commutation continues 2 more cycles before driving mode is switched back to the sine-wave drive.

In case of 150° commutation mode, the over voltage protection is invalid.

11.5.6. Under voltage lockout (UVLO)

When the power supply voltage is less than the IC operation voltage, this function turns off the IC operation to avoid malfunction.

It monitors both VM voltage and VREG voltage. When VM voltage is 3.9 V (typ.) or less, or VREG voltage is 3.7 V (typ.) or less, this function is activated. It has a hysteresis of 0.3 V (typ.). Normal operation resumes when VM voltage is over 4.2 V (typ.), and VREG voltage is over 4.0 V (typ.).

11.5.7. Charge pump under voltage

When the voltage between VCP pin and VM pin is 3.7V(typ.) or less, this function is activated and motor output is fixed Hi-Z. It has a hysteresis of 0.3V(typ.). IC is resumed to normal operation when the voltage is over 4.0V (typ.).

11.5.8. Thermal shutdown (TSD)

Thermal shutdown (TSD) is incorporated.

It operates when IC's junction temperature (T_j) exceeds 170°C (typ.). All outputs are turned off. It has a hysteresis of 40°C (typ.). When IC's junction temperature becomes 130°C (typ.) or less, the operation returns automatically.

12. Reference circuit

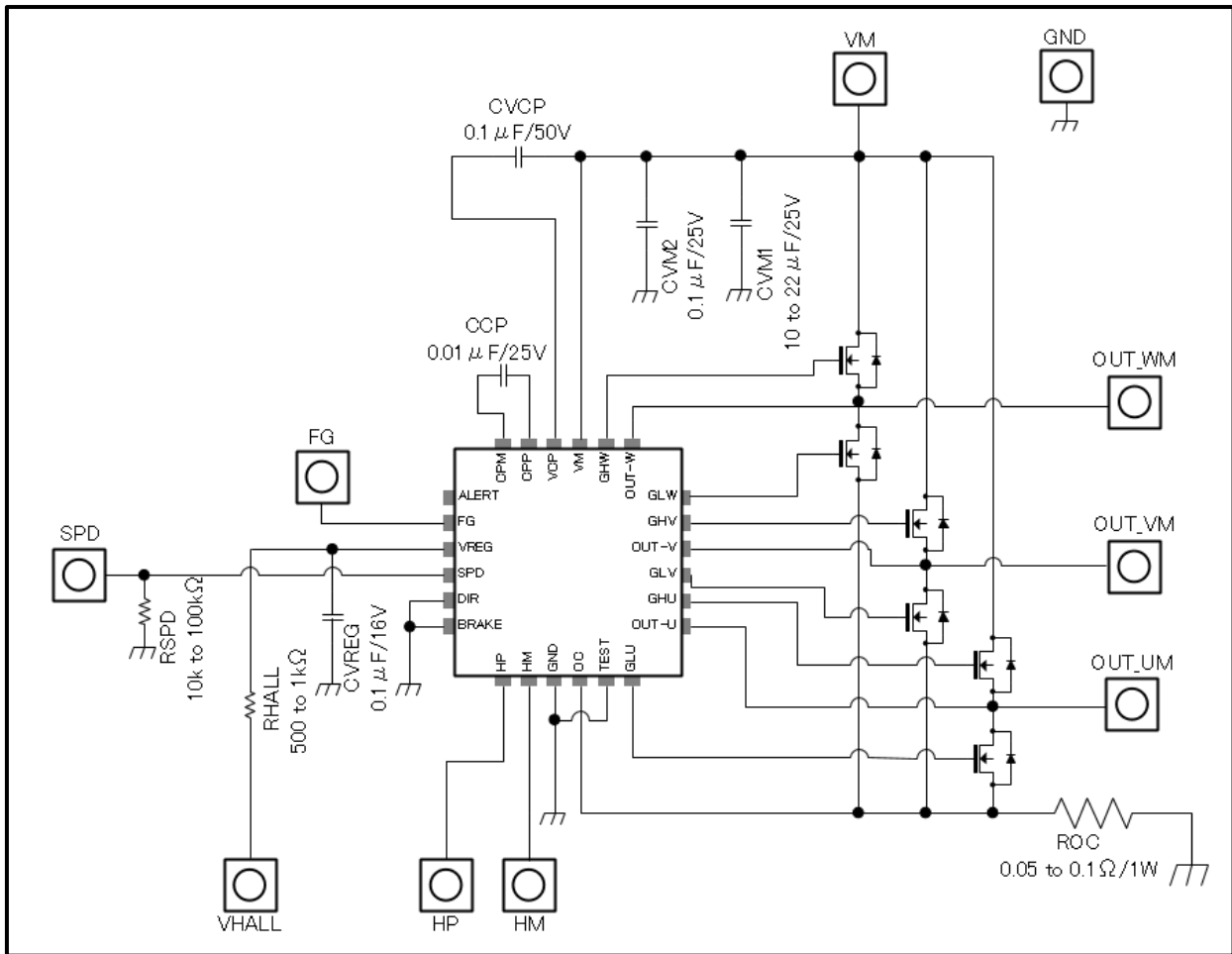

Figure 12.1 Reference circuit

13. Reference board layout

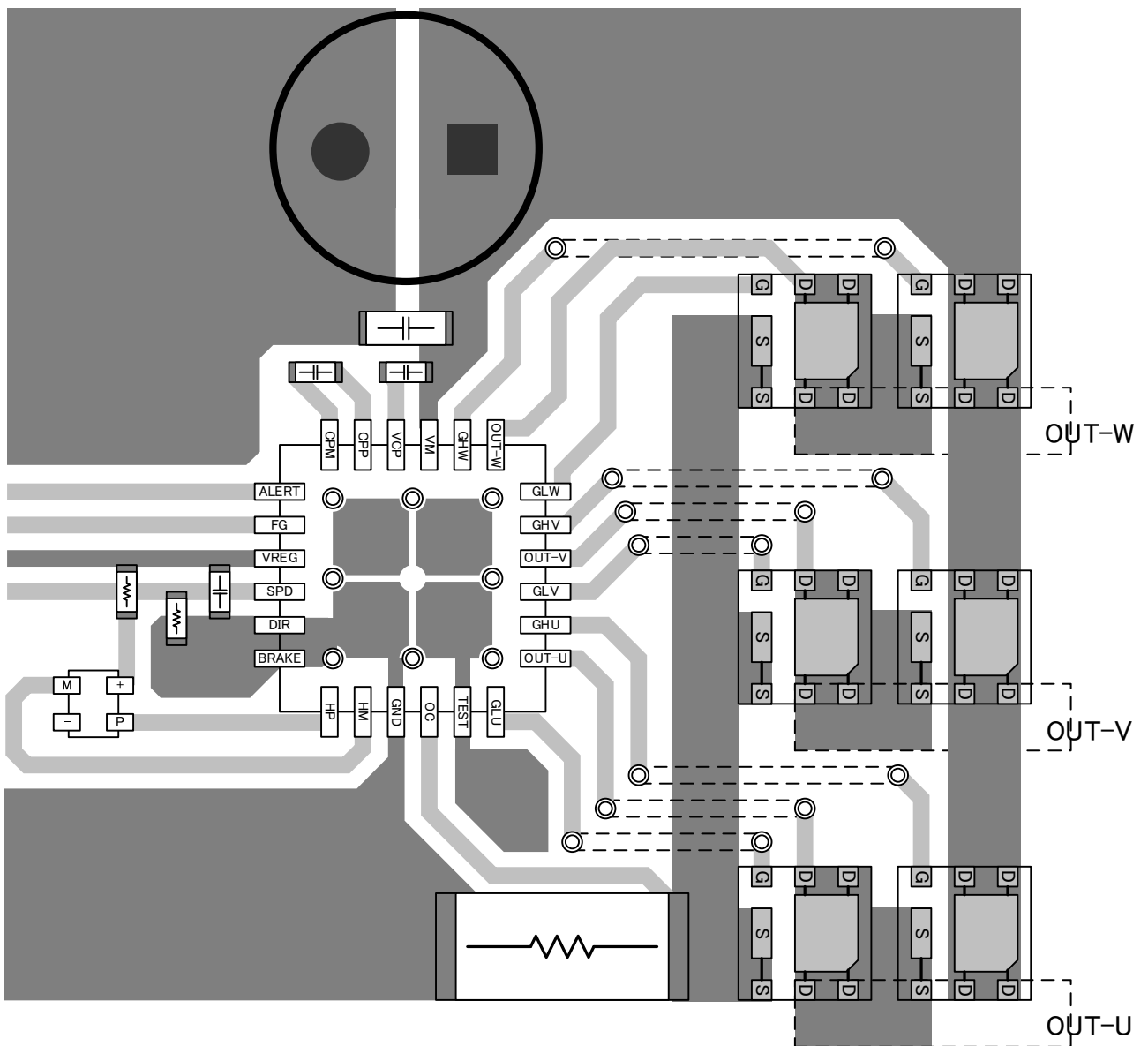

Figure 13.1 Reference board layout

14. Package

14.1. Package dimension

P-VQFN24-0404-0.50-003

Unit: mm

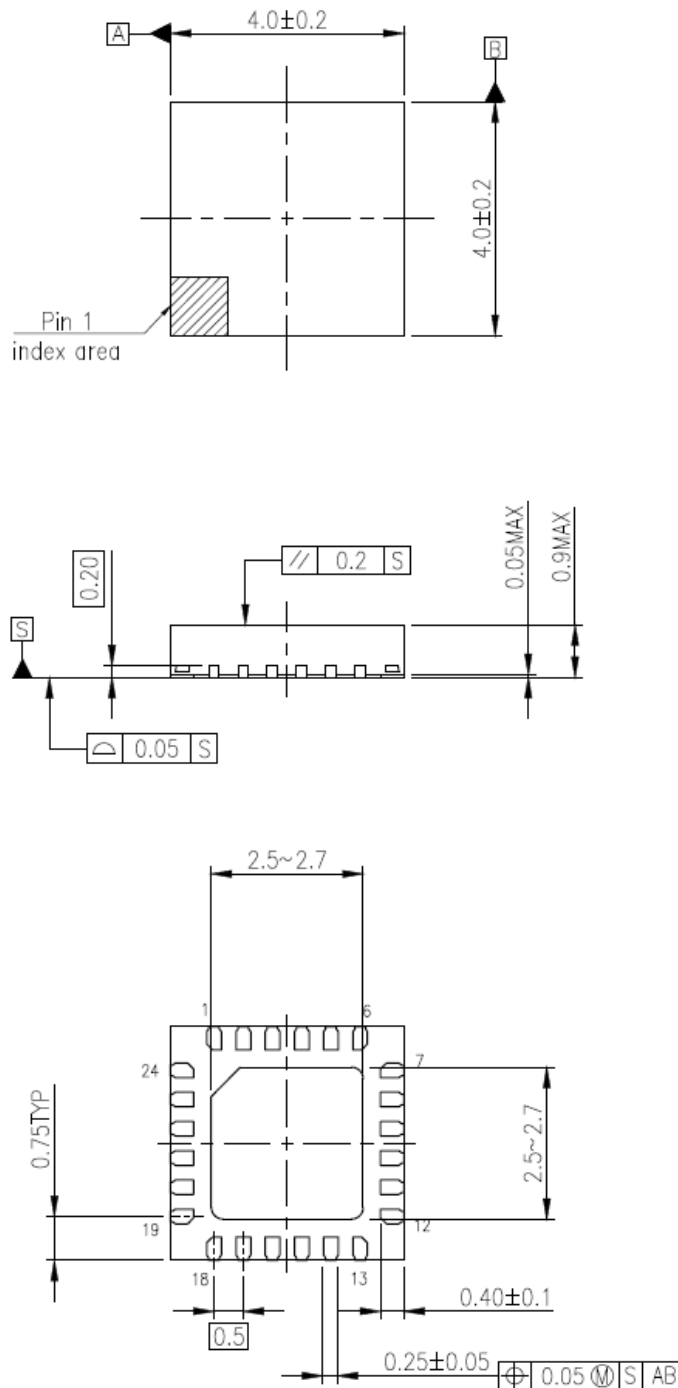

Weight: 0.04 g (typ.)

Figure 14.1 Package dimension

15. IC Usage Considerations

15.1. Notes on handling IC

- [1] The absolute maximum ratings of a semiconductor device are a set of ratings that must not be exceeded, even for a moment. Do not exceed any of these ratings.
Exceeding the rating(s) may cause the device breakdown, damage or deterioration, and may result injury by explosion or combustion.
- [2] Use an appropriate power supply fuse to ensure that a large current does not continuously flow in case of over current and/or IC failure. The IC will fully break down when used under conditions that exceed its absolute maximum ratings, when the wiring is routed improperly or when an abnormal pulse noise occurs from the wiring or load, causing a large current to continuously flow and the breakdown can lead smoke or ignition. To minimize the effects of the flow of a large current in case of breakdown, appropriate settings, such as fuse capacity, fusing time and insertion circuit location, are required.
- [3] If your design includes an inductive load such as a motor coil, incorporate a protection circuit into the design to prevent device malfunction or breakdown caused by the current resulting from the inrush current at power ON or the negative current resulting from the back electromotive force at power OFF. IC breakdown may cause injury, smoke or ignition.
Use a stable power supply with ICs with built-in protection functions. If the power supply is unstable, the protection function may not operate, causing IC breakdown. IC breakdown may cause injury, smoke or ignition.
- [4] Do not insert devices in the wrong orientation or incorrectly.
Make sure that the positive and negative terminals of power supplies are connected properly. Otherwise, the current or power consumption may exceed the absolute maximum rating, and exceeding the rating(s) may cause the device breakdown, damage or deterioration, and may result injury by explosion or combustion.
In addition, do not use any device that is applied the current with inserting in the wrong orientation or incorrectly even just one time.

15.2. Points to remember on handling of ICs

- (1) Over current Protection Circuit
Over current protection circuits (referred to as current limiter circuits) do not necessarily protect ICs under all circumstances. If the over current protection circuits operate against the over current, clear the over current status immediately.
Depending on the method of use and usage conditions, such as exceeding absolute maximum ratings can cause the over current protection circuit to not operate properly or IC breakdown before operation. In addition, depending on the method of use and usage conditions, if over current continues to flow for a long time after operation, the IC may generate heat resulting in breakdown.
- (2) Thermal Shutdown Circuit
Thermal shutdown circuits do not necessarily protect ICs under all circumstances. If the thermal shutdown circuits operate against the over temperature, clear the heat generation status immediately.
Depending on the method of use and usage conditions, such as exceeding absolute maximum ratings can cause the thermal shutdown circuit to not operate properly or IC breakdown before operation.
- (3) Others
Utmost care is necessary in the design of power supply line, GND line, and output line since the IC may be destroyed and occur smoke and fire in some cases by short-circuiting between outputs, to the power supply or ground, or between contiguous pins.

RESTRICTIONS ON PRODUCT USE

Toshiba Corporation and its subsidiaries and affiliates are collectively referred to as "TOSHIBA". Hardware, software and systems described in this document are collectively referred to as "Product".

- TOSHIBA reserves the right to make changes to the information in this document and related Product without notice.
- This document and any information herein may not be reproduced without prior written permission from TOSHIBA. Even with TOSHIBA's written permission, reproduction is permissible only if reproduction is without alteration/omission.
- Though TOSHIBA works continually to improve Product's quality and reliability, Product can malfunction or fail. Customers are responsible for complying with safety standards and for providing adequate designs and safeguards for their hardware, software and systems which minimize risk and avoid situations in which a malfunction or failure of Product could cause loss of human life, bodily injury or damage to property, including data loss or corruption. Before customers use the Product, create designs including the Product, or incorporate the Product into their own applications, customers must also refer to and comply with (a) the latest versions of all relevant TOSHIBA information, including without limitation, this document, the specifications, the data sheets and application notes for Product and the precautions and conditions set forth in the "TOSHIBA Semiconductor Reliability Handbook" and (b) the instructions for the application with which the Product will be used with or for. Customers are solely responsible for all aspects of their own product design or applications, including but not limited to (a) determining the appropriateness of the use of this Product in such design or applications; (b) evaluating and determining the applicability of any information contained in this document, or in charts, diagrams, programs, algorithms, sample application circuits, or any other referenced documents; and (c) validating all operating parameters for such designs and applications. **TOSHIBA ASSUMES NO LIABILITY FOR CUSTOMERS' PRODUCT DESIGN OR APPLICATIONS.**
- **PRODUCT IS NEITHER INTENDED NOR WARRANTED FOR USE IN EQUIPMENTS OR SYSTEMS THAT REQUIRE EXTRAORDINARILY HIGH LEVELS OF QUALITY AND/OR RELIABILITY, AND/OR A MALFUNCTION OR FAILURE OF WHICH MAY CAUSE LOSS OF HUMAN LIFE, BODILY INJURY, SERIOUS PROPERTY DAMAGE AND/OR SERIOUS PUBLIC IMPACT ("UNINTENDED USE").** Except for specific applications as expressly stated in this document, Unintended Use includes, without limitation, equipment used in nuclear facilities, equipment used in the aerospace industry, lifesaving and/or life supporting medical equipment, equipment used for automobiles, trains, ships and other transportation, traffic signaling equipment, equipment used to control combustions or explosions, safety devices, elevators and escalators, and devices related to power plant. **IF YOU USE PRODUCT FOR UNINTENDED USE, TOSHIBA ASSUMES NO LIABILITY FOR PRODUCT.** For details, please contact your TOSHIBA sales representative or contact us via our website.
- Do not disassemble, analyze, reverse-engineer, alter, modify, translate or copy Product, whether in whole or in part.
- Product shall not be used for or incorporated into any products or systems whose manufacture, use, or sale is prohibited under any applicable laws or regulations.
- The information contained herein is presented only as guidance for Product use. No responsibility is assumed by TOSHIBA for any infringement of patents or any other intellectual property rights of third parties that may result from the use of Product. No license to any intellectual property right is granted by this document, whether express or implied, by estoppel or otherwise.
- **ABSENT A WRITTEN SIGNED AGREEMENT, EXCEPT AS PROVIDED IN THE RELEVANT TERMS AND CONDITIONS OF SALE FOR PRODUCT, AND TO THE MAXIMUM EXTENT ALLOWABLE BY LAW, TOSHIBA (1) ASSUMES NO LIABILITY WHATSOEVER, INCLUDING WITHOUT LIMITATION, INDIRECT, CONSEQUENTIAL, SPECIAL, OR INCIDENTAL DAMAGES OR LOSS, INCLUDING WITHOUT LIMITATION, LOSS OF PROFITS, LOSS OF OPPORTUNITIES, BUSINESS INTERRUPTION AND LOSS OF DATA, AND (2) DISCLAIMS ANY AND ALL EXPRESS OR IMPLIED WARRANTIES AND CONDITIONS RELATED TO SALE, USE OF PRODUCT, OR INFORMATION, INCLUDING WARRANTIES OR CONDITIONS OF MERCHANTABILITY, FITNESS FOR A PARTICULAR PURPOSE, ACCURACY OF INFORMATION, OR NONINFRINGEMENT.**
- Do not use or otherwise make available Product or related software or technology for any military purposes, including without limitation, for the design, development, use, stockpiling or manufacturing of nuclear, chemical, or biological weapons or missile technology products (mass destruction weapons). Product and related software and technology may be controlled under the applicable export laws and regulations including, without limitation, the Japanese Foreign Exchange and Foreign Trade Law and the U.S. Export Administration Regulations. Export and re-export of Product or related software or technology are strictly prohibited except in compliance with all applicable export laws and regulations.
- Please contact your TOSHIBA sales representative for details as to environmental matters such as the RoHS compatibility of Product. Please use Product in compliance with all applicable laws and regulations that regulate the inclusion or use of controlled substances, including without limitation, the EU RoHS Directive. **TOSHIBA ASSUMES NO LIABILITY FOR DAMAGES OR LOSSES OCCURRING AS A RESULT OF NONCOMPLIANCE WITH APPLICABLE LAWS AND REGULATIONS.**

X-ON Electronics

Largest Supplier of Electrical and Electronic Components

Click to view similar products for [Motor/Motion/Ignition Controllers & Drivers](#) category:

Click to view products by [Toshiba](#) manufacturer:

Other Similar products are found below :

[FSB50550TB2](#) [FSBF15CH60BTH](#) [MSVCPM2-63-12](#) [MSVGW45-14-2](#) [MSVGW54-14-3](#) [MSVGW54-14-5](#) [NTE7043](#) [LA6565VR-TLM-E](#)
[LB11650-E](#) [LB1837M-TLM-E](#) [LB1845DAZ-XE](#) [LC898300XA-MH](#) [SS30-TE-L-E](#) [26700](#) [LV8281VR-TLM-H](#) [BA5839FP-E2](#) [IRAM236-1067A](#) [LA6584JA-AH](#) [LB11847L-E](#) [NCV70501DW002R2G](#) [AH293-PL-B](#) [TND315S-TL-2H](#) [FNA23060](#) [FSB50250AB](#) [FNA41060](#)
[MSVB54](#) [MSVBTC50E](#) [MSVCPM3-54-12](#) [MSVCPM3-63-12](#) [MSVCPM4-63-12](#) [MSVTA120](#) [FSB50550AB](#) [NCV70501DW002G](#)
[LC898301XA-MH](#) [LV8413GP-TE-L-E](#) [MSVGW45-14-3](#) [MSVGW45-14-4](#) [MSVGW45-14-5](#) [MSVGW54-14-4](#) [STK984-091A-E](#)
[SLA7026M](#) [MP6519GQ-Z](#) [LB11651-E](#) [IRSM515-025DA4](#) [LV8127T-TLM-H](#) [MC33812EKR2](#) [NCP81382MNTXG](#) [TDA21801](#)
[LB11851FA-BH](#) [NCV70627DQ001R2G](#)