

TCK101G, TCK102G

1A Load Switch IC with Slew Rate Control Driver

The TCK101G and TCK102G are load switch ICs for power management with slew rate control driver featuring wide input voltage operation from 1.1 to 5.5 V. Switch ON resistance is only 55 mΩ typical at 3.3 V, 500 mA load condition and these feature a slew rate control driver and thermal shutdown. TCK101G has output auto-discharge function. Maximum Output current type is available up to 1.0A (DC).

This device is available in 0.4 mm pitch ultra small package WCSP6B (0.8 mm x 1.2 mm, t: 0.64 mm (max)). Thus this device is ideal for portable applications that require high-density board assembly such as cellular phone.

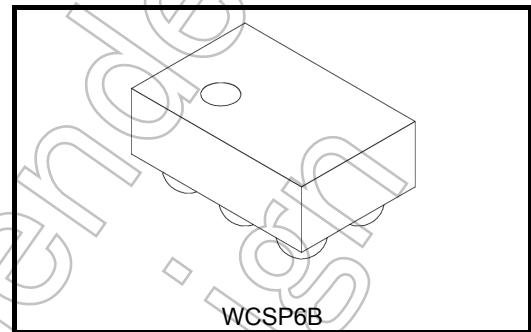

Weight: 1 mg (typ.)

Feature

- Wide input voltage operation: $V_{IN} = 1.1$ to 5.5 V
- Low ON resistance :
 - $R_{ON} = 50$ mΩ (typ.) at $V_{IN} = 5.0$ V, 500 mA
 - $R_{ON} = 55$ mΩ (typ.) at $V_{IN} = 3.3$ V, 500 mA
 - $R_{ON} = 75$ mΩ (typ.) at $V_{IN} = 1.8$ V, 500 mA
 - $R_{ON} = 120$ mΩ (typ.) at $V_{IN} = 1.2$ V, 500 mA
- Low Quiescent Current: $I_Q = 8$ μA (typ.) at $V_{IN} = V_{CT} = 5.5$ V, $I_{OUT} = 0$ mA
- Low standby current: $I_{Q(OFF)} = 0.07$ μA (typ.) at OFF state
- Inrush current reduction circuit
- Thermal Shutdown function
- Auto-discharge (TCK101G)
- Pull down connection between CONTROL and GND
- Ultra small package : WCSP6B (0.8mm x 1.2mm, t: 0.64mm(max))

Absolute Maximum Ratings (Ta = 25°C)

Characteristics	Symbol	Rating	Unit
Input voltage	V_{IN}	-0.3 to 6.0	V
Control voltage	V_{CT}	-0.3 to 6.0	V
Output voltage	V_{OUT}	-0.3 to $V_{IN} + 0.3$	V
Output current	I_{OUT}	DC 1.0	A
Power dissipation	P_D	800 (Note 1)	mW
Operating temperature range	T_{opr}	-40 to 85	°C
Junction temperature	T_j	150	°C
Storage temperature	T_{stg}	-55 to 150	°C

Note : Using continuously under heavy loads (e.g. the application of high temperature/current/voltage and the significant change in temperature, etc.) may cause this product to decrease in the reliability significantly even if the operating conditions (i.e. operating temperature/current/voltage, etc.) are within the absolute maximum ratings and the operating ranges. Please design the appropriate reliability upon reviewing the Toshiba Semiconductor Reliability Handbook ("Handling Precautions"/"Derating Concept and Methods") and individual reliability data (i.e. reliability test report and estimated failure rate, etc).

Note1: Rating at mounting on a board

(Glass epoxy board dimension : 40mm x 40mm, both sides of board

Metal pattern ratio : a surface approximately 50%, the reverse side approximately 50%

Through hole: diameter 0.5mm x 28)

Pin Assignment(Top view)

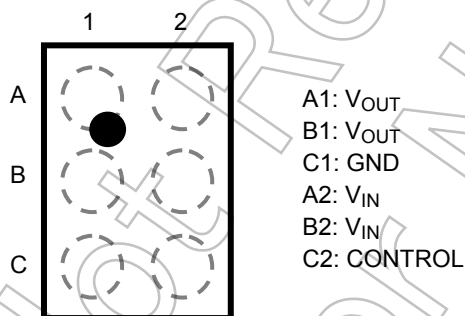

Top marking

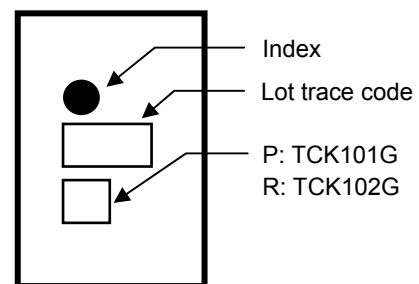

Block Diagram

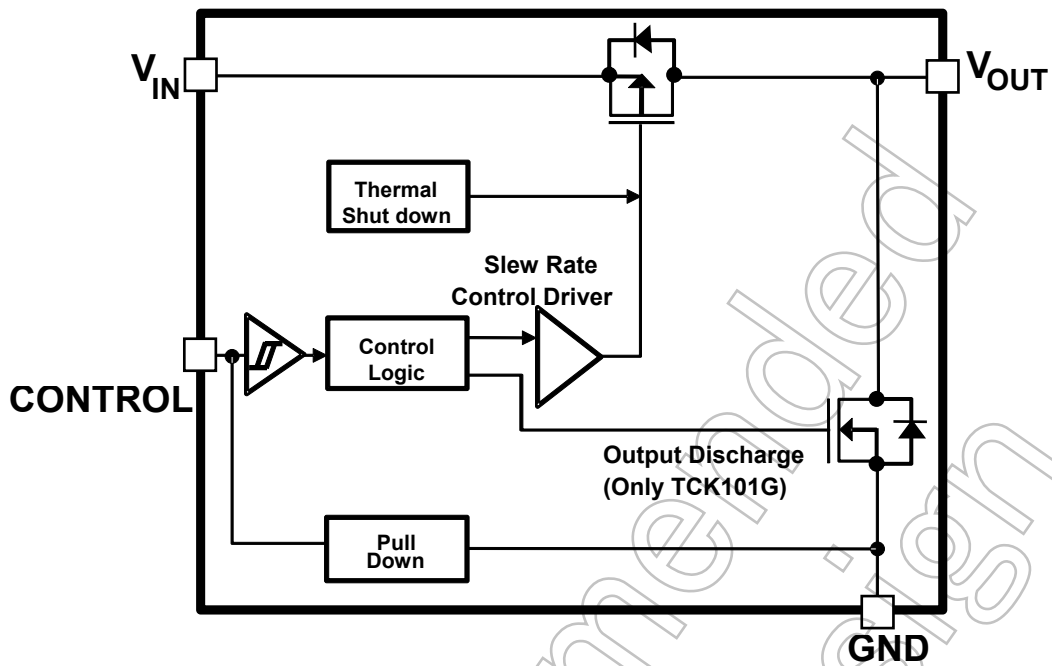

Function Table

Part number	Function		
	Thermal Shutdown	Output auto-discharge	Control pin connection
TCK101G	Built in	Built in	Pull down
TCK102G	Built in		Pull down

Electrical Characteristics

DC Characteristics (Ta = -40 to 85°C)

Characteristics	Symbol	Test Condition	Ta = 25°C			Ta = -40 to 85°C		Unit	
			Min	Typ.	Max	Min	Max		
Input voltage	V_{IN}	—	1.1	—	5.5	1.1	5.5	V	
CONTROL High-level input voltage	V_{IH}	$1.2\text{ V} < V_{IN} \leq 5.5\text{ V}$	1.0	—	—	1.0	—	V	
		$1.1\text{ V} \leq V_{IN} \leq 1.2\text{ V}$	0.9	—	—	0.9	—	V	
CONTROL Low-level input voltage	V_{IL}	$V_{IN} = 1.1\text{ to }5.5\text{ V}$	—	—	0.4	—	0.4	V	
Quiescent current (ON state)	I_Q	$I_{OUT} = 0\text{ mA}$, $V_{IN} = V_{CT} = 5.5\text{ V}$	—	8	—	—	20	μA	
Standby current (OFF state)	$I_{Q(OFF)}$	$V_{IN} = 5.5\text{ V}$, $V_{CT} = 0\text{ V}$, $V_{OUT} = \text{OPEN}$ (Note 2)	—	0.07	—	—	1	μA	
OFF-state switch current	$I_{SD(OFF)}$	$V_{CT} = 0\text{ V}$, $V_{OUT} = \text{GND}$	$V_{IN} = 5.0\text{ V}$	—	10	—	—	1000 (Note3)	nA
			$V_{IN} = 3.3\text{ V}$	—	2	—	—	1000	
			$V_{IN} = 1.8\text{ V}$	—	1	—	—	1000	
			$V_{IN} = 1.2\text{ V}$	—	1	—	—	1000	
On resistance	R_{ON}	$I_{OUT} = 500\text{ mA}$	$V_{IN} = 5.0\text{ V}$	—	50	—	—	70	m Ω
			$V_{IN} = 3.3\text{ V}$	—	55	—	—	75	
			$V_{IN} = 1.8\text{ V}$	—	75	—	—	100	
			$V_{IN} = 1.2\text{ V}$	—	120	—	—	180	
			$V_{IN} = 1.1\text{ V}$	—	155	—	—	—	
Discharge on resistance	R_{SD}	— (TCK101G)	—	100	—	—	—	Ω	

Note 2 : Except OFF-state switch current

Note 3 : Ta = 65 °C

AC Characteristics (Ta = 25°C)

V_{IN} = 1.2 V

Characteristics	Symbol	Test Condition(Figure 1)	Min	Typ.	Max	Unit	
V _{OUT} rise time	t _r	R _L = 500 Ω , C _L = 0.1 μF	—	370	—	μs	
V _{OUT} fall time	t _f	R _L = 500 Ω , C _L = 0.1 μF	TCK101G	—	25	—	μs
			TCK102G	—	95	—	
Turn on delay	t _{ON}	R _L = 500 Ω , C _L = 0.1 μF	—	390	—	μs	
Turn off delay	t _{OFF}	R _L = 500 Ω , C _L = 0.1 μF	—	8	—	μs	

V_{IN} = 3.3 V

Characteristics	Symbol	Test Condition(Figure 1)	Min	Typ.	Max	Unit	
V _{OUT} rise time	t _r	R _L = 500 Ω , C _L = 0.1 μF	—	170	—	μs	
V _{OUT} fall time	t _f	R _L = 500 Ω , C _L = 0.1 μF	TCK101G	—	45	—	μs
			TCK102G	—	100	—	
Turn on delay	t _{ON}	R _L = 500 Ω , C _L = 0.1 μF	—	135	—	μs	
Turn off delay	t _{OFF}	R _L = 500 Ω , C _L = 0.1 μF	—	10	—	μs	

AC Waveform

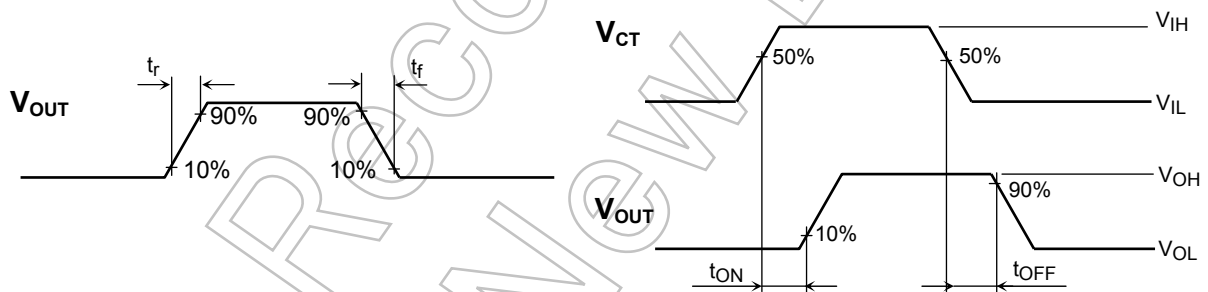
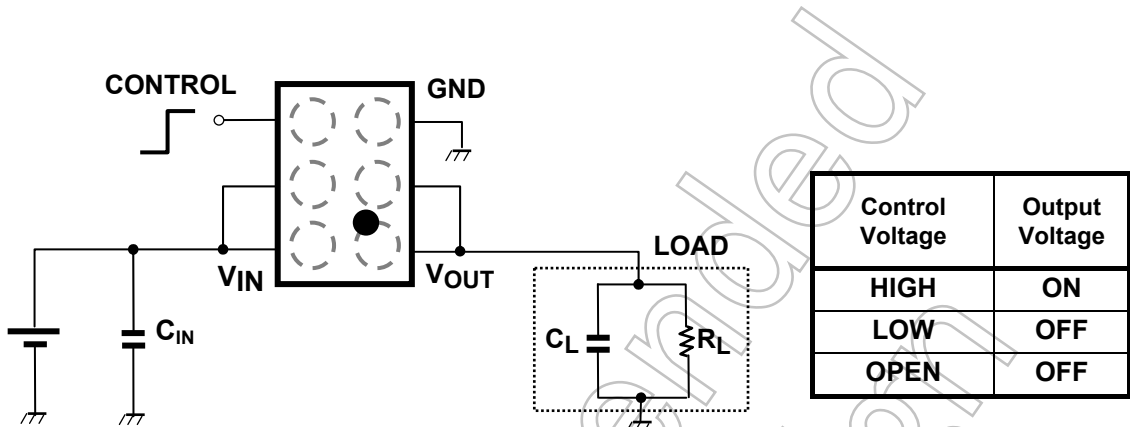

Figure 1 t_r, t_f, t_{ON}, t_{OFF} Waveforms

Application Note

1. Application circuit example (top view)

The figure below shows the recommended configuration for TCK101G and TCK102G.



1) Input capacitor C_{IN}

An input capacitor (C_{IN}) is not necessary for the guaranteed operation of TCK101G and TCK102G. However, it is recommended to use input capacitors to reduce voltage drop due to sharp changes in output current and also for improved stability of the power supply. When used, place C_{IN} as close to V_{IN} pin to improve stability of the power supply. Also, due to the C_{IN} selected, $V_{IN} < V_{OUT}$ may occur, causing a reverse current to flow through the body diode of the pass-through p-ch MOSFET of the load switch IC. In this case, a higher value for C_{IN} as compared to C_L is recommended.

2) Output capacitor

An output capacitor (C_{OUT}) is not necessary for the guaranteed operation of TCK101G and TCK102G. However, there is a possibility of overshoot or undershoot caused by output load transient response, board layout and parasitic components of load switch IC. In this case, an output capacitor with C_{OUT} more than $0.1\mu F$ is recommended.

3) Control pin

A control pins for TCK101G and TCK102G are both Active High, which controls both the pass-through p-ch MOSFET and the discharge n-ch MOSFET (only for TCK101G), operated by the control voltage and Schmitt trigger. When the control voltage level is High, p-ch MOSFET is ON state and n-ch MOSFET is OFF state. When control voltage level is Low, and the state of the MOSFETs is reversed. Also, pull down resistance equivalent to a few $M\Omega$ is connected between CONTROL and GND, thus the load switch IC is in OFF state even when CONTROL pin is OPEN. In addition, CONTROL pin has a tolerant function such that it can be used even if the control voltage is higher than the input voltage.

2. Power Dissipation

Power dissipation is measured on the board condition shown below.

[The Board Condition]

Board material: Glass epoxy (FR4)

Board dimension: 40mm x 40mm (both sides of board), t=1.8mm

Metal pattern ratio: a surface approximately 50%, the reverse side approximately 50%

Through hole: diameter 0.5mm x 28

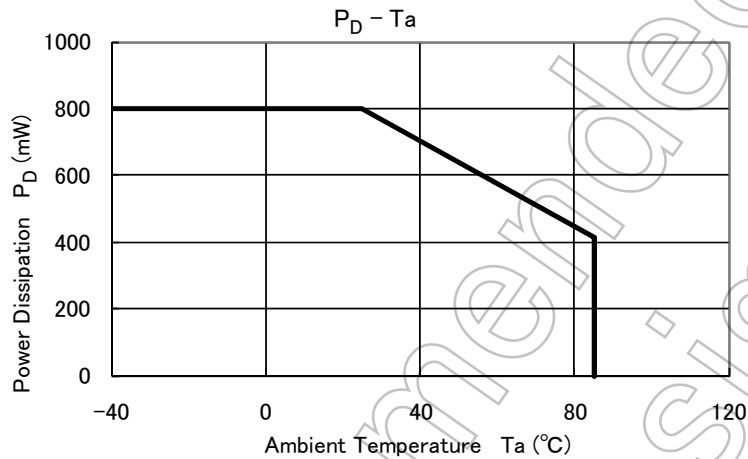

Please allow sufficient margin when designing a board pattern to fit the expected power dissipation. Also take into consideration the ambient temperature, input voltage, output current etc and applying the appropriate derating for allowable power dissipation during operation.

3. Thermal shut down function

Thermal shutdown function is designed in these products, but these does not assure for the suppression of uprising device operation. In use of these products, please read through and understand dissipation idea for absolute maximum ratings from the above mention or our 'Semiconductor Reliability Handbook'. Then use these products under absolute maximum ratings in any condition. Furthermore, Toshiba recommend inserting failsafe system into the design.

TCK101G, TCK102G Representative Characteristics

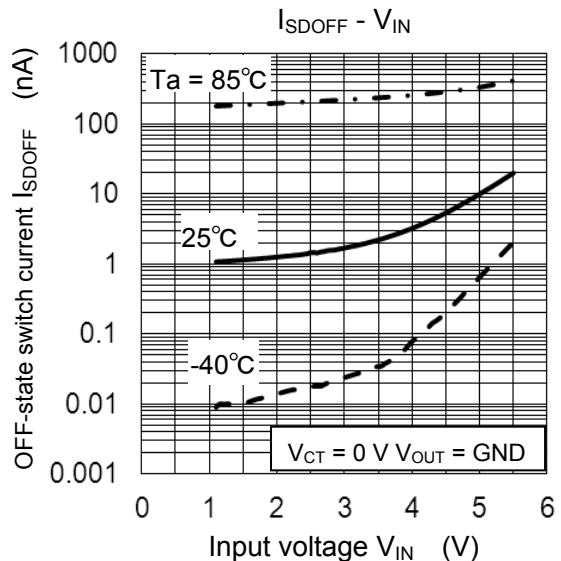
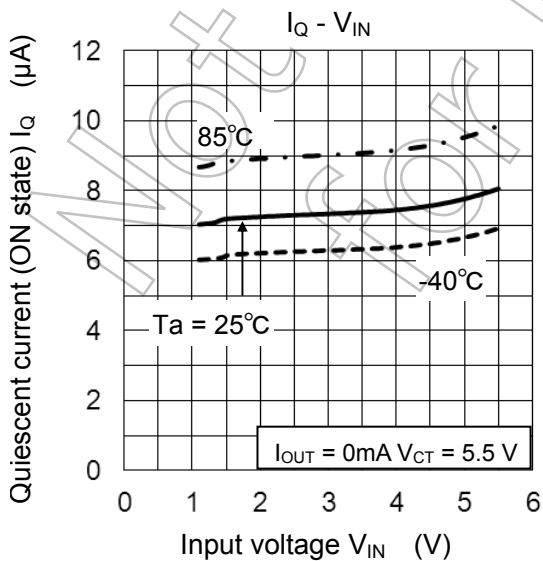
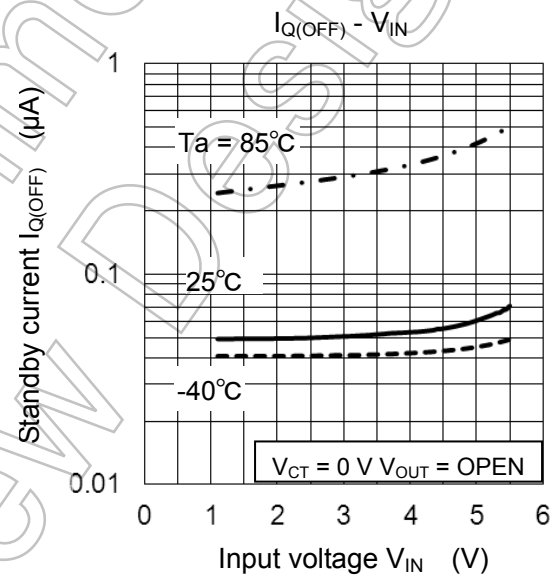
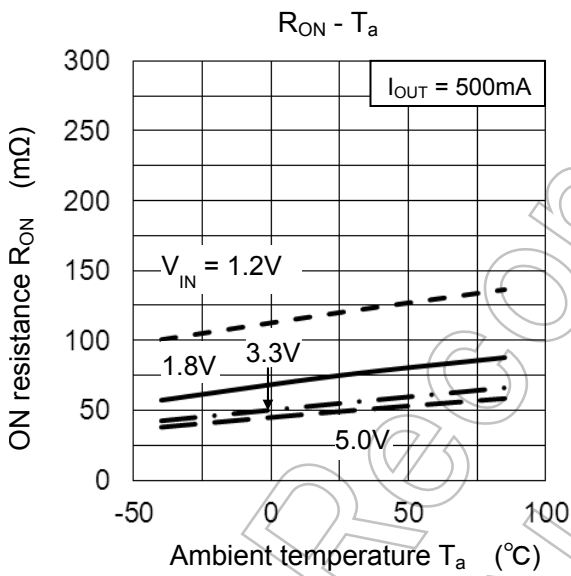
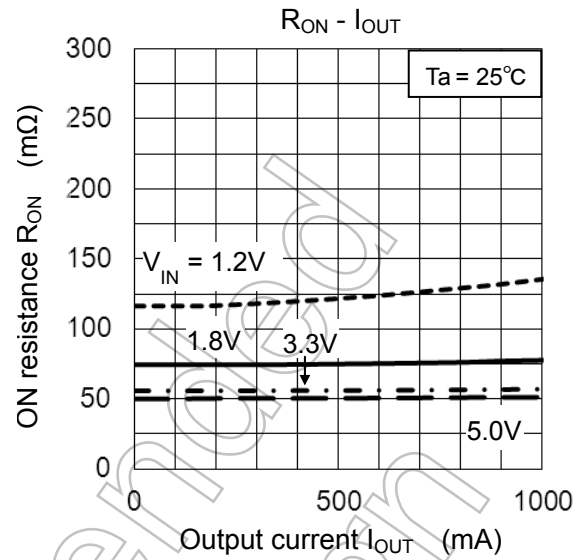
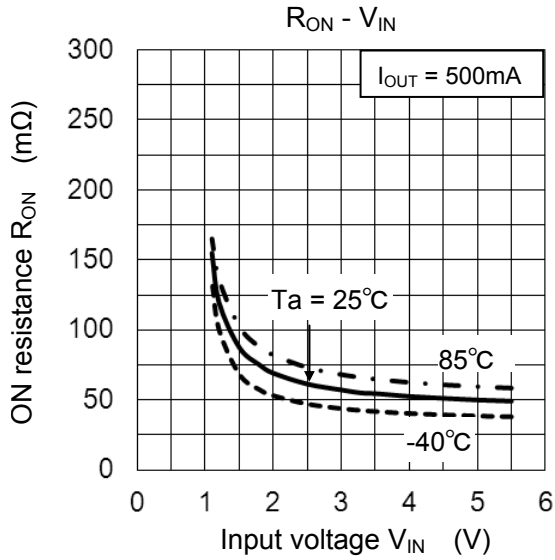

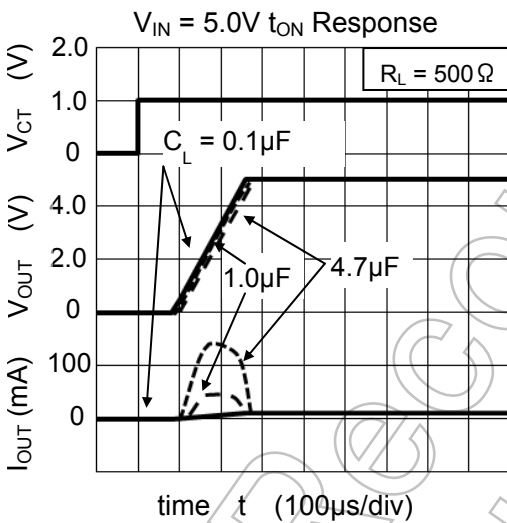
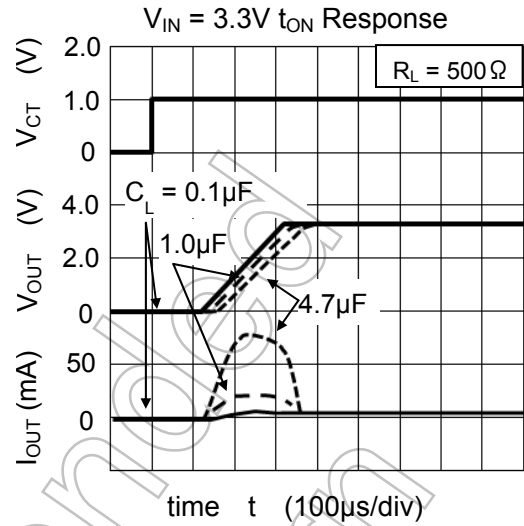
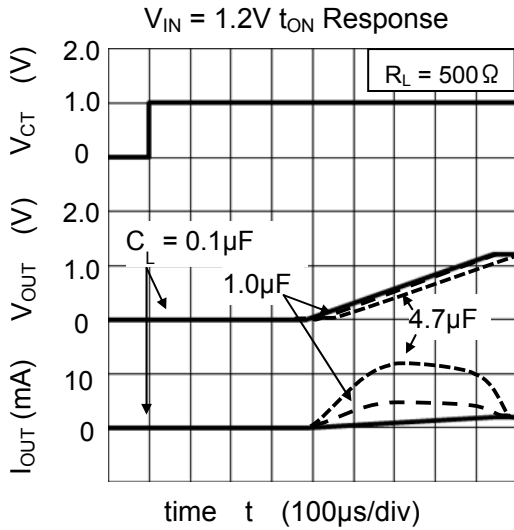

TCK101G t_{OFF} Response

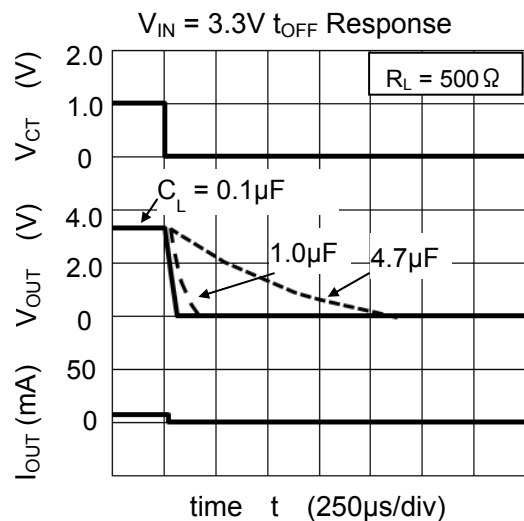
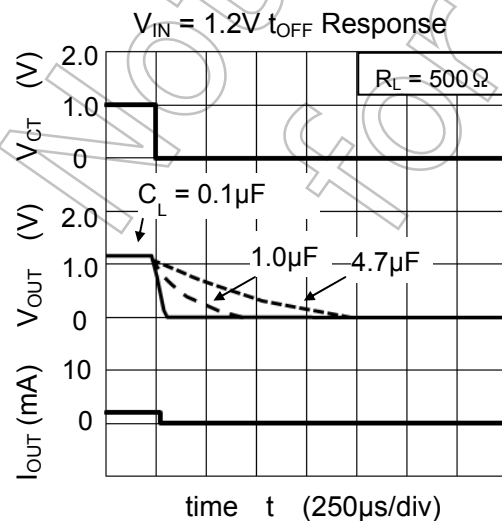

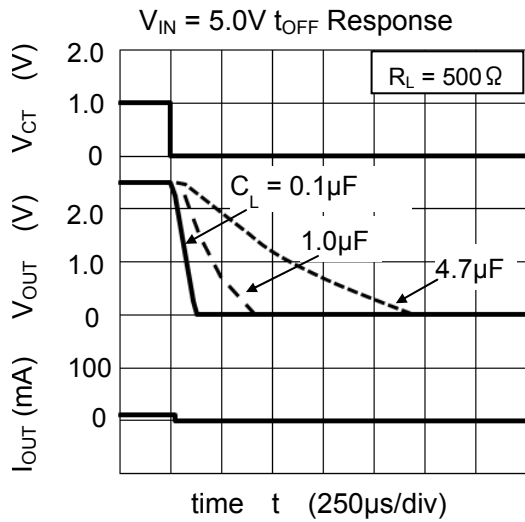

TCK102G t_{OFF} Response

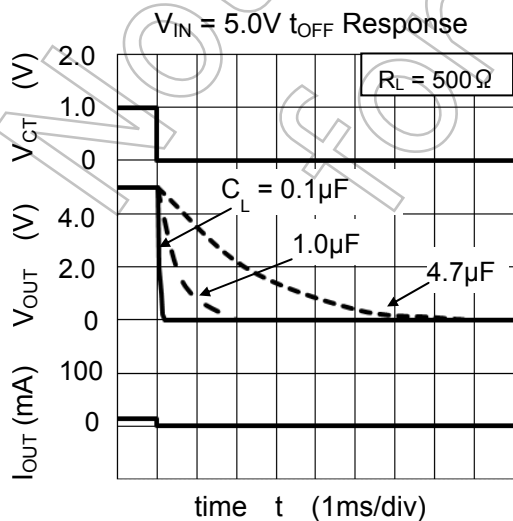
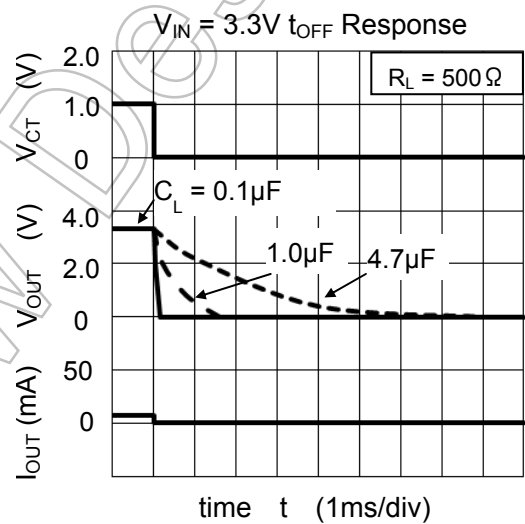
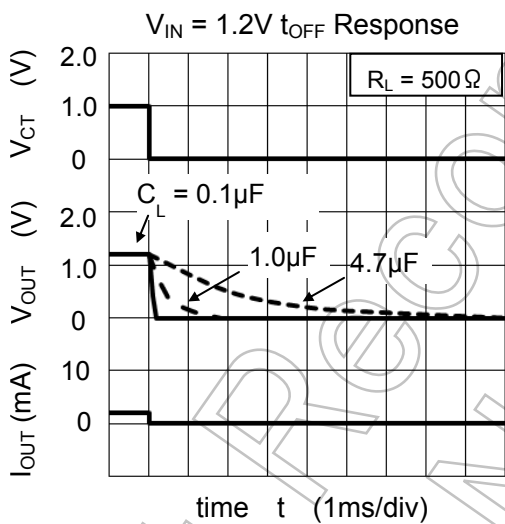

Package dimension

Unit: mm

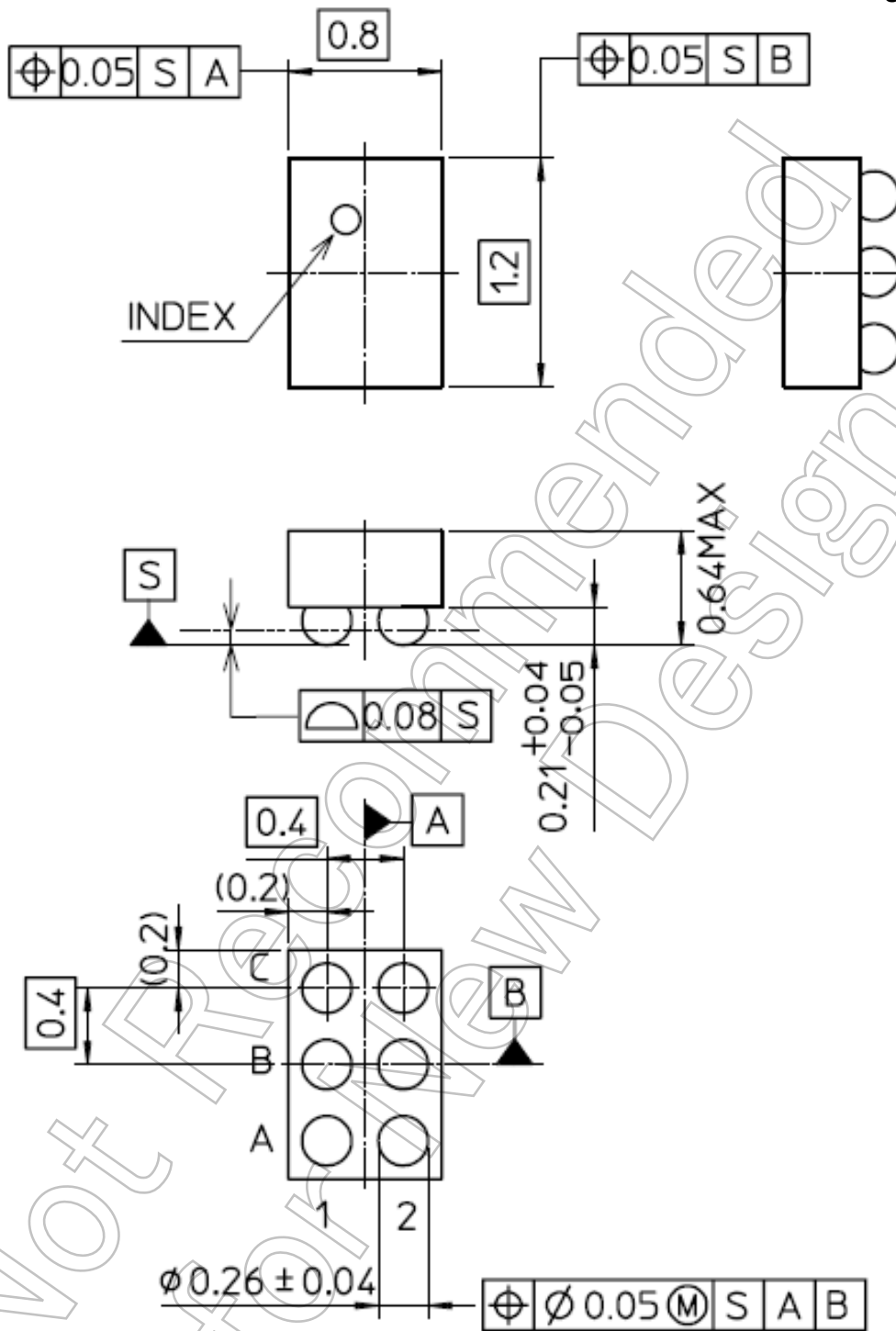

Weight: 1 mg (typ.)

RESTRICTIONS ON PRODUCT USE

- Toshiba Corporation, and its subsidiaries and affiliates (collectively "TOSHIBA"), reserve the right to make changes to the information in this document, and related hardware, software and systems (collectively "Product") without notice.
- This document and any information herein may not be reproduced without prior written permission from TOSHIBA. Even with TOSHIBA's written permission, reproduction is permissible only if reproduction is without alteration/omission.
- Though TOSHIBA works continually to improve Product's quality and reliability, Product can malfunction or fail. Customers are responsible for complying with safety standards and for providing adequate designs and safeguards for their hardware, software and systems which minimize risk and avoid situations in which a malfunction or failure of Product could cause loss of human life, bodily injury or damage to property, including data loss or corruption. Before customers use the Product, create designs including the Product, or incorporate the Product into their own applications, customers must also refer to and comply with (a) the latest versions of all relevant TOSHIBA information, including without limitation, this document, the specifications, the data sheets and application notes for Product and the precautions and conditions set forth in the "TOSHIBA Semiconductor Reliability Handbook" and (b) the instructions for the application with which the Product will be used with or for. Customers are solely responsible for all aspects of their own product design or applications, including but not limited to (a) determining the appropriateness of the use of this Product in such design or applications; (b) evaluating and determining the applicability of any information contained in this document, or in charts, diagrams, programs, algorithms, sample application circuits, or any other referenced documents; and (c) validating all operating parameters for such designs and applications. **TOSHIBA ASSUMES NO LIABILITY FOR CUSTOMERS' PRODUCT DESIGN OR APPLICATIONS.**
- **PRODUCT IS NEITHER INTENDED NOR WARRANTED FOR USE IN EQUIPMENTS OR SYSTEMS THAT REQUIRE EXTRAORDINARILY HIGH LEVELS OF QUALITY AND/OR RELIABILITY, AND/OR A MALFUNCTION OR FAILURE OF WHICH MAY CAUSE LOSS OF HUMAN LIFE, BODILY INJURY, SERIOUS PROPERTY DAMAGE AND/OR SERIOUS PUBLIC IMPACT ("UNINTENDED USE").** Except for specific applications as expressly stated in this document, Unintended Use includes, without limitation, equipment used in nuclear facilities, equipment used in the aerospace industry, medical equipment, equipment used for automobiles, trains, ships and other transportation, traffic signaling equipment, equipment used to control combustions or explosions, safety devices, elevators and escalators, devices related to electric power, and equipment used in finance-related fields. **IF YOU USE PRODUCT FOR UNINTENDED USE, TOSHIBA ASSUMES NO LIABILITY FOR PRODUCT.** For details, please contact your TOSHIBA sales representative.
- Do not disassemble, analyze, reverse-engineer, alter, modify, translate or copy Product, whether in whole or in part.
- Product shall not be used for or incorporated into any products or systems whose manufacture, use, or sale is prohibited under any applicable laws or regulations.
- The information contained herein is presented only as guidance for Product use. No responsibility is assumed by TOSHIBA for any infringement of patents or any other intellectual property rights of third parties that may result from the use of Product. No license to any intellectual property right is granted by this document, whether express or implied, by estoppel or otherwise.
- **ABSENT A WRITTEN SIGNED AGREEMENT, EXCEPT AS PROVIDED IN THE RELEVANT TERMS AND CONDITIONS OF SALE FOR PRODUCT, AND TO THE MAXIMUM EXTENT ALLOWABLE BY LAW, TOSHIBA (1) ASSUMES NO LIABILITY WHATSOEVER, INCLUDING WITHOUT LIMITATION, INDIRECT, CONSEQUENTIAL, SPECIAL, OR INCIDENTAL DAMAGES OR LOSS, INCLUDING WITHOUT LIMITATION, LOSS OF PROFITS, LOSS OF OPPORTUNITIES, BUSINESS INTERRUPTION AND LOSS OF DATA, AND (2) DISCLAIMS ANY AND ALL EXPRESS OR IMPLIED WARRANTIES AND CONDITIONS RELATED TO SALE, USE OF PRODUCT, OR INFORMATION, INCLUDING WARRANTIES OR CONDITIONS OF MERCHANTABILITY, FITNESS FOR A PARTICULAR PURPOSE, ACCURACY OF INFORMATION, OR NONINFRINGEMENT.**
- Do not use or otherwise make available Product or related software or technology for any military purposes, including without limitation, for the design, development, use, stockpiling or manufacturing of nuclear, chemical, or biological weapons or missile technology products (mass destruction weapons). Product and related software and technology may be controlled under the applicable export laws and regulations including, without limitation, the Japanese Foreign Exchange and Foreign Trade Law and the U.S. Export Administration Regulations. Export and re-export of Product or related software or technology are strictly prohibited except in compliance with all applicable export laws and regulations.
- Please contact your TOSHIBA sales representative for details as to environmental matters such as the RoHS compatibility of Product. Please use Product in compliance with all applicable laws and regulations that regulate the inclusion or use of controlled substances, including without limitation, the EU RoHS Directive. **TOSHIBA ASSUMES NO LIABILITY FOR DAMAGES OR LOSSES OCCURRING AS A RESULT OF NONCOMPLIANCE WITH APPLICABLE LAWS AND REGULATIONS.**

X-ON Electronics

Largest Supplier of Electrical and Electronic Components

Click to view similar products for [Power Switch ICs - Power Distribution](#) category:

Click to view products by [Toshiba](#) manufacturer:

Other Similar products are found below :

[TCK111G,LF\(S\)](#) [FPF1018](#) [DS1222](#) [TCK2065G,LF](#) [SZNCP3712ASNT3G](#) [MIC2033-05BYMT-T5](#) [MIC2033-12AYMT-T5](#) [MIC2033-05BYM6-T5](#) [SLG5NT1437VTR](#) [SZNCP3712ASNT1G](#) [DML1008LDS-7](#) [KTS1670EDA-TR](#) [KTS1640QGDV-TR](#) [KTS1641QGDV-TR](#) [NCV459MNWTBG](#) [FPF2260ATMX](#) [U6513A](#) [MIC2012YM-TR](#) [NCP45780IMN24RTWG](#) [MAX14919ATP+](#) [MC33882PEP](#) [TPS2104DBVR](#) [MIC2098-1YMT-TR](#) [MIC94062YMT TR](#) [MP6231DN-LF](#) [MIC2075-2YM](#) [MIC94068YML-TR](#) [SIP32461DB-T2-GE1](#) [NCP335FCT2G](#) [TCK105G,LF\(S\)](#) [AP2411S-13](#) [AP2191DWG-7](#) [AP2151DSG-13](#) [MIC94094YC6-TR](#) [MIC94093YC6-TR](#) [MIC94064YC6-TR](#) [MIC2505-1YM](#) [MIC94305YMT-TR](#) [MIC94085YFT-TR](#) [MIC94081YFT-TR](#) [MIC94042YFL-TR](#) [MIC94041YFL-TR](#) [MIC2005-1.2YM6-TR](#) [TPS2032QDRQ1](#) [NCP333FCT2G](#) [BTS3050TFATMA1](#) [NCP331SNT1G](#) [TPS2092DR](#) [TPS2063DR](#) [TPS2042P](#)