

TOSHIBA CMOS Linear Integrated Circuit Silicon Monolithic

TCK2291xG

2A Load Switch IC with True Reverse Current Blocking

The TCK2291xG series is Load Switch ICs for power management with True Reverse Current Blocking and Thermal Shutdown function featuring low switch on resistance, ultra low quiescent current, high output current and wide input operating voltage range of 1.1 to 5.5 V. Switch ON resistance is only 31 m Ω at 5.0 V, -0.15 A load conditions and output current is available on 2.0 A. And these feature a slew rate control driver and output auto-discharge function.

These devices are available in 0.4 mm pitch ultra small package WCSP6E (0.8 mm x 1.2 mm, t: 0.55 mm). Thus these devices are ideal for portable applications that require high-density board assembly such as cellular phone.

Feature

- True Reverse Current Blocking
- Thermal Shutdown function
- Output auto-discharge (Option)
- Under voltage lockout
- Low ON resistance :
 - RON = 31 m Ω (typ.) at VIN = 5.0 V, IOUT = -0.15 A
 - RON = 40 m Ω (typ.) at VIN = 3.3 V, IOUT = -0.15 A
 - RON = 70 m Ω (typ.) at VIN = 1.8 V, IOUT = -0.15 A
 - RON = 141 m Ω (typ.) at VIN = 1.2 V, IOUT = -0.15 A
- Low Quiescent Current: IQ = 11 μ A (typ.) at IOUT = 0 mA
- Low standby current: IQ(OFF) = 0.6 μ A (typ.) at OFF state
- Inrush current reduction circuit
- Pull down connection between Control and GND(Option)
- Ultra small package : WCSP6E (0.8 mm x 1.2 mm, t: 0.55 mm)

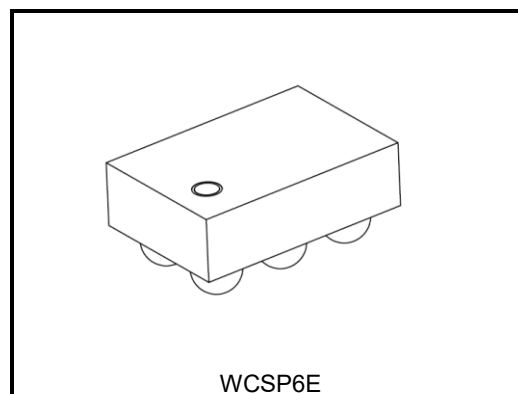

Weight: 1 mg (typ.)

Start of commercial production
2016-06

Function Table

Part number	Function						Device Marking
	True Reverse current blocking	Output auto-discharge	Under voltage lock out	Thermal shutdown	Control pin polarity	Control pin pull down connection	
TCK22910G	Built in	N/A	Built in	Built in	Active Low	N/A	4S
TCK22911G	Built in	Built in	Built in	Built in	Active Low	N/A	3S
TCK22912G	Built in	N/A	Built in	Built in	Active High	Built in	2S
TCK22913G	Built in	Built in	Built in	Built in	Active High	Built in	1S

Absolute Maximum Ratings (Ta = 25°C)

Characteristics	Symbol	Rating		Unit
Input voltage	V _{IN}	-0.3 to 6.0		V
Control voltage	V _{CT}	-0.3 to 6.0		V
Output voltage	V _{OUT}	-0.3 to 6.0		V
Output current	I _{OUT}	DC	2.0	A
		Pulse	3.0 (Note1)	A
Power dissipation	P _D	800 (Note 2)		mW
Operating temperature range	T _{opr}	-40 to 85		°C
Junction temperature	T _j	150		°C
Storage temperature	T _{stg}	-55 to 150		°C

Note : Using continuously under heavy loads (e.g. the application of high temperature/current/voltage and the significant change in temperature, etc.) may cause this product to decrease in the reliability significantly even if the operating conditions (i.e. operating temperature/current/voltage, etc.) are within the absolute maximum ratings. Please design the appropriate reliability upon reviewing the Toshiba Semiconductor Reliability Handbook (“Handling Precautions”/“Derating Concept and Methods”) and individual reliability data (i.e. reliability test report and estimated failure rate, etc).

Note1: 100 μs pulse, 2% duty cycle

Note2: Rating at mounting on a board

Glass epoxy board dimension : 40mm x 40mm (both sides of board), t=1.6mm

Metal pattern ratio : a surface approximately 50%, the reverse side approximately 50%

Through hole : diameter 0.5mm x 28)

Operating conditions

Characteristics	Symbol	Condition	Min	Max	Unit
Input voltage	V _{IN}	—	1.1	5.5	V
Output voltage	V _{OUT}	—	—	V _{IN}	V
Output current	I _{OUT}	1.8 V ≤ V _{IN}	—	2.0	A
Control High-level input voltage	V _{IH}	1.2V < V _{IN} ≤ 5.5 V	1.0	—	V
		1.1V ≤ V _{IN} ≤ 1.2 V	0.9	—	V
Control Low-level input voltage	V _{IL}	—	—	0.4	V

Pin Assignment(Top view)

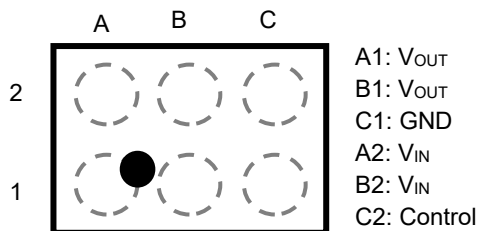

Top marking

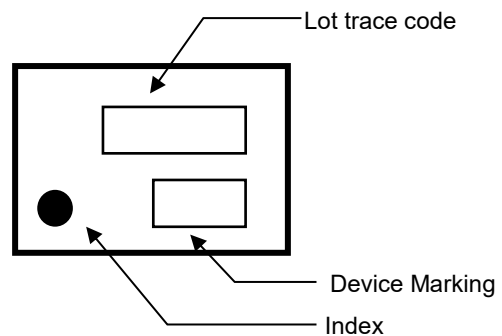

Block Diagram

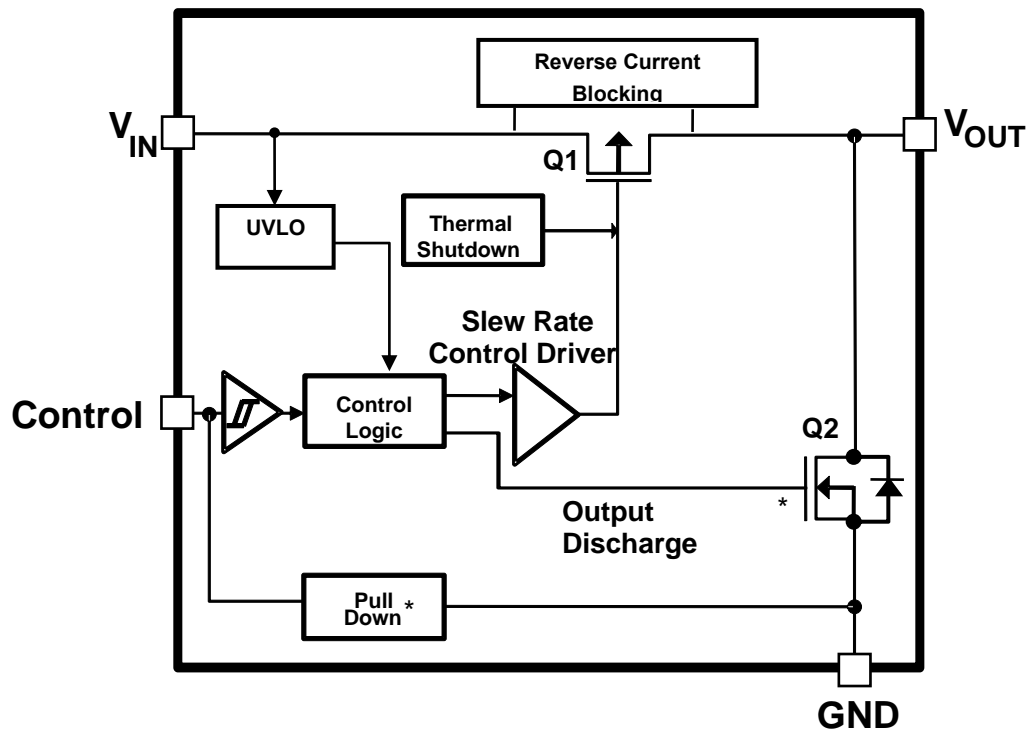

*:Option

Operation logic table

		TCK22910G	TCK22911G	TCK22912G	TCK22913G
Control "High"	Output Q ₁	OFF	OFF	ON	ON
	Discharge Q ₂	—	ON	—	OFF
	Reverse current blocking	Active	Active	Active	Active
Control "Low"	Output Q ₁	ON	ON	OFF	OFF
	Discharge Q ₂	—	OFF	—	ON
	Reverse current blocking	Active	Active	Active	Active

Electrical Characteristics

DC Characteristics (Ta = -40 to 85°C)

Characteristics	Symbol	Test Condition		Ta = 25°C			Ta = -40 to 85°C		Unit
				Min	Typ.	Max	Min	Max	
Quiescent current (ON state)	IQ	I _{OUT} = 0 mA	V _{IN} = 1.1 V	—	9	—	—	—	μA
			V _{IN} = 5.5 V	—	11	—	—	20	μA
Quiescent current (OFF state)	I _{Q(OFF)}	V _{IN} = 5.5 V, V _{OUT} = OPEN, (Note 3)		—	0.6	—	—	2.5	μA
Switch leakage current(OFF state)	I _{SD(OFF)}	V _{OUT} = GND, current through from V _{IN} to V _{OUT} . (Note 4)	V _{IN} = V _{CT} = 5.5 V	—	20	—	—	2000	nA
Reverse blocking current	I _{RB}	V _{OUT} = 5.0 V, V _{IN} = 0 V, RCB active		—	0.01	—	—	2	μA
Reverse blocking voltage threshold	V _{RB}	V _{OUT} – V _{IN}		—	35	—	—	—	mV
Reverse blocking release voltage threshold	V _{RBR}	V _{OUT} – V _{IN}		—	-15	—	—	—	mV
Under Voltage Lock Out (UVLO) rising threshold	V _{UVL_RI}	—		—	0.82	—	—	1.1	V
Under Voltage Lock Out (UVLO) falling threshold	V _{UVL_FA}	—		—	0.77	—	—	—	V
On resistance	R _{ON}	I _{OUT} = -0.15 A	V _{IN} = 5.0 V	—	31	—	—	85	mΩ
			V _{IN} = 3.3 V	—	40	—	—	95	
			V _{IN} = 1.8 V	—	70	—	—	140	
			V _{IN} = 1.2 V	—	141	—	—	—	
Output discharge on resistance	R _{SD}	— (Note 5)		—	100	—	—	—	Ω

Note 3 : Except I_{SD(OFF)} OFF-state switch current

Note 4 : Only applies to the TCK22910G and TCK22912G

Note 5 : Only applies to the TCK22911G and TCK22913G

AC Characteristics (Ta = 25°C)

V_{IN} = 5.0 V, TCK22910G

Characteristics	Symbol	Test Condition(Figure 2)	Min	Typ.	Max	Unit
V _{OUT} rise time	t _r	V _{IN} = 5.0 V , R _L = 500 Ω , C _L =0.1 μF,	—	1.4	—	ms
V _{OUT} fall time	t _f	V _{IN} = 5.0 V , R _L = 500 Ω , C _L =0.1 μF,	—	120	—	μs
Turn on delay	t _{ON}	V _{IN} = 5.0 V , R _L = 500 Ω , C _L =0.1 μF,	—	800	—	μs
Turn off delay	t _{OFF}	V _{IN} = 5.0 V , R _L = 500 Ω , C _L =0.1 μF,	—	5	—	μs

V_{IN} = 5.0 V, TCK22911G

Characteristics	Symbol	Test Condition(Figure 2)	Min	Typ.	Max	Unit
V _{OUT} rise time	t _r	V _{IN} = 5.0 V , R _L = 500 Ω , C _L =0.1 μF,	—	1.4	—	ms
V _{OUT} fall time	t _f	V _{IN} = 5.0 V , R _L = 500 Ω , C _L =0.1 μF,	—	60	—	μs
Turn on delay	t _{ON}	V _{IN} = 5.0 V , R _L = 500 Ω , C _L =0.1 μF,	—	800	—	μs
Turn off delay	t _{OFF}	V _{IN} = 5.0 V , R _L = 500 Ω , C _L =0.1 μF,	—	5	—	μs

V_{IN} = 5.0 V, TCK22912G

Characteristics	Symbol	Test Condition(Figure 1)	Min	Typ.	Max	Unit
V _{OUT} rise time	t _r	V _{IN} = 5.0 V , R _L = 500 Ω , C _L =0.1 μF,	—	1.4	—	ms
V _{OUT} fall time	t _f	V _{IN} = 5.0 V , R _L = 500 Ω , C _L =0.1 μF,	—	120	—	μs
Turn on delay	t _{ON}	V _{IN} = 5.0 V , R _L = 500 Ω , C _L =0.1 μF,	—	800	—	μs
Turn off delay	t _{OFF}	V _{IN} = 5.0 V , R _L = 500 Ω , C _L =0.1 μF,	—	10	—	μs

V_{IN} = 5.0 V, TCK22913G

Characteristics	Symbol	Test Condition(Figure 1)	Min	Typ.	Max	Unit
V _{OUT} rise time	t _r	V _{IN} = 5.0 V , R _L = 500 Ω , C _L =0.1 μF,	—	1.4	—	ms
V _{OUT} fall time	t _f	V _{IN} = 5.0 V , R _L = 500 Ω , C _L =0.1 μF,	—	60	—	μs
Turn on delay	t _{ON}	V _{IN} = 5.0 V , R _L = 500 Ω , C _L =0.1 μF,	—	800	—	μs
Turn off delay	t _{OFF}	V _{IN} = 5.0 V , R _L = 500 Ω , C _L =0.1 μF,	—	10	—	μs

AC Waveform

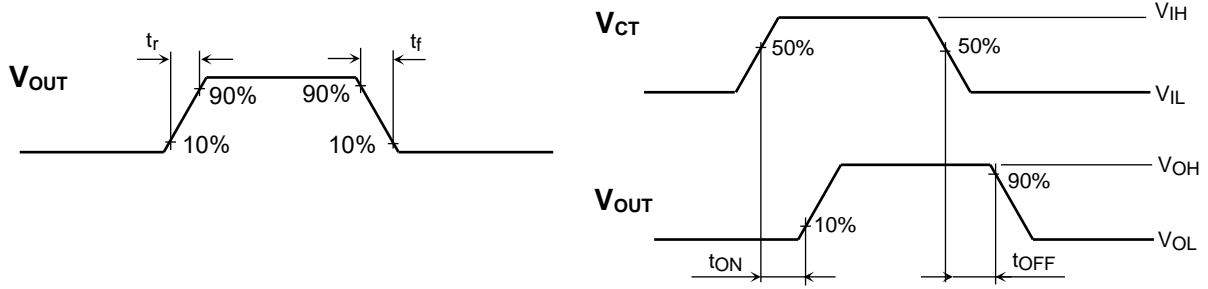

Figure 1 t_r , t_f , t_{ON} , t_{OFF} Waveforms(Active High)

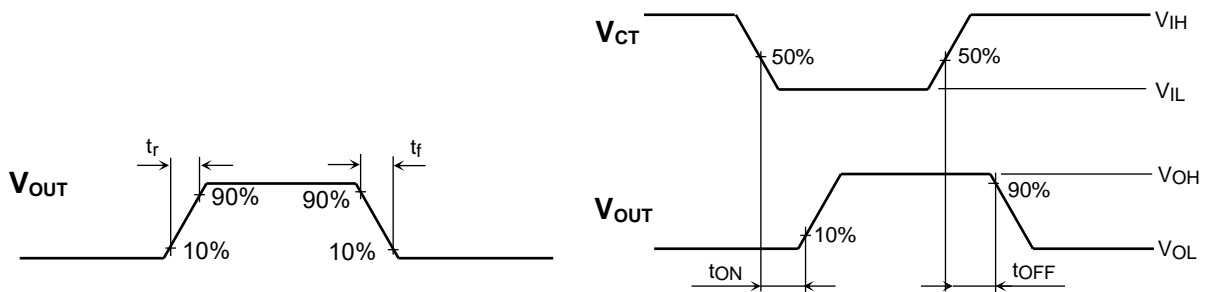
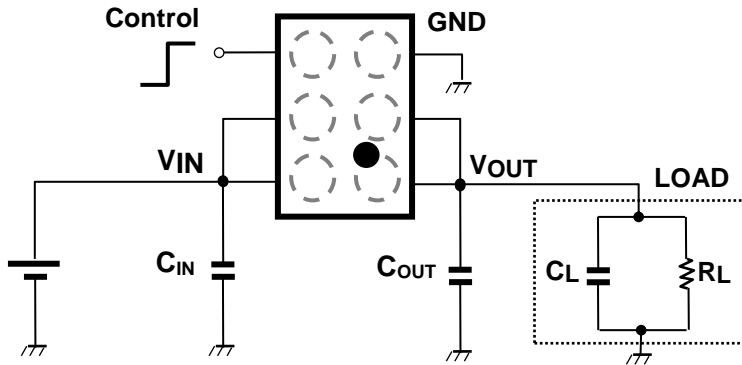

Figure 2 t_r , t_f , t_{ON} , t_{OFF} Waveforms(Active Low)

Application Note

1. Application circuit example (top view)

The figure below shows the example of configuration for TCK2291xG.



1) Input and Output capacitor

An input capacitor (C_{IN}) and an output capacitor (C_{OUT}) are necessary for the stable operation of TCK2291xG. And they are effective to reduce voltage overshoot or undershoot due to sharp changes in output current and also for improved stability of the power supply. When used, place C_{IN} and C_{OUT} more than $1.0\mu\text{F}$ as close to V_{IN} pin and V_{OUT} pin to improve stability of the power supply.

2) Control pin

The Control pin for TCK2291xG controls state of the switch, operated by the control voltage. Control pin is equipped with Schmitt trigger. Also, pull down resistance equivalent to a few $\text{M}\Omega$ is connected between Control and GND. Thus the load switch IC is in OFF state even when Control pin is OPEN. (except TCK22910G and TCK22911G). A control pins for TCK22910G and TCK22911G is Active low. Products that Control pin is an open connection, please use be sure to fix the potential of the Control pin to High or Low.

2. Thermal shutdown function

Each device has a built-in thermal shutdown circuit. If the junction temperature goes beyond 170°C (Typ.), thermal shutdown circuit operates and turns off power switch. When the junction temperature decreases lower than 150°C , the power switch is turned on due to hysteresis. This operation is repeated as long as the junction temperature continues increasing.

3. True reverse current blocking

Each device has built-in true reverse current blocking circuit (TRCB) to block reverse current from V_{OUT} to V_{IN} regardless of output MOSFET ON/OFF condition. (Full-Time Reverse Current Protection)

4. Under-voltage Lockout

Each device has a built-in under-voltage lockout circuit to turn off switch if V_{IN} drops below UVLO. This circuit has hysteresis and UVLO is released when V_{IN} exceeds threshold.

5. Instructions and directions for use

Each device has a built-in several functions, but these do not assure the suppression of uprising device operation. In use of these products, please read through and understand dissipation idea for absolute maximum ratings from the above mention or our 'Semiconductor Reliability Handbook'. Then use these products under absolute maximum ratings in any condition. Furthermore, Toshiba recommends inserting failsafe system into the design.

6. Power Dissipation

Power dissipation is measured on the board condition shown below.

[The Board Condition]

Board material: Glass epoxy (FR4)

Board dimension: 40mm x 40mm (both sides of board), t=1.6mm

Metal pattern ratio: a surface approximately 50%, the reverse side approximately 50%

Through hole: diameter 0.5mm x 28

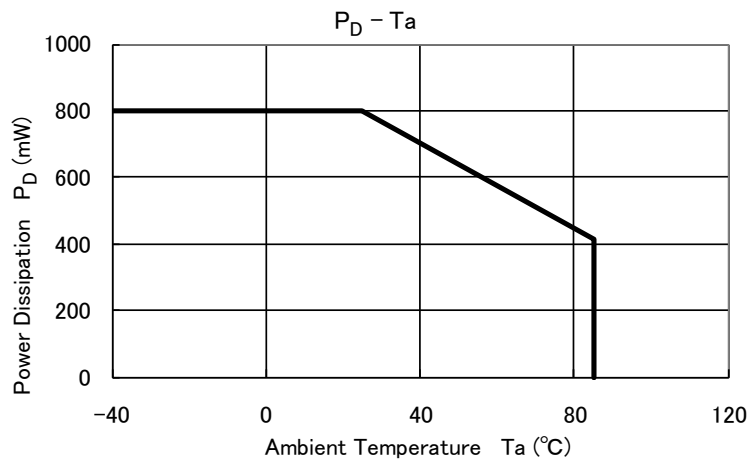

Please allow sufficient margin when designing a board pattern to fit the expected power dissipation. Also take into consideration the ambient temperature, input voltage, output current, etc. and applying the appropriate derating for allowable power dissipation during operation.

TCK2291xG Representative Typical Characteristics

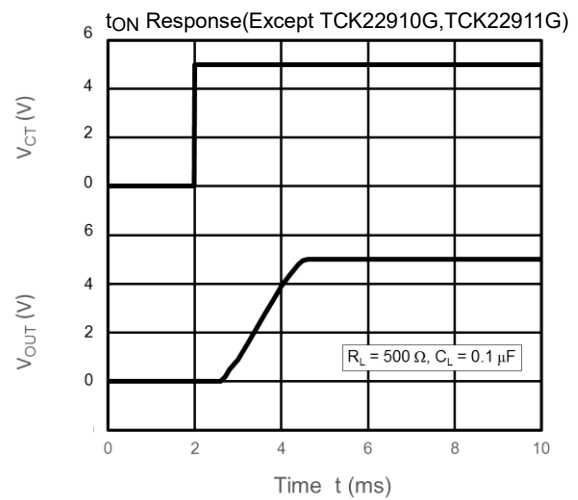
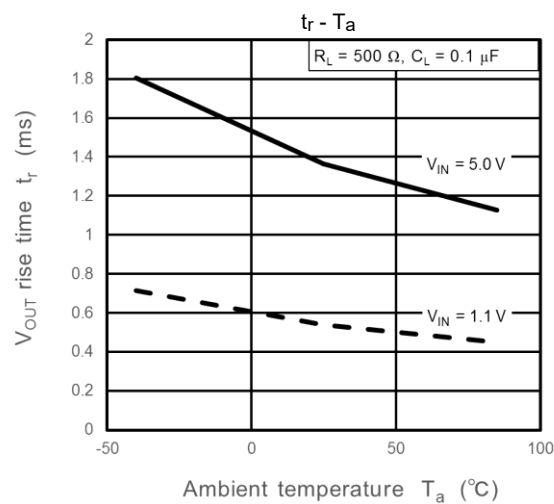
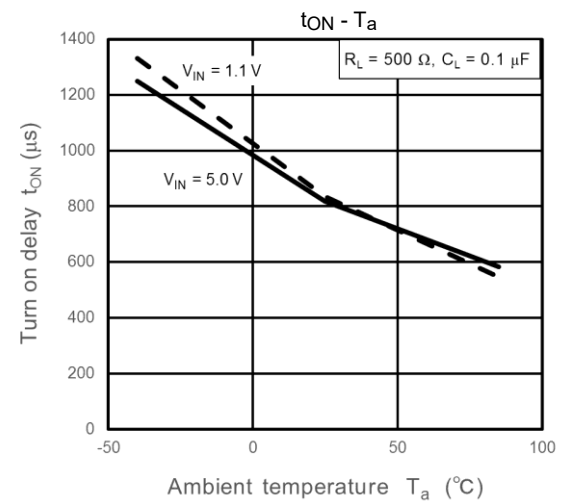
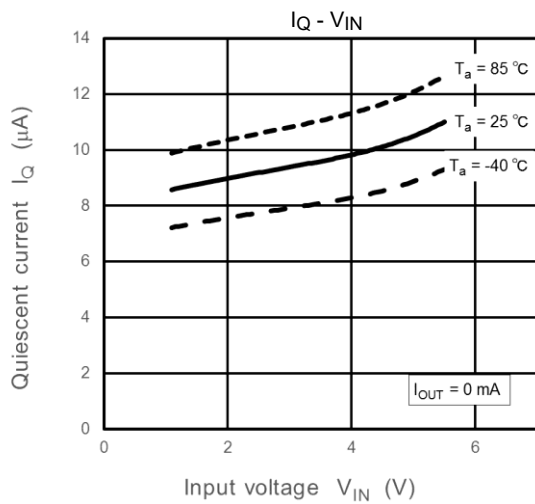
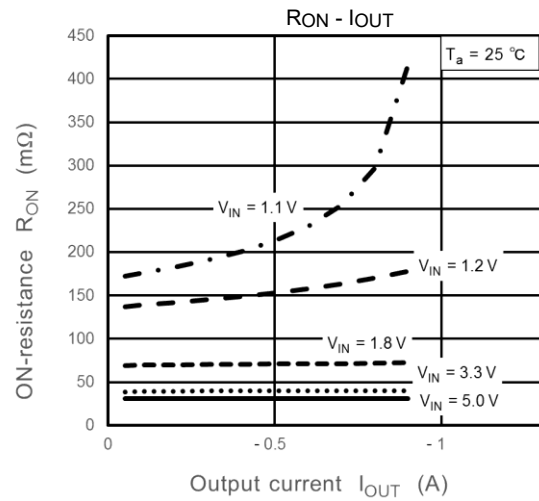
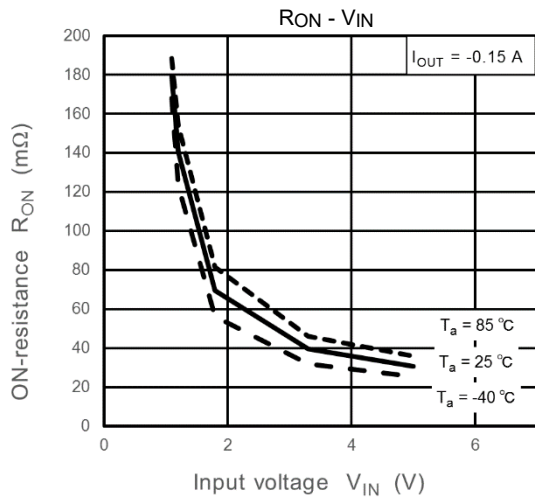

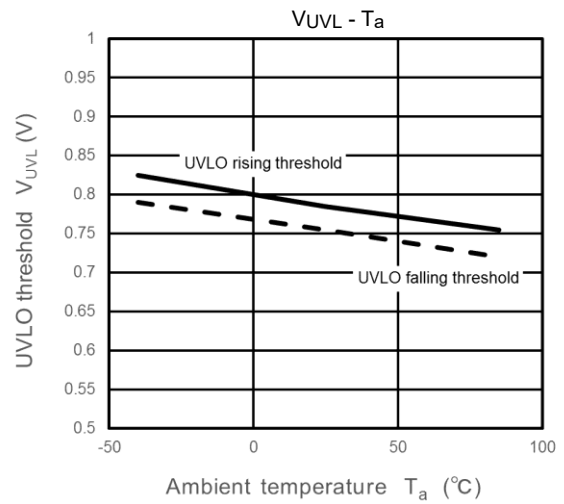
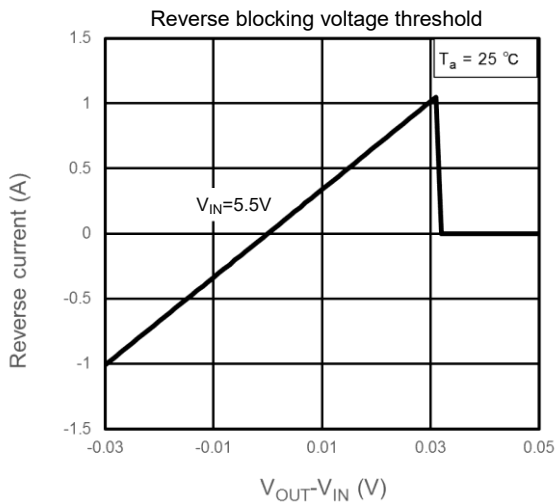

$t_{OFF}-T_a$ Representative Typical Characteristics

TCK22912G, TCK22913G

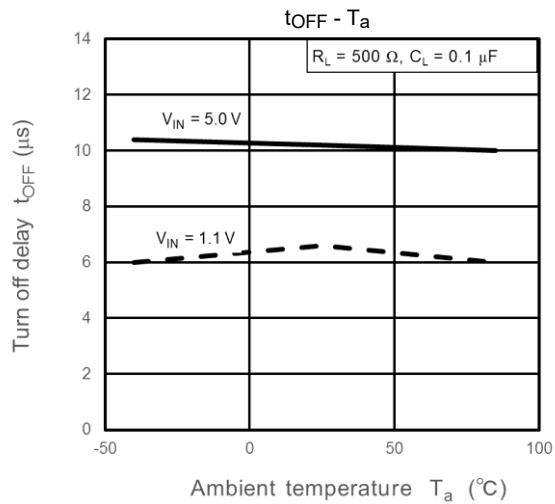

t_f-T_a Representative Typical Characteristics

TCK22910G, TCK22912G

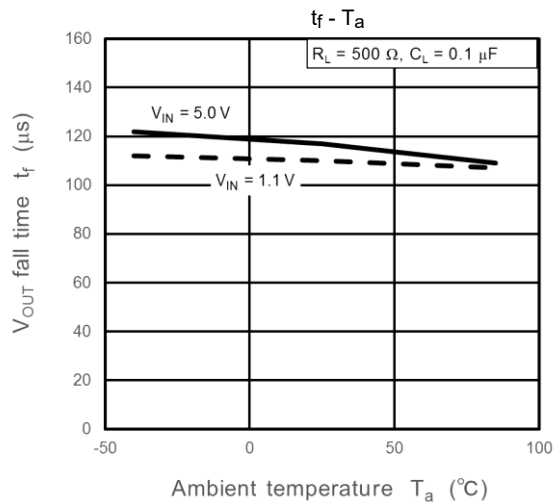

t_{OFF} Response Representative Typical Characteristics

TCK22910G

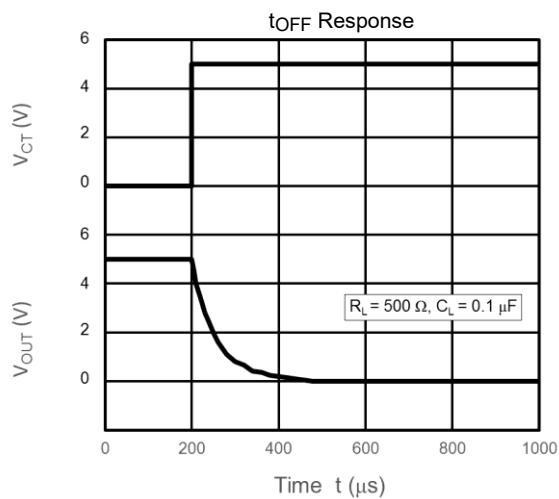

TCK22911G

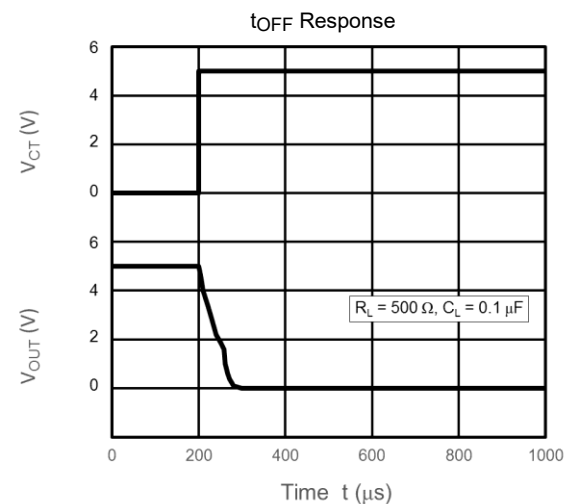

TCK22912

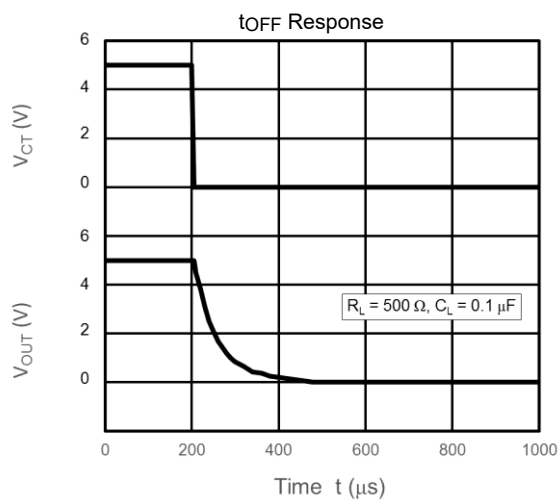

TCK22913G

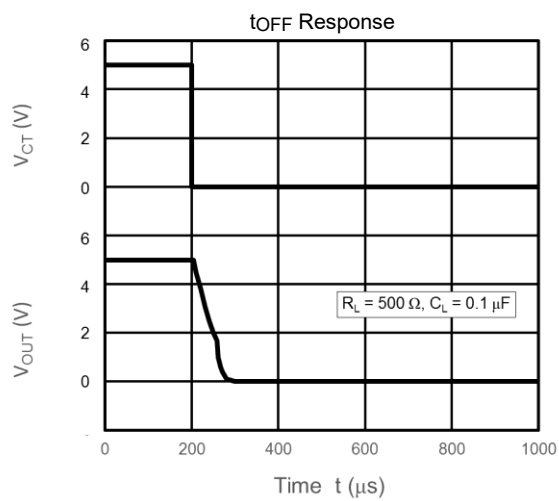

Note: The above characteristics curves are presented for reference only and not guaranteed by production test, unless otherwise noted.

Land pattern dimensions (for reference only)

Unit: mm

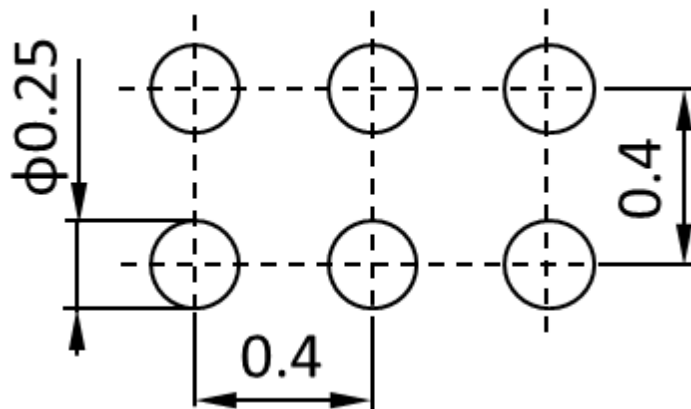

RESTRICTIONS ON PRODUCT USE

Toshiba Corporation and its subsidiaries and affiliates are collectively referred to as "TOSHIBA". Hardware, software and systems described in this document are collectively referred to as "Product".

- TOSHIBA reserves the right to make changes to the information in this document and related Product without notice.
- This document and any information herein may not be reproduced without prior written permission from TOSHIBA. Even with TOSHIBA's written permission, reproduction is permissible only if reproduction is without alteration/omission.
- Though TOSHIBA works continually to improve Product's quality and reliability, Product can malfunction or fail. Customers are responsible for complying with safety standards and for providing adequate designs and safeguards for their hardware, software and systems which minimize risk and avoid situations in which a malfunction or failure of Product could cause loss of human life, bodily injury or damage to property, including data loss or corruption. Before customers use the Product, create designs including the Product, or incorporate the Product into their own applications, customers must also refer to and comply with (a) the latest versions of all relevant TOSHIBA information, including without limitation, this document, the specifications, the data sheets and application notes for Product and the precautions and conditions set forth in the "TOSHIBA Semiconductor Reliability Handbook" and (b) the instructions for the application with which the Product will be used with or for. Customers are solely responsible for all aspects of their own product design or applications, including but not limited to (a) determining the appropriateness of the use of this Product in such design or applications; (b) evaluating and determining the applicability of any information contained in this document, or in charts, diagrams, programs, algorithms, sample application circuits, or any other referenced documents; and (c) validating all operating parameters for such designs and applications. **TOSHIBA ASSUMES NO LIABILITY FOR CUSTOMERS' PRODUCT DESIGN OR APPLICATIONS.**
- **PRODUCT IS NEITHER INTENDED NOR WARRANTED FOR USE IN EQUIPMENTS OR SYSTEMS THAT REQUIRE EXTRAORDINARILY HIGH LEVELS OF QUALITY AND/OR RELIABILITY, AND/OR A MALFUNCTION OR FAILURE OF WHICH MAY CAUSE LOSS OF HUMAN LIFE, BODILY INJURY, SERIOUS PROPERTY DAMAGE AND/OR SERIOUS PUBLIC IMPACT ("UNINTENDED USE").** Except for specific applications as expressly stated in this document, Unintended Use includes, without limitation, equipment used in nuclear facilities, equipment used in the aerospace industry, lifesaving and/or life supporting medical equipment, equipment used for automobiles, trains, ships and other transportation, traffic signaling equipment, equipment used to control combustions or explosions, safety devices, elevators and escalators, and devices related to power plant. **IF YOU USE PRODUCT FOR UNINTENDED USE, TOSHIBA ASSUMES NO LIABILITY FOR PRODUCT.** For details, please contact your TOSHIBA sales representative or contact us via our website.
- Do not disassemble, analyze, reverse-engineer, alter, modify, translate or copy Product, whether in whole or in part.
- Product shall not be used for or incorporated into any products or systems whose manufacture, use, or sale is prohibited under any applicable laws or regulations.
- The information contained herein is presented only as guidance for Product use. No responsibility is assumed by TOSHIBA for any infringement of patents or any other intellectual property rights of third parties that may result from the use of Product. No license to any intellectual property right is granted by this document, whether express or implied, by estoppel or otherwise.
- **ABSENT A WRITTEN SIGNED AGREEMENT, EXCEPT AS PROVIDED IN THE RELEVANT TERMS AND CONDITIONS OF SALE FOR PRODUCT, AND TO THE MAXIMUM EXTENT ALLOWABLE BY LAW, TOSHIBA (1) ASSUMES NO LIABILITY WHATSOEVER, INCLUDING WITHOUT LIMITATION, INDIRECT, CONSEQUENTIAL, SPECIAL, OR INCIDENTAL DAMAGES OR LOSS, INCLUDING WITHOUT LIMITATION, LOSS OF PROFITS, LOSS OF OPPORTUNITIES, BUSINESS INTERRUPTION AND LOSS OF DATA, AND (2) DISCLAIMS ANY AND ALL EXPRESS OR IMPLIED WARRANTIES AND CONDITIONS RELATED TO SALE, USE OF PRODUCT, OR INFORMATION, INCLUDING WARRANTIES OR CONDITIONS OF MERCHANTABILITY, FITNESS FOR A PARTICULAR PURPOSE, ACCURACY OF INFORMATION, OR NONINFRINGEMENT.**
- Do not use or otherwise make available Product or related software or technology for any military purposes, including without limitation, for the design, development, use, stockpiling or manufacturing of nuclear, chemical, or biological weapons or missile technology products (mass destruction weapons). Product and related software and technology may be controlled under the applicable export laws and regulations including, without limitation, the Japanese Foreign Exchange and Foreign Trade Law and the U.S. Export Administration Regulations. Export and re-export of Product or related software or technology are strictly prohibited except in compliance with all applicable export laws and regulations.
- Please contact your TOSHIBA sales representative for details as to environmental matters such as the RoHS compatibility of Product. Please use Product in compliance with all applicable laws and regulations that regulate the inclusion or use of controlled substances, including without limitation, the EU RoHS Directive. **TOSHIBA ASSUMES NO LIABILITY FOR DAMAGES OR LOSSES OCCURRING AS A RESULT OF NONCOMPLIANCE WITH APPLICABLE LAWS AND REGULATIONS.**

X-ON Electronics

Largest Supplier of Electrical and Electronic Components

Click to view similar products for [Power Switch ICs - Power Distribution](#) category:

Click to view products by [Toshiba](#) manufacturer:

Other Similar products are found below :

[TCK111G,LF\(S\)](#) [FPF1018](#) [DS1222](#) [TCK2065G,LF](#) [SZNCP3712ASNT3G](#) [MIC2033-05BYMT-T5](#) [MIC2033-12AYMT-T5](#) [MIC2033-05BYM6-T5](#) [SLG5NT1437VTR](#) [SZNCP3712ASNT1G](#) [NCV330MUTBG](#) [DML1008LDS-7](#) [KTS1670EDA-TR](#) [KTS1640QGDV-TR](#) [KTS1641QGDV-TR](#) [NCV459MNWTBG](#) [FPF2260ATMX](#) [U6513A](#) [MIC2012YM-TR](#) [NCP45780IMN24RTWG](#) [MAX14919ATP+](#) [MC33882PEP](#) [TPS2104DBVR](#) [MIC2098-1YMT-TR](#) [MIC94062YMT TR](#) [MP6231DN-LF](#) [MIC2075-2YM](#) [MIC94068YML-TR](#) [SIP32461DB-T2-GE1](#) [NCP335FCT2G](#) [TCK105G,LF\(S\)](#) [AP2191DWG-7](#) [AP2151DSG-13](#) [MIC94094YC6-TR](#) [MIC94064YC6-TR](#) [MIC2505-1YM](#) [MIC94305YMT-TR](#) [MIC94085YFT-TR](#) [MIC94081YFT-TR](#) [MIC94042YFL-TR](#) [MIC94041YFL-TR](#) [MIC2005-1.2YM6-TR](#) [TPS2032QDRQ1](#) [SIP32510DT-T1-GE3](#) [NCP333FCT2G](#) [BTS3050TFATMA1](#) [NCP331SNT1G](#) [TPS2092DR](#) [TPS2063DR](#) [TPS2042P](#)