

TOSHIBA CMOS Linear Integrated Circuit Silicon Monolithic

# TCR1HF Series

High voltage, Low quiescent current, Fast load transient CMOS Linear Regulator

## 1. Description

TCR1HF series are CMOS general-purpose single-output voltage regulators with 40 V high voltage, 1  $\mu$ A low quiescent current, high response load transient, an on/off control input.

These voltage regulators are available in fixed output voltages between 1.8 V and 5.0 V and capable of driving up to 150 mA. They feature Overcurrent protection, Thermal shutdown and Auto-discharge.

The TCR1HFxx series is offered in the standard small plastic mold package SMV (2.9 mm x 2.8 mm x 1.1 mm (Typ.)).

## 2. Applications

Power supply applications for mobile devices and home appliances that require low standby power with high voltage input

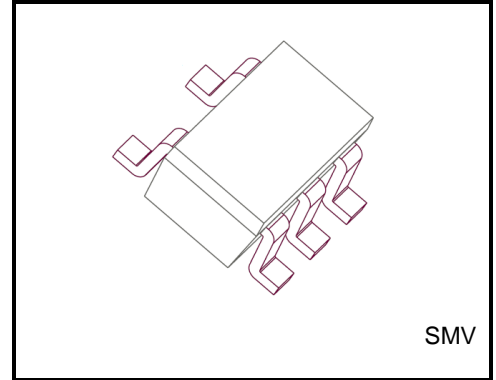

Weight:  
SMV (SOT-25) (SC-74A) : 16 mg (Typ.)

## 3. Features

- High input voltage 40 V (Absolute Maximum ratings), 4 V to 36 V (Operation input voltage)
- Low quiescent current  $I_{B(ON)}$ : 1  $\mu$ A (Typ.) @  $I_{OUT} = 0$  mA
- High response load transient  
-60 mV / +50 mV @ 3.3 V output,  $I_{OUT} = 0$  mA  $\leftrightarrow$  10 mA
- Wide range output voltage line up ( $V_{OUT} = 1.8$  V to 5.0 V)
- High accuracy output voltage  $\pm 1$  % ( $T_a = 25$  °C)
- Auto-discharge (TCR1HFxxA series Only)
- Overcurrent protection
- Thermal shutdown
- In rush current reduction
- Pull up connection between CONTROL and VIN
- Ceramic capacitors can be used
- General package SMV (SOT-25) (2.8 mm x 2.9 mm x 1.1 mm)

Start of commercial production  
2023-02

### 4. Absolute Maximum Ratings (Ta = 25 °C)

Characteristics	Symbol	Rating	Unit
Input voltage	V <sub>IN</sub>	-0.3 to 40	V
Control voltage	V <sub>CT</sub>	-0.3 to 40	V
Output voltage	V <sub>OUT</sub>	-0.3 to 6	V
Output current	I <sub>OUT</sub>	150	mA
Power dissipation	P <sub>D</sub>	200 (Note1)	mW
		580 (Note2)	
Junction temperature	T <sub>J</sub>	150	°C
Storage temperature range	T <sub>stg</sub>	-55 to 150	°C

Note: Using continuously under heavy loads (e.g. the application of high temperature/current/voltage and the significant change in temperature, etc.) may cause this product to decrease in the reliability significantly even if the operating conditions (i.e. operating temperature/current/voltage, etc.) are within the absolute maximum ratings and the operating ranges.

Please design the appropriate reliability upon reviewing the Toshiba Semiconductor Reliability Handbook (“Handling Precautions”/“Derating Concept and Methods”) and individual reliability data (i.e. reliability test report and estimated failure rate, etc).

Note 1: Unit Rating

Note 2: Rating at mounting on a board  
(FR4 board: 25.4 mm x 25.4 mm x 1.6 mm)

### 5. Pin Assignment (top view)

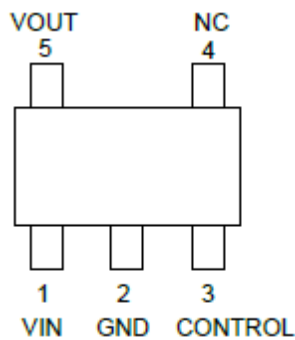

Start of commercial production  
2023-01

### 6. Operating Ranges

Characteristics	Symbol	Rating		Unit
Input voltage	$V_{IN}$	$V_{OUT} \leq 3.3 \text{ V}$	4.0 to 36.0 (Note 2)	V
		$V_{OUT} > 3.3 \text{ V}$	$V_{OUT} +1$ to 36.0 (Note 2)	V
Control voltage	$V_{CT}$	0 to $V_{IN}$		V
Output voltage	$V_{OUT}$	1.8 to 5.0		V
Output current	$I_{OUT}$	DC	150 (Note 3)	mA
Operation Temperature	$T_{opr}$	-40 to 125		°C
Output Capacitance	$C_{OUT}$	$\geq 0.47$		$\mu\text{F}$

Note 2: Please refer to Dropout Voltage table(Page 5) and use it within Absolute Maximum Ratings Junction temperature and Operation Temperature Ranges

Note 3: There is possibility for significant negative affect for reliability, if this product used long time on the state includes limit or very close condition on Operating ranges.

### 7. List of Products Number, Output voltage and Marking

Product No.	Output voltage(V)	Auto Discharge	Marking
TCR1HF18A	1.8	Integrated	1D8
TCR1HF25A	2.5		2D5
TCR1HF28A	2.8		2D8
TCR1HF30A	3.0		3D0
TCR1HF31A	3.1		3D1
TCR1HF32A	3.2		3D2
TCR1HF33A	3.3		3D3
TCR1HF50A	5.0		5D0
TCR1HF18B	1.8	—	1X8
TCR1HF25B	2.5		2X5
TCR1HF28B	2.8		2X8
TCR1HF30B	3.0		3X0
TCR1HF31B	3.1		3X1
TCR1HF32B	3.2		3X2
TCR1HF33B	3.3		3X3
TCR1HF50B	5.0		5X0

### Marking (top view)

Example: TCR1HF50B (5.0 V output,)

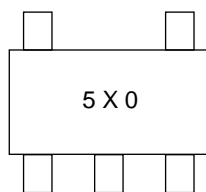

### Block Diagram

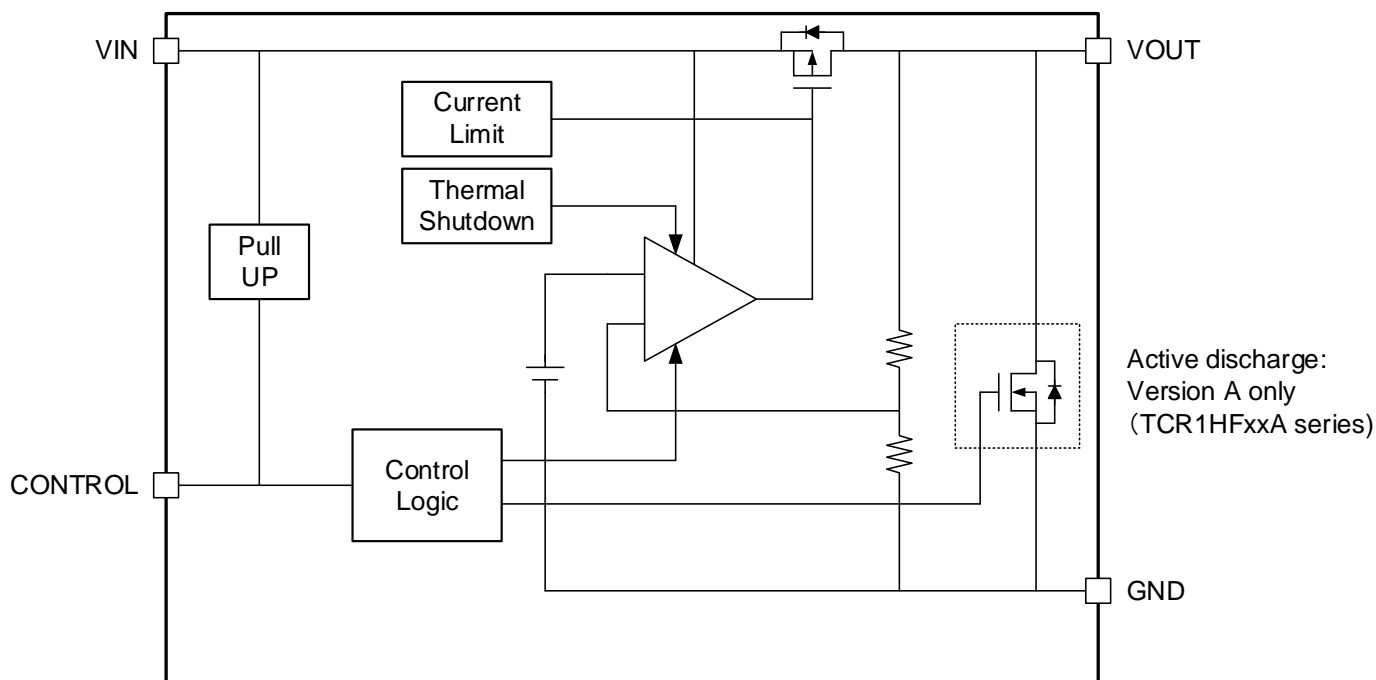

### 8. Electrical Characteristics

(Unless otherwise specified,  $V_{IN} = 24\text{ V}$ ,  $I_{OUT} = 20\text{ mA}$ ,  $C_{IN} = C_{OUT} = 0.47\text{ }\mu\text{F}$ )

Characteristics	Symbol	Test Condition	$T_j = 25^\circ\text{C}$			$T_j = -40\text{ to }125^\circ\text{C}$ (Note 8)		Unit	
			Min	Typ.	Max	Min	Max		
Output voltage accuracy	$V_{OUT}$	$I_{OUT} = 10\text{ mA}$ (Note 4)	-1.0	—	+1.0	-3.5	2.0	%	
Input Voltage Range	$V_{IN}$	$I_{OUT} = 1\text{ mA}$ , $V_{OUT} \leq 3.3\text{ V}$	4	—	36	4	36	V	
		$I_{OUT} = 1\text{ mA}$ , $V_{OUT} > 3.3\text{ V}$	$V_{IN} + 1$	—	36	$V_{IN} + 1$	36	V	
Line regulation	Reg-line	$I_{OUT} = 1\text{ mA}$ (Note 5)	—	0	—	—	—	mV	
Load regulation	Reg-load	$0\text{ mA} \leq I_{OUT} \leq 40\text{ mA}$ (Note 6)	—	3.5	—	—	—	mV	
Quiescent current	$I_{BON}$	$I_{OUT} = 0\text{ mA}$	—	1	1.4	—	1.6	$\mu\text{A}$	
Stand-by current	$I_{B(OFF1)}$	$V_{CT} = 0\text{ V}$ , $V_{IN} = 4\text{ V}$	—	0.24	0.39	—	0.45	$\mu\text{A}$	
	$I_{B(OFF2)}$	$V_{CT} = 0\text{ V}$ , $V_{IN} = 24\text{ V}$	—	0.27	0.42	—	0.48	$\mu\text{A}$	
Control pull down current	$I_{CT}$	—	—	60	—	—	—	nA	
Drop-out voltage	$V_{DO}$	$I_{OUT} = 150\text{ mA}$	$V_{OUT} = 1.8\text{ V}$	—	760	—	—	1060	mV
			$V_{OUT} = 2.5\text{ V}$	—	670	—	—	920	mV
			$V_{OUT} = 2.8\text{ V}$	—	580	—	—	855	mV
			$V_{OUT} = 3.0\text{ V}$	—	535	—	—	820	mV
			$V_{OUT} = 3.1\text{ V}$	—	520	—	—	790	mV
			$V_{OUT} = 3.2\text{ V}$	—	520	—	—	780	mV
			$V_{OUT} = 3.3\text{ V}$	—	510	—	—	760	mV
			$V_{OUT} = 5.0\text{ V}$	—	415	—	—	660	mV
Output current limit	ICL	$V_{OUT} = V_{OUT(NOM)} * 90\%$	300	—	—	200	—	mA	
Output noise voltage	$V_{NO}$	$I_{OUT} = 10\text{ mA}$ , $10\text{ Hz} \leq f \leq 100\text{ kHz}$ , $T_a = 25^\circ\text{C}$ (Note 6)	—	100	—	—	—	$\mu\text{V}_{rms}$	
Ripple rejection ratio	R.R.	$V_{IN} = 4\text{ V}$ , $I_{OUT} = 10\text{ mA}$ , $f = 1\text{ kHz}$ , $V_{IN\_Ripple} = 100\text{ mV p-p}$ , $T_a = 25^\circ\text{C}$ (Note 6)	—	60	—	—	—	dB	
Output voltage slew rate	$V_{OUTSR}$	—	—	10	—	—	—	mV / $\mu\text{s}$	
Load transient response	$\Delta V_{OUT}$	$I_{OUT} = 0\text{ mA} \rightarrow 10\text{ mA}$ , $1\text{ }\mu\text{s}$ $C_{OUT} = 1\text{ }\mu\text{F}$ (Note 7)	—	-60	—	—	—	mV	
		$I_{OUT} = 10\text{ mA} \rightarrow 0\text{ mA}$ , $1\text{ }\mu\text{s}$ $C_{OUT} = 1\text{ }\mu\text{F}$ (Note 7)	—	+50	—	—	—	mV	
Control pin threshold voltage	$V_{CT(ON)}$	—	0.9	—	$V_{IN}$	1.0	$V_{IN}$	V	
	$V_{CT(OFF)}$	—	0	—	0.47	0	0.4	V	
Thermal shutdown threshold	$T_{SDH}$	$T_j$ rising	—	155	—	—	—	$^\circ\text{C}$	
	$T_{SDL}$	$T_j$ falling	—	145	—	—	—	$^\circ\text{C}$	
Discharge on resistance	$R_{SD}$	$V_{OUT} = 3.3\text{ V}$ , $I_{OUT} = -10\text{ mA}$ , $T_j = 25^\circ\text{C}$ , TCR1HFxxA Only	—	60	—	—	—	$\Omega$	

Note 4: stable state with fixed  $I_{OUT}$  condition

Note 5:  $4\text{ V} \leq V_{IN} \leq 24\text{ V}$  ( $V_{OUT} \leq 3.3\text{ V}$ )  
 $V_{OUT} + 1\text{ V} \leq V_{IN} \leq 24\text{ V}$  ( $V_{OUT} > 3.3\text{ V}$ )

Note 6:  $V_{OUT} = 3.3\text{ V}$

Note 7:  $V_{IN} = 4.0\text{ V}$  ( $V_{OUT} \leq 3.3\text{ V}$ )  
 $V_{IN} = V_{OUT} + 1\text{ V}$  ( $V_{OUT} > 3.3\text{ V}$ )

Note 8: This parameter is warranted by design.

### 9. Application note

#### 9.1. Recommended Application Circuit

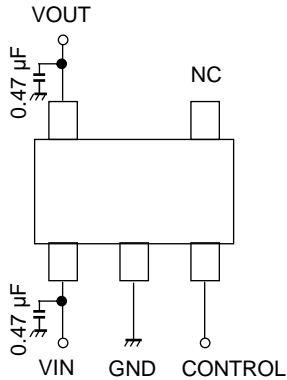

CONTROL voltage	Output voltage
HIGH	ON
LOW	OFF
OPEN	ON

The figure above shows the recommended configuration for using this device. Insert a capacitor at VOUT and VIN pins for stable input / output operation. (Ceramic capacitors can be used).

#### 9.2. Power Dissipation

Both unit and board-mounted power dissipation ratings for TCR1HF series are available in the Absolute Maximum Ratings table.

Power dissipation is measured on the board shown below.

##### Board conditions

\*Board material: FR4 board

Board dimension: 25.4 mm × 25.4 mm × 1.6 mm

Copper area: 645 mm<sup>2</sup>

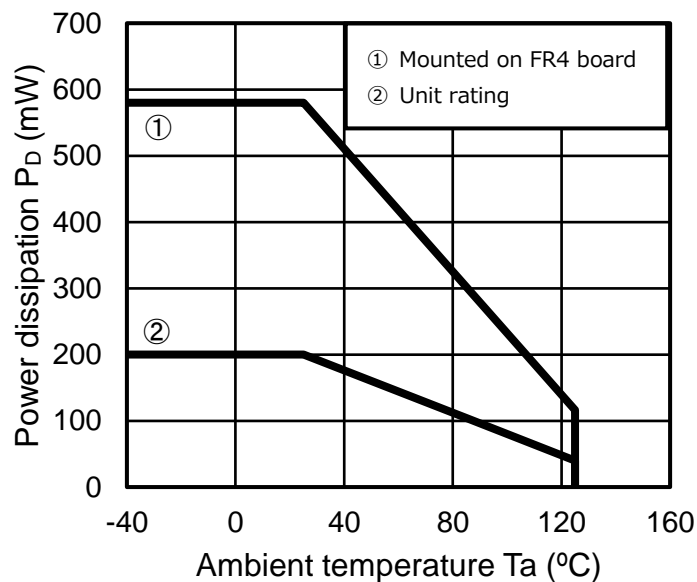

### 9.3. About VOUT output immediately after VIN is applied

Depending on the VIN voltage and application speed, VOUT voltage may occur due to leakage current from VIN to VOUT even when CONTROL = L.

If VOUT voltage occurs and becomes a problem, it is necessary to take countermeasures such as changing the COUT capacitance or changing the power supply start-up speed.

Is required. Make sure that there are no problems by performing thorough evaluations, including the temperature characteristics, in an actual application.

Make sure that there are no problems by performing thorough evaluations, including the temperature characteristics, in an actual application.

Example of VOUT output immediately after applying VIN

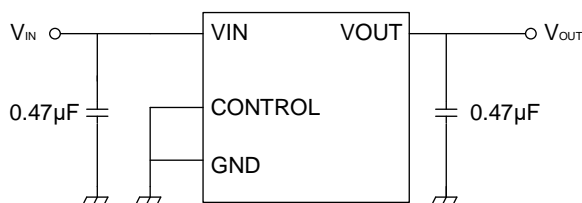

TCR1HF33B, VIN = 0 V to 36 V, No Load

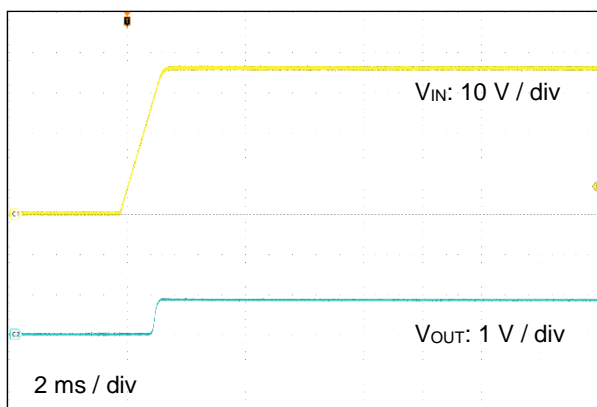

TCR1HF33B, VIN = 0 V to 24 V, No Load

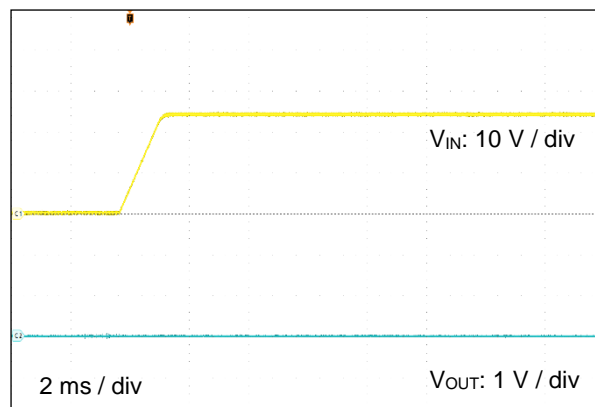

In addition, when VIN is changing, a leak current occurs and VOUT is output. Therefore, if the output is loaded, the VOUT voltage will drop. (1 MΩ, etc.)

TCR1HF33B, VIN = 0 V to 36 V, No Load

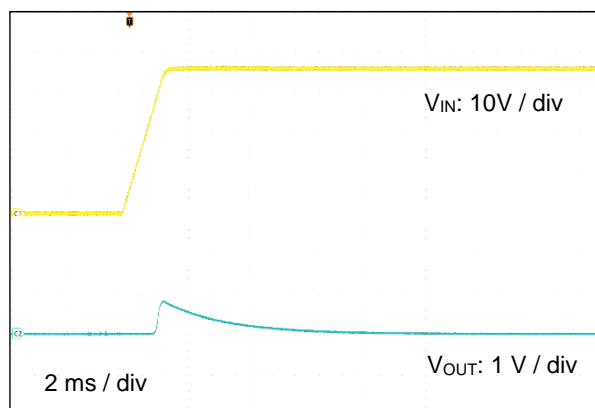
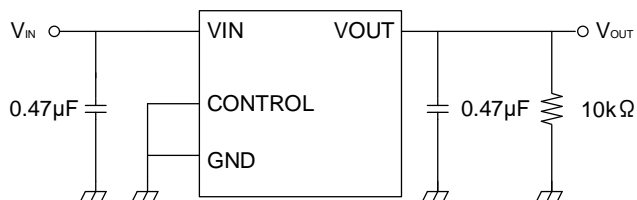

## 9.4. Attention in Use

- Input/Output capacitors

Ceramic capacitors can be used with the IC, however some type capacitors may have very large temperature dependence. Please consider usage environment condition carefully to select the capacitors. Toshiba recommends under 10 ohm ESR capacitors.

Please use over 0.47  $\mu\text{F}$  capacitor as  $C_{\text{OUT}}$  for stable operation. If without any capacitors attached to  $C_{\text{OUT}}$ , there is a possibility to destroy or have a significant adverse effect on the IC.

The input capacitor  $C_{\text{IN}}$  is not always required for stable operation of this device, however Toshiba recommends over 0.47  $\mu\text{F}$  capacitor to improve the characteristics.

There is a possibility to generate some voltage on  $V_{\text{OUT}}$  in case  $V_{\text{IN}}$  rises from 0 V even in the state  $\text{CONTROL} = \text{L}$ .

In such case on the products without discharge function, the voltage is on  $V_{\text{OUT}}$  until the consumption current is generated to the outside load.

Additionally, if the  $V_{\text{IN}}$  is rapidly fluctuating the  $V_{\text{OUT}}$  possibly to fluctuate transiently, regardless whether this device is stopped or operating.

In such case please confirm that there are no problems with sufficient evaluation includes temperature dependence in actual applications,

using bigger  $C_{\text{IN}}$  to suppress the changing value on  $V_{\text{IN}}$  rising, or using bigger  $C_{\text{OUT}}$  to suppress the  $V_{\text{OUT}}$  fluctuation.

- Mounting

The long distance between IC and output capacitor might affect phase assurance by impedance in wire and inductor. For stable power supply, output capacitor need to mount near IC as much as possible. Also  $V_{\text{IN}}$  and GND pattern need to be large and make the wire impedance small as possible.

- Permissible Loss

Please have enough design patterns for expected maximum permissible loss. And under consideration of surrounding temperature, input voltage, and output current etc., we recommend proper dissipation ratings for maximum permissible loss; in general maximum dissipation rating is 70 to 80 %.

- Over current Protection and Thermal shut down function

Over current protection and Thermal shut down function are designed in these products, but these are not designed to constantly ensure the suppression of the device within operation limits. Depending on the condition during actual usage, it could affect the electrical characteristic specification and reliability. Also note that if output pins and GND pins are not completely shorted out, these products might be break down.

When using these products, please read through and understand the concept of dissipation for absolute maximum ratings from the above mention or our 'Semiconductor Reliability Handbook'. Then use these products under absolute maximum ratings in any condition. Furthermore, Toshiba recommend inserting failsafe system into the design.



### 10. Representative Typical Characteristics

#### 10.1. Output Voltage vs. Output Current

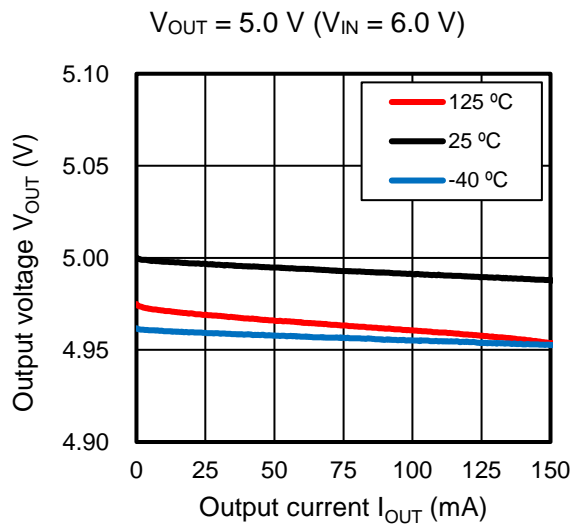
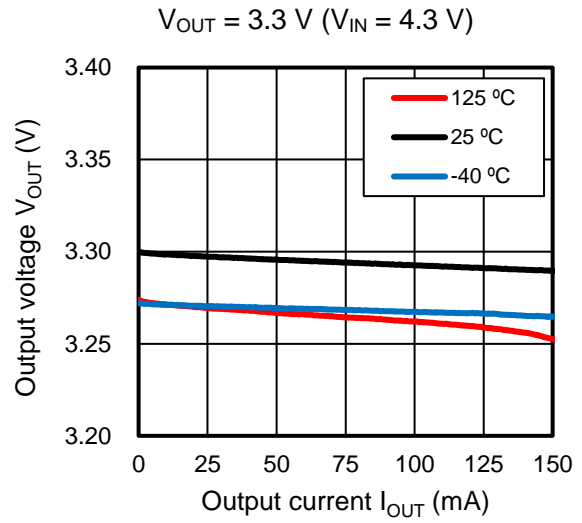
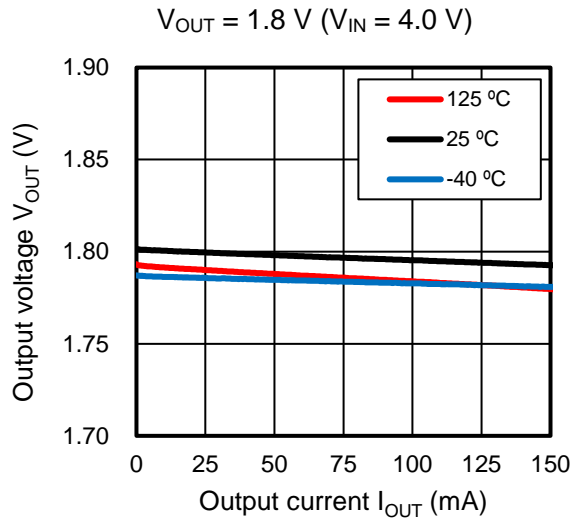

### 10.2. Output Voltage vs. Input Voltage

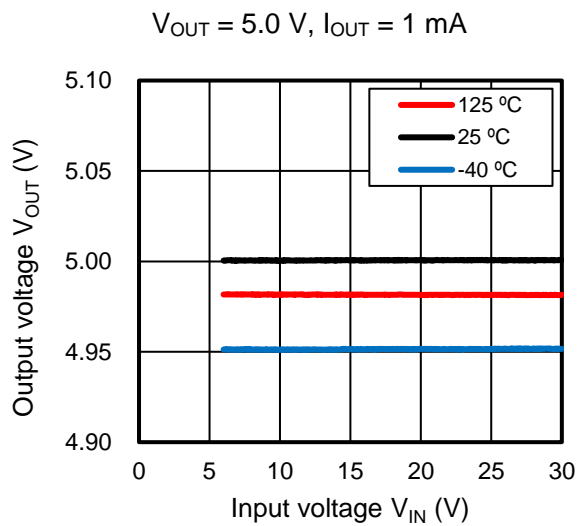
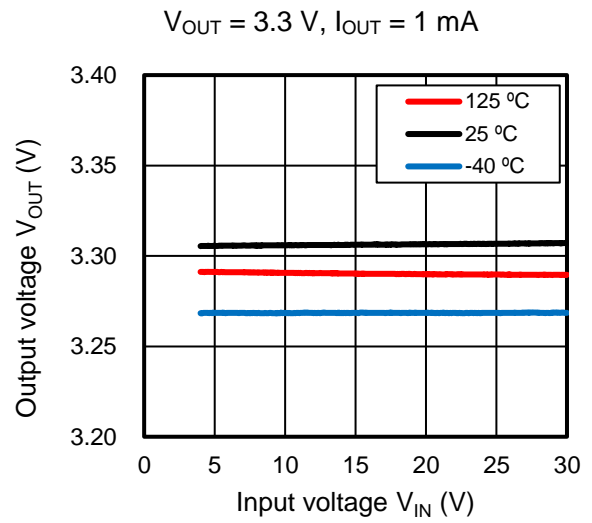
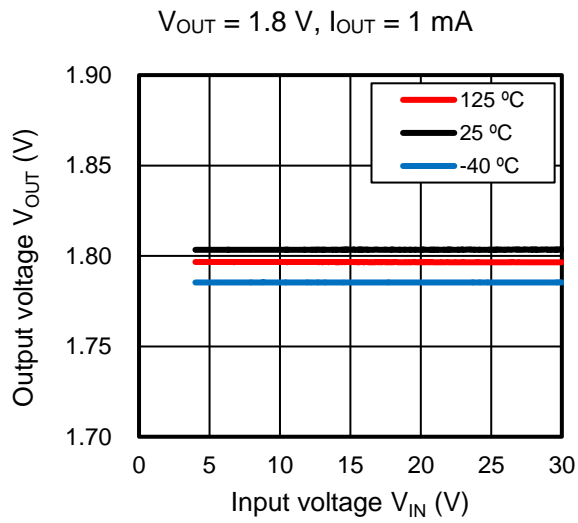

### 10.3. Dropout Voltage vs. Output Current

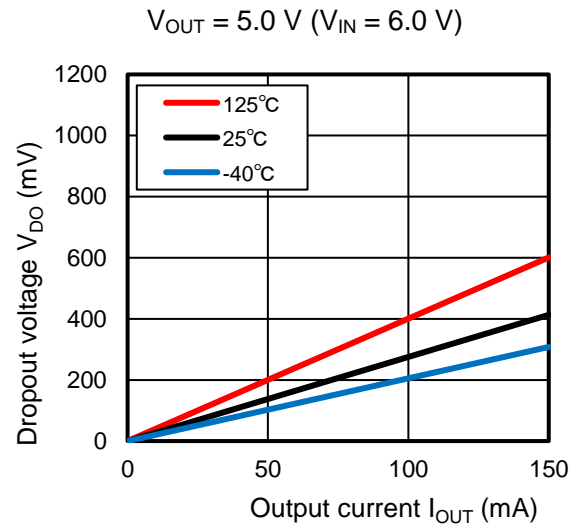
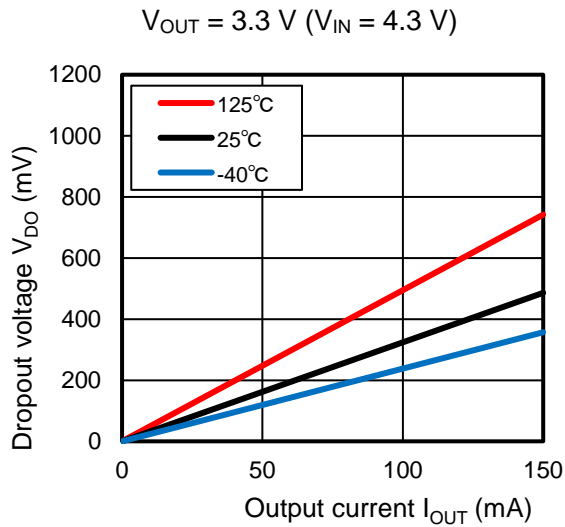

### 10.4. Quiescent Current vs. Input Voltage ( $I_{OUT} = 0\text{ mA}$ )

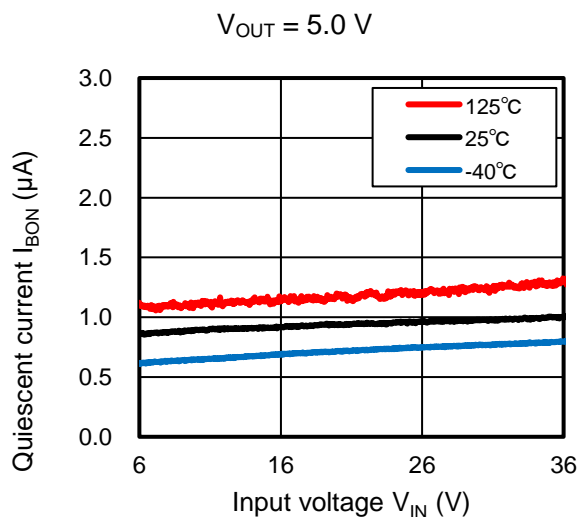
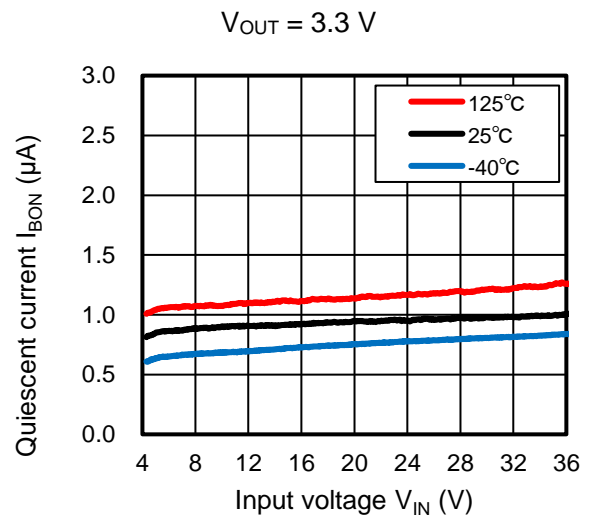
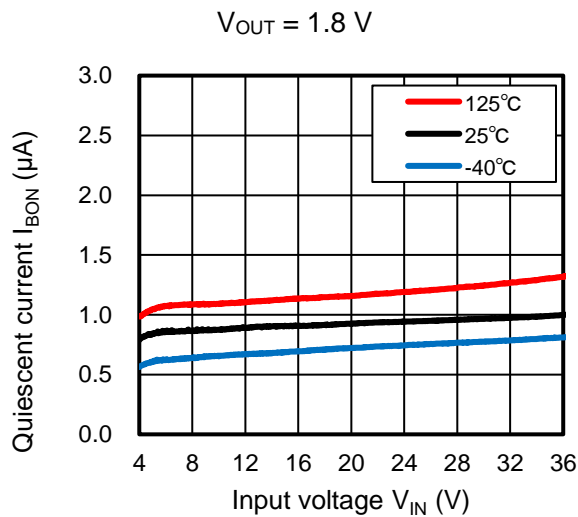

### 10.5. Quiescent Current vs. Output Current

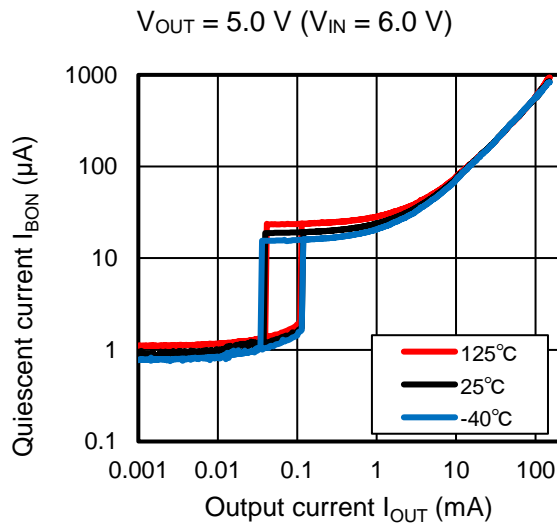
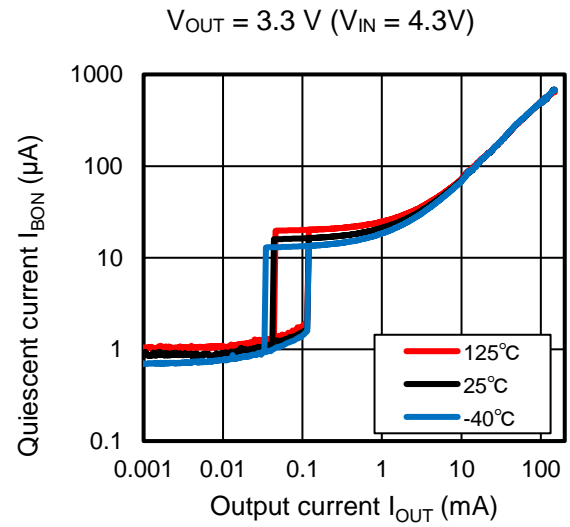
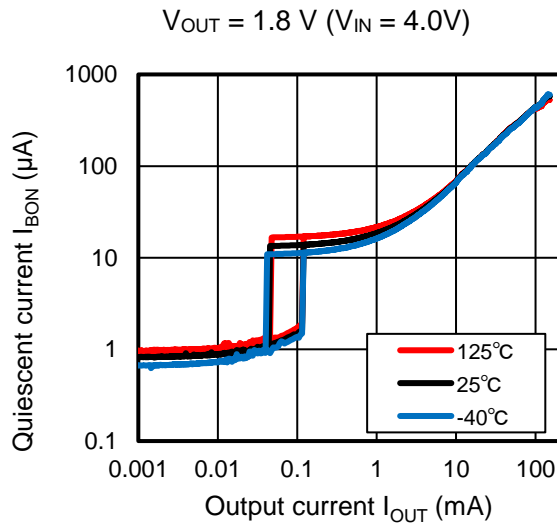

### 10.6. Standby Current vs. Input voltage

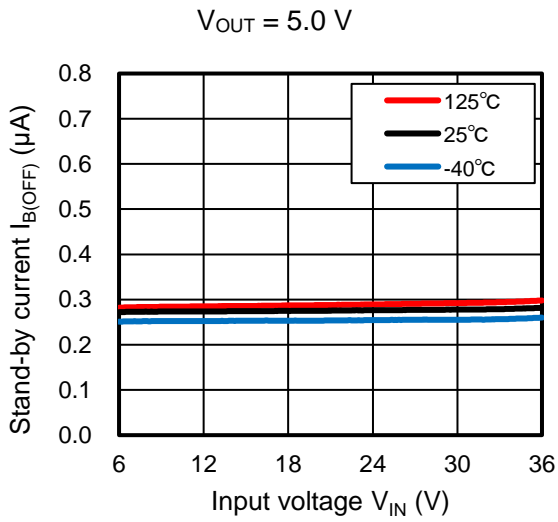
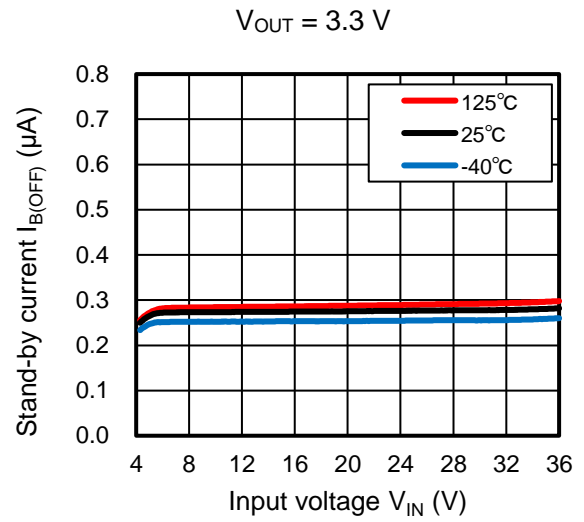
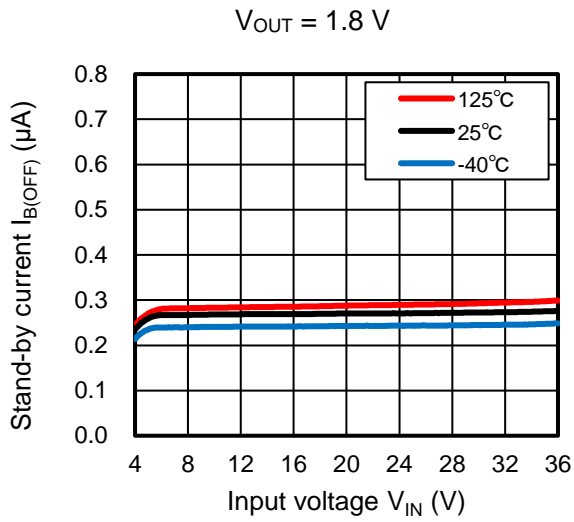

### 10.7. Output Current Limit

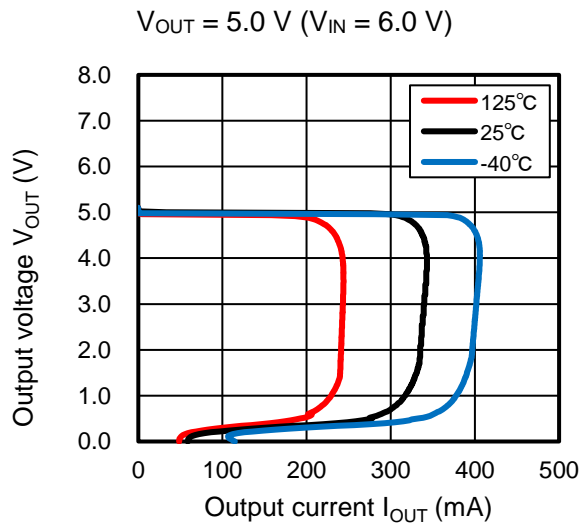
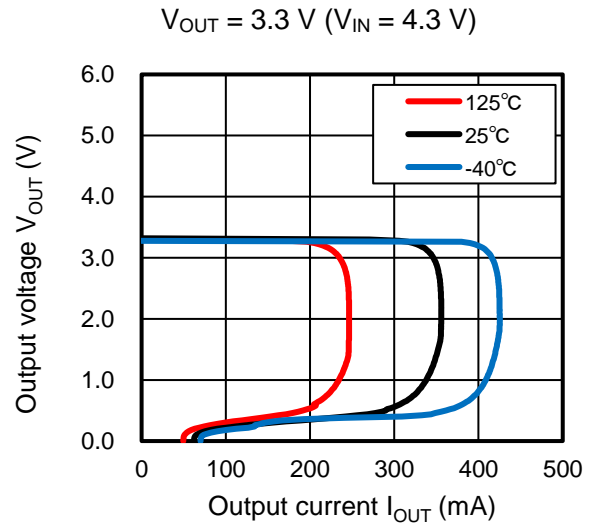
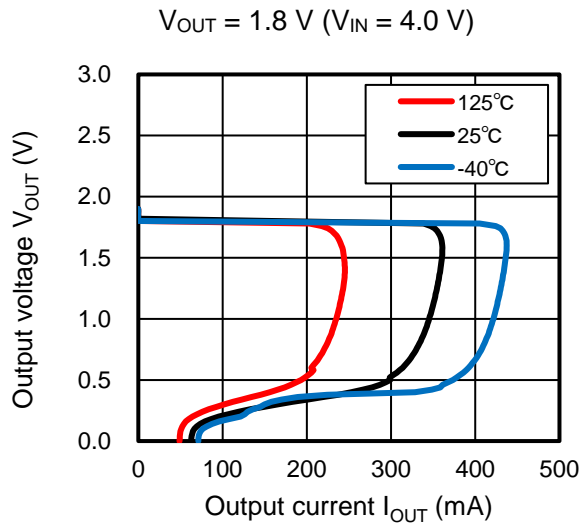

### 10.8. Ripple rejection Ratio vs. Frequency

( $C_{IN}$  = none,  $C_{OUT}$  = 0.47  $\mu$ F,  $V_{IN}$  Ripple = 100 mV p-p,  $I_{OUT}$  = 10 mA,  $T_a$  = 25  $^{\circ}$ C)

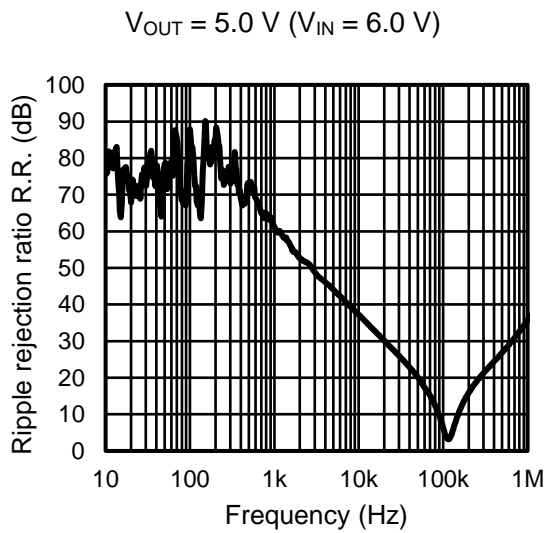
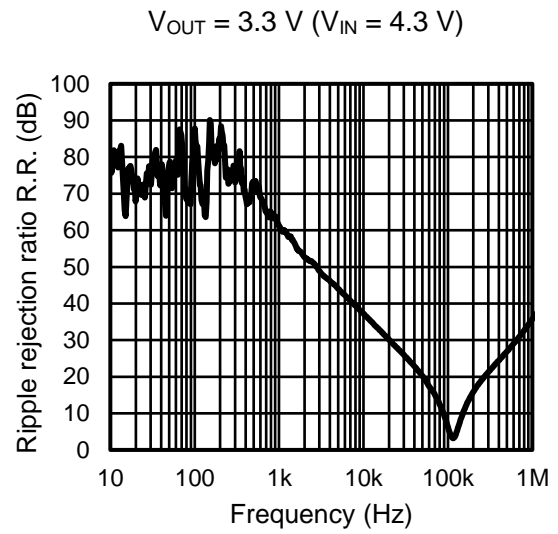
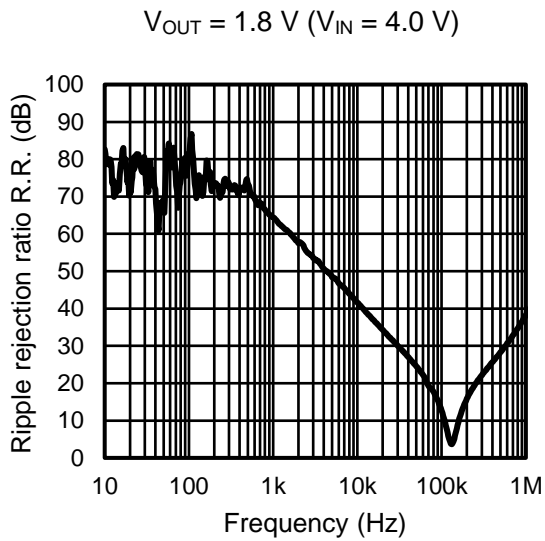

### 10.9. Output noise Voltage

( $C_{IN} = 0.47 \mu\text{F}$ ,  $C_{OUT} = 0.47 \mu\text{F}$ ,  $V_{IN} = 24 \text{ V}$ ,  $I_{OUT} = 10 \text{ mA}$ ,  $T_a = 25 \text{ }^\circ\text{C}$ )

$V_{OUT} = 1.8 \text{ V}$

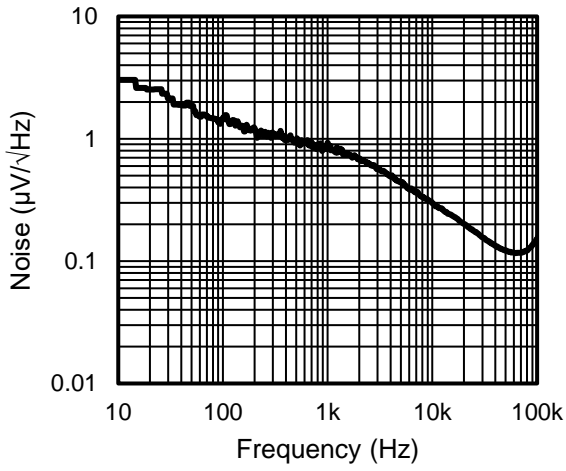

$V_{OUT} = 3.3 \text{ V}$

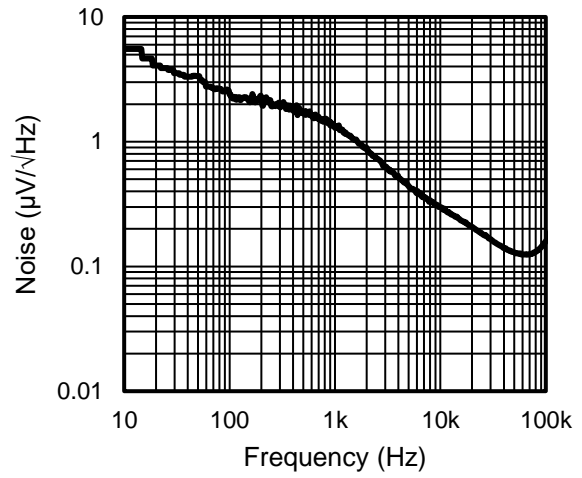

$V_{OUT} = 5.0 \text{ V}$

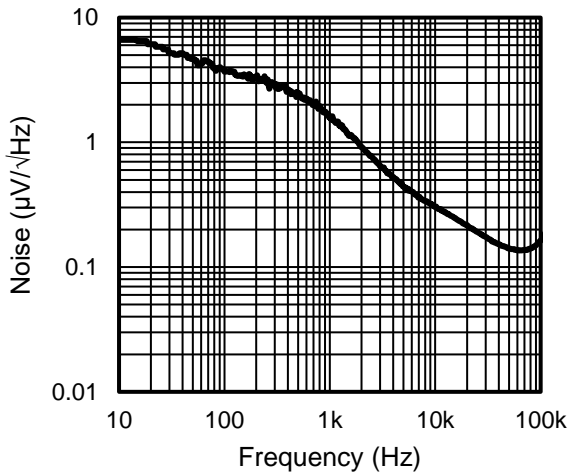



### 10.10. $t_{ON}$ Response

( $C_{IN} = 0.47 \mu\text{F}$ ,  $C_{OUT} = 0.47 \mu\text{F}$ ,  $I_{OUT} = \text{No load}$ ,  $T_a = 25 \text{ }^\circ\text{C}$ )

$V_{OUT} = 1.8 \text{ V}$  ( $V_{IN} = 4.0 \text{ V}$ )

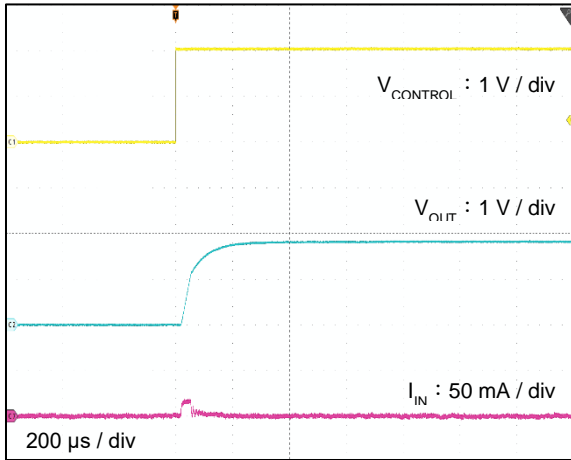

$V_{OUT} = 1.8 \text{ V}$  ( $V_{IN} = 24.0 \text{ V}$ )

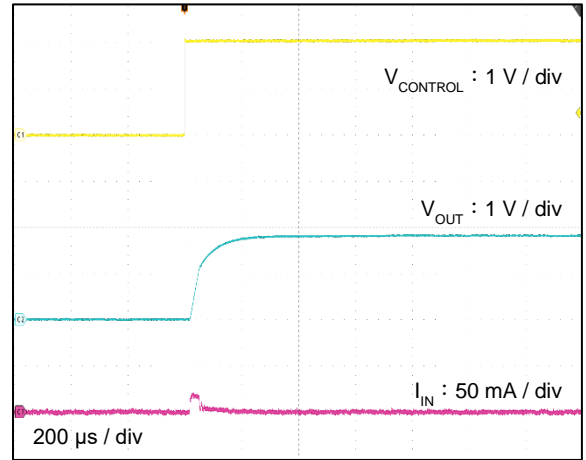

$V_{OUT} = 3.3 \text{ V}$  ( $V_{IN} = 4.3 \text{ V}$ )

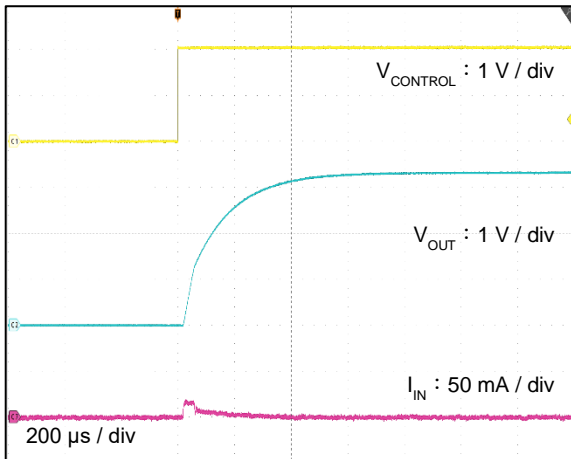

$V_{OUT} = 3.3 \text{ V}$  ( $V_{IN} = 24.0 \text{ V}$ )

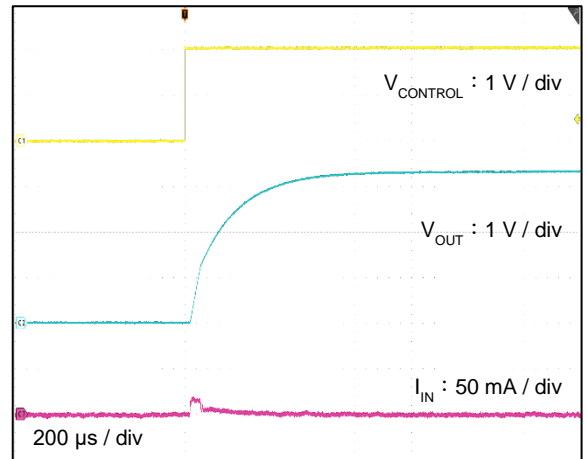

$V_{OUT} = 5.0 \text{ V}$  ( $V_{IN} = 6.0 \text{ V}$ )

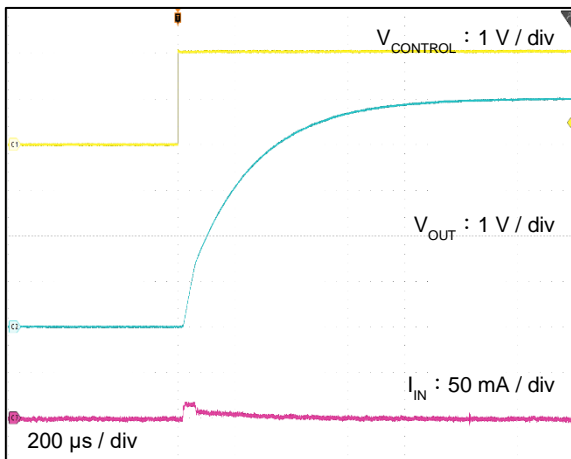

$V_{OUT} = 5.0 \text{ V}$  ( $V_{IN} = 24.0 \text{ V}$ )

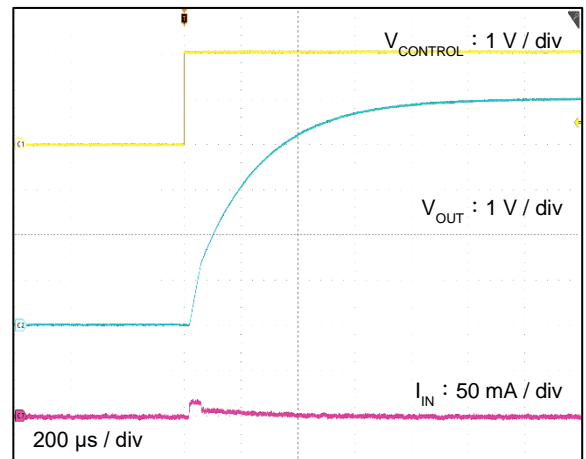

### 10.11. $t_{ON}$ / $t_{OFF}$ Response

( $C_{IN} = 0.47 \mu\text{F}$ ,  $C_{OUT} = 0.47 \mu\text{F}$ ,  $I_{OUT} = 1 \text{ mA}$ ,  $T_a = 25 \text{ }^\circ\text{C}$ )

$V_{OUT} = 1.8 \text{ V}$  ( $V_{IN} = 4.0 \text{ V}$ )

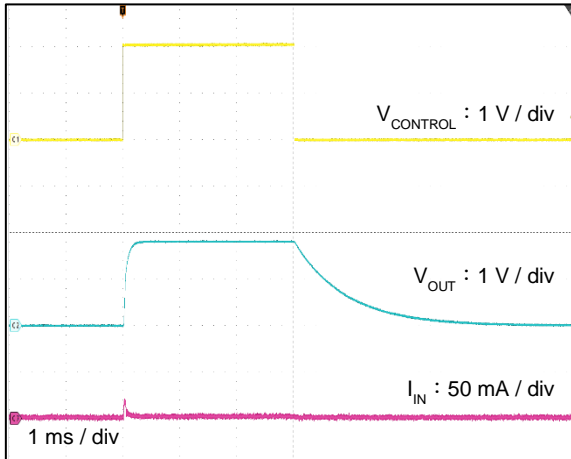

$V_{OUT} = 1.8 \text{ V}$  ( $V_{IN} = 24.0 \text{ V}$ )

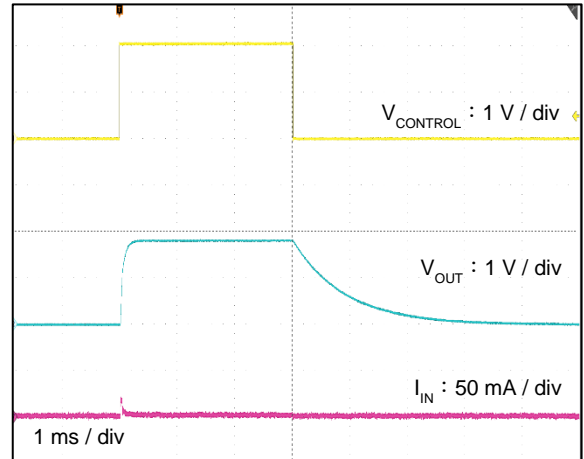

$V_{OUT} = 3.3 \text{ V}$  ( $V_{IN} = 4.3 \text{ V}$ )

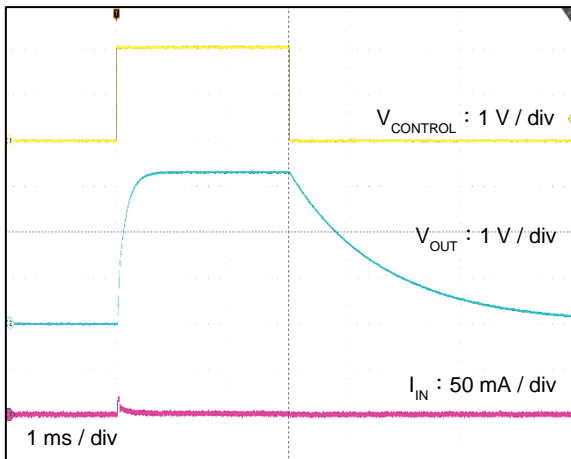

$V_{OUT} = 3.3 \text{ V}$  ( $V_{IN} = 24.0 \text{ V}$ )

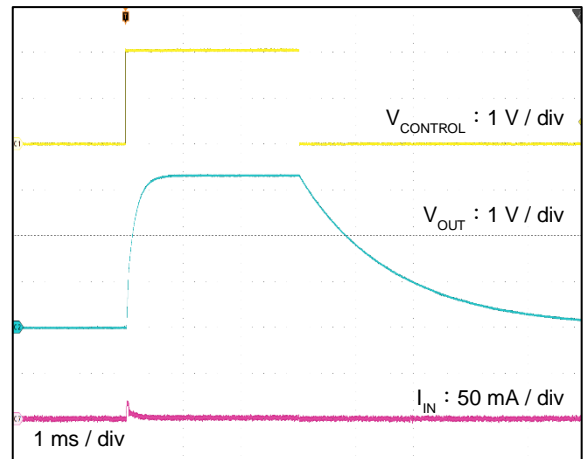

$V_{OUT} = 5.0 \text{ V}$  ( $V_{IN} = 6.0 \text{ V}$ )

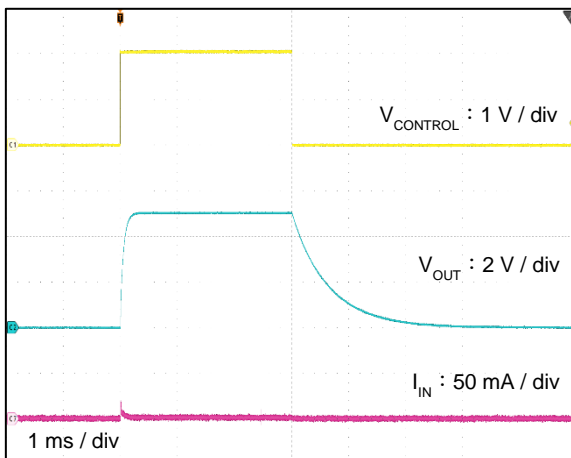

$V_{OUT} = 5.0 \text{ V}$  ( $V_{IN} = 24.0 \text{ V}$ )

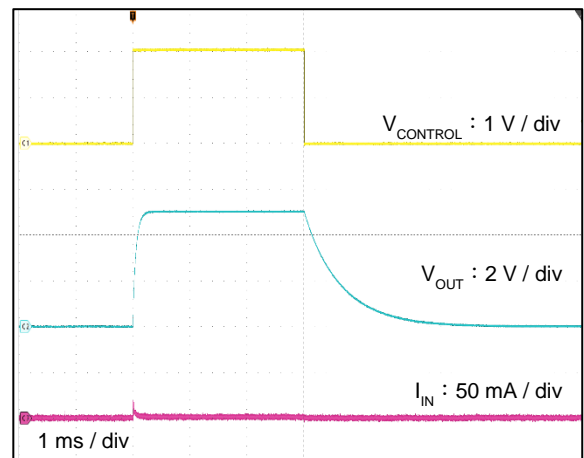

### 10.12. Load Transient Response

( $C_{IN} = 0.47 \mu\text{F}$ ,  $C_{OUT} = 0.47 \mu\text{F}$ ,  $T_a = 25 \text{ }^\circ\text{C}$ )

$V_{OUT} = 1.8 \text{ V}$   
( $V_{IN} = 4.0 \text{ V}$ ,  $I_{OUT} = 0 \text{ mA} \leftrightarrow 10 \text{ mA}$  at  $1 \mu\text{s}$ )

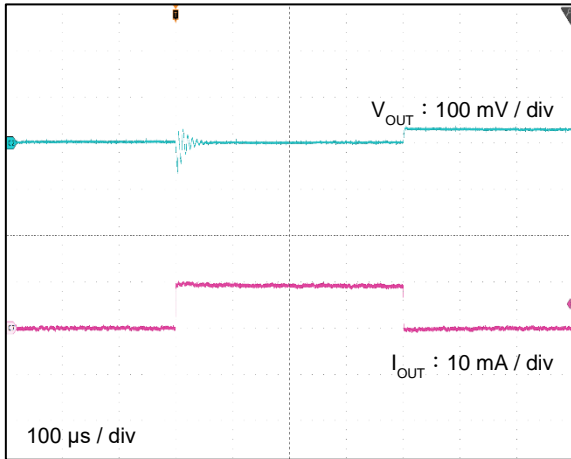

$V_{OUT} = 1.8 \text{ V}$   
( $V_{IN} = 4.0 \text{ V}$ ,  $I_{OUT} = 1 \text{ mA} \leftrightarrow 150 \text{ mA}$  at  $1 \mu\text{s}$ )

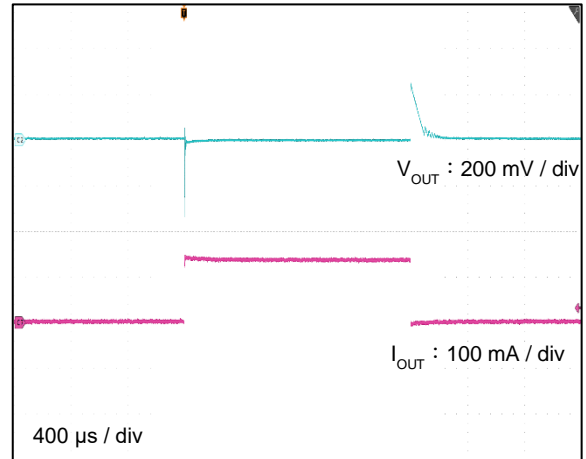

$V_{OUT} = 3.3 \text{ V}$   
( $V_{IN} = 4.3 \text{ V}$ ,  $I_{OUT} = 0 \text{ mA} \leftrightarrow 10 \text{ mA}$  at  $1 \mu\text{s}$ )

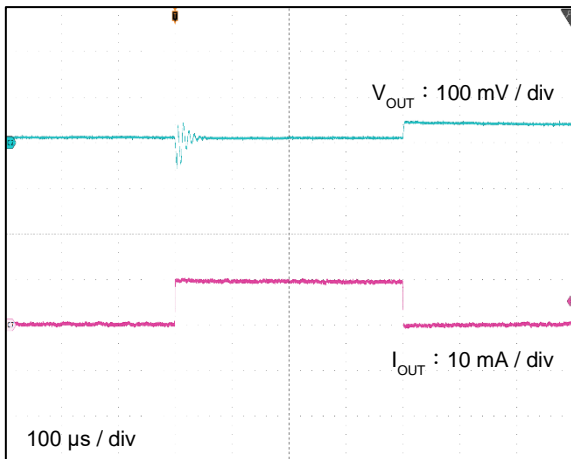

$V_{OUT} = 3.3 \text{ V}$   
( $V_{IN} = 4.3 \text{ V}$ ,  $I_{OUT} = 1 \text{ mA} \leftrightarrow 150 \text{ mA}$  at  $1 \mu\text{s}$ )

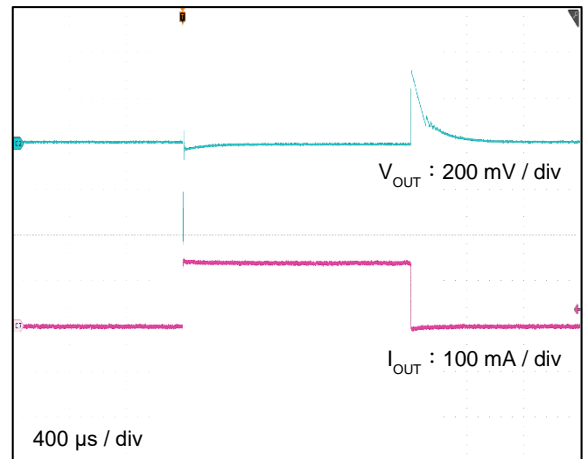

$V_{OUT} = 5.0 \text{ V}$   
( $V_{IN} = 6.0 \text{ V}$ ,  $I_{OUT} = 0 \text{ mA} \leftrightarrow 10 \text{ mA}$  at  $1 \mu\text{s}$ )

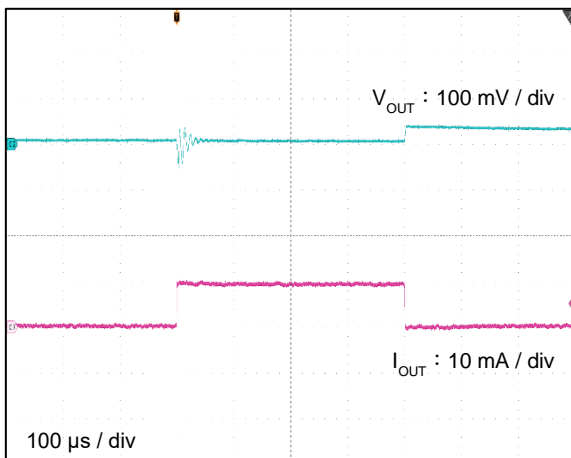

$V_{OUT} = 5.0 \text{ V}$   
( $V_{IN} = 6.0 \text{ V}$ ,  $I_{OUT} = 1 \text{ mA} \leftrightarrow 150 \text{ mA}$  at  $1 \mu\text{s}$ )

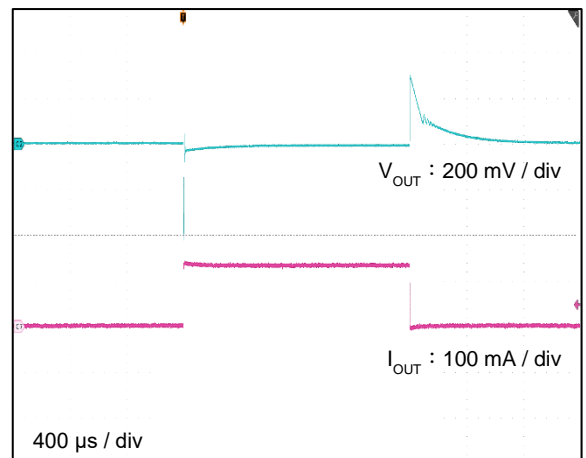

### 10.13. Line Transient Response

( $C_{IN} = 0.47 \mu\text{F}$ ,  $C_{OUT} = 0.47 \mu\text{F}$ ,  $T_a = 25 \text{ }^\circ\text{C}$ )

$V_{OUT} = 1.8 \text{ V}$   
 ( $V_{IN} = 4 \text{ V} \leftrightarrow 20 \text{ V}$ ),  $I_{OUT} = 1 \text{ mA}$

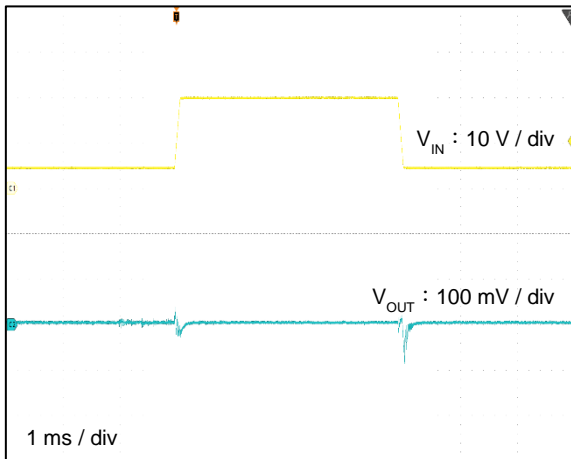

$V_{OUT} = 3.3 \text{ V}$   
 ( $V_{IN} = 4.3 \text{ V} \leftrightarrow 20 \text{ V}$ ),  $I_{OUT} = 1 \text{ mA}$

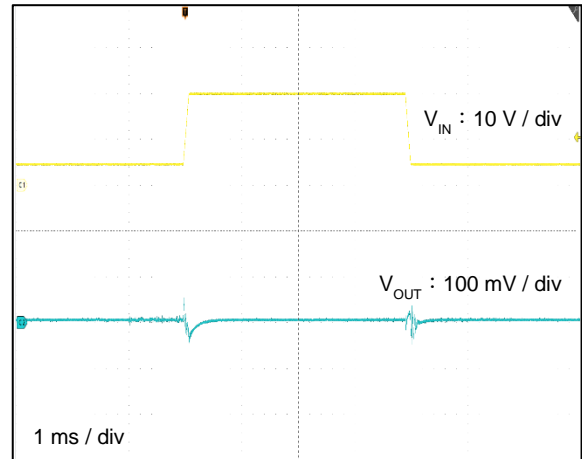

$V_{OUT} = 5.0 \text{ V}$   
 ( $V_{IN} = 6 \text{ V} \leftrightarrow 20 \text{ V}$ ),  $I_{OUT} = 1 \text{ mA}$

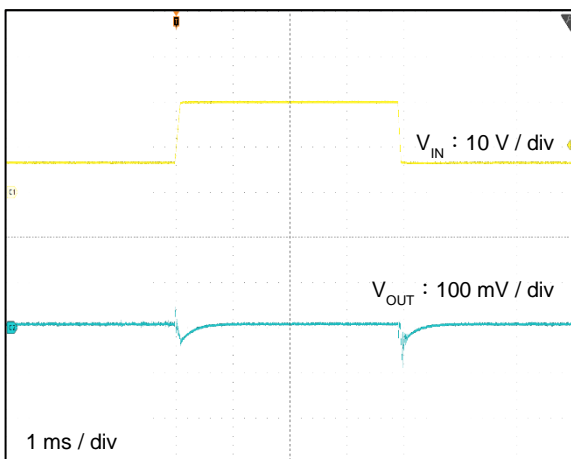

### 11. Package Information

SMV (SOT-25) (SC-74A)

Unit: mm

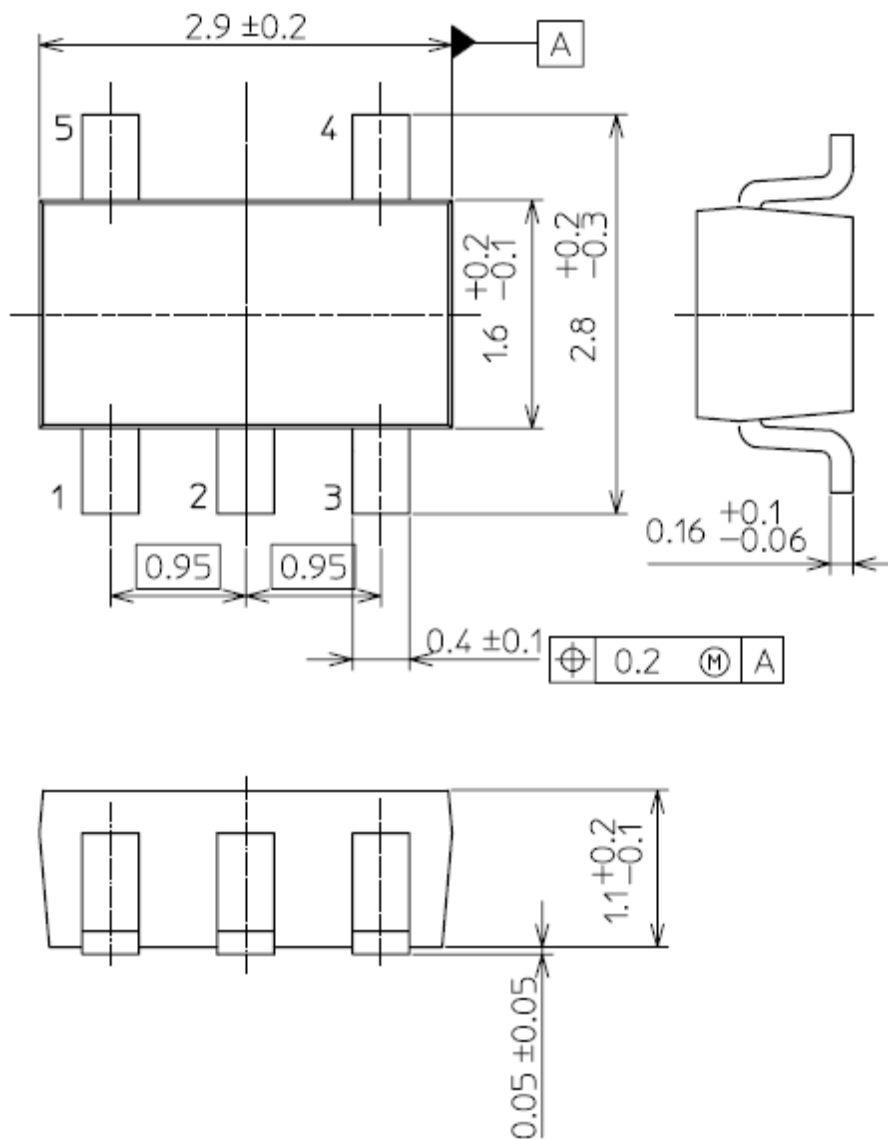

Weight: 16 mg (Typ.)

## RESTRICTIONS ON PRODUCT USE

Toshiba Corporation and its subsidiaries and affiliates are collectively referred to as "TOSHIBA". Hardware, software and systems described in this document are collectively referred to as "Product".

- TOSHIBA reserves the right to make changes to the information in this document and related Product without notice.
- This document and any information herein may not be reproduced without prior written permission from TOSHIBA. Even with TOSHIBA's written permission, reproduction is permissible only if reproduction is without alteration/omission.
- Though TOSHIBA works continually to improve Product's quality and reliability, Product can malfunction or fail. Customers are responsible for complying with safety standards and for providing adequate designs and safeguards for their hardware, software and systems which minimize risk and avoid situations in which a malfunction or failure of Product could cause loss of human life, bodily injury or damage to property, including data loss or corruption. Before customers use the Product, create designs including the Product, or incorporate the Product into their own applications, customers must also refer to and comply with (a) the latest versions of all relevant TOSHIBA information, including without limitation, this document, the specifications, the data sheets and application notes for Product and the precautions and conditions set forth in the "TOSHIBA Semiconductor Reliability Handbook" and (b) the instructions for the application with which the Product will be used with or for. Customers are solely responsible for all aspects of their own product design or applications, including but not limited to (a) determining the appropriateness of the use of this Product in such design or applications; (b) evaluating and determining the applicability of any information contained in this document, or in charts, diagrams, programs, algorithms, sample application circuits, or any other referenced documents; and (c) validating all operating parameters for such designs and applications. **TOSHIBA ASSUMES NO LIABILITY FOR CUSTOMERS' PRODUCT DESIGN OR APPLICATIONS.**
- **PRODUCT IS NEITHER INTENDED NOR WARRANTED FOR USE IN EQUIPMENTS OR SYSTEMS THAT REQUIRE EXTRAORDINARILY HIGH LEVELS OF QUALITY AND/OR RELIABILITY, AND/OR A MALFUNCTION OR FAILURE OF WHICH MAY CAUSE LOSS OF HUMAN LIFE, BODILY INJURY, SERIOUS PROPERTY DAMAGE AND/OR SERIOUS PUBLIC IMPACT ("UNINTENDED USE").** Except for specific applications as expressly stated in this document, Unintended Use includes, without limitation, equipment used in nuclear facilities, equipment used in the aerospace industry, lifesaving and/or life supporting medical equipment, equipment used for automobiles, trains, ships and other transportation, traffic signaling equipment, equipment used to control combustions or explosions, safety devices, elevators and escalators, and devices related to power plant. **IF YOU USE PRODUCT FOR UNINTENDED USE, TOSHIBA ASSUMES NO LIABILITY FOR PRODUCT.** For details, please contact your TOSHIBA sales representative or contact us via our website.
- Do not disassemble, analyze, reverse-engineer, alter, modify, translate or copy Product, whether in whole or in part.
- Product shall not be used for or incorporated into any products or systems whose manufacture, use, or sale is prohibited under any applicable laws or regulations.
- The information contained herein is presented only as guidance for Product use. No responsibility is assumed by TOSHIBA for any infringement of patents or any other intellectual property rights of third parties that may result from the use of Product. No license to any intellectual property right is granted by this document, whether express or implied, by estoppel or otherwise.
- **ABSENT A WRITTEN SIGNED AGREEMENT, EXCEPT AS PROVIDED IN THE RELEVANT TERMS AND CONDITIONS OF SALE FOR PRODUCT, AND TO THE MAXIMUM EXTENT ALLOWABLE BY LAW, TOSHIBA (1) ASSUMES NO LIABILITY WHATSOEVER, INCLUDING WITHOUT LIMITATION, INDIRECT, CONSEQUENTIAL, SPECIAL, OR INCIDENTAL DAMAGES OR LOSS, INCLUDING WITHOUT LIMITATION, LOSS OF PROFITS, LOSS OF OPPORTUNITIES, BUSINESS INTERRUPTION AND LOSS OF DATA, AND (2) DISCLAIMS ANY AND ALL EXPRESS OR IMPLIED WARRANTIES AND CONDITIONS RELATED TO SALE, USE OF PRODUCT, OR INFORMATION, INCLUDING WARRANTIES OR CONDITIONS OF MERCHANTABILITY, FITNESS FOR A PARTICULAR PURPOSE, ACCURACY OF INFORMATION, OR NONINFRINGEMENT.**
- Do not use or otherwise make available Product or related software or technology for any military purposes, including without limitation, for the design, development, use, stockpiling or manufacturing of nuclear, chemical, or biological weapons or missile technology products (mass destruction weapons). Product and related software and technology may be controlled under the applicable export laws and regulations including, without limitation, the Japanese Foreign Exchange and Foreign Trade Law and the U.S. Export Administration Regulations. Export and re-export of Product or related software or technology are strictly prohibited except in compliance with all applicable export laws and regulations.
- Please contact your TOSHIBA sales representative for details as to environmental matters such as the RoHS compatibility of Product. Please use Product in compliance with all applicable laws and regulations that regulate the inclusion or use of controlled substances, including without limitation, the EU RoHS Directive. **TOSHIBA ASSUMES NO LIABILITY FOR DAMAGES OR LOSSES OCCURRING AS A RESULT OF NONCOMPLIANCE WITH APPLICABLE LAWS AND REGULATIONS.**

## X-ON Electronics

Largest Supplier of Electrical and Electronic Components

*Click to view similar products for [LDO Voltage Regulators](#) category:*

*Click to view products by [Toshiba](#) manufacturer:*

Other Similar products are found below :

[AP7363-SP-13](#) [NCV8664CST33T3G](#) [L79M05TL-E](#) [AP7362-HA-7](#) [PT7M8202B12TA5EX](#) [TCR3DF185,LM\(CT](#) [TLF4949EJ](#)  
[NCP4687DH15T1G](#) [NCV8703MX30TCG](#) [LP2951CN](#) [NCV4269CPD50R2G](#) [AP7315-25W5-7](#) [NCV47411PAAJR2G](#) [AP2111H-1.2TRG1](#)  
[ZLDO1117QK50TC](#) [AZ1117ID-ADJTRG1](#) [NCV4263-2CPD50R2G](#) [NCP706ABMX300TAG](#) [NCP114BMX075TCG](#) [MC33269T-3.5G](#)  
[TLE4471GXT](#) [AP7315-33SA-7](#) [NCV4266-2CST33T3G](#) [NCP715SQ15T2G](#) [NCV8623MN-50R2G](#) [NCV563SQ18T1G](#) [NCV8664CDT33RKG](#)  
[NCV4299CD250R2G](#) [NCP715MX30TBG](#) [NCV8702MX25TCG](#) [TLE7270-2E](#) [NCV562SQ25T1G](#) [AP2213D-3.3TRG1](#) [AP2202K-2.6TRE1](#)  
[NCV8170BMX300TCG](#) [NCV8152MX300180TCG](#) [NCP700CMT45TBG](#) [AP7315-33W5-7](#) [NCP154MX180300TAG](#) [AP2113AMTR-G1](#)  
[NJW4104U2-33A-TE1](#) [MP2013AGG-5-P](#) [NCV8775CDT50RKG](#) [NJM2878F3-45-TE1](#) [S-19214B00A-V5T2U7](#) [S-19214B50A-V5T2U7](#) [S-](#)  
[19213B50A-V5T2U7](#) [S-19214BC0A-E8T1U7\\*1](#) [S-19213B00A-V5T2U7](#) [S-19213B33A-V5T2U7](#)