

TOSHIBA CMOS Linear Integrated Circuit Silicon Monolithic

# TCR2EN series

## 200 mA CMOS Low Drop-Out Regulator in ultra small package

The TCR2EN series are CMOS general-purpose single-output voltage regulators with an on/off control input, featuring low dropout voltage, low quiescent bias current and fast load transient response.

These voltage regulators are available in fixed output voltages between 1.0 V and 3.6 V and capable of driving up to 200 mA. They feature overcurrent protection and an Auto-discharge function.

The TCR2EN series is offered in the ultra small plastic mold package SDFN4 (0.8 mm x 0.8 mm x 0.38 mm). It has a low dropout voltage of 160 mV ( 2.5 V output,  $I_{OUT} = 150$  mA) with low output noise voltage of  $35 \mu V_{rms}$  (2.5 V output) and a load transient response of only  $\Delta V_{OUT} = \pm 55$  mV (  $I_{OUT} = 1$  mA  $\leftrightarrow$  150 mA,  $C_{OUT} = 1.0 \mu F$ ).

As small ceramic input and output capacitors can be used with the TCR2EN series, these devices are ideal for portable applications that require high-density board assembly such as cellular phones.

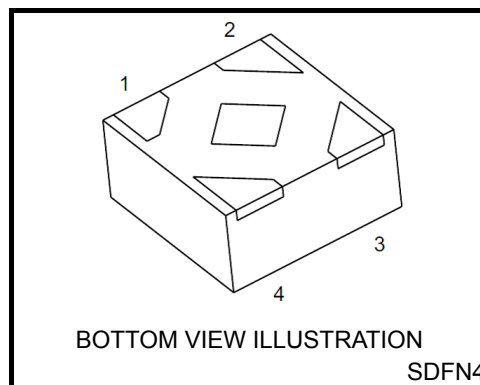

Weight: 0.6 mg (typ.)

## Features

- Low Drop-Out voltage
  - $V_{IN}-V_{OUT} = 160$  mV (typ.) at 2.5 V-output,  $I_{OUT} = 150$  mA
  - $V_{IN}-V_{OUT} = 210$  mV (typ.) at 1.8 V-output,  $I_{OUT} = 150$  mA
  - $V_{IN}-V_{OUT} = 360$  mV (typ.) at 1.2 V-output,  $I_{OUT} = 150$  mA
  - $V_{IN}-V_{OUT} = 490$  mV (typ.) at 1.0 V-output,  $I_{OUT} = 150$  mA
- Low output noise voltage
  - $V_{NO} = 35 \mu V_{rms}$  (typ.) at 2.5 V-output,  $I_{OUT} = 10$  mA,  $10 \text{ Hz} < f < 100 \text{ kHz}$
  - $V_{NO} = 30 \mu V_{rms}$  (typ.) at 1.8 V-output,  $I_{OUT} = 10$  mA,  $10 \text{ Hz} < f < 100 \text{ kHz}$
  - $V_{NO} = 23 \mu V_{rms}$  (typ.) at 1.2 V-output,  $I_{OUT} = 10$  mA,  $10 \text{ Hz} < f < 100 \text{ kHz}$
  - $V_{NO} = 18 \mu V_{rms}$  (typ.) at 1.0 V-output,  $I_{OUT} = 10$  mA,  $10 \text{ Hz} < f < 100 \text{ kHz}$
- Fast load transient response ( $\Delta V_{OUT} = \pm 55$  mV (typ.) at  $I_{OUT} = 1$  mA  $\leftrightarrow$  150 mA,  $C_{OUT} = 1.0 \mu F$  )
- Low quiescent bias current (  $I_B = 35 \mu A$  (typ.) at  $I_{OUT} = 0$  mA )
- High ripple rejection ( R.R = 73 dB (typ.) at 2.5 V-output,  $I_{OUT} = 10$  mA,  $f = 1$  kHz )
- Wide range Output Voltage line up (  $V_{OUT} = 1.0$  to 3.6 V )
- High  $V_{OUT}$  accuracy  $\pm 1.0\%$  (  $1.8 \text{ V} \leq V_{OUT}$  )
- Overcurrent protection
- Auto-discharge
- Pull down connection between CONTROL and GND
- Ceramic capacitors can be used (  $C_{IN} = 0.1 \mu F$ ,  $C_{OUT} = 1.0 \mu F$  )
- Ultra Small package SDFN4 (0.8 mm x 0.8 mm x 0.38 mm )

Start of commercial production  
2013-11

## Absolute Maximum Ratings (Ta = 25°C)

Characteristics	Symbol	Rating	Unit
Input voltage	$V_{IN}$	6.0	V
Control voltage	$V_{CT}$	-0.3 to 6.0	V
Output voltage	$V_{OUT}$	-0.3 to $V_{IN} + 0.3$	V
Output current	$I_{OUT}$	200	mA
Power dissipation	$P_D$	300 (Note1)	mW
Operation temperature range	$T_{opr}$	-40 to 85	°C
Junction temperature	$T_j$	150	°C
Storage temperature range	$T_{stg}$	-55 to 150	°C

Note: Using continuously under heavy loads (e.g. the application of high temperature/current/voltage and the significant change in temperature, etc.) may cause this product to decrease in the reliability significantly even if the operating conditions (i.e. operating temperature/current/voltage, etc.) are within the absolute maximum ratings and the operating ranges.

Please design the appropriate reliability upon reviewing the Toshiba Semiconductor Reliability Handbook ("Handling Precautions"/"Derating Concept and Methods") and individual reliability data (i.e. reliability test report and estimated failure rate, etc).

Note1: Rating at mounting on a board

Glass epoxy(FR4) board dimension: 40mm x 40mm x 1.6mm, both sides of board

Metal pattern ratio: a surface approximately 50%, the reverse side approximately 50%

Through hole: diameter 0.5mm x 24

## Pin Assignment (top view)

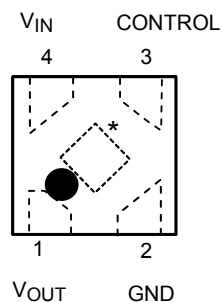

\*Center electrode should be connected to GND or Open

## List of Products Number, Output voltage and Marking

Product No.	Output voltage(V) (typ.)	Marking	Product No.	Output voltage(V) (typ.)	Marking
TCR2EN10	1.0	NJ	TCR2EN27	2.7	NO
TCR2EN105	1.05	NU	TCR2EN28	2.8	NP
TCR2EN11	1.1	N2	TCR2EN285	2.85	N7
TCR2EN115	1.15	NC	TCR2EN29	2.9	NR
TCR2EN12	1.2	N3	TCR2EN30	3.0	NS
TCR2EN125	1.25	NQ	TCR2EN31	3.1	NT
TCR2EN13	1.3	N4	TCR2EN32	3.2	NV
TCR2EN15	1.5	NA	TCR2EN33	3.3	NW
TCR2EN18	1.8	NE	TCR2EN34	3.4	NX
TCR2EN19	1.9	NF	TCR2EN35	3.5	NY
TCR2EN21	2.1	NH	TCR2EN36	3.6	NZ
TCR2EN25	2.5	NM			

Please ask your local retailer about the devices with other output voltages.

## Marking (top view)

Example: TCR2EN33 (3.3 V output)

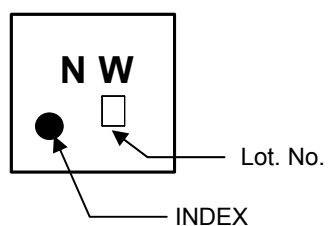

## Electrical Characteristics

(Unless otherwise specified,

$V_{IN} = V_{OUT} + 1\text{ V}$ ,  $I_{OUT} = 50\text{ mA}$ ,  $C_{IN} = 0.1\text{ }\mu\text{F}$ ,  $C_{OUT} = 1.0\text{ }\mu\text{F}$ ,  $T_j = 25^\circ\text{C}$ )

Characteristics	Symbol	Test Condition	Min	Typ.	Max	Unit	
Output voltage accuracy	$V_{OUT}$	$I_{OUT} = 50\text{ mA}$ (Note2)	$V_{OUT} < 1.8\text{ V}$	-18	—	+18	mV
			$1.8\text{ V} \leq V_{OUT}$	-1.0	—	+1.0	%
Input voltage	$V_{IN}$	$I_{OUT} = 1\text{ mA}$	1.5	—	5.5	V	
Line regulation	Reg·line	$V_{OUT} + 0.5\text{ V} \leq V_{IN} \leq 5.5\text{ V}$ , $I_{OUT} = 1\text{ mA}$	—	1	15	mV	
Load regulation	Reg·load	$1\text{ mA} \leq I_{OUT} \leq 150\text{ mA}$	—	15	30	mV	
Quiescent current	$I_B$	$I_{OUT} = 0\text{ mA}$	—	35	60	$\mu\text{A}$	
Stand-by current	$I_B$ (OFF)	$V_{CT} = 0\text{ V}$	—	0.1	1.0	$\mu\text{A}$	
Drop-out voltage	$V_{IN} - V_{OUT}$	$I_{OUT} = 150\text{ mA}$ (Note 3)	—	160	210	mV	
Temperature coefficient	$T_{CVO}$	$-40^\circ\text{C} \leq T_{opr} \leq 85^\circ\text{C}$	—	75	—	ppm/ $^\circ\text{C}$	
Output noise voltage	$V_{NO}$	$V_{IN} = V_{OUT} + 1\text{ V}$ , $I_{OUT} = 10\text{ mA}$ , $10\text{ Hz} \leq f \leq 100\text{ kHz}$ , $T_a = 25^\circ\text{C}$ (Note 3)	—	35	—	$\mu\text{V}_{rms}$	
Ripple rejection ratio	R.R.	$V_{IN} = V_{OUT} + 1\text{ V}$ , $I_{OUT} = 10\text{ mA}$ , $f = 1\text{ kHz}$ , $V_{Ripple} = 500\text{ mV}_{p-p}$ , $T_a = 25^\circ\text{C}$ (Note 3)	—	73	—	dB	
Load transient response	$\Delta V_{OUT}$	$I_{OUT} = 1\text{ mA} \Leftrightarrow 150\text{ mA}$ , $C_{OUT} = 1.0\text{ }\mu\text{F}$	—	$\pm 55$	—	mV	
Control voltage (ON)	$V_{CT}$ (ON)	—	1.0	—	5.5	V	
Control voltage (OFF)	$V_{CT}$ (OFF)	—	0	—	0.4	V	

Note 2: Stable state with fixed  $I_{OUT}$  condition

Note 3: The 2.5 V output product

## Drop-out voltage for different output voltages

( $I_{OUT} = 150\text{ mA}$ ,  $C_{IN} = 0.1\text{ }\mu\text{F}$ ,  $C_{OUT} = 1.0\text{ }\mu\text{F}$ ,  $T_j = 25^\circ\text{C}$ )

Output voltages	Symbol	Min	Typ.	Max	Unit
1.0 V, 1.05 V	$V_{IN} - V_{OUT}$	—	490	750	mV
1.1 V, 1.15 V		—	420	650	
1.2 V, 1.25 V		—	360	550	
1.3 V		—	330	450	
1.4 V		—	290	400	
$1.5\text{ V} \leq V_{OUT} < 1.8\text{ V}$		—	270	370	
$1.8\text{ V} \leq V_{OUT} < 2.5\text{ V}$		—	210	290	
$2.5\text{ V} \leq V_{OUT} < 3.0\text{ V}$		—	160	210	
$3.0\text{ V} \leq V_{OUT} \leq 3.6\text{ V}$		—	130	180	

## Application Note

### 1. Recommended Application Circuit

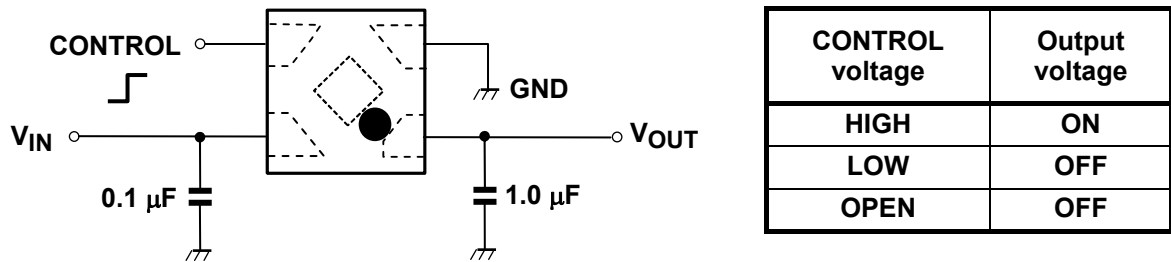

The figure above shows the recommended configuration for using a Low-Dropout regulator. Insert a capacitor at  $V_{OUT}$  and  $V_{IN}$  pins for stable input/output operation. (Ceramic capacitors can be used).

### 2. Power Dissipation

Power dissipation is measured on the board condition shown below.

[The Board Condition]

Board material: Glass epoxy(FR4)

Board dimension: 40mm x 40mm (both sides of board),  $t=1.6\text{mm}$

Metal pattern ratio: a surface approximately 50%, the reverse side approximately 50%

Through hole: diameter 0.5mm x 24

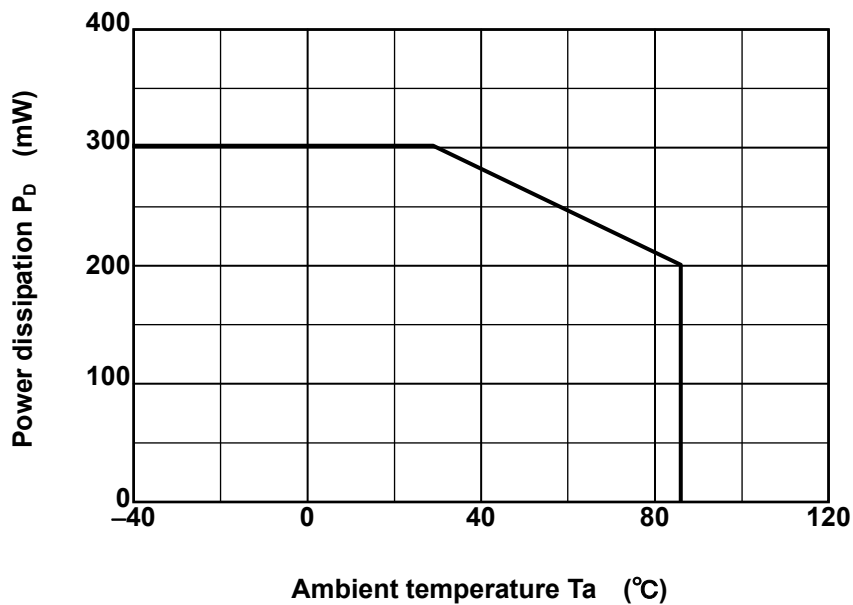

## Usage Considerations

- **Output Capacitors**  
Ceramic capacitors can be used for these devices. However, because of the type of the capacitors, there might be unexpected thermal features. Please consider application condition for selecting capacitors. And Toshiba recommend the ESR of ceramic capacitor is under 10  $\Omega$ .
- **Mounting**  
The long distance between IC and output capacitor might affect phase assurance by impedance in wire and inductor. For stable power supply, output capacitor need to mount near IC as much as possible. Also VIN and GND pattern need to be large and make the wire impedance small as possible.
- **Permissible Loss**  
Please have enough design patterns for expected maximum permissible loss. And under consideration of surrounding temperature, input voltage, and output current etc, we recommend proper dissipation ratings for maximum permissible loss; in general maximum dissipation rating is 70 to 80 percent.
- **Overcurrent Protection Circuit**  
Overcurrent protection circuit is designed in these products, but this does not assure for the suppression of uprising device operation. If output pins and GND pins are shorted out, these products might be break down. In use of these products, please read through and understand dissipation idea for absolute maximum ratings from the above mention or our 'Semiconductor Reliability Handbook'. Then use these products under absolute maximum ratings in any condition. Furthermore, Toshiba recommend inserting failsafe system into the design.

**Representative Typical Characteristics**

**1) Output Voltage vs. Input Voltage**

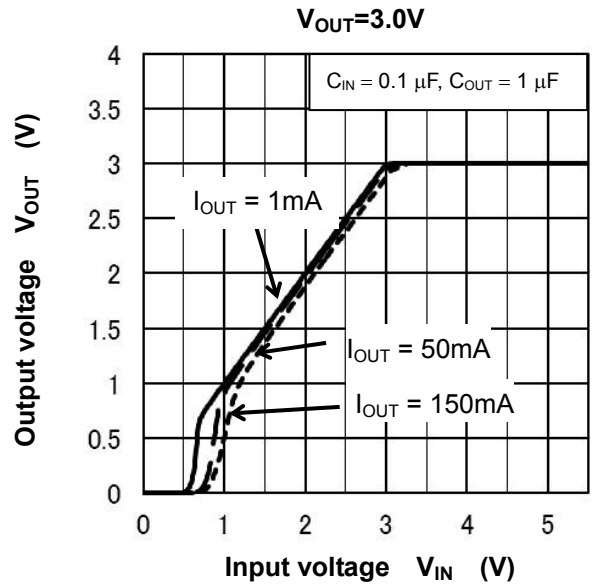
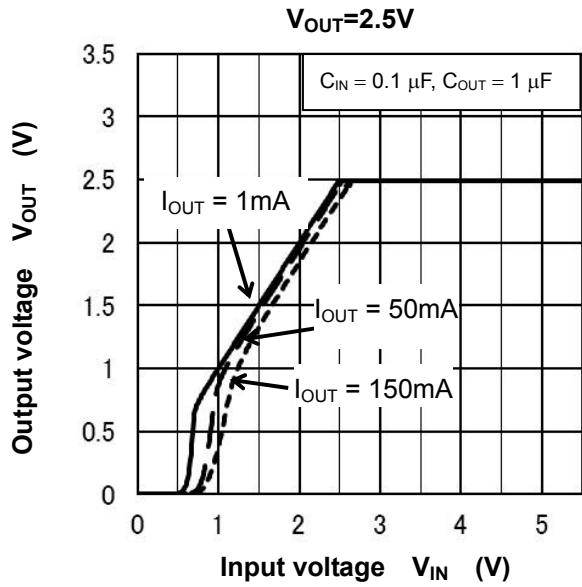
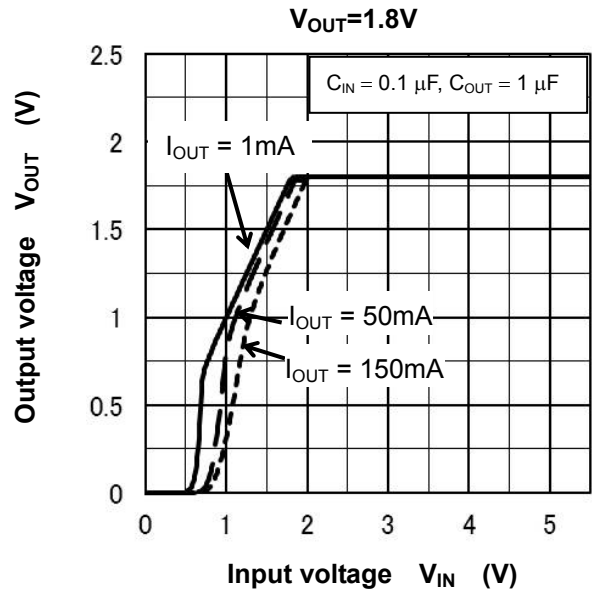
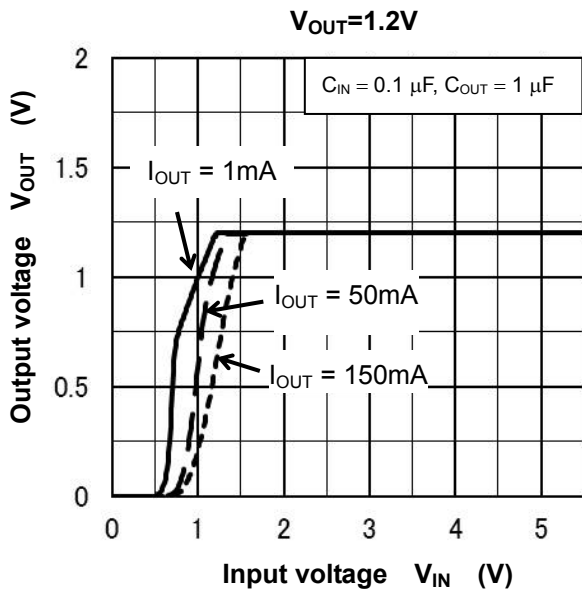

**2) Output Voltage vs. Output Current**

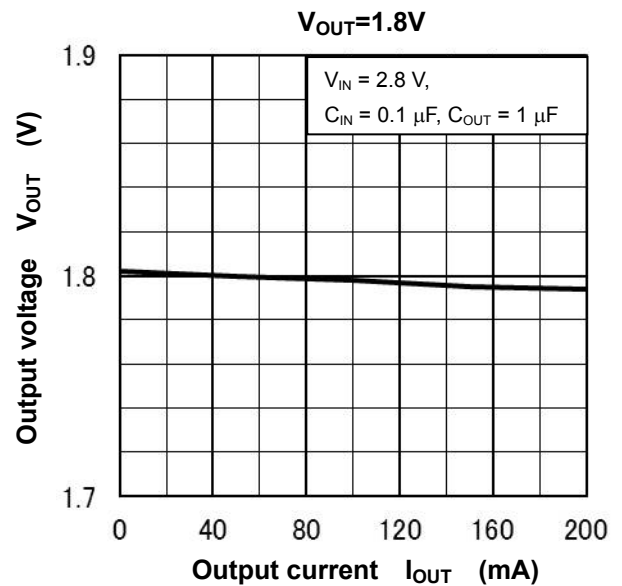
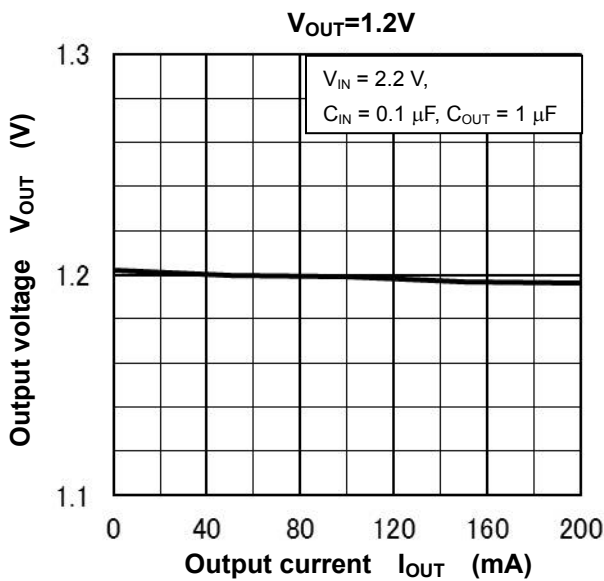

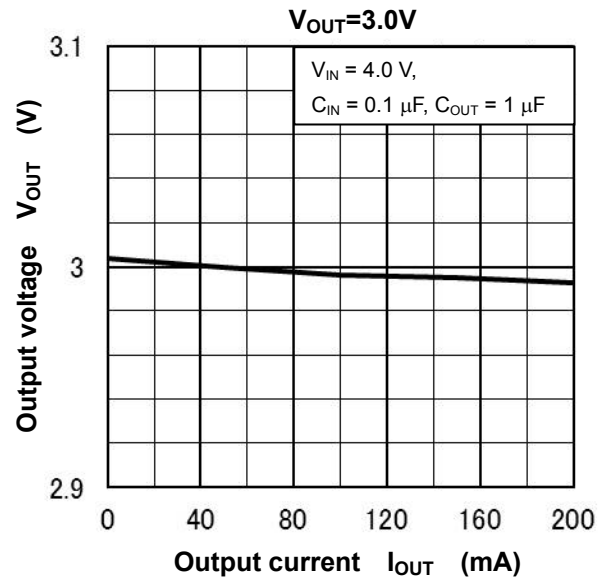
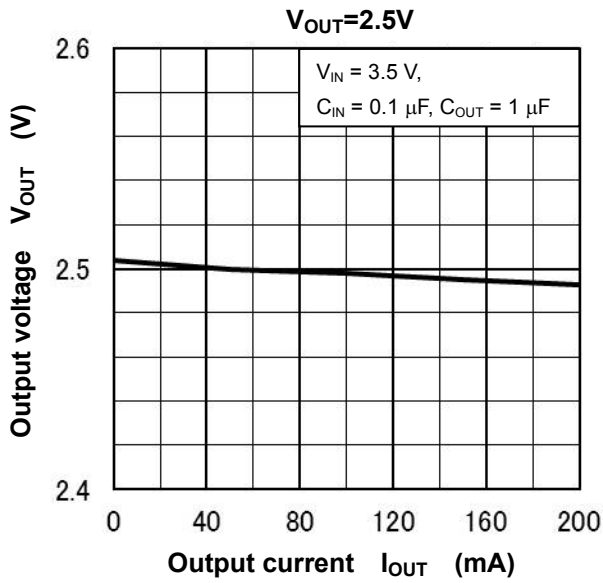

**3) Output Voltage vs. Ambient Temperature**

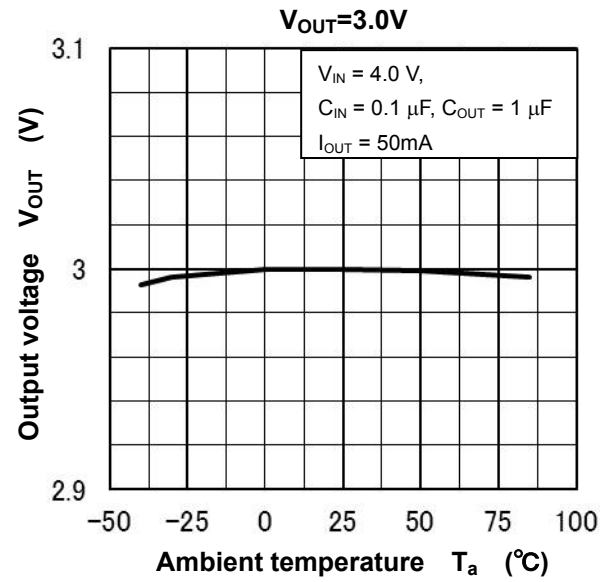
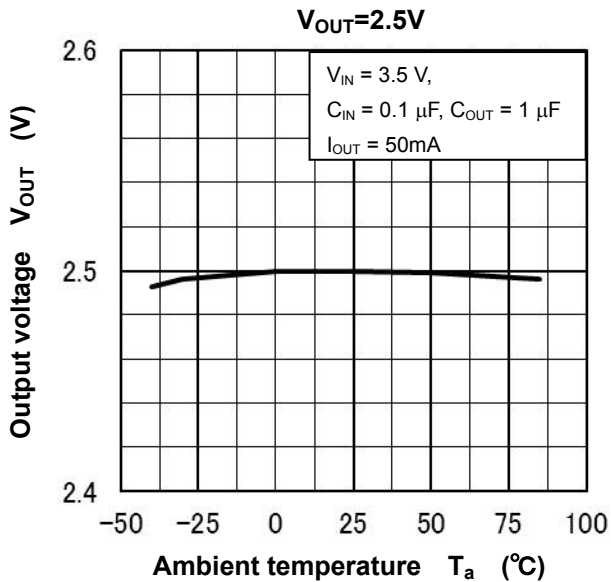
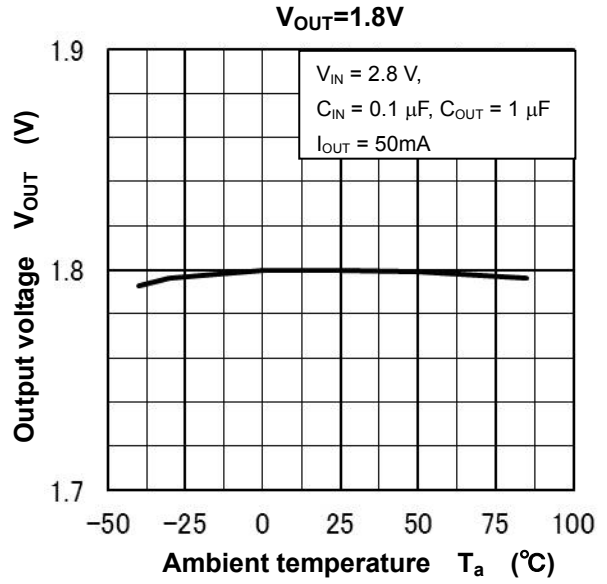
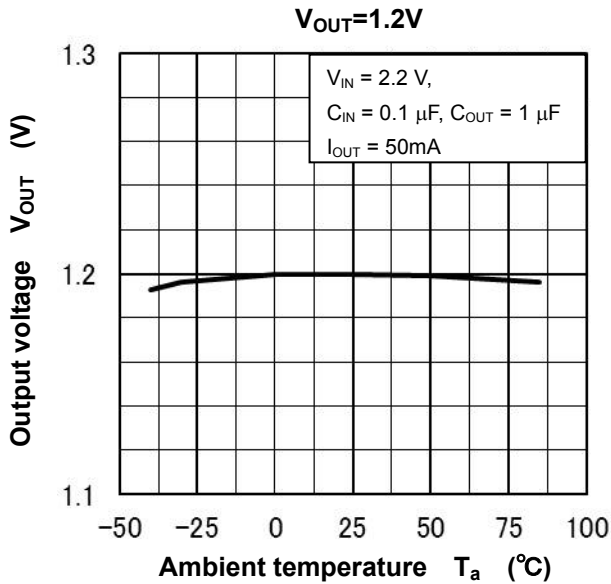



4) Dropout Voltage vs. Output Current

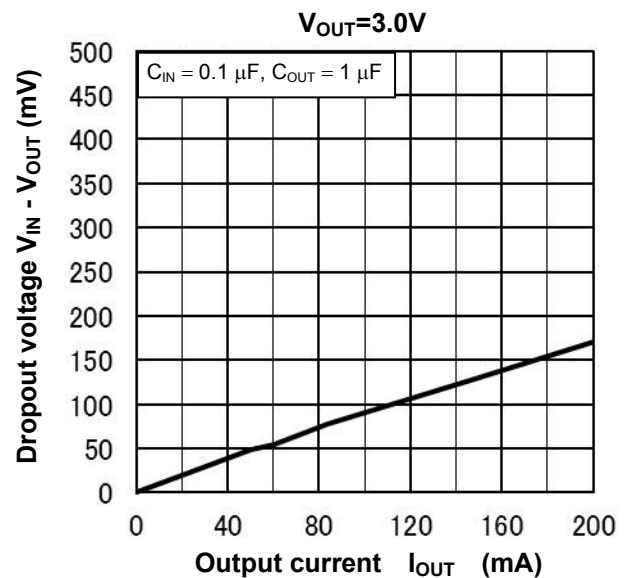
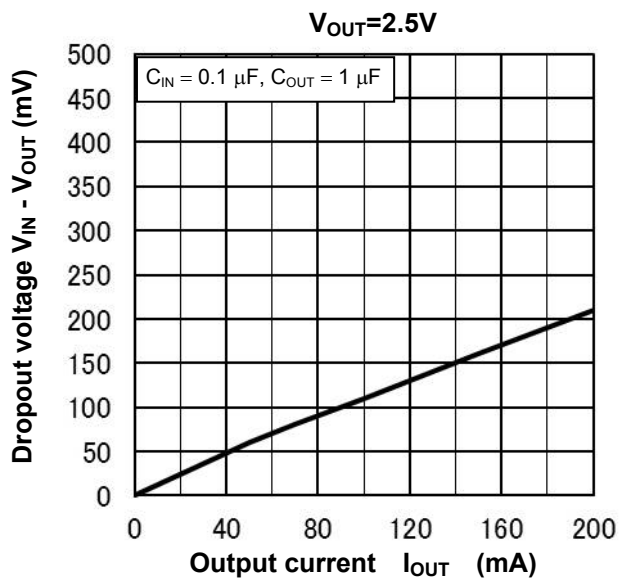
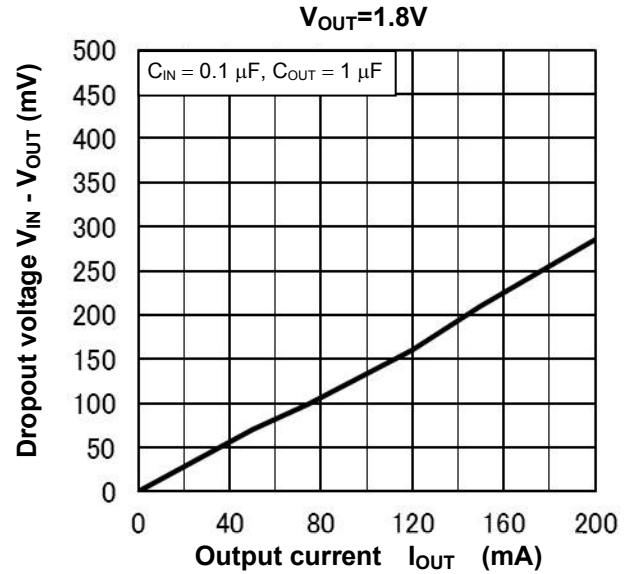
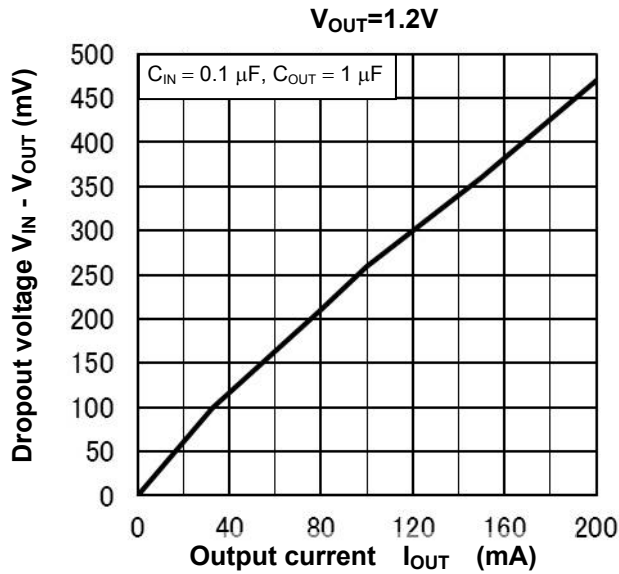

5) Quiescent Current vs. Input Voltage

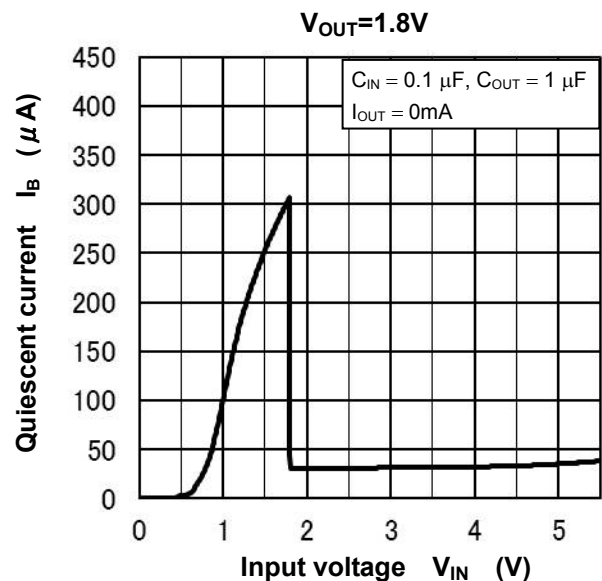
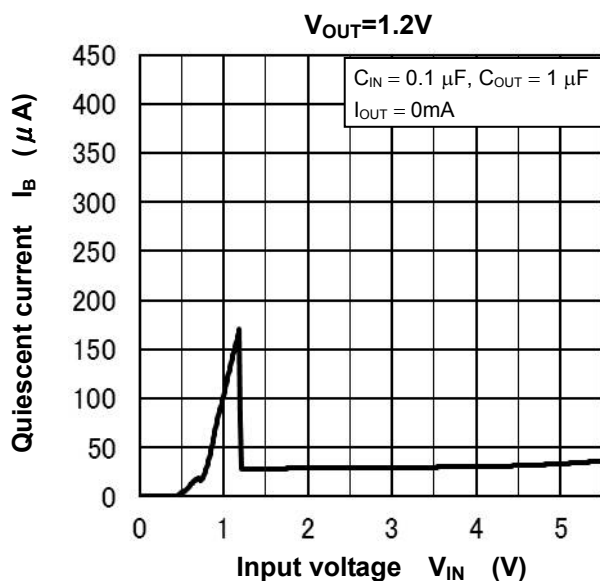

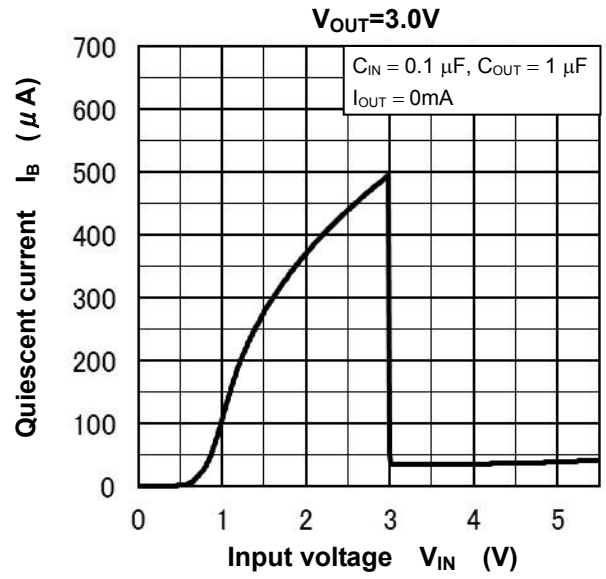
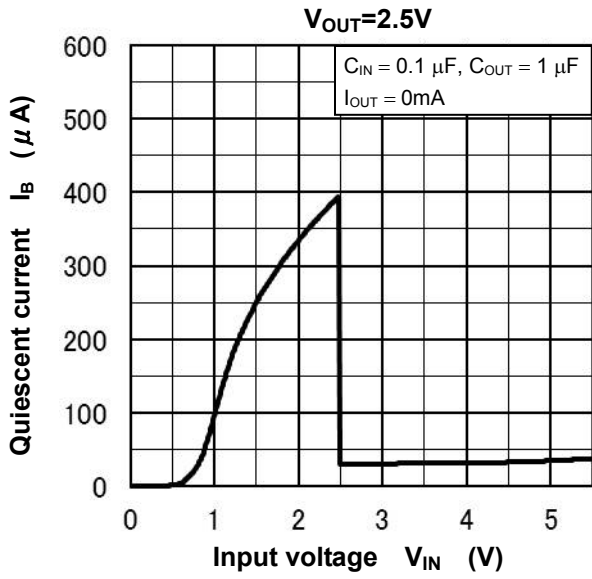

6) Quiescent Current vs. Ambient Temperature

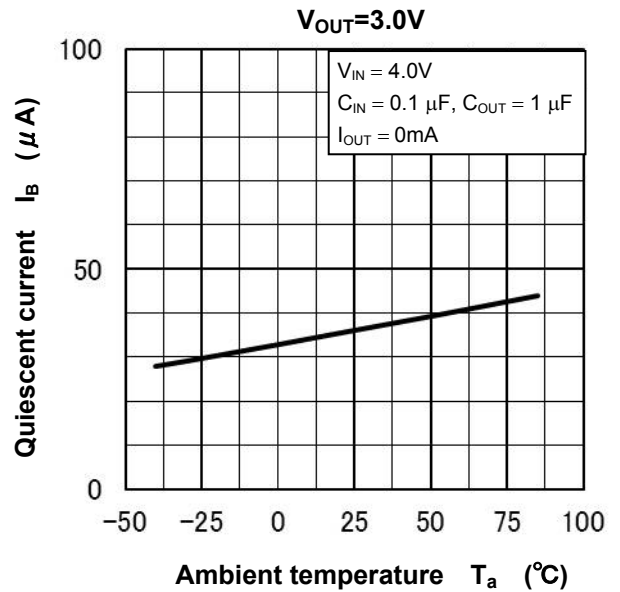
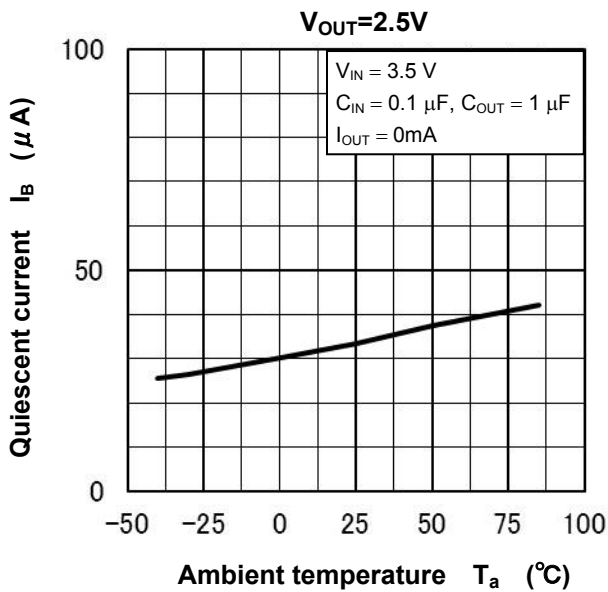
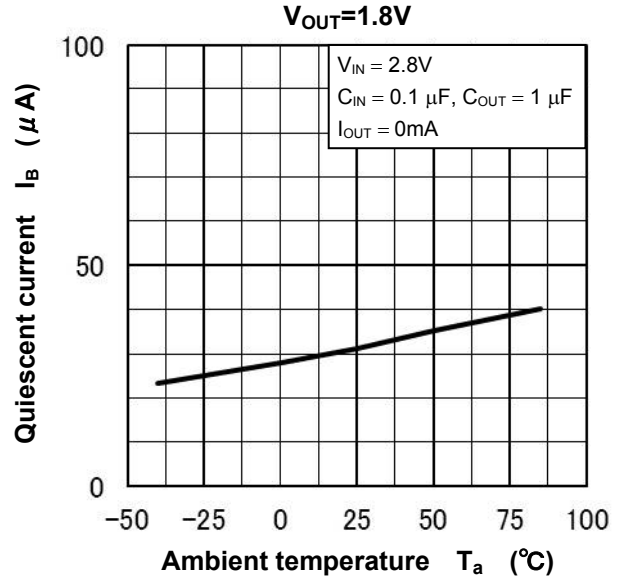
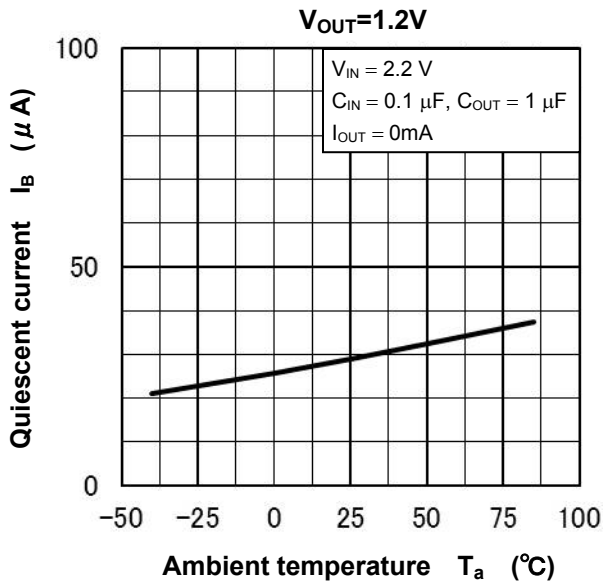

7) Output Voltage vs. Output Current

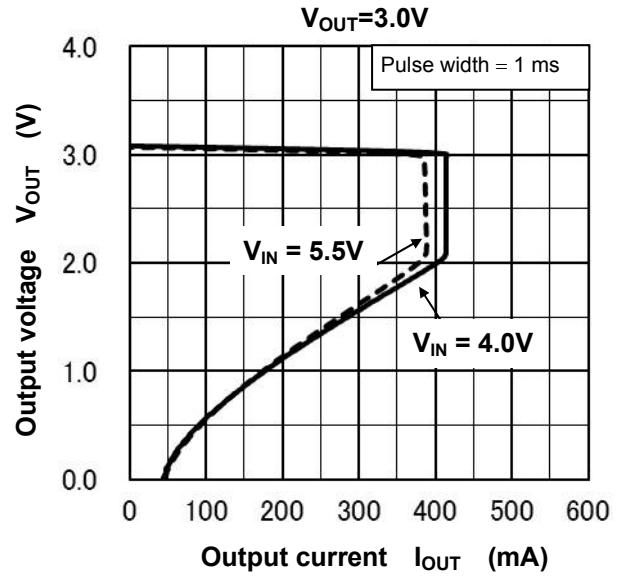
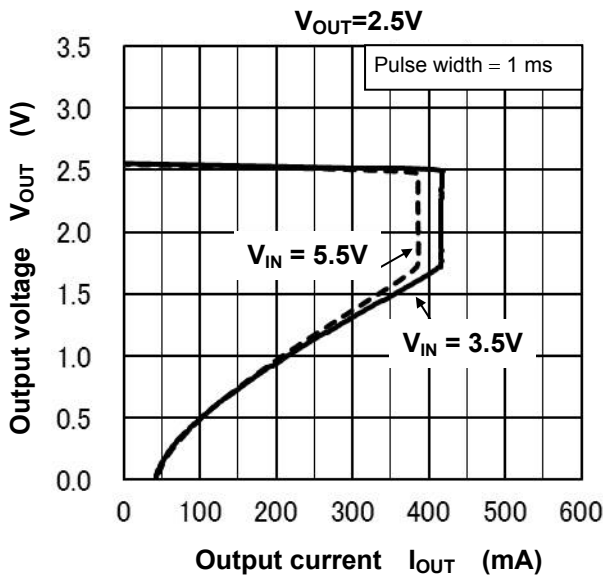
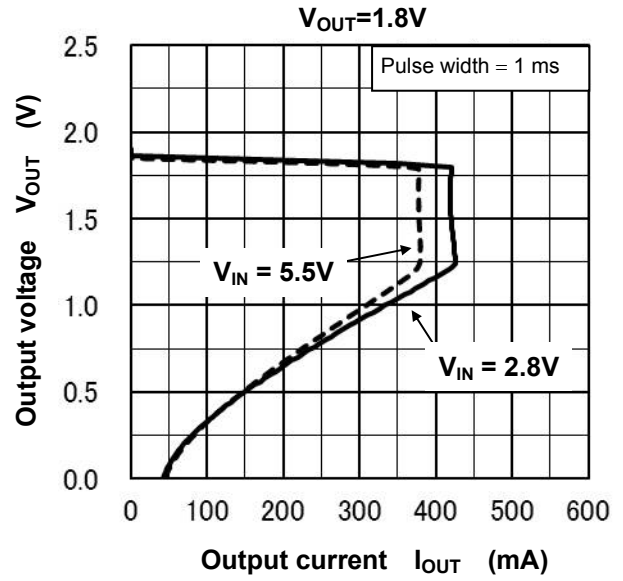
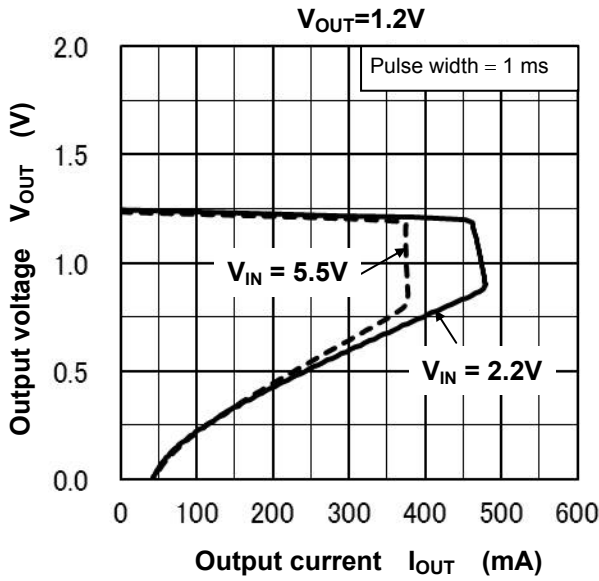

8) Ripple Rejection Ratio vs. Frequency

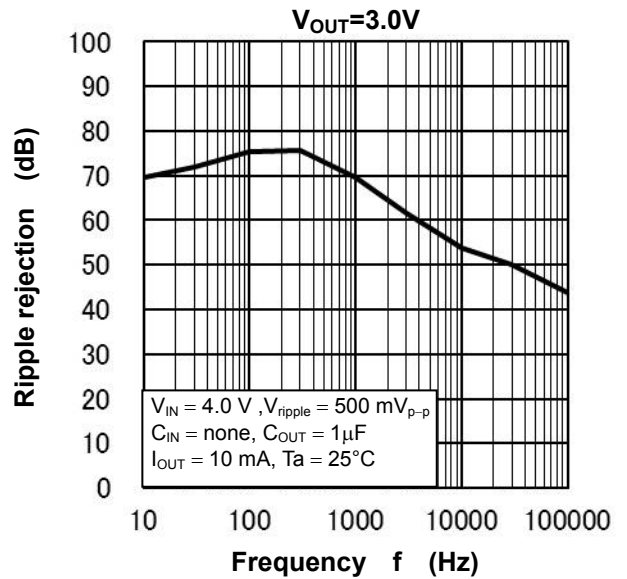
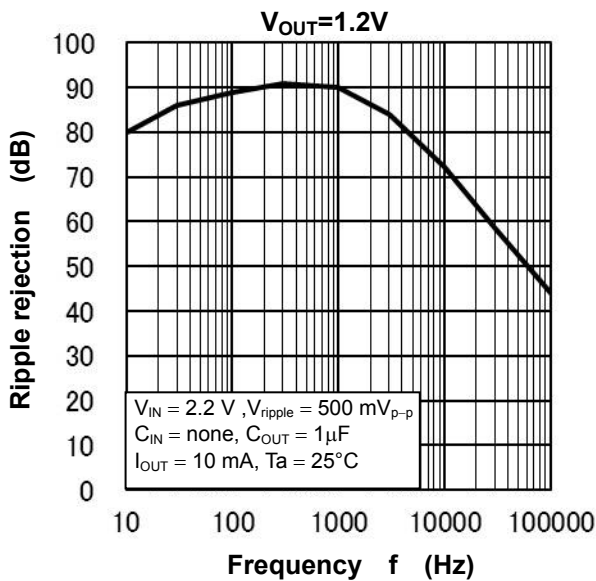

9) Control Transient Response

**V<sub>OUT</sub>=1.2V**

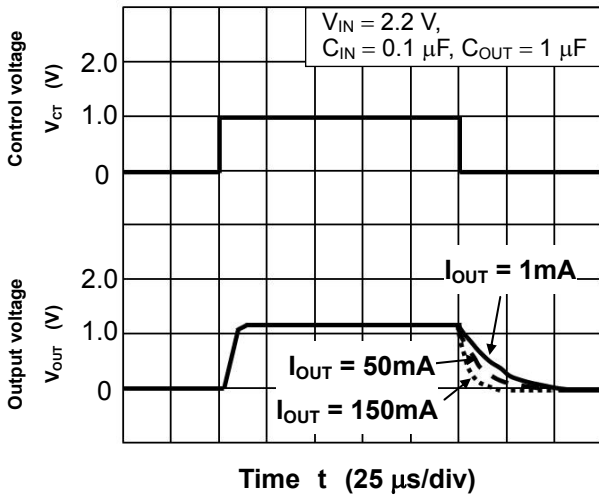

**V<sub>OUT</sub>=1.8V**

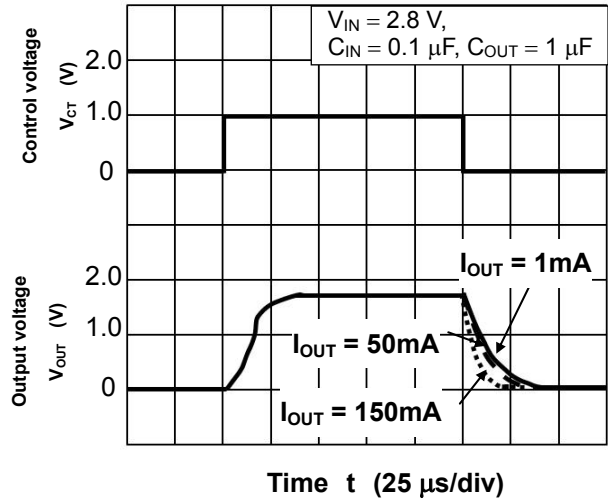

**V<sub>OUT</sub>=2.5V**

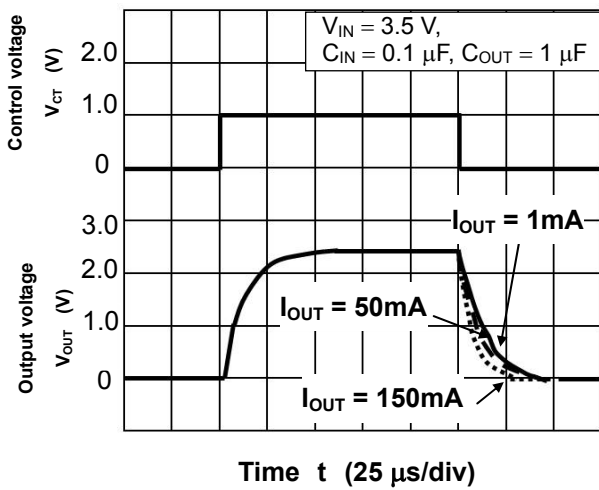

**V<sub>OUT</sub>=3.0V**

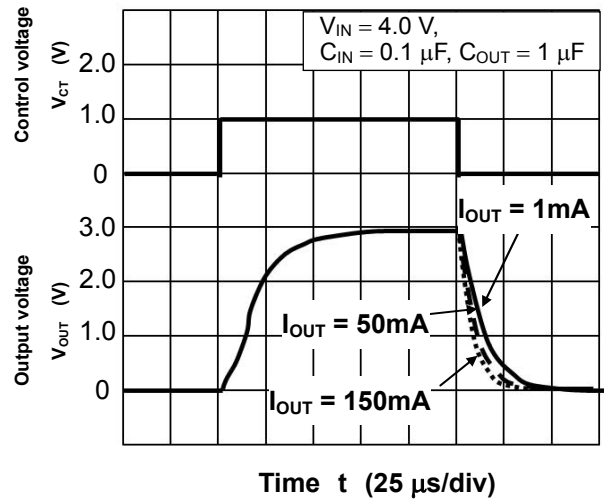

## 10) Load Transient Response

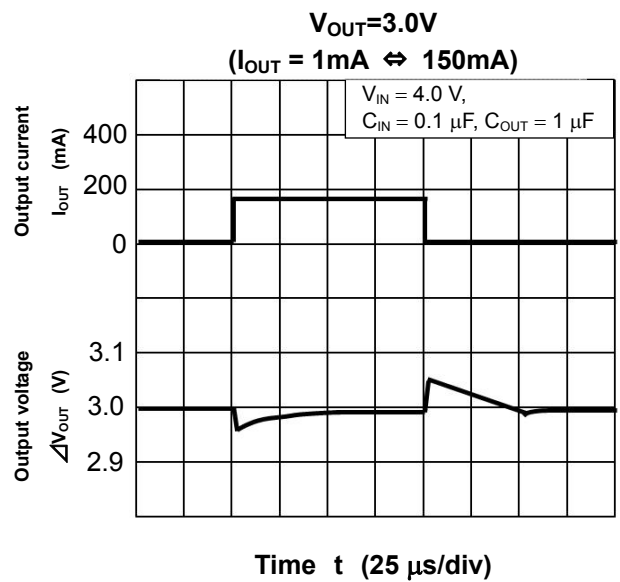
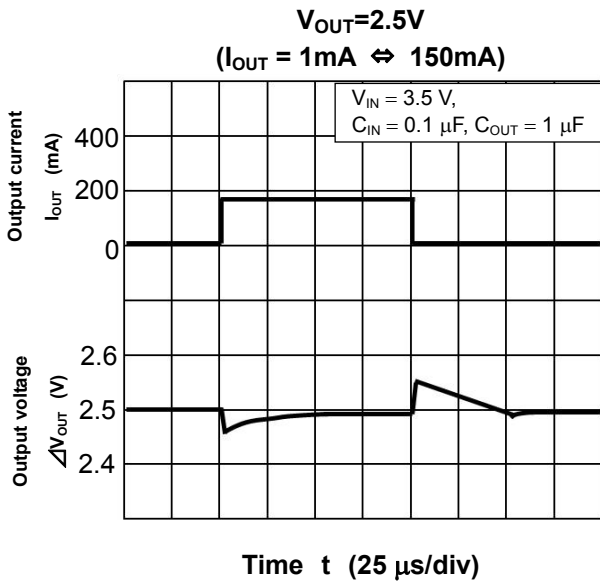
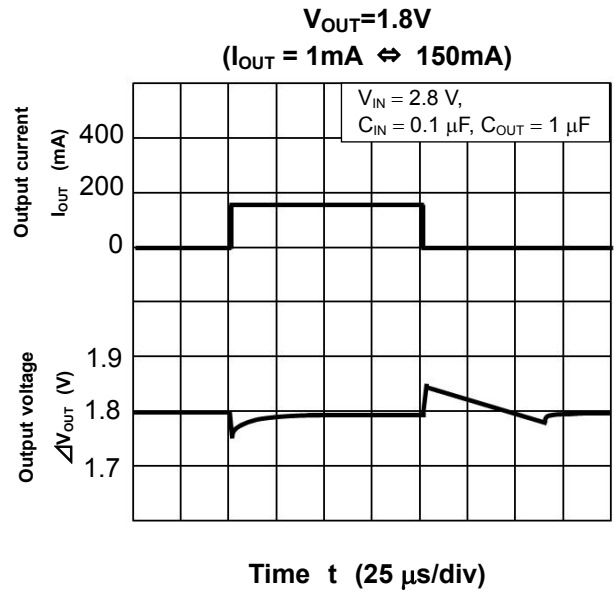
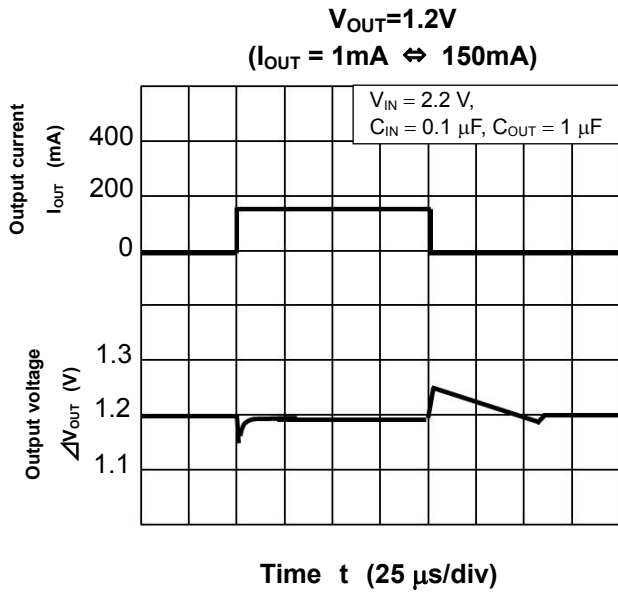



## RESTRICTIONS ON PRODUCT USE

- Toshiba Corporation, and its subsidiaries and affiliates (collectively "TOSHIBA"), reserve the right to make changes to the information in this document, and related hardware, software and systems (collectively "Product") without notice.
- This document and any information herein may not be reproduced without prior written permission from TOSHIBA. Even with TOSHIBA's written permission, reproduction is permissible only if reproduction is without alteration/omission.
- Though TOSHIBA works continually to improve Product's quality and reliability, Product can malfunction or fail. Customers are responsible for complying with safety standards and for providing adequate designs and safeguards for their hardware, software and systems which minimize risk and avoid situations in which a malfunction or failure of Product could cause loss of human life, bodily injury or damage to property, including data loss or corruption. Before customers use the Product, create designs including the Product, or incorporate the Product into their own applications, customers must also refer to and comply with (a) the latest versions of all relevant TOSHIBA information, including without limitation, this document, the specifications, the data sheets and application notes for Product and the precautions and conditions set forth in the "TOSHIBA Semiconductor Reliability Handbook" and (b) the instructions for the application with which the Product will be used with or for. Customers are solely responsible for all aspects of their own product design or applications, including but not limited to (a) determining the appropriateness of the use of this Product in such design or applications; (b) evaluating and determining the applicability of any information contained in this document, or in charts, diagrams, programs, algorithms, sample application circuits, or any other referenced documents; and (c) validating all operating parameters for such designs and applications. **TOSHIBA ASSUMES NO LIABILITY FOR CUSTOMERS' PRODUCT DESIGN OR APPLICATIONS.**
- **PRODUCT IS NEITHER INTENDED NOR WARRANTED FOR USE IN EQUIPMENTS OR SYSTEMS THAT REQUIRE EXTRAORDINARILY HIGH LEVELS OF QUALITY AND/OR RELIABILITY, AND/OR A MALFUNCTION OR FAILURE OF WHICH MAY CAUSE LOSS OF HUMAN LIFE, BODILY INJURY, SERIOUS PROPERTY DAMAGE AND/OR SERIOUS PUBLIC IMPACT ("UNINTENDED USE").** Except for specific applications as expressly stated in this document, Unintended Use includes, without limitation, equipment used in nuclear facilities, equipment used in the aerospace industry, medical equipment, equipment used for automobiles, trains, ships and other transportation, traffic signaling equipment, equipment used to control combustions or explosions, safety devices, elevators and escalators, devices related to electric power, and equipment used in finance-related fields. **IF YOU USE PRODUCT FOR UNINTENDED USE, TOSHIBA ASSUMES NO LIABILITY FOR PRODUCT.** For details, please contact your TOSHIBA sales representative.
- Do not disassemble, analyze, reverse-engineer, alter, modify, translate or copy Product, whether in whole or in part.
- Product shall not be used for or incorporated into any products or systems whose manufacture, use, or sale is prohibited under any applicable laws or regulations.
- The information contained herein is presented only as guidance for Product use. No responsibility is assumed by TOSHIBA for any infringement of patents or any other intellectual property rights of third parties that may result from the use of Product. No license to any intellectual property right is granted by this document, whether express or implied, by estoppel or otherwise.
- **ABSENT A WRITTEN SIGNED AGREEMENT, EXCEPT AS PROVIDED IN THE RELEVANT TERMS AND CONDITIONS OF SALE FOR PRODUCT, AND TO THE MAXIMUM EXTENT ALLOWABLE BY LAW, TOSHIBA (1) ASSUMES NO LIABILITY WHATSOEVER, INCLUDING WITHOUT LIMITATION, INDIRECT, CONSEQUENTIAL, SPECIAL, OR INCIDENTAL DAMAGES OR LOSS, INCLUDING WITHOUT LIMITATION, LOSS OF PROFITS, LOSS OF OPPORTUNITIES, BUSINESS INTERRUPTION AND LOSS OF DATA, AND (2) DISCLAIMS ANY AND ALL EXPRESS OR IMPLIED WARRANTIES AND CONDITIONS RELATED TO SALE, USE OF PRODUCT, OR INFORMATION, INCLUDING WARRANTIES OR CONDITIONS OF MERCHANTABILITY, FITNESS FOR A PARTICULAR PURPOSE, ACCURACY OF INFORMATION, OR NONINFRINGEMENT.**
- Do not use or otherwise make available Product or related software or technology for any military purposes, including without limitation, for the design, development, use, stockpiling or manufacturing of nuclear, chemical, or biological weapons or missile technology products (mass destruction weapons). Product and related software and technology may be controlled under the applicable export laws and regulations including, without limitation, the Japanese Foreign Exchange and Foreign Trade Law and the U.S. Export Administration Regulations. Export and re-export of Product or related software or technology are strictly prohibited except in compliance with all applicable export laws and regulations.
- Please contact your TOSHIBA sales representative for details as to environmental matters such as the RoHS compatibility of Product. Please use Product in compliance with all applicable laws and regulations that regulate the inclusion or use of controlled substances, including without limitation, the EU RoHS Directive. **TOSHIBA ASSUMES NO LIABILITY FOR DAMAGES OR LOSSES OCCURRING AS A RESULT OF NONCOMPLIANCE WITH APPLICABLE LAWS AND REGULATIONS.**

## X-ON Electronics

Largest Supplier of Electrical and Electronic Components

*Click to view similar products for [LDO Voltage Regulators](#) category:*

*Click to view products by [Toshiba](#) manufacturer:*

Other Similar products are found below :

[AP7363-SP-13](#) [L79M05TL-E](#) [PT7M8202B12TA5EX](#) [TCR3DF185,LM\(CT](#) [TCR3DF24,LM\(CT](#) [TCR3DF285,LM\(CT](#) [TCR3DF31,LM\(CT](#)  
[TCR3DF45,LM\(CT](#) [MP2013GQ-33-Z](#) [059985X](#) [NCP4687DH15T1G](#) [701326R](#) [TCR2EN28,LF\(S](#) [NCV8170AXV250T2G](#)  
[TCR3DF27,LM\(CT](#) [TCR3DF19,LM\(CT](#) [TCR3DF125,LM\(CT](#) [TCR2EN18,LF\(S](#) [AP2112R5A-3.3TRG1](#) [AP7315-25W5-7](#)  
[IFX30081LDVGRNXUMA1](#) [AP2113KTR-G1](#) [AP2111H-1.2TRG1](#) [ZLDO1117QK50TC](#) [AZ1117IH-1.8TRG1](#) [AZ1117ID-ADJTRG1](#)  
[TCR3DG12,LF](#) [MIC5514-3.3YMT-T5](#) [MIC5512-1.2YMT-T5](#) [MIC5317-2.8YM5-T5](#) [SCD7912BTG](#) [NCP154MX180270TAG](#) [SCD33269T-](#)  
[5.0G](#) [NCV8170BMX330TCG](#) [NCV8170AMX120TCG](#) [NCP706ABMX300TAG](#) [NCP153MX330180TCG](#) [NCP114BMX075TCG](#)  
[MC33269T-3.5G](#) [CAT6243-ADJCMT5T](#) [TCR3DG33,LF](#) [AP2127N-1.0TRG1](#) [TCR4DG35,LF](#) [LT1117CST-3.3](#) [LT1117CST-5](#)  
[TAR5S15U\(TE85L,F\)](#) [TAR5S18U\(TE85L,F\)](#) [TCR3UG19A,LF](#) [TCR4DG105,LF](#) [NCV8170AMX360TCG](#)