

TOSHIBA CMOS Linear Integrated Circuit Silicon Monolithic

TCR2LF series

TCR2LE series

Ultra low quiescent current 200 mA CMOS Low Drop-Out Regulator in ultra small package

The TCR2LF and TCR2LE series are CMOS general-purpose single-output voltage regulators with an on/off control input, featuring ultra low quiescent bias current and low dropout voltage.

These voltage regulators are available in fixed output voltages between 0.8 V and 3.6 V and capable of driving up to 200 mA. They feature overcurrent protection and Auto-discharge function.

The package is general SMV(SOT-25) (2.8 mm x 2.9 mm x 1.1 mm) and ESV(SOT-553) (1.6 mm x 1.6 mm x 0.55 mm), and has a low dropout voltage of 270 mV (2.5 V output, I_{OUT} = 150 mA).

As small ceramic input and output capacitors 0.1 μ F can be used with the TCR2LF and TCR2LE series, these devices are ideal for portable applications that require high-density board assembly such as cellular phones.

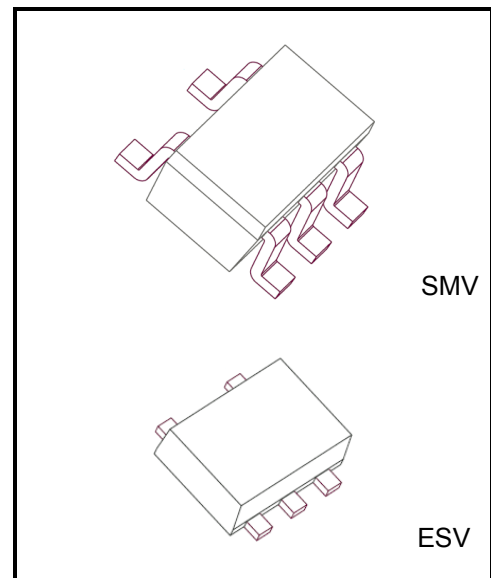

Weight :
SMV (SOT-25)(SC-74A) : 16.0 mg (typ.)
ESV (SOT-553) : 3.0 mg (typ.)

Features

- Low quiescent bias current ($I_B = 2 \mu\text{A}$ (max) at $I_{OUT} = 0 \text{ mA}$, $T_j = -40$ to 85°C)
- Low Drop-Out voltage
 $V_{IN}-V_{OUT} = 270 \text{ mV}$ (typ.) at 2.5 V-output, $I_{OUT} = 150 \text{ mA}$
- Wide range output voltage line up ($V_{OUT} = 0.8$ to 3.6 V)
- High V_{OUT} accuracy $\pm 1.0\%$ ($1.8\text{V} \leq V_{OUT}$)
- Overcurrent protection
- Auto-discharge
- Pull down connection between CONTROL and GND
- Ceramic capacitors can be used ($C_{IN} = 0.1 \mu\text{F}$, $C_{OUT} = 0.1 \mu\text{F}$)
- General package SMV(SOT-25) (2.8 mm x 2.9 mm x 1.1 mm) and ESV(SOT-553) (1.6 mm x 1.6 mm x 0.55 mm)

Absolute Maximum Ratings (Ta = 25°C)

Characteristics	Symbol	Rating	Unit	
Input voltage	V_{IN}	6.0	V	
Control voltage	V_{CT}	-0.3 to 6.0	V	
Output voltage	V_{OUT}	-0.3 to $V_{IN} + 0.3$	V	
Output current	I_{OUT}	200	mA	
Power dissipation	P_D	SMV	200 (Note1)	mW
			580 (Note 2)	
		ESV	150 (Note 1)	
			320 (Note 3)	
Operation temperature range	T_{opr}	-40 to 85	°C	
Junction temperature	T_j	150	°C	
Storage temperature range	T_{stg}	-55 to 150	°C	

Note: Using continuously under heavy loads (e.g. the application of high temperature/current/voltage and the significant change in temperature, etc.) may cause this product to decrease in the reliability significantly even if the operating conditions (i.e. operating temperature/current/voltage, etc.) are within the absolute maximum ratings and the operating ranges.

Please design the appropriate reliability upon reviewing the Toshiba Semiconductor Reliability Handbook ("Handling Precautions"/"Derating Concept and Methods") and individual reliability data (i.e. reliability test report and estimated failure rate, etc).

Note 1: Unit Rating

Note 2: Rating at mounting on a board
(FR4 board: 25.4 mm × 25.4 mm × 1.6 mm)

Note 3: Rating at mounting on a board
(FR4 board dimension: 30 mm × 30 mm × 0.8 mm)

Pin Assignment (top view)

SMV(SOT-25)(SC-74A)

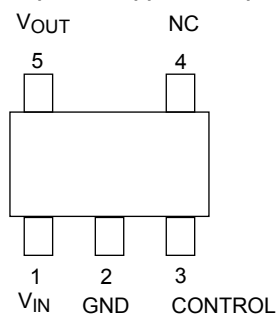

ESV(SOT-553)

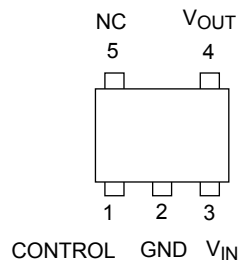

List of Products Number, Output voltage and Marking

TCR2LF and TCR2LE series

Product No.		V _{OUT} (V) (typ.)	Marking	Product No.		V _{OUT} (V) (typ.)	Marking
SMV(SOT-25)	ESV(SOT-553)			SMV(SOT-25)	ESV(SOT-553)		
TCR2LF08	TCR2LE08	0.8	0L8	TCR2LF19	TCR2LE19	1.9	1L9
TCR2LF085	TCR2LE085	0.85	0LD	TCR2LF20	TCR2LE20	2.0	2L0
TCR2LF09	TCR2LE09	0.9	0L9	TCR2LF21	TCR2LE21	2.1	2L1
TCR2LF095	TCR2LE095	0.95	0LE	TCR2LF25	TCR2LE25	2.5	2L5
TCR2LF10	TCR2LE10	1.0	1L0	TCR2LF27	TCR2LE27	2.7	2L7
TCR2LF105	TCR2LE105	1.05	1LA	TCR2LF28	TCR2LE28	2.8	2L8
TCR2LF11	TCR2LE11	1.1	1L1	TCR2LF285	TCR2LE285	2.85	2LD
TCR2LF115	TCR2LE115	1.15	1LB	TCR2LF30	TCR2LE30	3.0	3L0
TCR2LF12	TCR2LE12	1.2	1L2	TCR2LF31	TCR2LE31	3.1	3L1
TCR2LF13	TCR2LE13	1.3	1L3	TCR2LF32	TCR2LE32	3.2	3L2
TCR2LF15	TCR2LE15	1.5	1L5	TCR2LF33	TCR2LE33	3.3	3L3
TCR2LF18	TCR2LE18	1.8	1L8	TCR2LF36	TCR2LE36	3.6	3L6

* Please contact local Toshiba representative if you are interested in product that output voltage is not in the list.

Marking (top view)

Example: TCR2LF33 (3.3 V output)

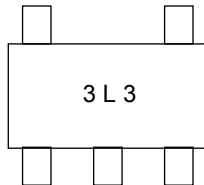

Example: TCR2LE33 (3.3 V output)

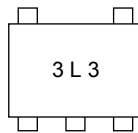

Electrical Characteristics

(Unless otherwise specified,

$V_{IN} = V_{OUT} + 1\text{ V}$ ($V_{OUT} > 1.5\text{ V}$), $V_{IN} = 2.5\text{ V}$ ($V_{OUT} \leq 1.5\text{ V}$), $I_{OUT} = 50\text{ mA}$, $C_{IN} = 0.1\text{ }\mu\text{F}$, $C_{OUT} = 0.1\text{ }\mu\text{F}$)

Characteristics	Symbol	Test Condition	$T_j = 25^\circ\text{C}$			$T_j = -40\text{ to }85^\circ\text{C}$		Unit	
			Min	Typ.	Max	Min	Max		
Output voltage accuracy	V_{OUT}	$I_{OUT} = 50\text{ mA}$ (Note 4)	$V_{OUT} < 1.8\text{ V}$	-18	—	+18	—	—	mV
			$1.8\text{ V} \leq V_{OUT}$	-1.0	—	+1.0	—	—	%
Input voltage	V_{IN}	$I_{OUT} = 1\text{ mA}$	1.5	—	5.5	1.5	5.5	V	
Line regulation	Reg·line	$V_{OUT} + 0.5\text{ V} \leq V_{IN} \leq 5.5\text{ V}$, $I_{OUT} = 1\text{ mA}$	—	1	15	—	—	mV	
Load regulation	Reg·load	$1\text{ mA} \leq I_{OUT} \leq 150\text{ mA}$	—	15	30	—	—	mV	
Quiescent current	I_B	$I_{OUT} = 0\text{ mA}$ (Note 5)	—	1.0	—	—	2.0	μA	
Stand-by current	$I_B(\text{OFF})$	$V_{CT} = 0\text{ V}$	—	0.1	—	—	1.0	μA	
Control pull down current	I_{CT}	—	—	0.1	—	—	—	μA	
Drop-out voltage	$V_{IN}-V_{OUT}$	$I_{OUT} = 150\text{ mA}$	$V_{OUT} = 1.8\text{ V}$	—	370	—	—	620	mV
			$V_{OUT} = 3.0\text{ V}$	—	220	—	—	300	mV
Temperature coefficient	T_{CVO}	$-40^\circ\text{C} \leq T_{opr} \leq 85^\circ\text{C}$	—	75	—	—	—	ppm/ $^\circ\text{C}$	
Control voltage (ON)	$V_{CT}(\text{ON})$	—	1.0	—	5.5	1.0	5.5	V	
Control voltage (OFF)	$V_{CT}(\text{OFF})$	—	0	—	0.4	0	0.4	V	
Discharge on resistance	R_{SD}	—	—	20	—	—	—	Ω	

Note 4: Stable state with fixed I_{OUT} condition

Note 5: Except Control pull down current

Drop-out voltage

($I_{OUT} = 150\text{ mA}$, $C_{IN} = 0.1\text{ }\mu\text{F}$, $C_{OUT} = 0.1\text{ }\mu\text{F}$, $T_j = 25^\circ\text{C}$)

Output voltages	Symbol	Min	Typ.	Max(Note 6)	Unit
$0.8\text{ V} \leq V_{OUT} < 0.9\text{ V}$	$V_{IN}-V_{OUT}$	—	1020	1580	mV
$0.9\text{ V} \leq V_{OUT} < 1.0\text{ V}$		—	940	1480	
$1.0\text{ V} \leq V_{OUT} < 1.1\text{ V}$		—	860	1400	
$1.1\text{ V} \leq V_{OUT} < 1.2\text{ V}$		—	780	1300	
$1.2\text{ V} \leq V_{OUT} < 1.3\text{ V}$		—	700	1250	
$1.3\text{ V} \leq V_{OUT} < 1.6\text{ V}$		—	620	1130	
$1.6\text{ V} \leq V_{OUT} < 1.8\text{ V}$		—	470	860	
$1.8\text{ V} \leq V_{OUT} < 2.0\text{ V}$		—	370	620	
$2.0\text{ V} \leq V_{OUT} < 2.5\text{ V}$		—	320	560	
$2.5\text{ V} \leq V_{OUT} < 3.0\text{ V}$		—	270	380	
$3.0\text{ V} \leq V_{OUT} \leq 3.6\text{ V}$		—	220	300	

Note 6: $T_j = -40\text{ to }85^\circ\text{C}$

Application Note

1. Recommended Application Circuit

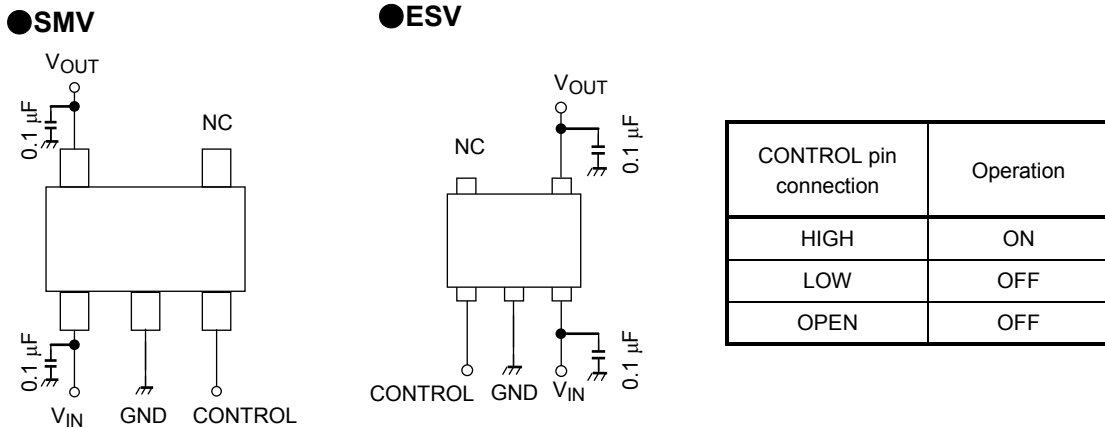

The figure above shows the recommended configuration for using a Low-Dropout regulator. Insert a capacitor at V_{OUT} and V_{IN} pins for stable input/output operation. (Ceramic capacitors can be used).

2. Power Dissipation

Both unit and board-mounted power dissipation ratings for TCR2LF series and TCR2LE series are available in the Absolute Maximum Ratings table.

Power dissipation is measured on the board shown below.

Testing Board of Thermal Resistance

SMV

*Board material: FR4 board
 Board dimension: 25.4 mm × 25.4 mm × 1.6 mm
 Copper area: 645 mm²

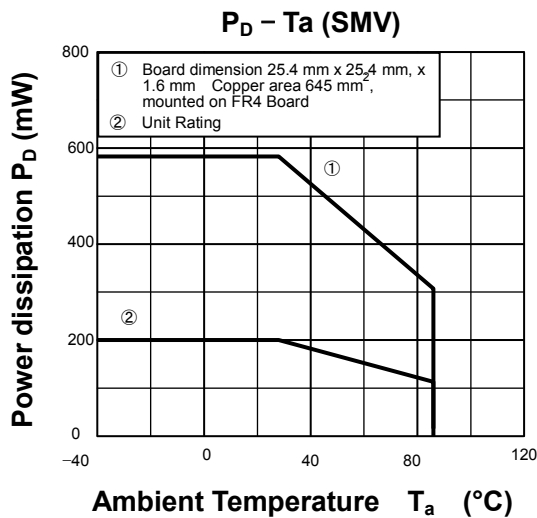

ESV

*Board material: FR4
 Board dimension: 30 mm × 30 mm × 0.8 mm
 Copper area: 20 mm²

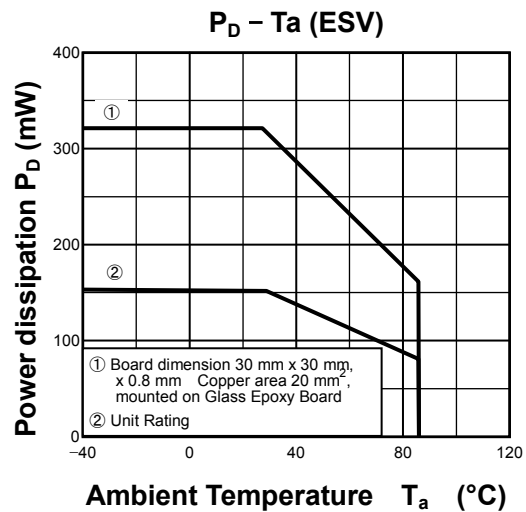

Attention in Use

- **Output Capacitors**
Ceramic capacitors can be used for these devices. However, because of the type of the capacitors, there might be unexpected thermal features. Please consider application condition for selecting capacitors. And Toshiba recommend the ESR of ceramic capacitor is under 10 Ω .

- **Mounting**
The long distance between IC and output capacitor might affect phase assurance by impedance in wire and inductor. For stable power supply, output capacitor need to mount near IC as much as possible. Also VIN and GND pattern need to be large and make the wire impedance small as possible.

- **Permissible Loss**
Please have enough design patterns for expected maximum permissible loss. And under consideration of surrounding temperature, input voltage, and output current etc, we recommend proper dissipation ratings for maximum permissible loss; in general maximum dissipation rating is 70 to 80 percent.

- **Overcurrent Protection Circuit**
Overcurrent protection circuit is designed in these products, but this does not assure for the suppression of uprising device operation. If output pins and GND pins are shorted out, these products might be break down. In use of these products, please read through and understand dissipation idea for absolute maximum ratings from the above mention or our 'Semiconductor Reliability Handbook'. Then use these products under absolute maximum ratings in any condition. Furthermore, Toshiba recommend inserting failsafe system into the design.

Representative Typical Characteristics

1) Output Voltage vs. Input Voltage

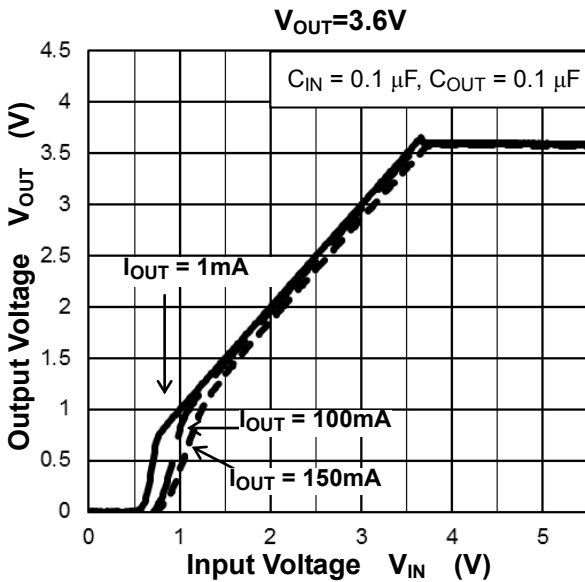
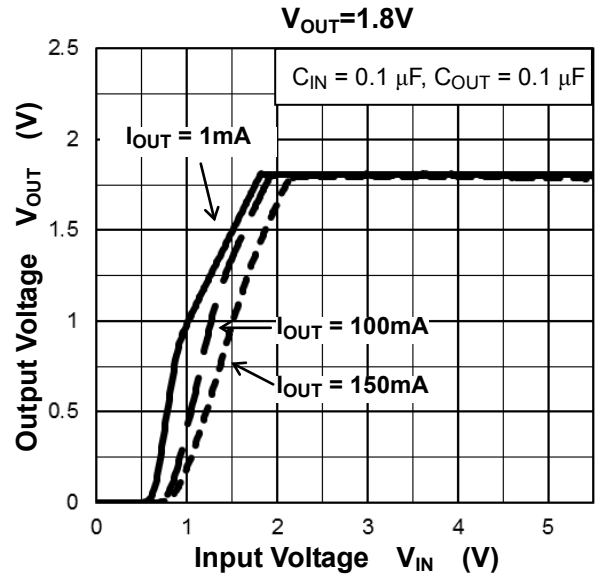
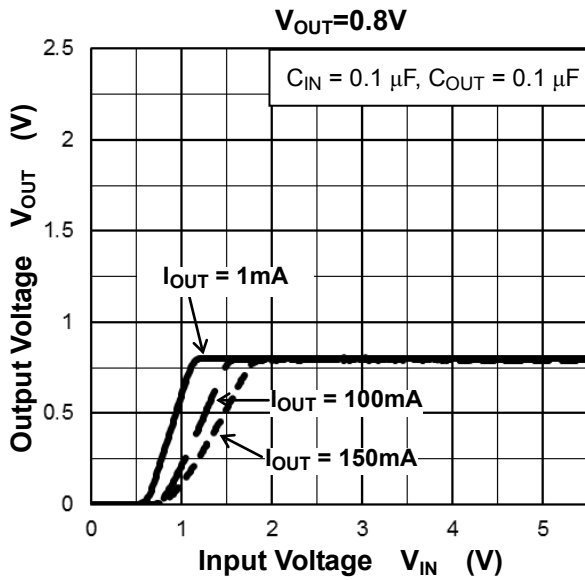

2) Quiescent Current vs. Input Voltage

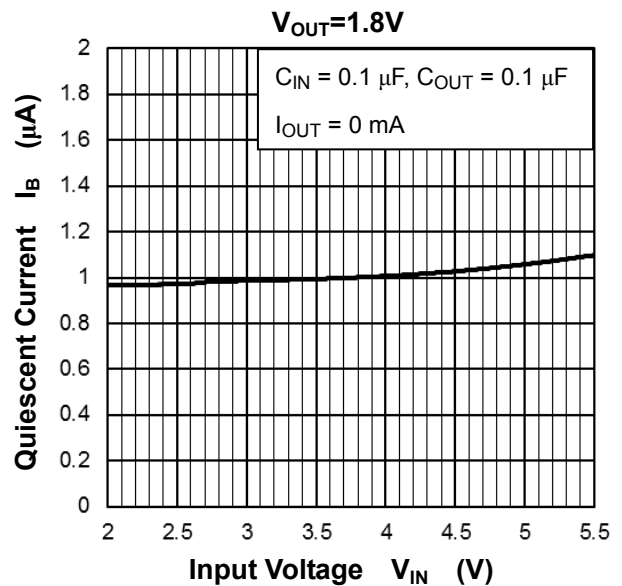
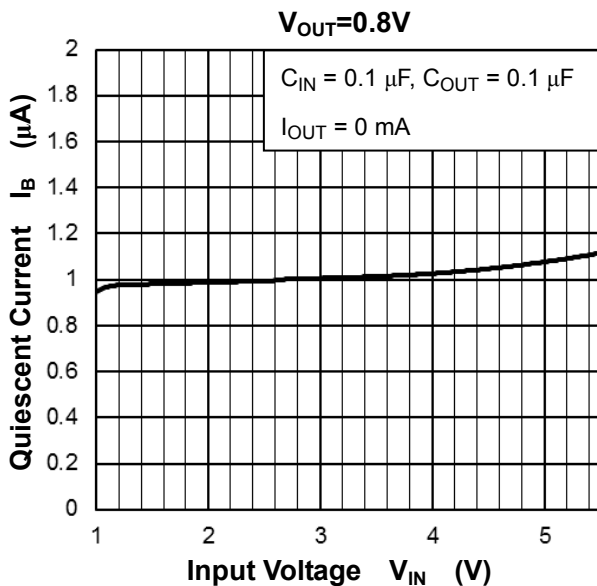

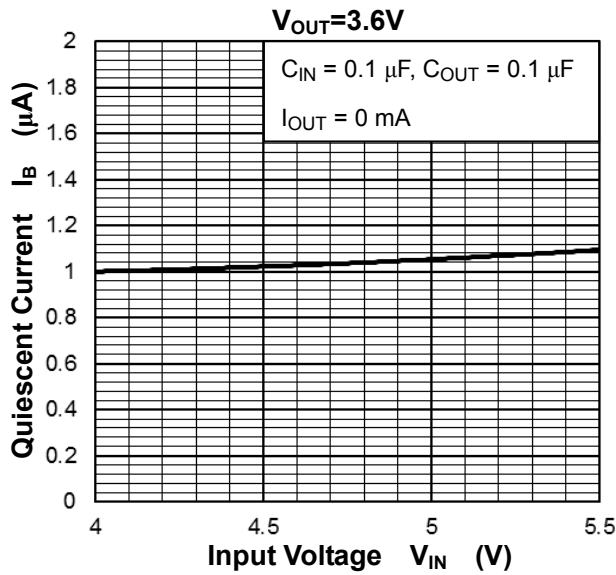

3) Output Voltage vs. Output Current

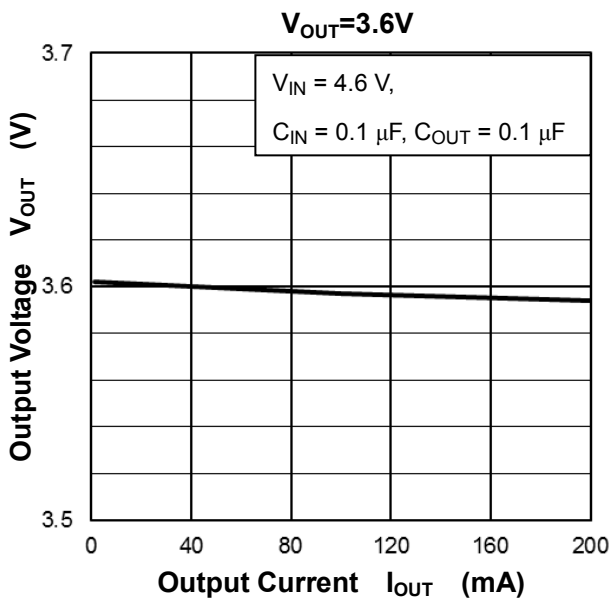
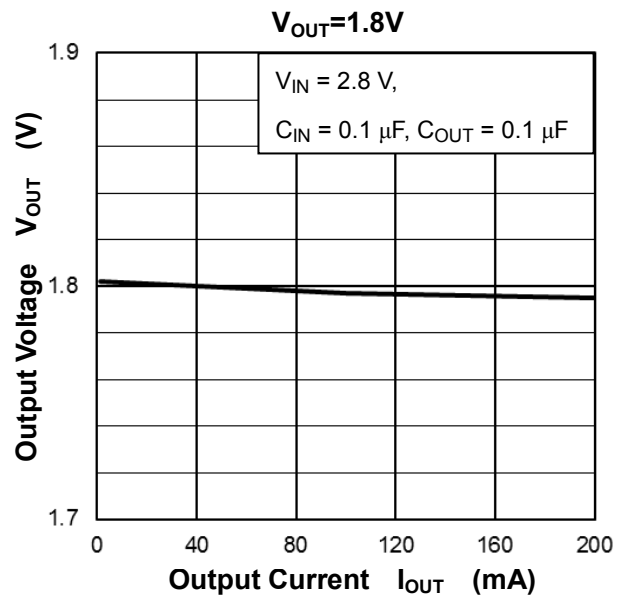
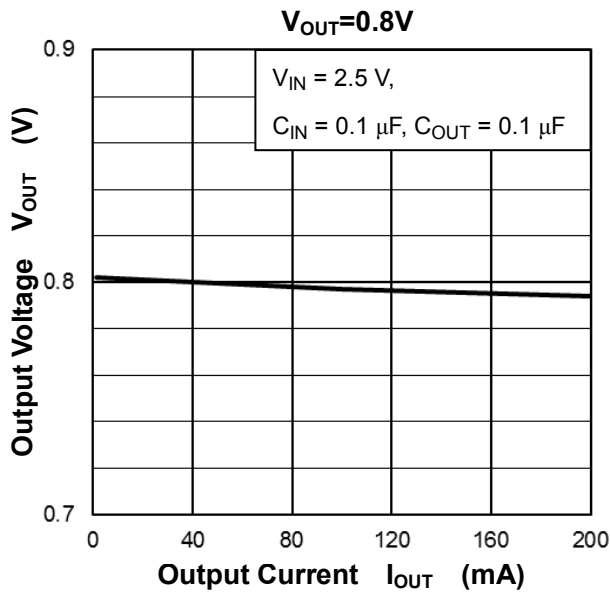

4) Output Voltage vs. Ambient Temperature

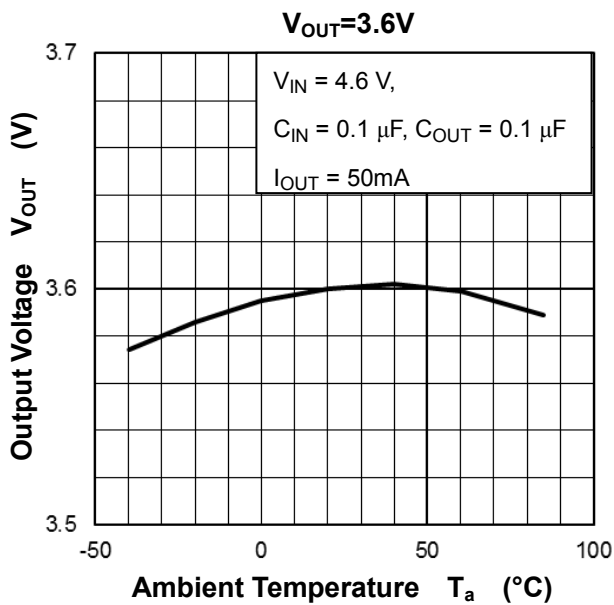
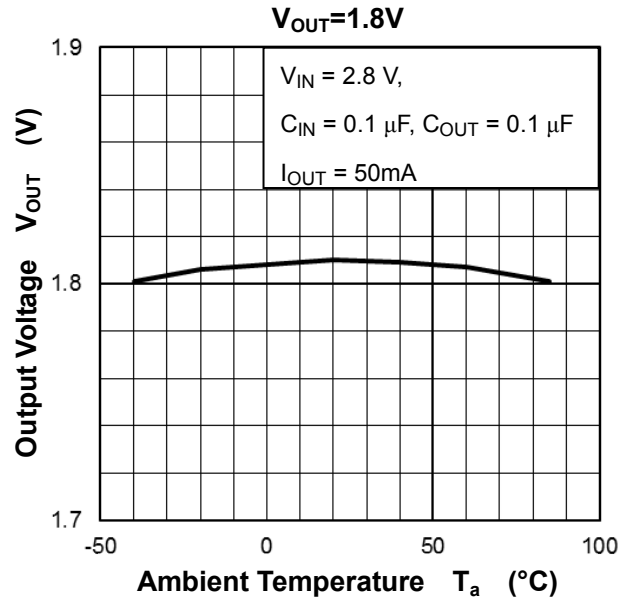
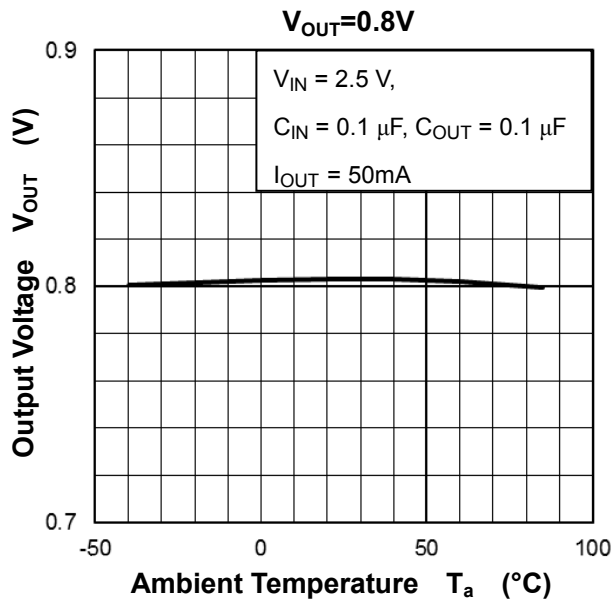

5) Dropout Voltage vs. Output Current

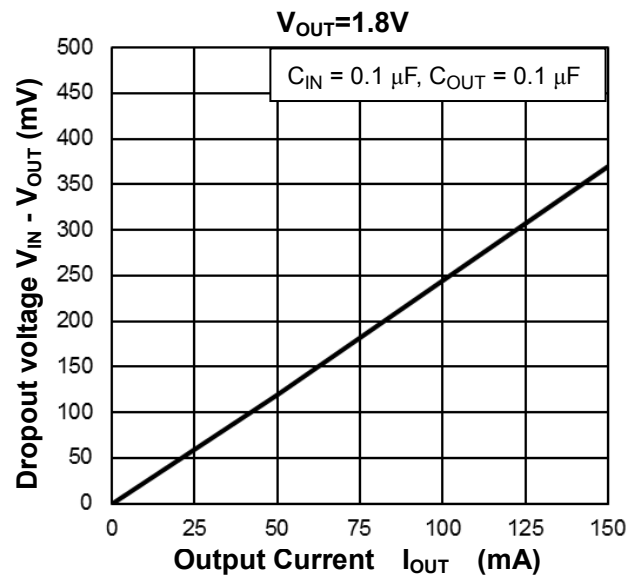
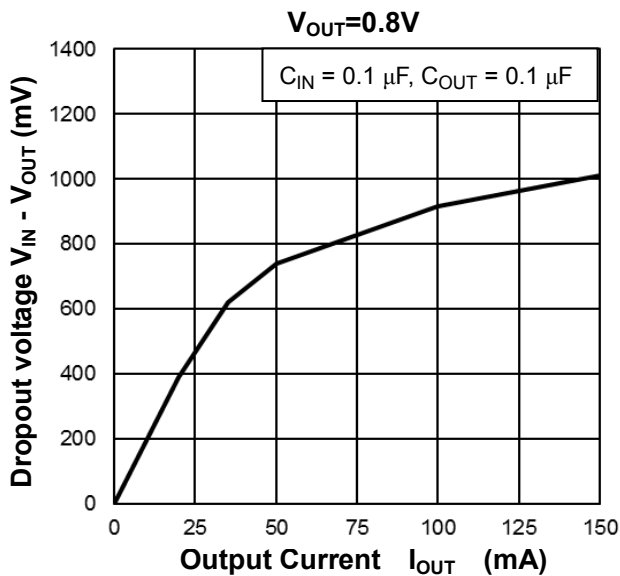

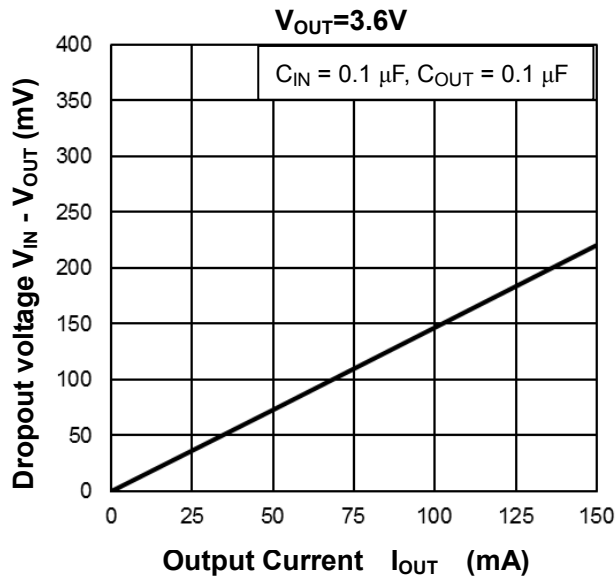

6) Quiescent Current vs. Ambient Temperature

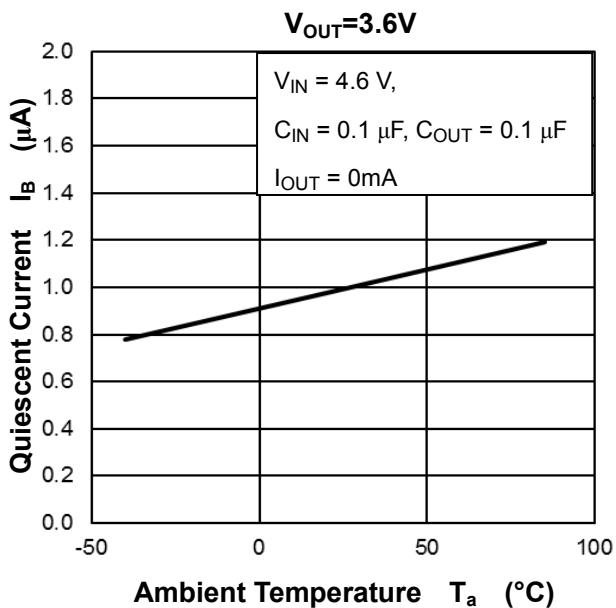
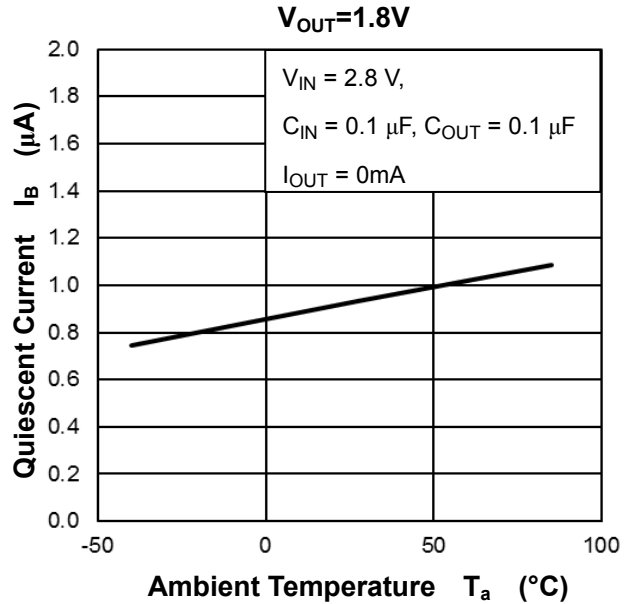
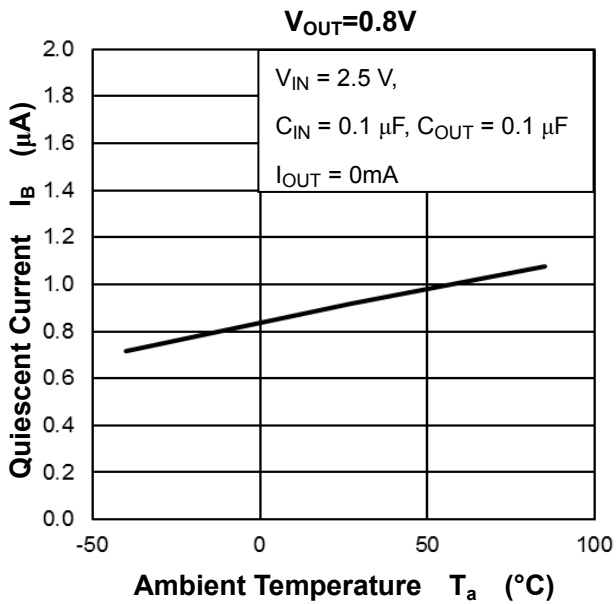

7) Ripple Rejection Ratio vs. Frequency

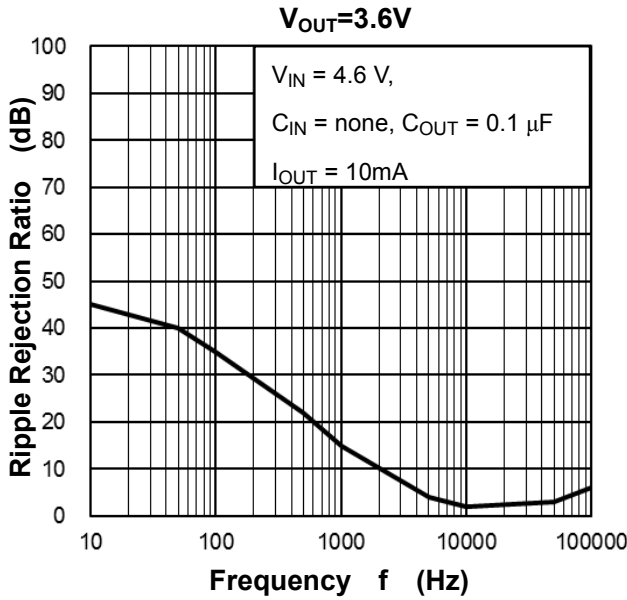
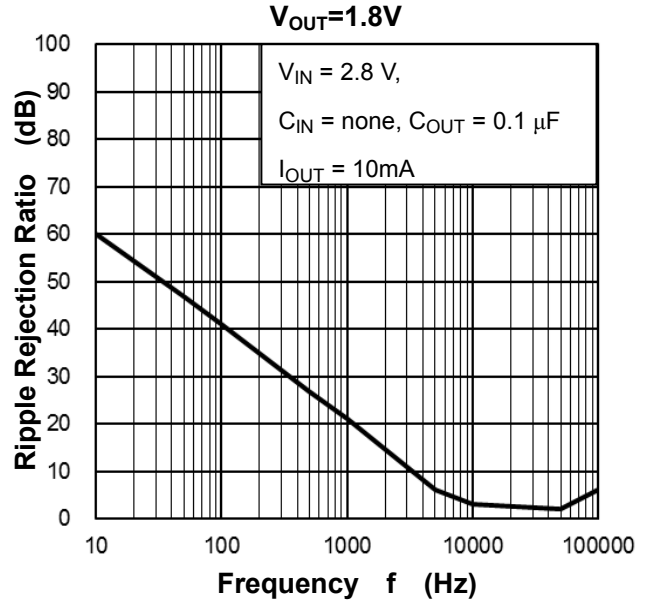
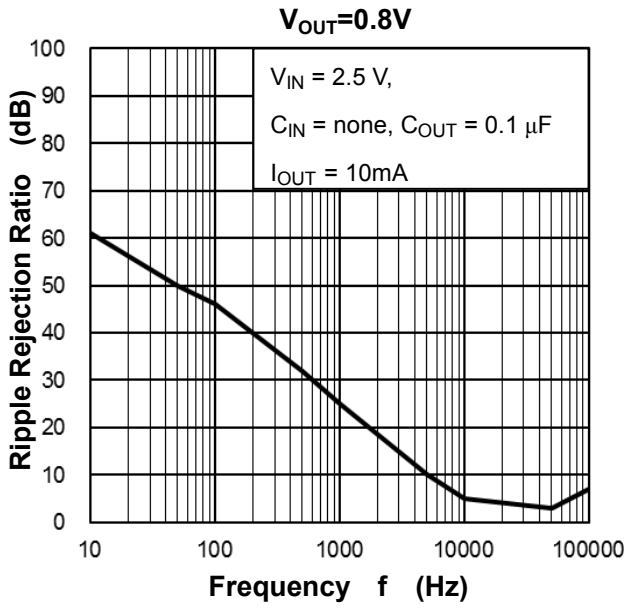

8) Output Voltage vs. Output Current

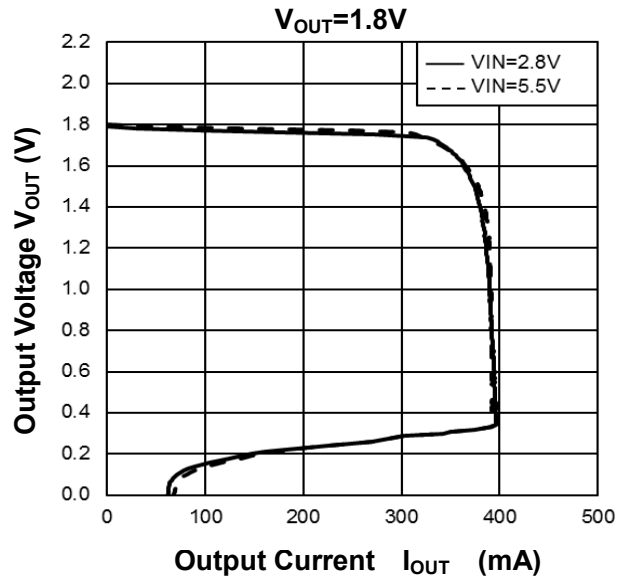
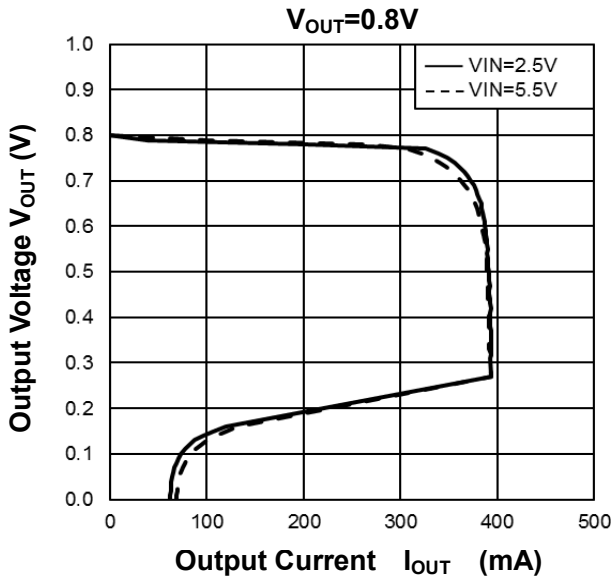

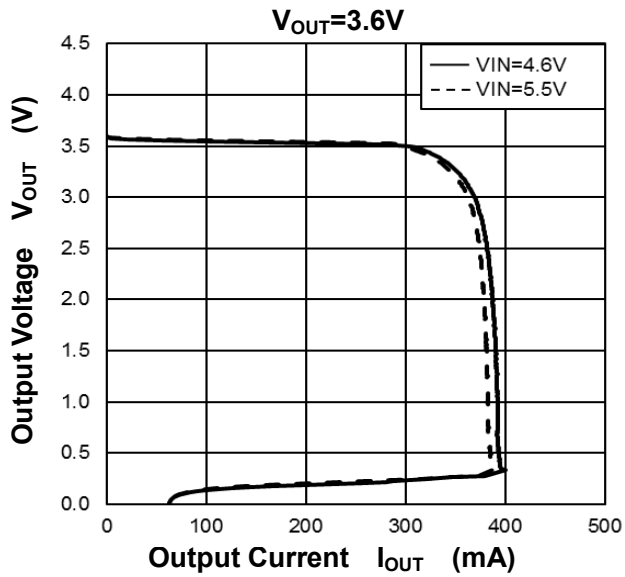

9) Control Transient vs. Response

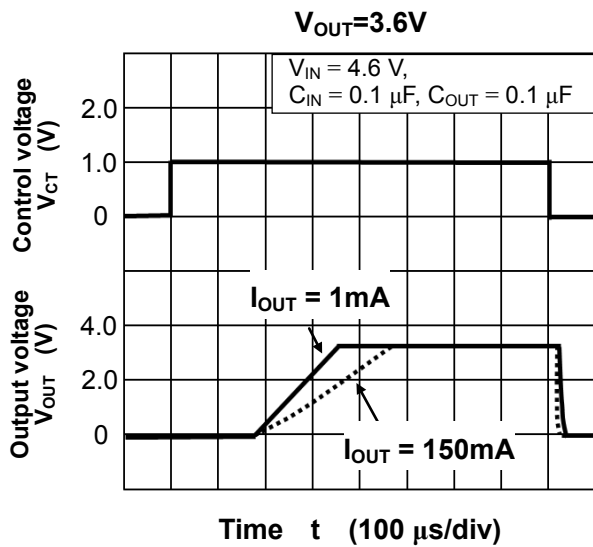
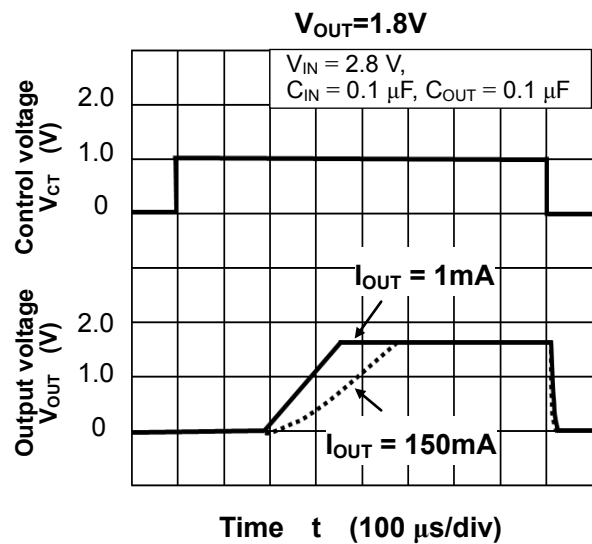
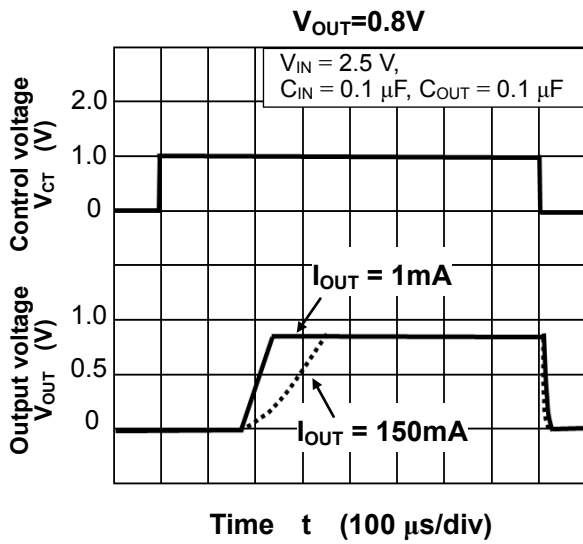

10) Load Transient Response

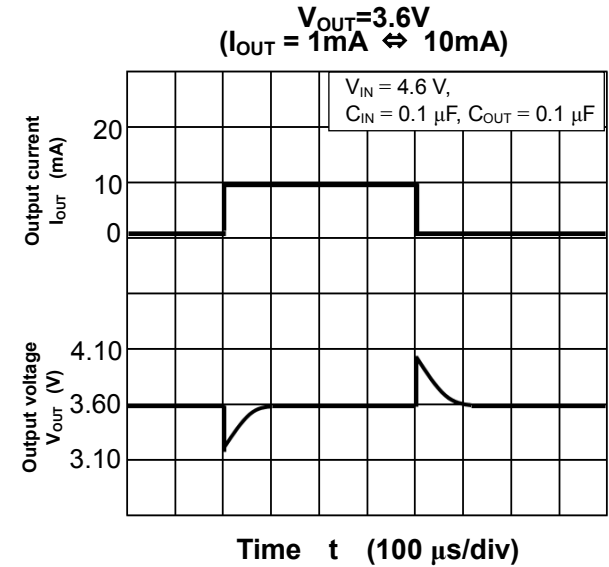
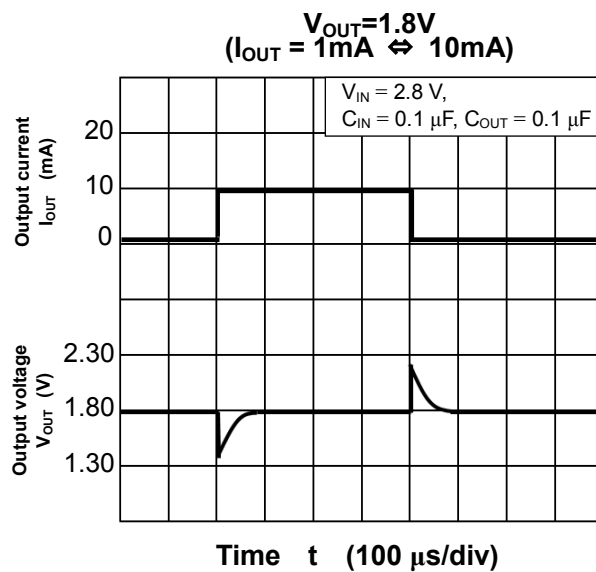
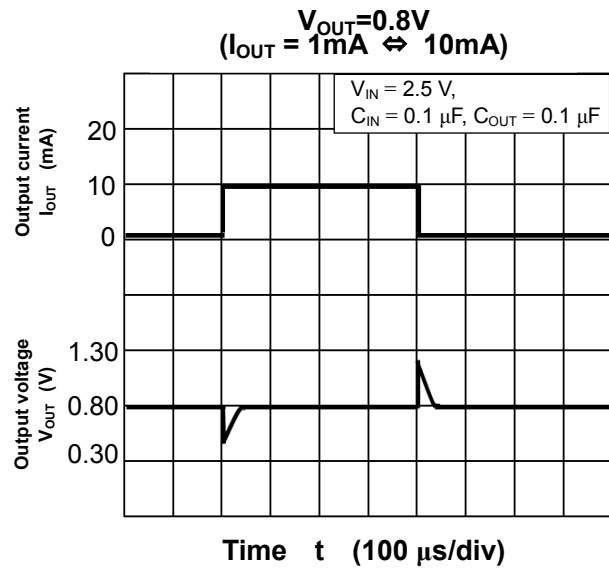
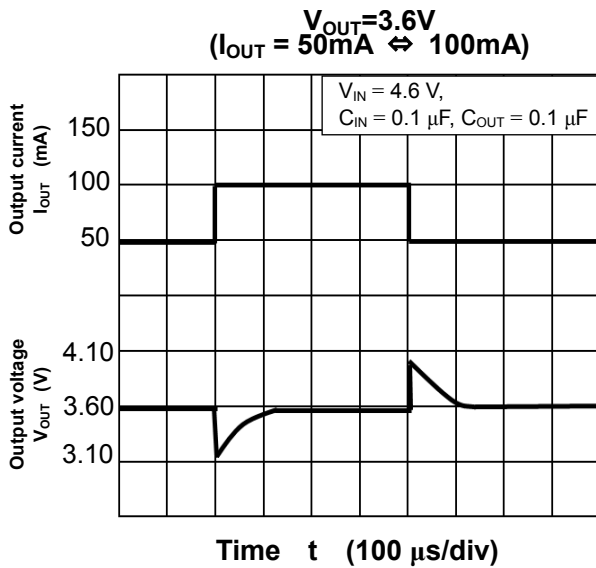
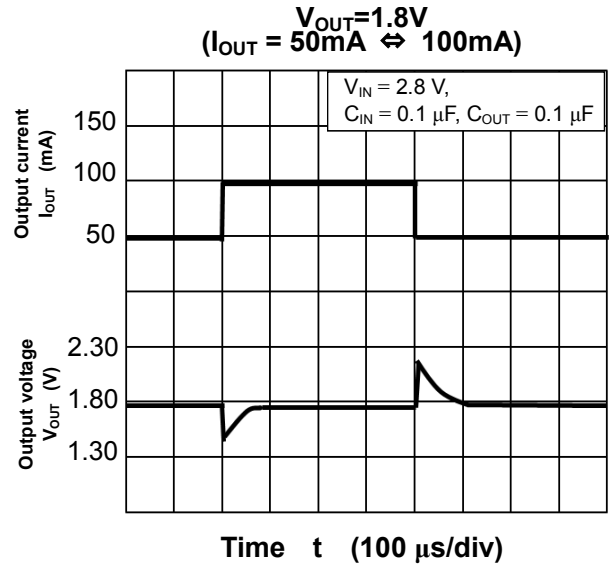
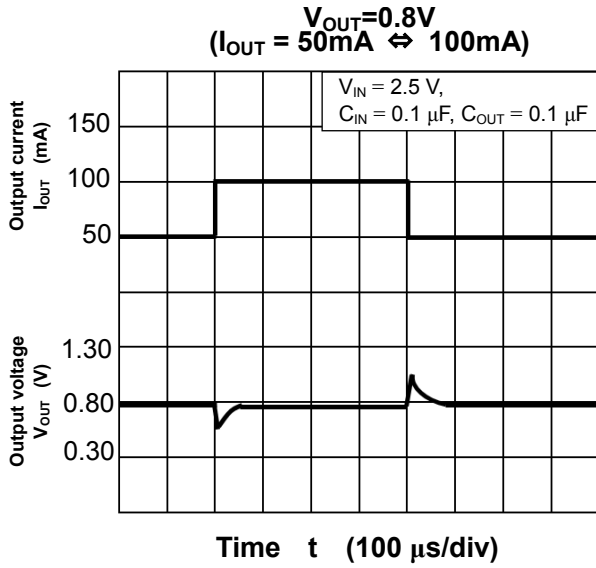

Package Dimensions

SMV (SOT-25)(SC-74A)

Unit: mm

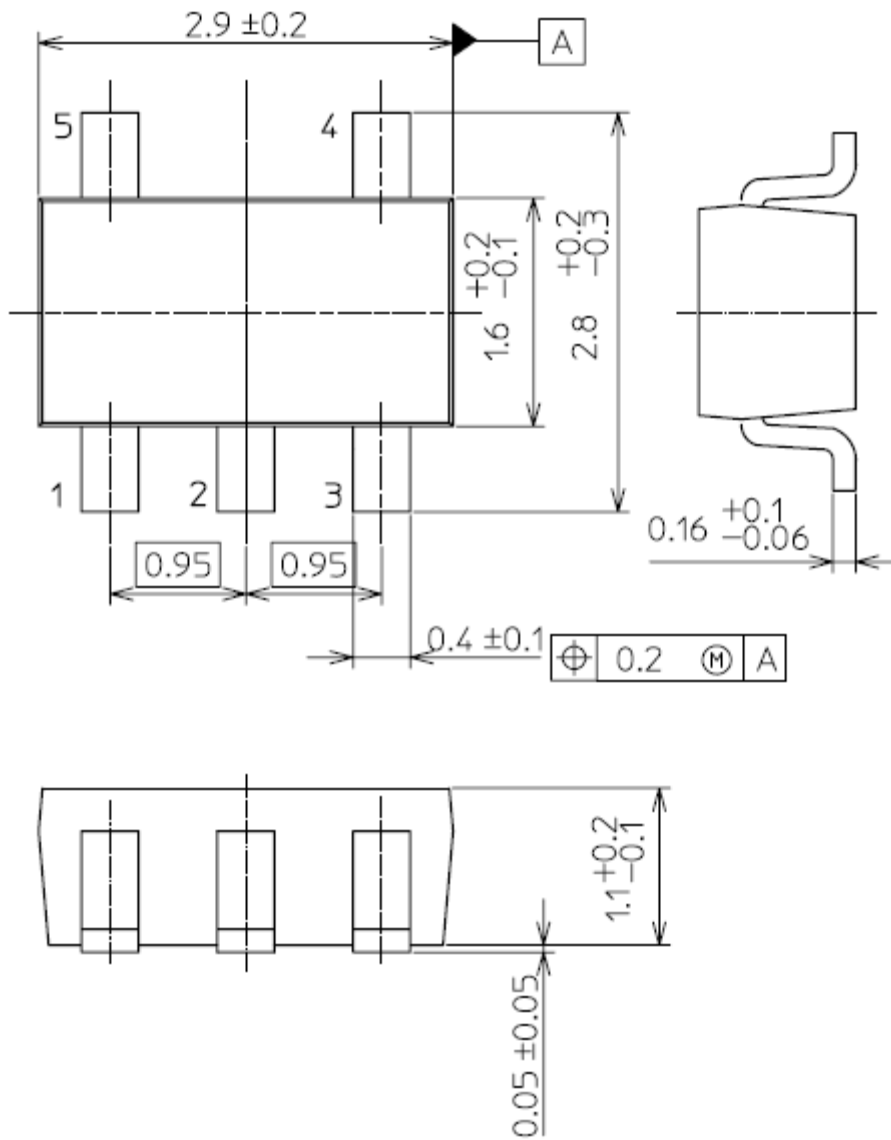

Weight : 16.0 mg (typ.)

Package Dimensions

ESV (SOT-553)

Unit: mm

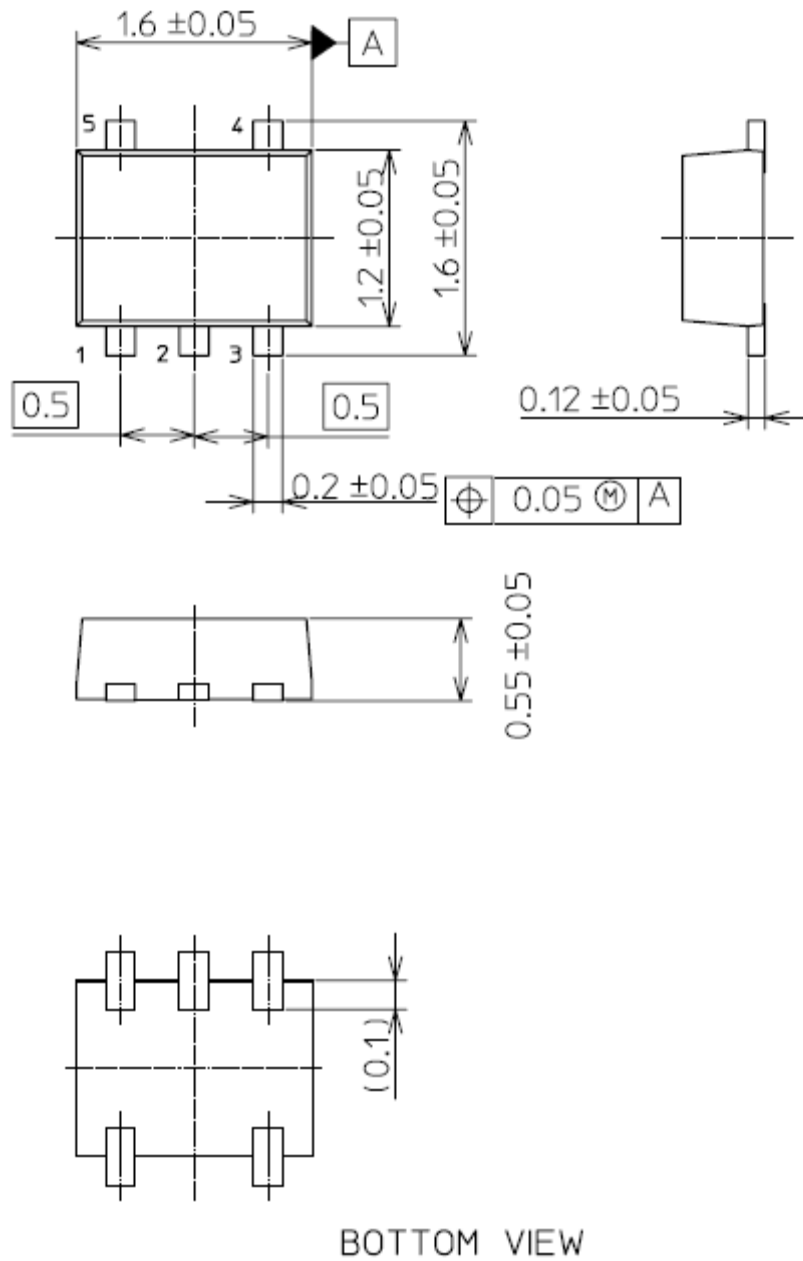

Weight: 3.0 mg (typ.)

RESTRICTIONS ON PRODUCT USE

- Toshiba Corporation, and its subsidiaries and affiliates (collectively "TOSHIBA"), reserve the right to make changes to the information in this document, and related hardware, software and systems (collectively "Product") without notice.
- This document and any information herein may not be reproduced without prior written permission from TOSHIBA. Even with TOSHIBA's written permission, reproduction is permissible only if reproduction is without alteration/omission.
- Though TOSHIBA works continually to improve Product's quality and reliability, Product can malfunction or fail. Customers are responsible for complying with safety standards and for providing adequate designs and safeguards for their hardware, software and systems which minimize risk and avoid situations in which a malfunction or failure of Product could cause loss of human life, bodily injury or damage to property, including data loss or corruption. Before customers use the Product, create designs including the Product, or incorporate the Product into their own applications, customers must also refer to and comply with (a) the latest versions of all relevant TOSHIBA information, including without limitation, this document, the specifications, the data sheets and application notes for Product and the precautions and conditions set forth in the "TOSHIBA Semiconductor Reliability Handbook" and (b) the instructions for the application with which the Product will be used with or for. Customers are solely responsible for all aspects of their own product design or applications, including but not limited to (a) determining the appropriateness of the use of this Product in such design or applications; (b) evaluating and determining the applicability of any information contained in this document, or in charts, diagrams, programs, algorithms, sample application circuits, or any other referenced documents; and (c) validating all operating parameters for such designs and applications. **TOSHIBA ASSUMES NO LIABILITY FOR CUSTOMERS' PRODUCT DESIGN OR APPLICATIONS.**
- **PRODUCT IS NEITHER INTENDED NOR WARRANTED FOR USE IN EQUIPMENTS OR SYSTEMS THAT REQUIRE EXTRAORDINARILY HIGH LEVELS OF QUALITY AND/OR RELIABILITY, AND/OR A MALFUNCTION OR FAILURE OF WHICH MAY CAUSE LOSS OF HUMAN LIFE, BODILY INJURY, SERIOUS PROPERTY DAMAGE AND/OR SERIOUS PUBLIC IMPACT ("UNINTENDED USE").** Except for specific applications as expressly stated in this document, Unintended Use includes, without limitation, equipment used in nuclear facilities, equipment used in the aerospace industry, medical equipment, equipment used for automobiles, trains, ships and other transportation, traffic signaling equipment, equipment used to control combustions or explosions, safety devices, elevators and escalators, devices related to electric power, and equipment used in finance-related fields. **IF YOU USE PRODUCT FOR UNINTENDED USE, TOSHIBA ASSUMES NO LIABILITY FOR PRODUCT.** For details, please contact your TOSHIBA sales representative.
- Do not disassemble, analyze, reverse-engineer, alter, modify, translate or copy Product, whether in whole or in part.
- Product shall not be used for or incorporated into any products or systems whose manufacture, use, or sale is prohibited under any applicable laws or regulations.
- The information contained herein is presented only as guidance for Product use. No responsibility is assumed by TOSHIBA for any infringement of patents or any other intellectual property rights of third parties that may result from the use of Product. No license to any intellectual property right is granted by this document, whether express or implied, by estoppel or otherwise.
- **ABSENT A WRITTEN SIGNED AGREEMENT, EXCEPT AS PROVIDED IN THE RELEVANT TERMS AND CONDITIONS OF SALE FOR PRODUCT, AND TO THE MAXIMUM EXTENT ALLOWABLE BY LAW, TOSHIBA (1) ASSUMES NO LIABILITY WHATSOEVER, INCLUDING WITHOUT LIMITATION, INDIRECT, CONSEQUENTIAL, SPECIAL, OR INCIDENTAL DAMAGES OR LOSS, INCLUDING WITHOUT LIMITATION, LOSS OF PROFITS, LOSS OF OPPORTUNITIES, BUSINESS INTERRUPTION AND LOSS OF DATA, AND (2) DISCLAIMS ANY AND ALL EXPRESS OR IMPLIED WARRANTIES AND CONDITIONS RELATED TO SALE, USE OF PRODUCT, OR INFORMATION, INCLUDING WARRANTIES OR CONDITIONS OF MERCHANTABILITY, FITNESS FOR A PARTICULAR PURPOSE, ACCURACY OF INFORMATION, OR NONINFRINGEMENT.**
- Do not use or otherwise make available Product or related software or technology for any military purposes, including without limitation, for the design, development, use, stockpiling or manufacturing of nuclear, chemical, or biological weapons or missile technology products (mass destruction weapons). Product and related software and technology may be controlled under the applicable export laws and regulations including, without limitation, the Japanese Foreign Exchange and Foreign Trade Law and the U.S. Export Administration Regulations. Export and re-export of Product or related software or technology are strictly prohibited except in compliance with all applicable export laws and regulations.
- Please contact your TOSHIBA sales representative for details as to environmental matters such as the RoHS compatibility of Product. Please use Product in compliance with all applicable laws and regulations that regulate the inclusion or use of controlled substances, including without limitation, the EU RoHS Directive. **TOSHIBA ASSUMES NO LIABILITY FOR DAMAGES OR LOSSES OCCURRING AS A RESULT OF NONCOMPLIANCE WITH APPLICABLE LAWS AND REGULATIONS.**

X-ON Electronics

Largest Supplier of Electrical and Electronic Components

Click to view similar products for [LDO Voltage Regulators](#) category:

Click to view products by [Toshiba](#) manufacturer:

Other Similar products are found below :

[AP7363-SP-13](#) [L79M05TL-E](#) [PT7M8202B12TA5EX](#) [TCR3DF185,LM\(CT](#) [TCR3DF24,LM\(CT](#) [TCR3DF285,LM\(CT](#) [TCR3DF31,LM\(CT](#)
[TCR3DF45,LM\(CT](#) [MP2013GQ-33-Z](#) [059985X](#) [NCP4687DH15T1G](#) [701326R](#) [TCR2EN28,LF\(S](#) [NCV8170AXV250T2G](#)
[TCR3DF27,LM\(CT](#) [TCR3DF19,LM\(CT](#) [TCR3DF125,LM\(CT](#) [TCR2EN18,LF\(S](#) [AP2112R5A-3.3TRG1](#) [AP7315-25W5-7](#)
[IFX30081LDVGRNXUMA1](#) [NCV47411PAAJR2G](#) [AP2113KTR-G1](#) [AP2111H-1.2TRG1](#) [ZLDO1117QK50TC](#) [AZ1117IH-1.8TRG1](#)
[AZ1117ID-ADJTRG1](#) [TCR3DG12,LF](#) [MIC5514-3.3YMT-T5](#) [MIC5512-1.2YMT-T5](#) [MIC5317-2.8YM5-T5](#) [SCD7912BTG](#)
[NCP154MX180270TAG](#) [SCD33269T-5.0G](#) [NCV8170BMX330TCG](#) [NCV8170AMX120TCG](#) [NCP706ABMX300TAG](#)
[NCP153MX330180TCG](#) [NCP114BMX075TCG](#) [MC33269T-3.5G](#) [CAT6243-ADJCMT5T](#) [TCR3DG33,LF](#) [AP2127N-1.0TRG1](#)
[TCR4DG35,LF](#) [LT1117CST-3.3](#) [LT1117CST-5](#) [TAR5S15U\(TE85L,F\)](#) [TAR5S18U\(TE85L,F\)](#) [TCR3UG19A,LF](#) [TCR4DG105,LF](#)