

TOSHIBA CMOS Linear Integrated Circuit Silicon Monolithic

TCR3UM series

Ultra low quiescent current, Fast Load Transient 300 mA CMOS Low Drop-Out Regulator in ultra small package

The TCR3UM series are CMOS general-purpose single-output voltage regulators with an on/off control input, featuring ultra low quiescent bias current and low dropout voltage.

These voltage regulators are available in fixed output voltages between 0.8 V and 5.0 V and capable of driving up to 300 mA. They feature Over-current protection, Thermal Shutdown function and Auto-discharge.

The TCR3UM series is offered in the ultra small plastic mold package DFN4 (1.0 mm x 1.0 mm; t 0.60 mm (max)) and has a low dropout voltage of 196 mV (3.3 V output, I_{OUT} = 300 mA). As small ceramic input and output capacitors 1 μ F can be used with the TCR3UM series, these devices are ideal for portable applications that require high-density board assembly such as cellular phones, IoT equipment and wearable devices.

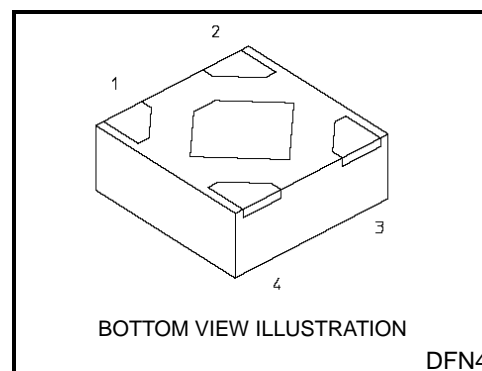

Weight: 1.3 mg (typ.)

Applications

Power IC developed for portable applications, IoT equipment and wearable devices

Features

- Ultra small package DFN4 (1.0 mm x 1.0 mm; t 0.60 mm (max)).
- Low quiescent bias current (I_B = 0.34 μ A (typ.) at I_{OUT} = 0 mA, output voltage up to 1.5 V)
- High Ripple rejection ratio 70 dB at 0.8 V-output
- Fast Load transient response -51/+36 mV at 0.8 V-output, I_{OUT} = 1 mA \leftrightarrow 50 mA
- Low Drop-Out voltage
VIN-V_{OUT} = 196 mV (typ.) at 3.3 V-output, I_{OUT} = 300 mA
- Wide range output voltage line up (V_{OUT} = 0.8 to 5.0 V)
- High V_{OUT} accuracy \pm 1.0 % (1.8 V \leq V_{OUT})
- Overcurrent protection
- Thermal Shutdown function
- Auto-discharge
- Inrush current protection circuit
- Pull down connection between CONTROL and GND
- Ceramic capacitors can be used (C_{IN} = 1 μ F, C_{OUT} = 1 μ F)

Start of commercial production
2018-08

Absolute Maximum Ratings (Ta = 25°C)

Characteristics	Symbol	Rating	Unit
Input voltage	V _{IN}	-0.3 to 6.0	V
Control voltage	V _{CT}	-0.3 to V _{IN} + 0.3 ≤ 6.0	V
Output voltage	V _{OUT}	-0.3 to V _{IN} + 0.3 ≤ 6.0	V
Power dissipation	P _D	420 (Note1)	mW
Junction temperature	T _j	150	°C
Storage temperature range	T _{stg}	-55 to 150	°C

Note: Using continuously under heavy loads (e.g. the application of high temperature/current/voltage and the significant change in temperature, etc.) may cause this product to decrease in the reliability significantly even if the operating conditions (i.e. operating temperature/current/voltage, etc.) are within the absolute maximum ratings and the operating ranges.

Please design the appropriate reliability upon reviewing the Toshiba Semiconductor Reliability Handbook ("Handling Precautions"/"Derating Concept and Methods") and individual reliability data (i.e. reliability test report and estimated failure rate, etc).

Note1: Rating at mounting on a board

Glass epoxy (FR4) board dimension: 40 mm x 40 mm (both sides of board), t = 1.6 mm

Metal pattern ratio: a surface approximately 50 %, the reverse side approximately 50 %

Through hole : diameter 0.5 mm x 24

Operating Ranges

Characteristics	Symbol	Rating	Unit
Input voltage	V _{IN}	1.5 to 5.5 (Note 2)	V
Control voltage	V _{CT}	0 to V _{IN}	V
Output voltage	V _{OUT}	0.8 to 5.0	V
Output current	I _{OUT}	DC 300 (Note 3)	mA
Operation Temperature	T _{opr}	-40 to 85	°C
Output Capacitance	C _{OUT}	≥ 1.0 μF	—
Input Capacitance	C _{IN}	≥ 1.0 μF	—

Note 2: I_{OUT} = 1 mA.

Please refer to Dropout Voltage (Page 13) and use it within Absolute Maximum Ratings Junction temperature and Operation Temperature Ranges.

Note 3: Do not operate at or near the maximum ratings of operating ranges for extended periods of time. Exposure to such conditions may adversely impact product reliability and results in failures not covered by warranty.

Pin Assignment (top view)

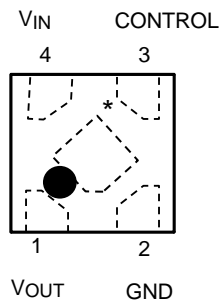

*Center electrode should be connected to GND or Open

List of Products Number, Output voltage and Marking

Product No.	Output voltage(V)	Auto dis-charge	Marking
TCR3UM08A	0.8	Yes	0R8
TCR3UM085A	0.85		0RA
TCR3UM09A	0.9		0R9
TCR3UM095A	0.95		0RB
TCR3UM10A	1.0		1R0
TCR3UM105A	1.05		1RC
TCR3UM11A	1.1		1R1
TCR3UM115A	1.15		1RE
TCR3UM12A	1.2		1R2
TCR3UM13A	1.3		1R3
TCR3UM135A	1.35		1RF
TCR3UM14A	1.4		1R4
TCR3UM15A	1.5		1R5
TCR3UM16A	1.6		1R6
TCR3UM175A	1.75		1RG
TCR3UM18A	1.8		1R8
TCR3UM1825A	1.825		1RH
TCR3UM185A	1.85		1RJ
TCR3UM19A	1.9		1R9
TCR3UM25A	2.5		2R5
TCR3UM26A	2.6		2R6
TCR3UM27A	2.7		2R7
TCR3UM28A	2.8		2R8
TCR3UM285A	2.85		2RK
TCR3UM29A	2.9		2R9
TCR3UM2925A	2.925		2RL
TCR3UM30A	3.0		3R0
TCR3UM31A	3.1		3R1
TCR3UM32A	3.2		3R2
TCR3UM33A	3.3		3R3
TCR3UM35A	3.5	3R5	
TCR3UM36A	3.6	3R6	
TCR3UM41A	4.1	4R1	
TCR3UM42A	4.2	4R2	
TCR3UM45A	4.5	4R5	
TCR3UM50A	5.0	5R0	

Top Marking (top view)

Example: TCR3UM33A (3.3 V output)

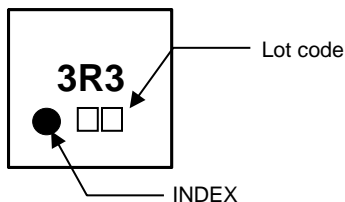

Block Diagram

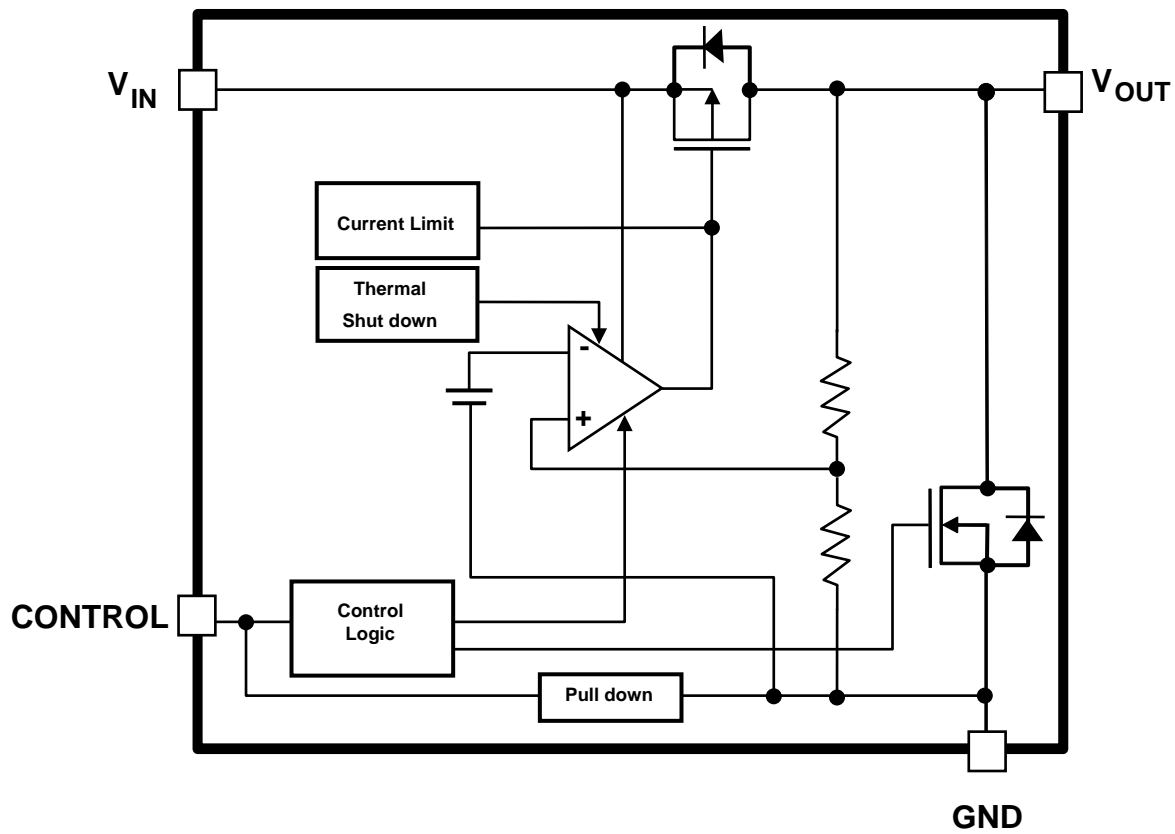

Electrical Characteristics

(Unless otherwise specified,

$V_{IN} = V_{OUT} + 1\text{ V}$ ($V_{OUT} > 1.5\text{ V}$), $V_{IN} = 2.5\text{ V}$ ($V_{OUT} \leq 1.5\text{ V}$), $I_{OUT} = 50\text{ mA}$, $C_{IN} = C_{OUT} = 1\text{ }\mu\text{F}$)

Characteristics	Symbol	Test Condition	$T_j = 25^\circ\text{C}$			$T_j = -40\text{ to }85^\circ\text{C}$ (Note 9)		Unit	
			Min	Typ.	Max	Min	Max		
Output voltage	V_{OUT}	$I_{OUT} = 50\text{ mA}$ (Note 4)	$V_{OUT} < 1.8\text{ V}$	-18	—	+18	—	—	mV
			$1.8\text{ V} \leq V_{OUT}$	-1.0	—	+1.0	—	—	%
Input voltage	V_{IN}	$I_{OUT} = 1\text{ mA}$	1.5	—	5.5	1.5	5.5	V	
Line regulation	Reg. line	$I_{OUT} = 1\text{ mA}$ (Note 5)	—	1	15	—	—	mV	
Load regulation	Reg. load	$1\text{ mA} \leq I_{OUT} \leq 300\text{ mA}$ (Note 6)	—	17	30	—	—	mV	
Quiescent current	$I_{B(ON1)}$	$I_{OUT} = 0\text{ mA}$, $V_{OUT} \leq 1.5\text{ V}$ (Note 7)	—	0.34	—	—	0.58	μA	
	$I_{B(ON2)}$	$I_{OUT} = 0\text{ mA}$, $1.75\text{ V} \leq V_{OUT} \leq 5\text{ V}$ (Note 7)	—	0.38	—	—	0.68	μA	
Stand-by current	$I_{B(OFF1)}$	$V_{CT} = 0\text{ V}$, $V_{IN} = 2.5\text{ V}$	—	0.03	—	—	0.16	μA	
	$I_{B(OFF2)}$	$V_{CT} = 0\text{ V}$, $V_{IN} = 5.5\text{ V}$	—	0.03	—	—	0.20	μA	
Control pull down current	I_{CT}	—	—	0.1	—	—	—	μA	
Drop-out voltage	V_{DO}	$I_{OUT} = 300\text{ mA}$	$V_{OUT} = 1.8\text{ V}$	—	336	—	—	457	mV
			$V_{OUT} = 3.3\text{ V}$	—	196	—	—	273	mV
Output current limit	I_{CL}	$V_{OUT} = V_{OUT(NOM)} * 90\%$ (Note 9)	—	545	—	400	—	mA	
Output noise voltage	V_{NO}	$I_{OUT} = 10\text{ mA}$, $10\text{ Hz} \leq f \leq 100\text{ kHz}$, $T_a = 25^\circ\text{C}$ (Note 6)	—	41	—	—	—	μV_{rms}	
Ripple rejection ratio	R.R.	$I_{OUT} = 10\text{ mA}$, $f = 1\text{ kHz}$, $V_{Ripple} = 200\text{ mV}_{p-p}$, $T_a = 25^\circ\text{C}$ (Note 6)	—	70	—	—	—	dB	
Load transient response	ΔV_{OUT}	$I_{OUT} = 1\text{ mA} \rightarrow 50\text{ mA}$ (Note 8)	—	-51	—	—	—	mV	
		$I_{OUT} = 50\text{ mA} \rightarrow 1\text{ mA}$ (Note 8)	—	+36	—	—	—	mV	
Temperature coefficient	T_{CVO}	$-40^\circ\text{C} \leq T_{opr} \leq 85^\circ\text{C}$	—	75	—	—	—	ppm/ $^\circ\text{C}$	
Control voltage (ON)	$V_{CT(ON)}$	—	1.0	—	5.5	1.0	5.5	V	
Control voltage (OFF)	$V_{CT(OFF)}$	—	0	—	0.4	0	0.4	V	
Discharge on resistance	RSD	—	—	7	—	—	—	Ω	
Thermal shutdown temperature	T_{SD}	(Note 9) (Note 10)	—	158	—	—	—	$^\circ\text{C}$	
Thermal shutdown hysteresis	T_{SDH}	(Note 9) (Note 10)	—	28	—	—	—	$^\circ\text{C}$	

Note 4: stable state with fixed I_{OUT} condition

Note 5: $V_{OUT} \leq 1.5\text{ V}$, $2.5\text{ V} \leq V_{IN} \leq 5.5\text{ V}$

$1.75\text{ V} \leq V_{OUT} \leq 4.2\text{ V}$, $V_{OUT} + 1\text{ V} \leq V_{IN} \leq 5.5\text{ V}$

$V_{OUT} = 4.5\text{ V}$, $V_{OUT} = 5.0\text{ V}$, not applicable

Note 6: $V_{OUT} = 0.8\text{ V}$

Note 7: except Control pull down current (I_{CT})

Note 8: $V_{OUT} = 0.8\text{ V}$, $V_{IN} = 3.3\text{ V}$

Note 9: This parameter is warranted by design

Note 10: $V_{OUT} = 0.8\text{ V}$, $V_{IN} = 2.5\text{ V}$

Drop-out voltage

($I_{OUT} = 300 \text{ mA}$, $C_{IN} = C_{OUT} = 1 \mu\text{F}$)

Output voltages	Symbol	Min	Typ. $T_j = 25^\circ\text{C}$	Max (Note 11)	Unit
$0.8 \text{ V} \leq V_{OUT} < 0.9 \text{ V}$	$V_{IN-V_{OUT}}$	—	1020	1257	mV
$0.9 \text{ V} \leq V_{OUT} < 1.0 \text{ V}$		—	933	1157	
$1.0 \text{ V} \leq V_{OUT} < 1.1 \text{ V}$		—	848	1057	
$1.1 \text{ V} \leq V_{OUT} < 1.2 \text{ V}$		—	760	957	
$1.2 \text{ V} \leq V_{OUT} < 1.3 \text{ V}$		—	667	857	
$1.3 \text{ V} \leq V_{OUT} < 1.5 \text{ V}$		—	580	757	
$1.5 \text{ V} \leq V_{OUT} < 1.6 \text{ V}$		—	462	617	
$1.6 \text{ V} \leq V_{OUT} < 1.8 \text{ V}$		—	420	537	
$1.8 \text{ V} \leq V_{OUT} < 2.0 \text{ V}$		—	336	457	
$2.0 \text{ V} \leq V_{OUT} < 2.5 \text{ V}$		—	292	405	
$2.5 \text{ V} \leq V_{OUT} < 3.0 \text{ V}$		—	216	327	
$3.0 \text{ V} \leq V_{OUT} < 3.6 \text{ V}$		—	196	273	
$3.6 \text{ V} \leq V_{OUT} < 4.5 \text{ V}$		—	174	232	
$4.5 \text{ V} \leq V_{OUT} \leq 5.0 \text{ V}$		—	149	210	

Note 11: $T_j = -40$ to 85°C . This parameter is warranted by design

Application Note

1. Recommended Application Circuit

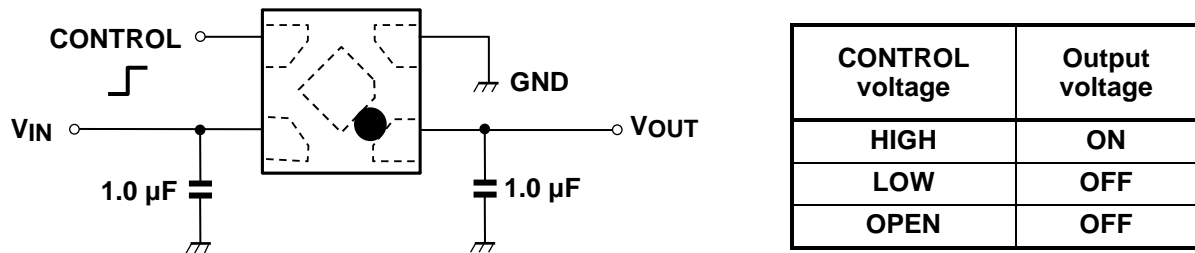

The figure above shows the recommended configuration for using a Low-Dropout regulator. Insert a capacitor at V_{OUT} and V_{IN} pins for stable input/output operation. (Ceramic capacitors can be used).

2. Power Dissipation

Board-mounted power dissipation ratings for TCR3UM series are available in the Absolute Maximum Ratings table. Power dissipation is measured on the board condition shown below.

[The Board Condition]

Board material: Glass epoxy (FR4)

Board dimension: 40 mm x 40 mm (both sides of board), $t = 1.6$ mm

Metal pattern ratio: a surface approximately 50 %, the reverse side approximately 50 %

Through hole hall: diameter 0.5 mm x 24

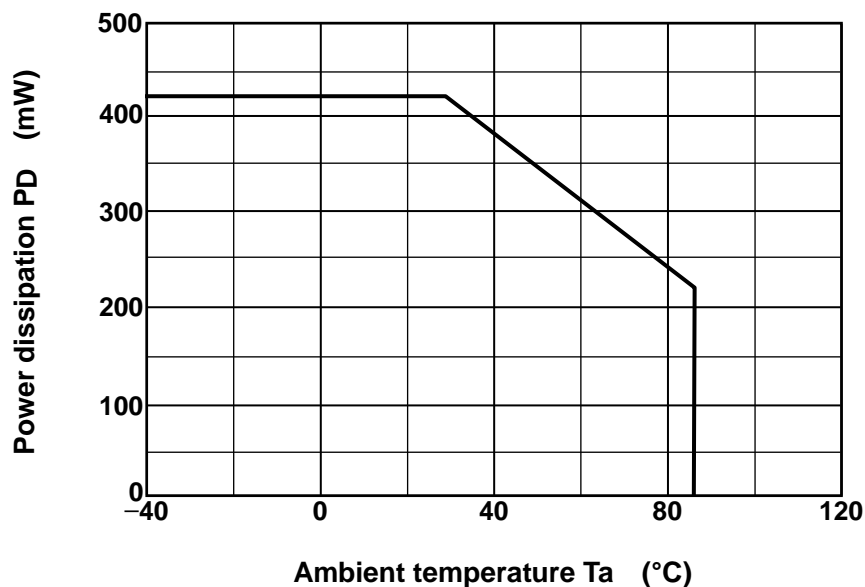

Attention in Use

- **Output Capacitors**
Ceramic capacitors can be used for these devices. However, because of the type of the capacitors, there might be unexpected thermal features. Please consider application condition for selecting capacitors. And Toshiba recommend the ESR of ceramic capacitor is under 10 Ω . For stable operation, we recommend over 1 μF .
- **Mounting**
The long distance between IC and input output capacitor might affect phase compensation by impedance in wire and inductor. For stable power supply, input output capacitor need to mount near IC as much as possible. Also VIN and GND pattern need to be large and make the wire impedance small as possible.
- **Permissible Loss**
Please have enough design patterns for expected maximum permissible loss. And under consideration of ambient temperature, input voltage, and output current etc., we recommend proper dissipation ratings for maximum permissible loss; in general maximum dissipation rating is 70 to 80 %.
- **Over current Protection and Thermal shut down function**
Over current protection and Thermal shut down function are designed in these products, but these are not designed to constantly ensure the suppression of the device within operation limits. Depending on the condition during actual usage, it could affect the electrical characteristic specification and reliability. Also note that if output pins and GND pins are not completely shorted out, these products might break down.
When using these products, please read through and understand the concept of dissipation for absolute maximum ratings from the above mention or our 'Semiconductor Reliability Handbook'. Then use these products under absolute maximum ratings in any condition. Furthermore, Toshiba recommends inserting failsafe system into the design.

Representative Typical Characteristics Output Voltage vs. Input Voltage

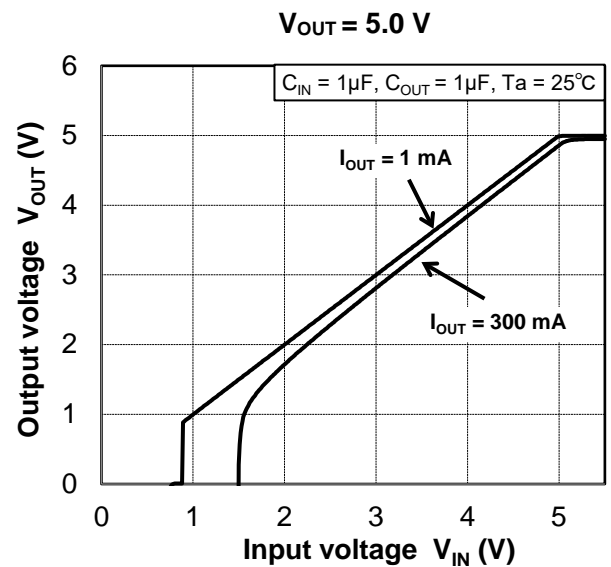
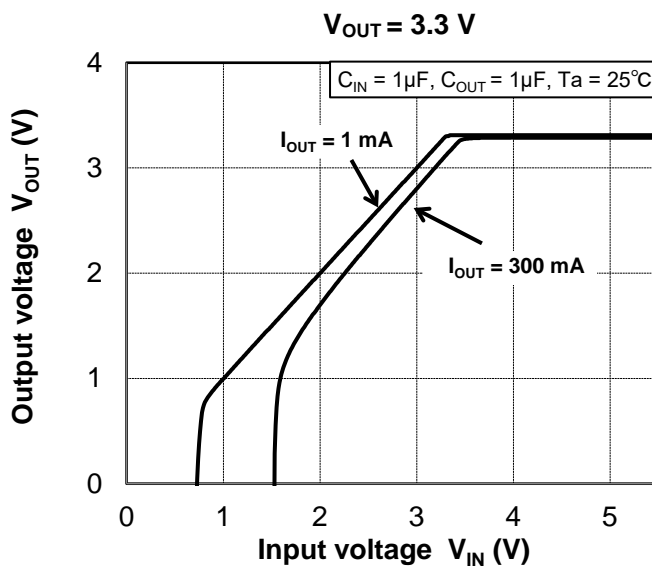
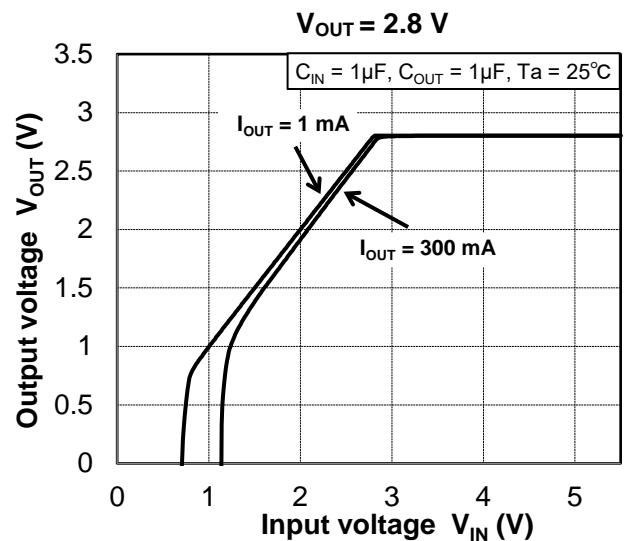
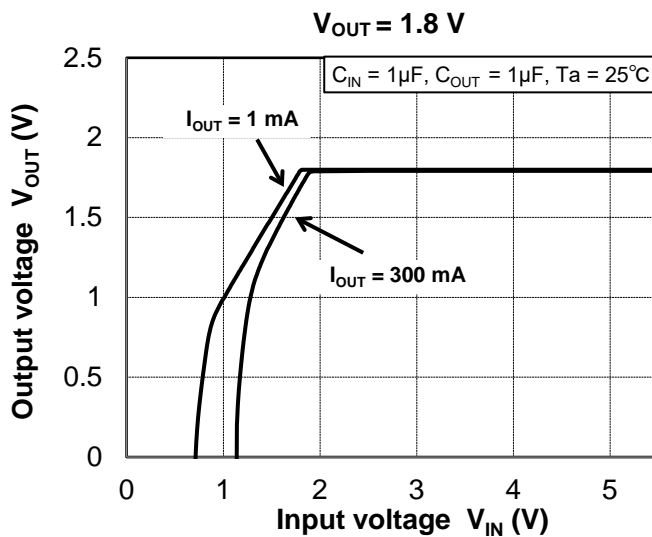
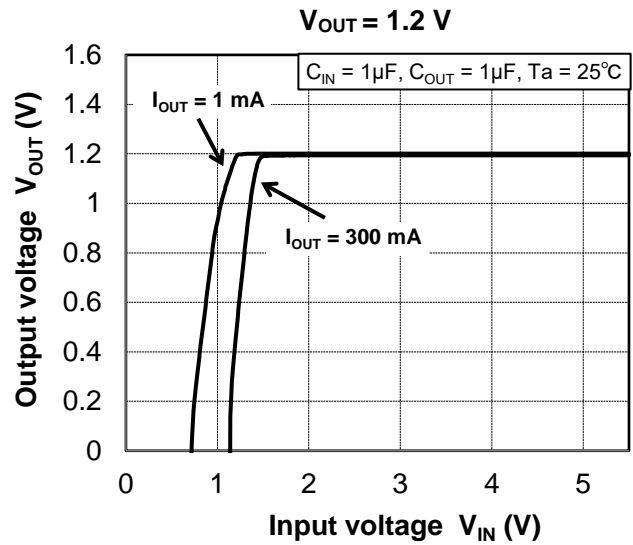
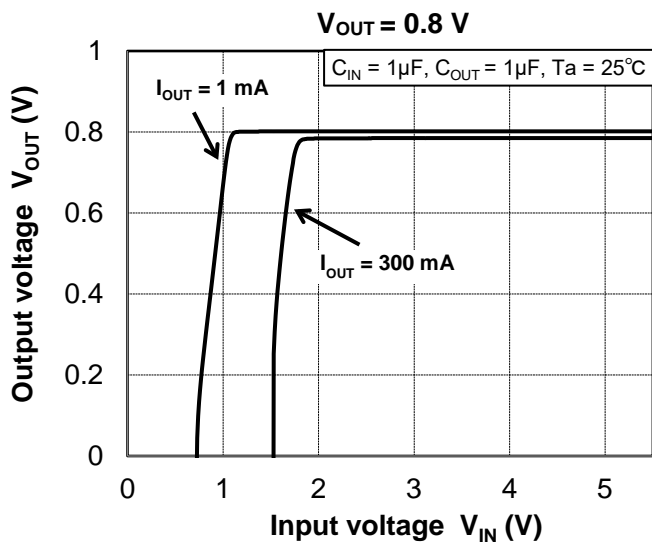

Quiescent Current vs. Output Current

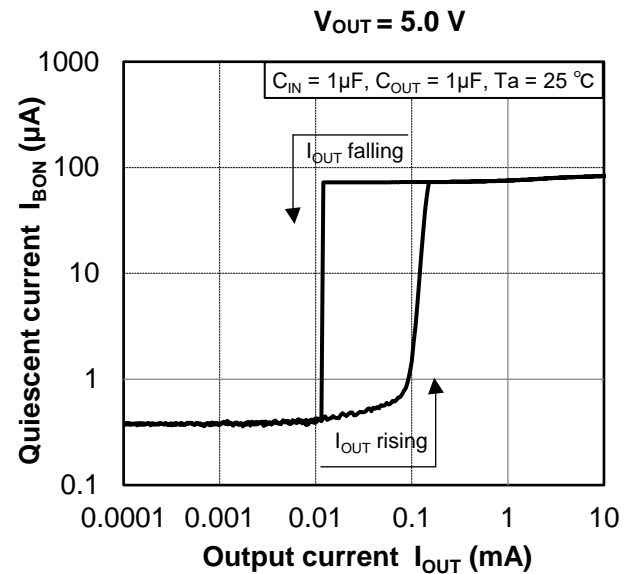
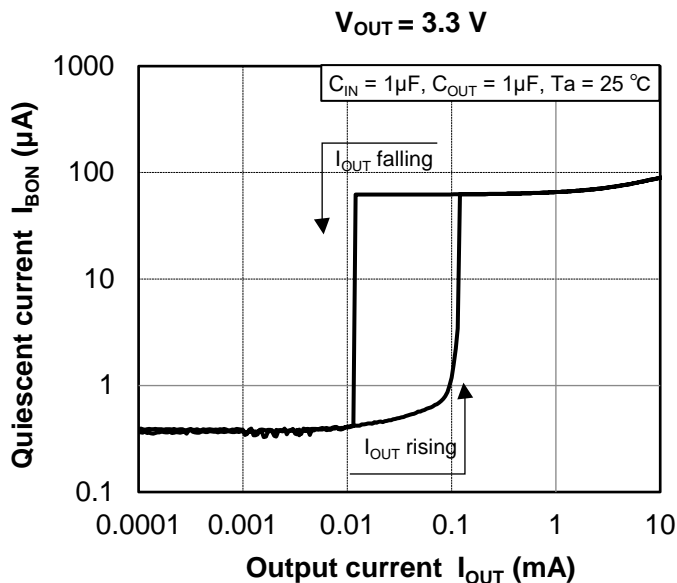
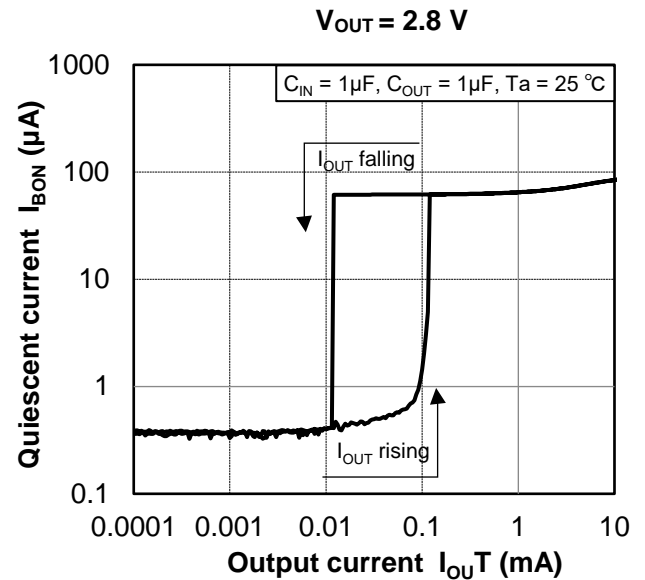
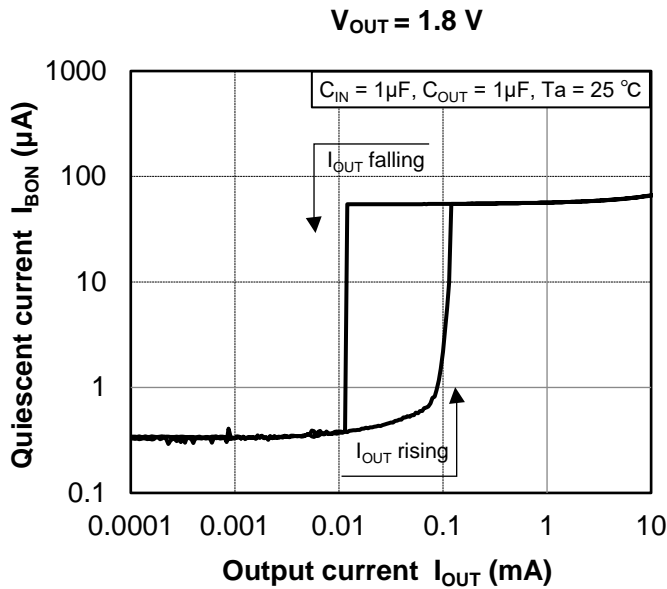
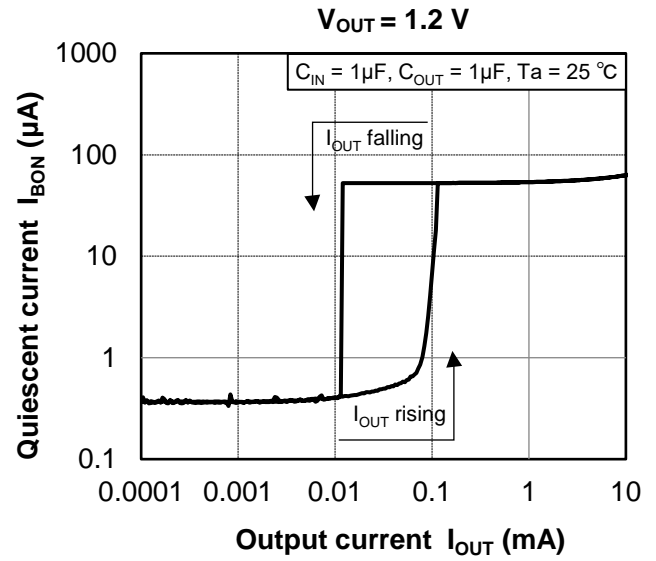
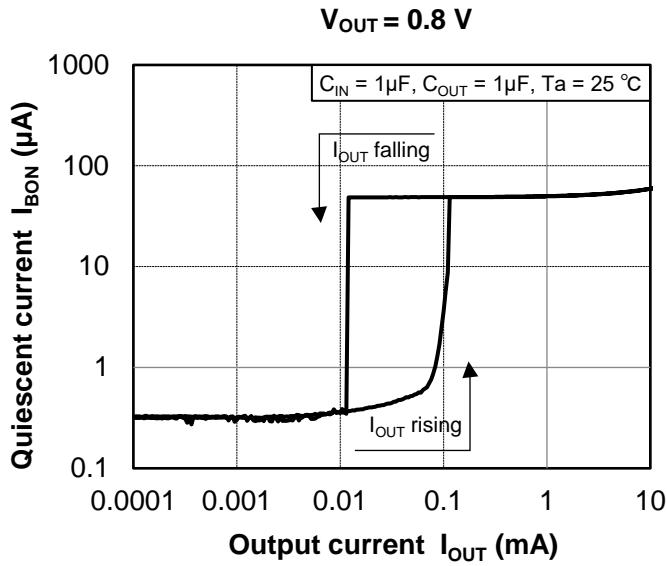

Quiescent Current vs. Input Voltage

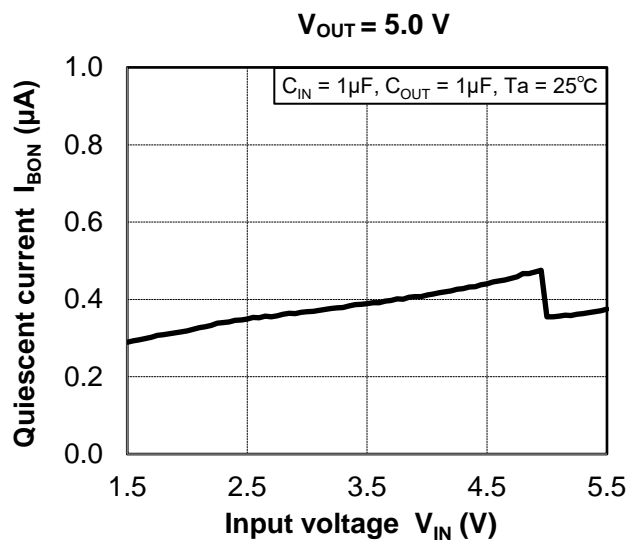
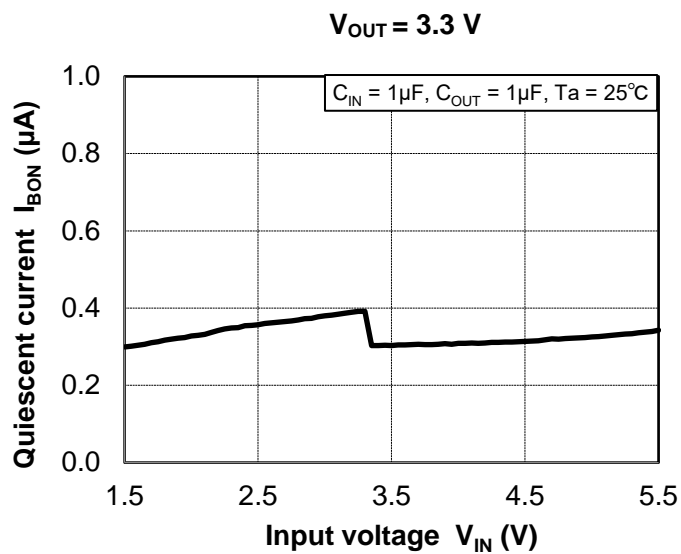
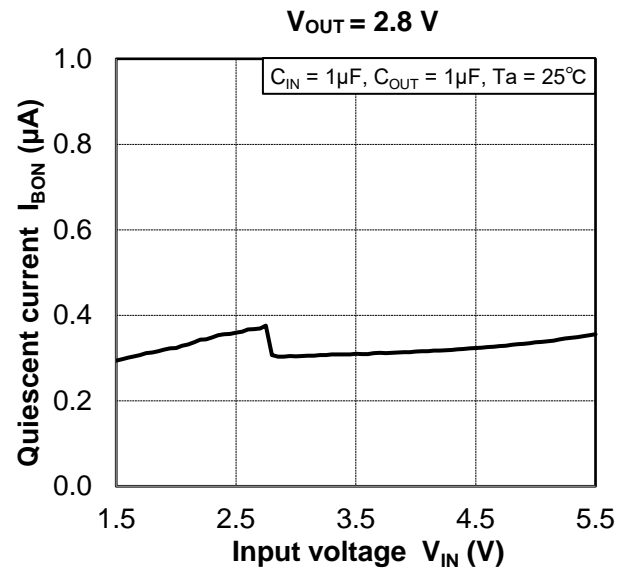
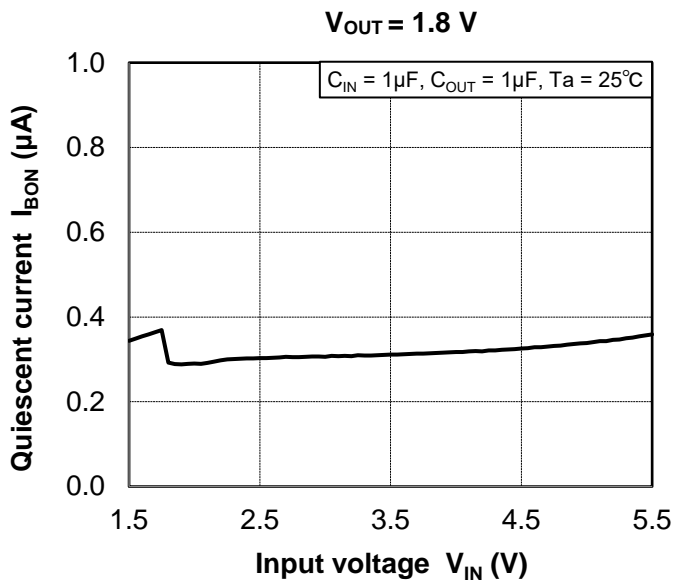
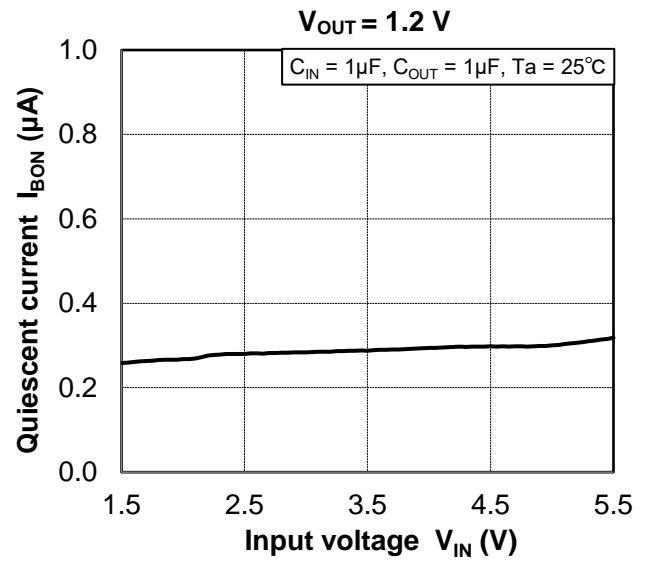
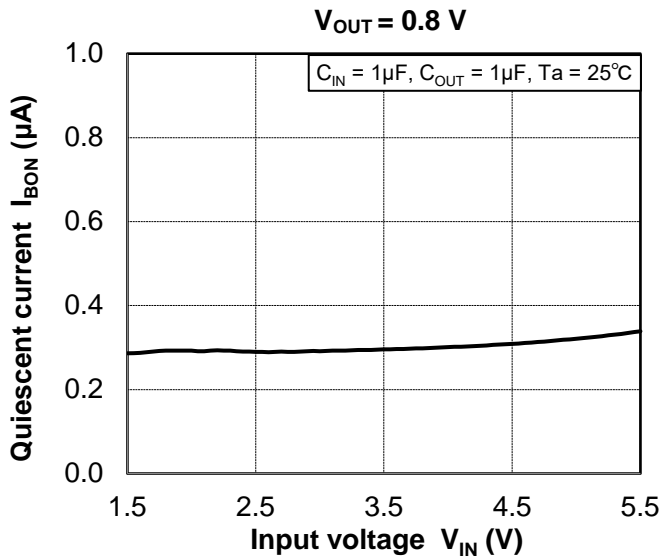

Dropout Voltage vs. Output Current

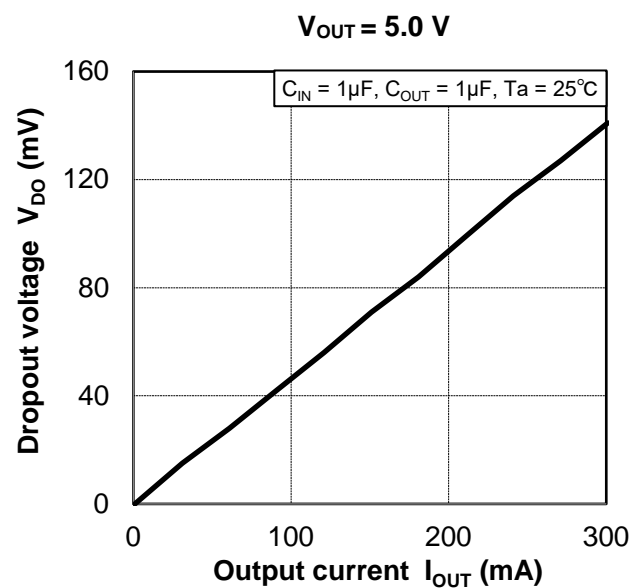
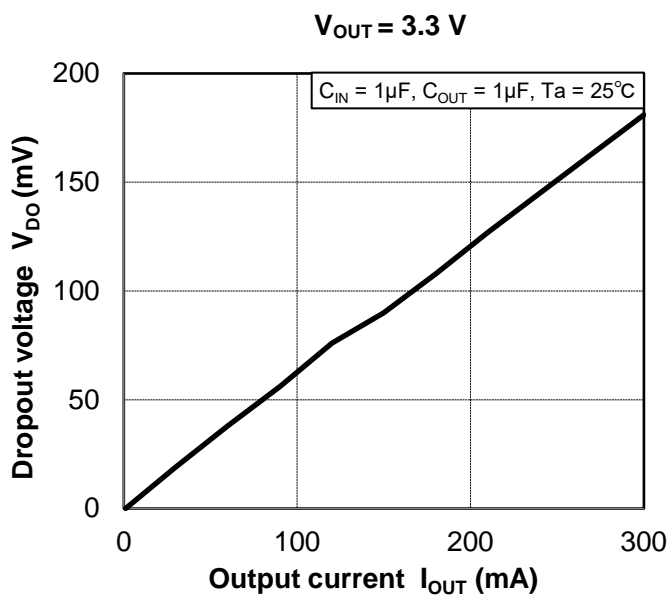
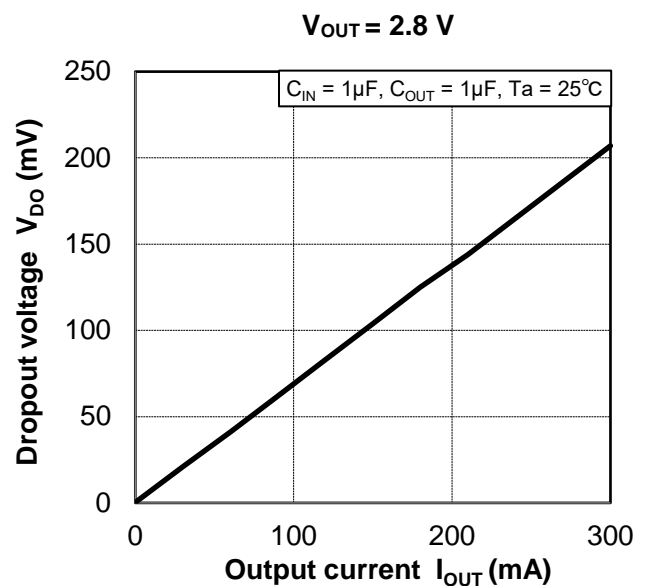
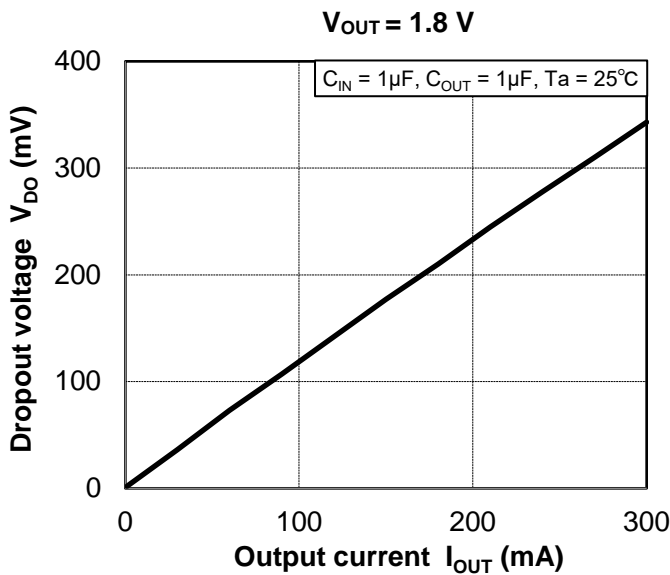
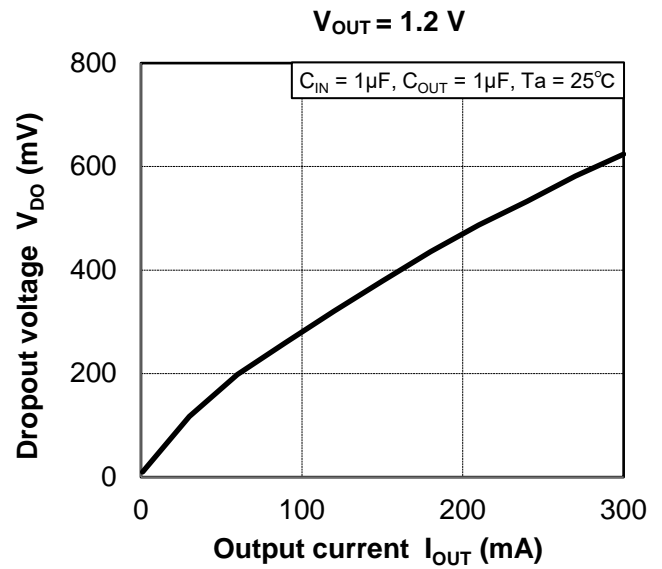
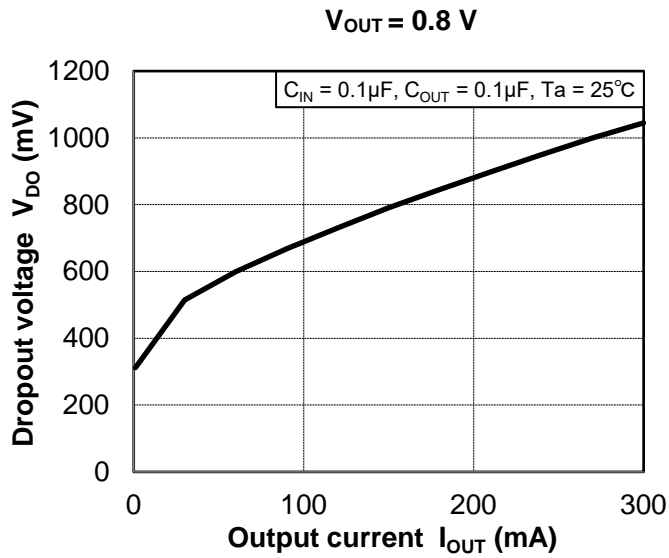

Ripple Rejection Ratio vs. Frequency

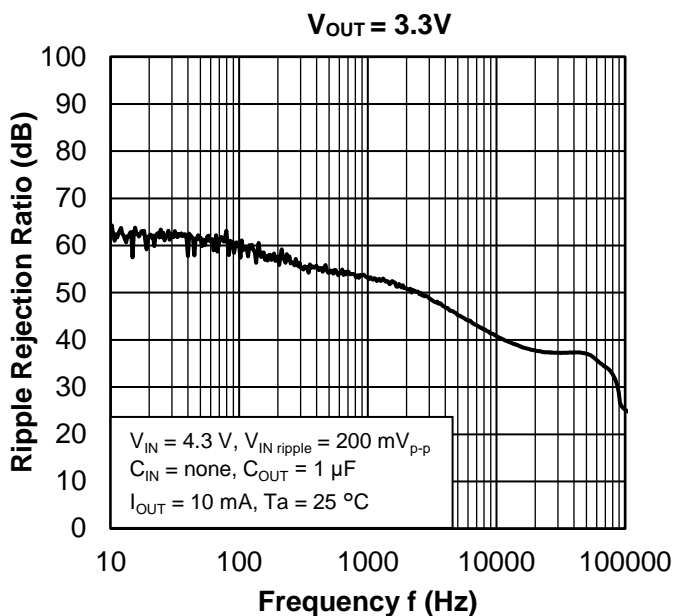
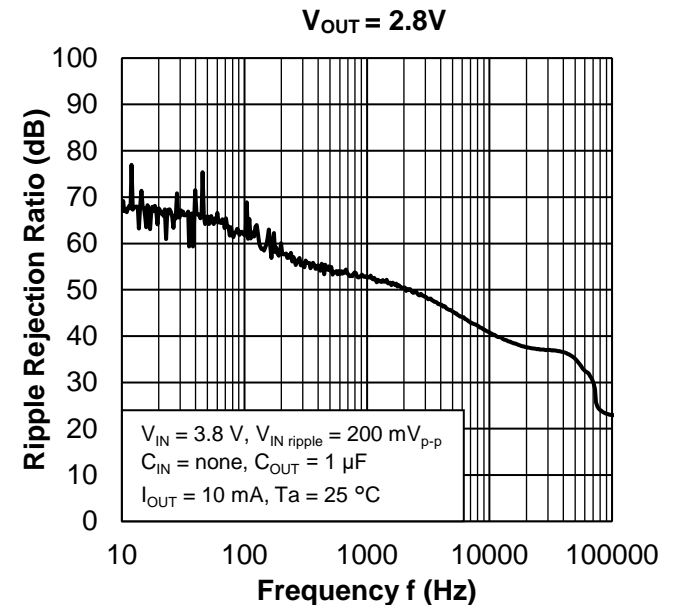
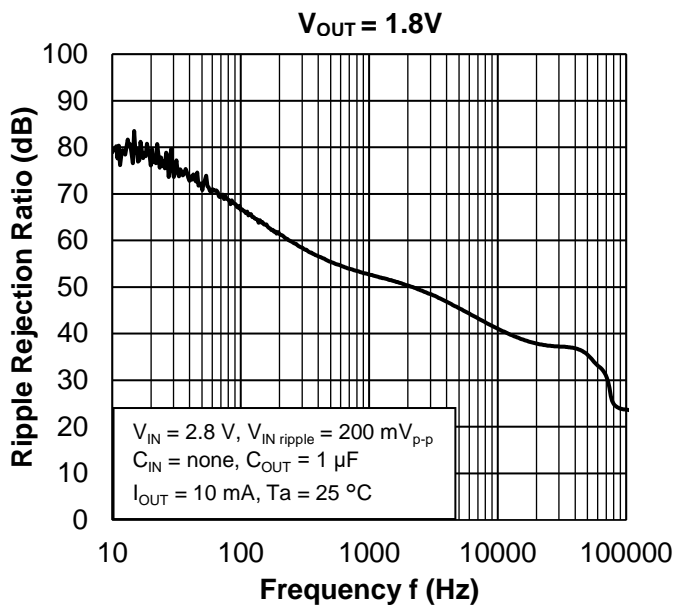
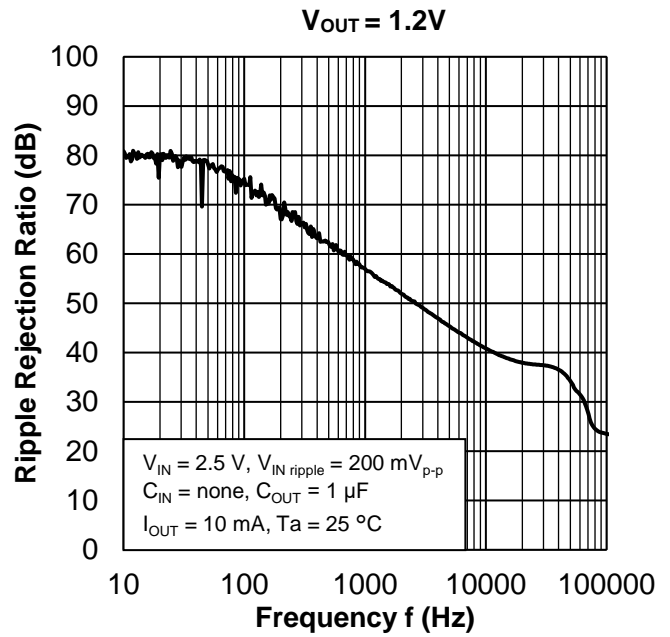
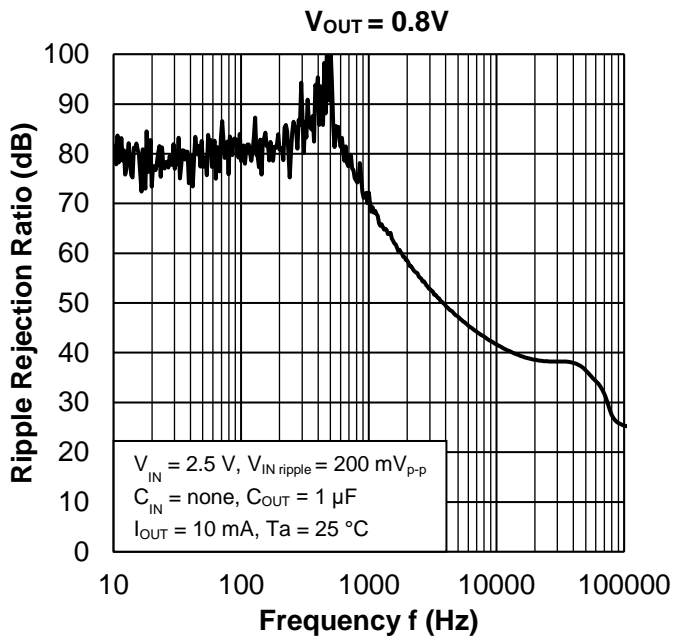

Load Transient Response

V_{OUT} = 0.8V

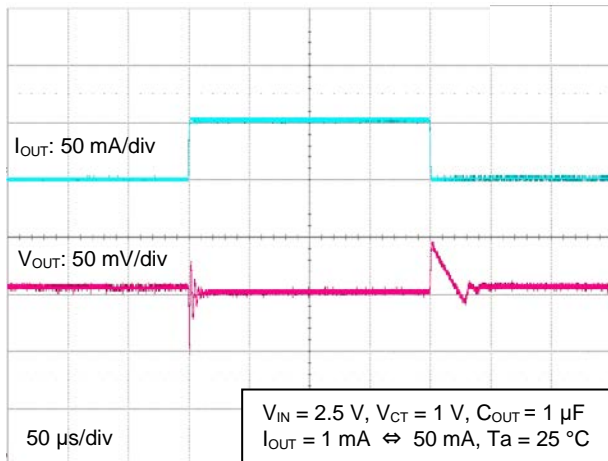

V_{OUT} = 1.2V

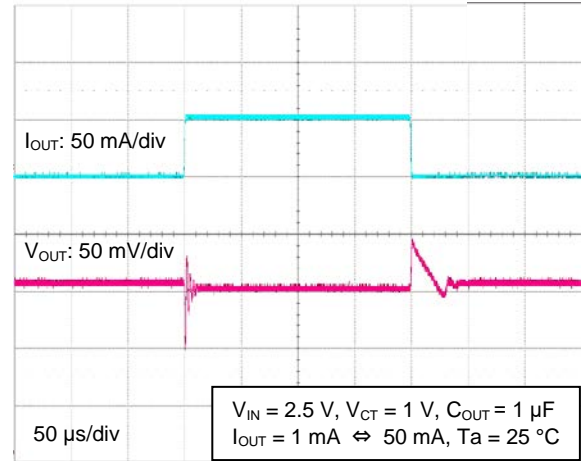

V_{OUT} = 1.8V

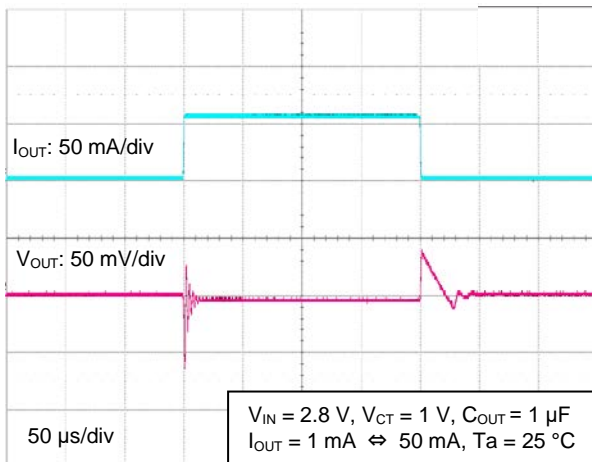

V_{OUT} = 2.8V

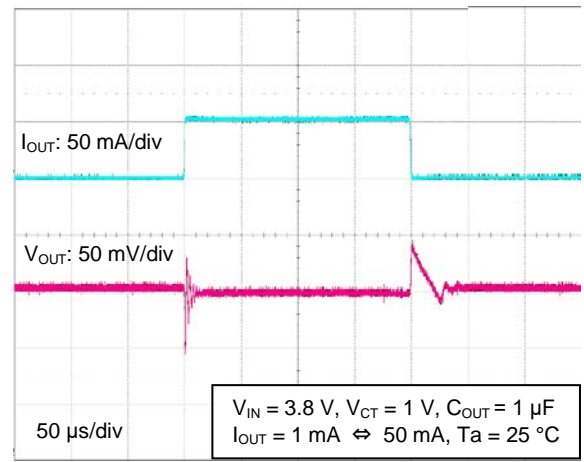

V_{OUT} = 3.3V

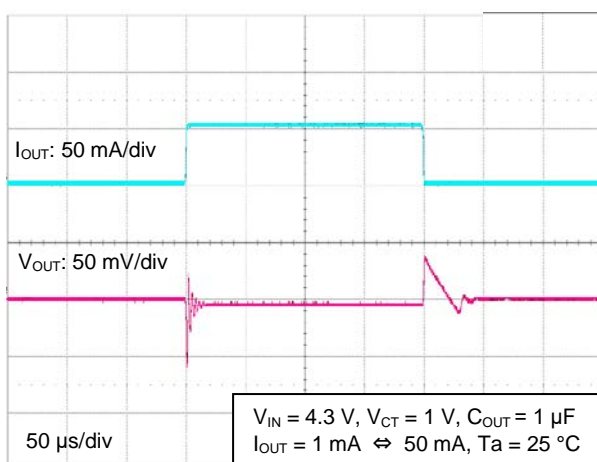

V_{OUT} = 5.0V

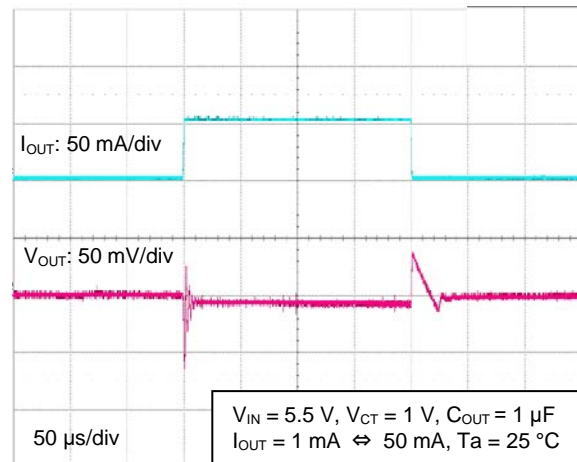

t_{ON} Response

$V_{OUT} = 2.8V$

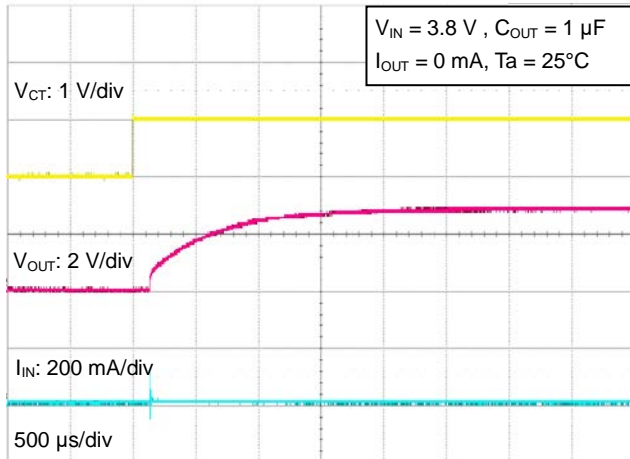

$V_{OUT} = 2.8V$

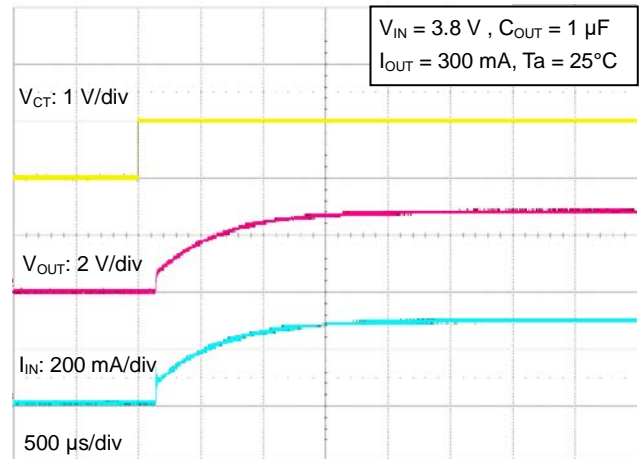

t_{OFF} Response (Auto-discharge)

$V_{OUT} = 2.8V$

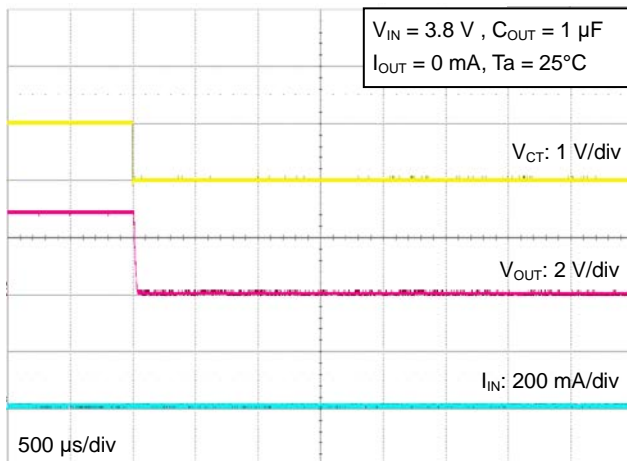

$V_{OUT} = 2.8V$

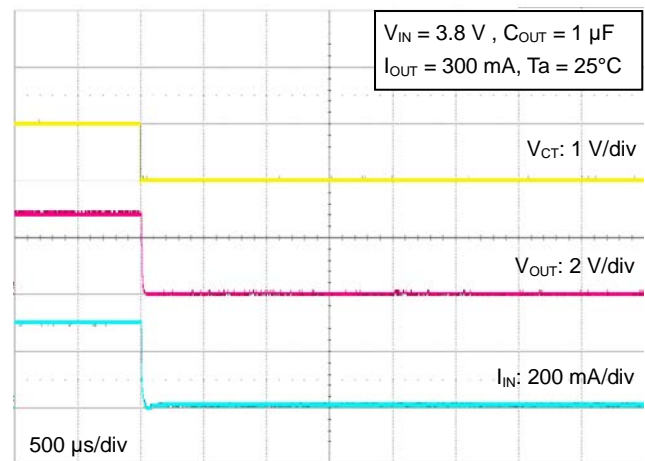

Note: The above characteristics curves are presented for reference only and not guaranteed by production test, unless otherwise noted.

Package Information

DFN4

Unit : mm

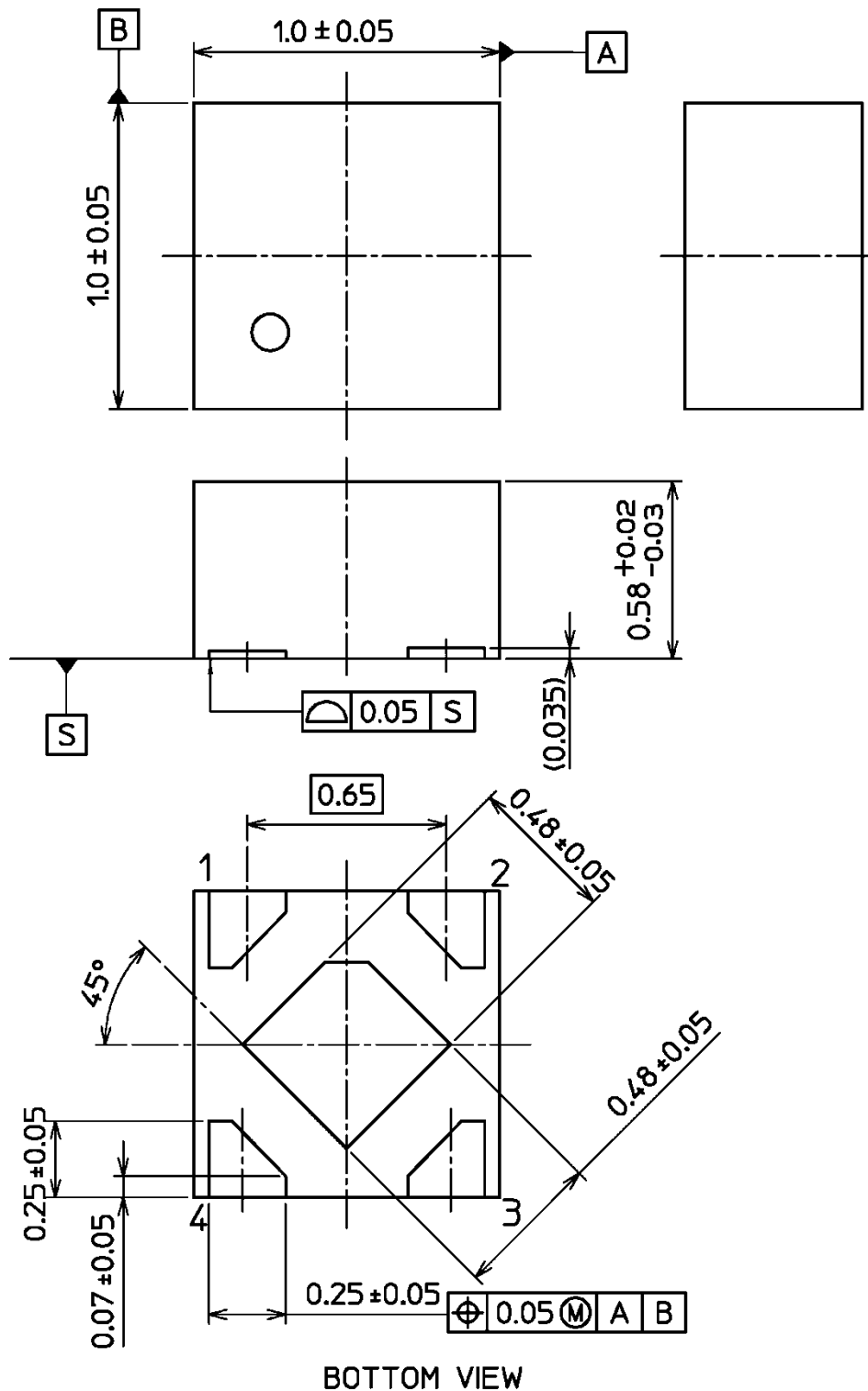

0.04 mm (typ.) unevenness exists along the edges of the back electrode to increase shear after soldering.

Weight: 1.3 mg (typ.)

RESTRICTIONS ON PRODUCT USE

Toshiba Corporation and its subsidiaries and affiliates are collectively referred to as "TOSHIBA". Hardware, software and systems described in this document are collectively referred to as "Product".

- TOSHIBA reserves the right to make changes to the information in this document and related Product without notice.
- This document and any information herein may not be reproduced without prior written permission from TOSHIBA. Even with TOSHIBA's written permission, reproduction is permissible only if reproduction is without alteration/omission.
- Though TOSHIBA works continually to improve Product's quality and reliability, Product can malfunction or fail. Customers are responsible for complying with safety standards and for providing adequate designs and safeguards for their hardware, software and systems which minimize risk and avoid situations in which a malfunction or failure of Product could cause loss of human life, bodily injury or damage to property, including data loss or corruption. Before customers use the Product, create designs including the Product, or incorporate the Product into their own applications, customers must also refer to and comply with (a) the latest versions of all relevant TOSHIBA information, including without limitation, this document, the specifications, the data sheets and application notes for Product and the precautions and conditions set forth in the "TOSHIBA Semiconductor Reliability Handbook" and (b) the instructions for the application with which the Product will be used with or for. Customers are solely responsible for all aspects of their own product design or applications, including but not limited to (a) determining the appropriateness of the use of this Product in such design or applications; (b) evaluating and determining the applicability of any information contained in this document, or in charts, diagrams, programs, algorithms, sample application circuits, or any other referenced documents; and (c) validating all operating parameters for such designs and applications. **TOSHIBA ASSUMES NO LIABILITY FOR CUSTOMERS' PRODUCT DESIGN OR APPLICATIONS.**
- **PRODUCT IS NEITHER INTENDED NOR WARRANTED FOR USE IN EQUIPMENTS OR SYSTEMS THAT REQUIRE EXTRAORDINARILY HIGH LEVELS OF QUALITY AND/OR RELIABILITY, AND/OR A MALFUNCTION OR FAILURE OF WHICH MAY CAUSE LOSS OF HUMAN LIFE, BODILY INJURY, SERIOUS PROPERTY DAMAGE AND/OR SERIOUS PUBLIC IMPACT ("UNINTENDED USE").** Except for specific applications as expressly stated in this document, Unintended Use includes, without limitation, equipment used in nuclear facilities, equipment used in the aerospace industry, lifesaving and/or life supporting medical equipment, equipment used for automobiles, trains, ships and other transportation, traffic signaling equipment, equipment used to control combustions or explosions, safety devices, elevators and escalators, and devices related to power plant. **IF YOU USE PRODUCT FOR UNINTENDED USE, TOSHIBA ASSUMES NO LIABILITY FOR PRODUCT.** For details, please contact your TOSHIBA sales representative or contact us via our website.
- Do not disassemble, analyze, reverse-engineer, alter, modify, translate or copy Product, whether in whole or in part.
- Product shall not be used for or incorporated into any products or systems whose manufacture, use, or sale is prohibited under any applicable laws or regulations.
- The information contained herein is presented only as guidance for Product use. No responsibility is assumed by TOSHIBA for any infringement of patents or any other intellectual property rights of third parties that may result from the use of Product. No license to any intellectual property right is granted by this document, whether express or implied, by estoppel or otherwise.
- **ABSENT A WRITTEN SIGNED AGREEMENT, EXCEPT AS PROVIDED IN THE RELEVANT TERMS AND CONDITIONS OF SALE FOR PRODUCT, AND TO THE MAXIMUM EXTENT ALLOWABLE BY LAW, TOSHIBA (1) ASSUMES NO LIABILITY WHATSOEVER, INCLUDING WITHOUT LIMITATION, INDIRECT, CONSEQUENTIAL, SPECIAL, OR INCIDENTAL DAMAGES OR LOSS, INCLUDING WITHOUT LIMITATION, LOSS OF PROFITS, LOSS OF OPPORTUNITIES, BUSINESS INTERRUPTION AND LOSS OF DATA, AND (2) DISCLAIMS ANY AND ALL EXPRESS OR IMPLIED WARRANTIES AND CONDITIONS RELATED TO SALE, USE OF PRODUCT, OR INFORMATION, INCLUDING WARRANTIES OR CONDITIONS OF MERCHANTABILITY, FITNESS FOR A PARTICULAR PURPOSE, ACCURACY OF INFORMATION, OR NONINFRINGEMENT.**
- Do not use or otherwise make available Product or related software or technology for any military purposes, including without limitation, for the design, development, use, stockpiling or manufacturing of nuclear, chemical, or biological weapons or missile technology products (mass destruction weapons). Product and related software and technology may be controlled under the applicable export laws and regulations including, without limitation, the Japanese Foreign Exchange and Foreign Trade Law and the U.S. Export Administration Regulations. Export and re-export of Product or related software or technology are strictly prohibited except in compliance with all applicable export laws and regulations.
- Please contact your TOSHIBA sales representative for details as to environmental matters such as the RoHS compatibility of Product. Please use Product in compliance with all applicable laws and regulations that regulate the inclusion or use of controlled substances, including without limitation, the EU RoHS Directive. **TOSHIBA ASSUMES NO LIABILITY FOR DAMAGES OR LOSSES OCCURRING AS A RESULT OF NONCOMPLIANCE WITH APPLICABLE LAWS AND REGULATIONS.**

X-ON Electronics

Largest Supplier of Electrical and Electronic Components

Click to view similar products for [LDO Voltage Regulators](#) category:

Click to view products by [Toshiba](#) manufacturer:

Other Similar products are found below :

[AP7363-SP-13](#) [L79M05TL-E](#) [TCR3DF185,LM\(CT](#) [TCR3DF24,LM\(CT](#) [TCR3DF285,LM\(CT](#) [TCR3DF31,LM\(CT](#) [TCR3DF45,LM\(CT](#)
[MP2013GQ-33-Z](#) [059985X](#) [NCP4687DH15T1G](#) [701326R](#) [TCR2EN28,LF\(S](#) [NCV8170AXV250T2G](#) [TCR3DF27,LM\(CT](#)
[TCR3DF19,LM\(CT](#) [TCR3DF125,LM\(CT](#) [TCR2EN18,LF\(S](#) [AP2112R5A-3.3TRG1](#) [AP7315-25W5-7](#) [IFX30081LDVGRNXUMA1](#)
[NCV47411PAAJR2G](#) [AP2113KTR-G1](#) [AP2111H-1.2TRG1](#) [ZLDO1117QK50TC](#) [AZ1117IH-1.8TRG1](#) [AZ1117ID-ADJTRG1](#)
[TCR3DG12,LF](#) [MIC5514-3.3YMT-T5](#) [MIC5512-1.2YMT-T5](#) [MIC5317-2.8YM5-T5](#) [SCD7912BTG](#) [NCP154MX180270TAG](#) [SCD33269T-](#)
[5.0G](#) [NCV8170BMX330TCG](#) [NCV8170AMX120TCG](#) [NCP706ABMX300TAG](#) [NCP153MX330180TCG](#) [NCP114BMX075TCG](#)
[MC33269T-3.5G](#) [CAT6243-ADJCMT5T](#) [TCR3DG33,LF](#) [AP2127N-1.0TRG1](#) [TCR4DG35,LF](#) [LT1117CST-3.3](#) [TAR5S15U\(TE85L,F\)](#)
[TAR5S18U\(TE85L,F\)](#) [TCR3UG19A,LF](#) [TCR4DG105,LF](#) [NCV8170AMX360TCG](#) [MIC94310-NYMT-T5](#)