

TLP127

Programmable Controllers
 DC-Output Module
 Telecommunication

The TOSHIBA mini flat coupler TLP127 is a small outline coupler, suitable for surface mount assembly. TLP127 consists of a gallium arsenide infrared emitting diode, optically coupled to a darlington photo transistor with an integral base-emitter resistor, and provides 300V VCEO.

- Collector-emitter voltage: 300 V (min.)
- Current transfer ratio: 1000% (min.)
- Isolation voltage: 2500Vrms (min.)
- UL recognized: UL1577, file no. E67349
- BSI approved: BS EN60065:2002, certificate no.8927
 BS EN60950-1:2002, certificate no.8928

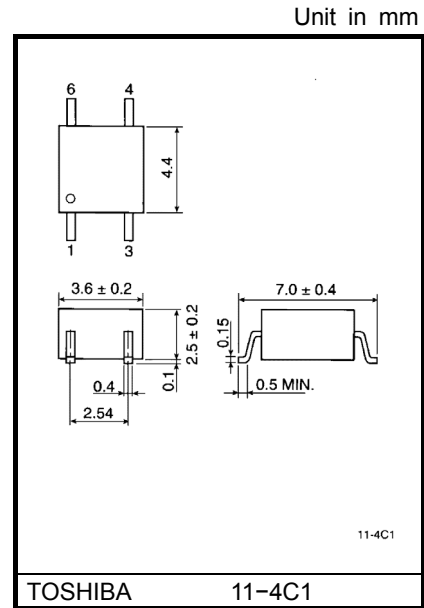

Weight: 0.09 g

Pin Configurations (top view)

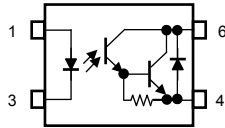

- 1: ANODE
- 3: CATHODE
- 4: EMITTER
- 6: COLLECTOR

Absolute Maximum Ratings (Ta = 25°C)

Characteristic		Symbol	Rating	Unit
LED	Forward current	I_F	50	mA
	Forward current derating	$\Delta I_F / ^\circ\text{C}$	-0.7 (Ta \geq 53°C)	mA / °C
	Pulse forward current	I_{FP}	1 (100 μ s pulse, 100pps)	A
	Reverse voltage	V_R	5	V
	Junction temperature	T_j	125	°C
Detector	Collector-emitter voltage	V_{CEO}	300	V
	Emitter-collector voltage	V_{ECO}	0.3	V
	Collector current	I_C	150	mA
	Collector power dissipation	P_C	150	mW
	Collector power dissipation derating (Ta \geq 25°C)	$\Delta P_C / ^\circ\text{C}$	-1.5	mW / °C
	Junction temperature	T_j	125	°C
Storage temperature range		T_{stg}	-55~125	°C
Operating temperature range		T_{opr}	-55~100	°C
Lead soldering temperature		T_{sol}	260 (10s)	°C
Total package power dissipation		P_T	200	mW
Total package power dissipation derating (Ta \geq 25°C)		$\Delta P_T / ^\circ\text{C}$	-2.0	mW / °C
Isolation voltage (Note 1)		BV_S	2500 (AC, 1min., R.H. \leq 60%)	Vrms

Note: Using continuously under heavy loads (e.g. the application of high temperature/current/voltage and the significant change in temperature, etc.) may cause this product to decrease in the reliability significantly even if the operating conditions (i.e. operating temperature/current/voltage, etc.) are within the absolute maximum ratings.

Please design the appropriate reliability upon reviewing the Toshiba Semiconductor Reliability Handbook ("Handling Precautions"/"Derating Concept and Methods") and individual reliability data (i.e. reliability test report and estimated failure rate, etc).

(Note 1) Device considered a two terminal device: Pins 1, 3 shorted together and pins 4, 6 shorted together.

Individual Electrical Characteristics (Ta = 25°C)

Characteristic		Symbol	Test Condition	Min.	Typ.	Max.	Unit
LED	Forward voltage	V_F	$I_F = 10 \text{ mA}$	1.0	1.15	1.3	V
	Reverse current	I_R	$V_R = 5 \text{ V}$	—	—	10	μA
	Capacitance	C_T	$V = 0, f = 1 \text{ MHz}$	—	30	—	pF
Detector	Collector-emitter breakdown voltage	$V_{(BR)CEO}$	$I_C = 0.1 \text{ mA}$	300	—	—	V
	Emitter-collector breakdown voltage	$V_{(BR)ECO}$	$I_E = 0.1 \text{ mA}$	0.3	—	—	V
	Collector dark current	I_{CEO}	$V_{CE} = 200 \text{ V}$	—	10	200	nA
			$V_{CE} = 200 \text{ V}, T_a = 85^\circ\text{C}$	—	—	20	μA
Capacitance collector to emitter	C_{CE}	$V = 0, f = 1 \text{ MHz}$	—	12	—	pF	

Coupled Electrical Characteristics (Ta = 25°C)

Characteristic	Symbol	Test Condition	Min.	Typ.	Max.	Unit
Current transfer ratio	I_C / I_F	$I_F = 1 \text{ mA}, V_{CE} = 1 \text{ V}$	1000	4000	—	%
Saturated CTR	$I_C / I_F (\text{sat})$	$I_F = 10 \text{ mA}, V_{CE} = 1 \text{ V}$	500	—	—	%
Collector-emitter saturation voltage	$V_{CE (\text{sat})}$	$I_C = 10 \text{ mA}, I_F = 1 \text{ mA}$	—	—	1.0	V
		$I_C = 100 \text{ mA}, I_F = 10 \text{ mA}$	0.3	—	1.2	

Isolation Characteristics (Ta = 25°C)

Characteristic	Symbol	Test Condition	Min.	Typ.	Max.	Unit
Capacitance (input to output)	C_S	$V_S = 0, f = 1 \text{ MHz}$	—	0.8	—	pF
Isolation resistance	R_S	$V_S = 500 \text{ V}, \text{R.H.} \leq 60\%$	5×10^{10}	10^{14}	—	Ω
Isolation voltage	BV_S	AC, 1 minute	2500	—	—	V_{rms}
		AC, 1 second, in oil	—	5000	—	
		DC, 1 minute, in oil	—	5000	—	V_{dc}

Switching Characteristics (Ta = 25°C)

Characteristic	Symbol	Test Condition	Min.	Typ.	Max.	Unit
Rise time	t_r	$V_{CC} = 10\text{ V}, I_C = 10\text{ mA}$ $R_L = 100\ \Omega$	—	40	—	μs
Fall time	t_f		—	15	—	
Turn-on time	t_{on}		—	50	—	
Turn-off time	t_{off}		—	15	—	
Turn-on time	t_{ON}	$R_L = 180\ \Omega$ $V_{CC} = 10\text{ V}, I_F = 16\text{ mA}$ (Fig.1)	—	5	—	μs
Storage time	t_s		—	40	—	
Turn-off time	t_{OFF}		—	80	—	

Recommended Operating Conditions

Characteristic	Symbol	Min.	Typ.	Max.	Unit
Supply voltage	V_{CC}	—	—	200	V
Forward current	I_F	—	16	25	mA
Collector current	I_C	—	—	120	mA
Operating temperature	T_{opr}	-25	—	85	°C

Note: Recommended operating conditions are given as a design guideline to obtain expected performance of the device. Additionally, each item is an independent guideline respectively. In developing designs using this product, please confirm specified characteristics shown in this document.

Fig. 1 Switching time test circuit

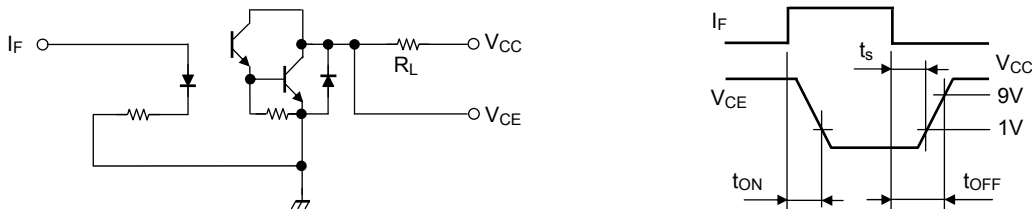

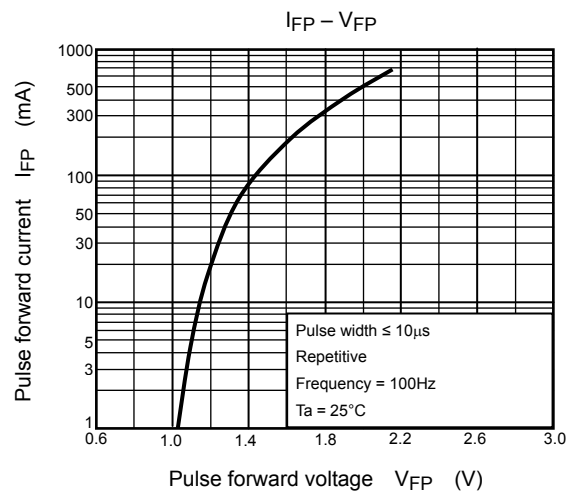
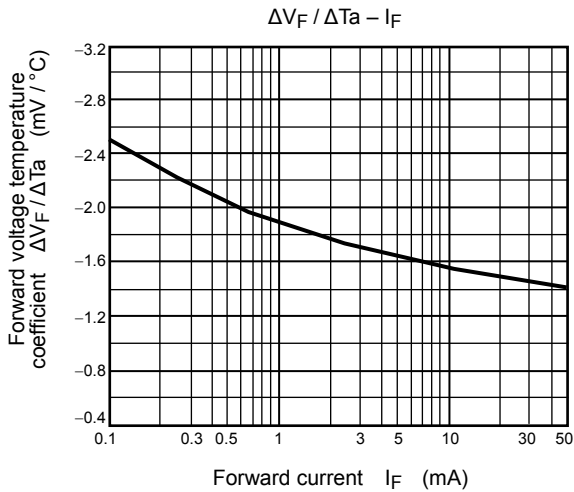
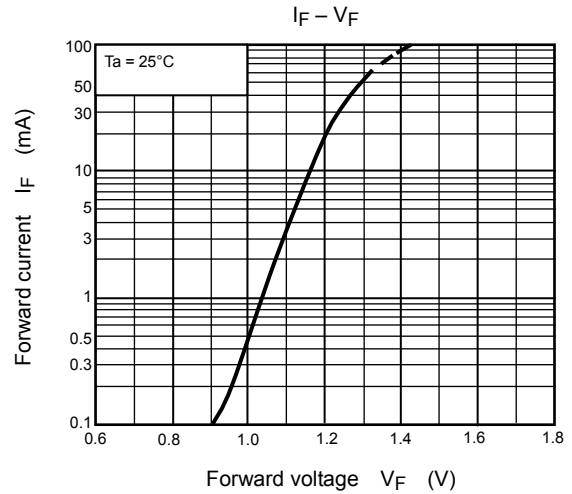
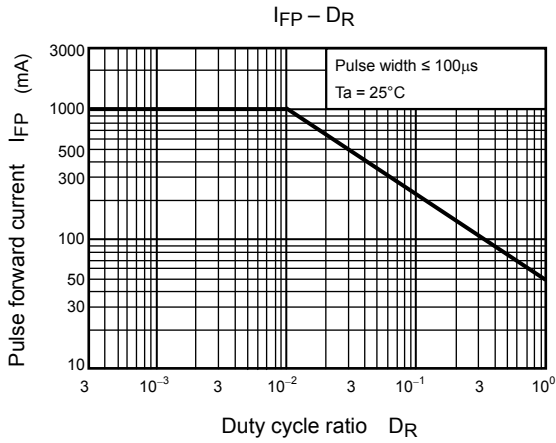
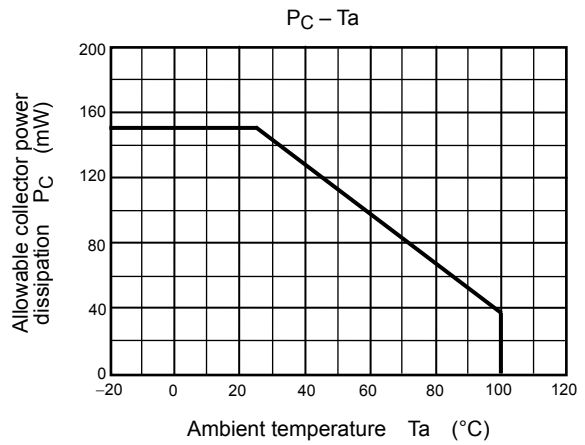
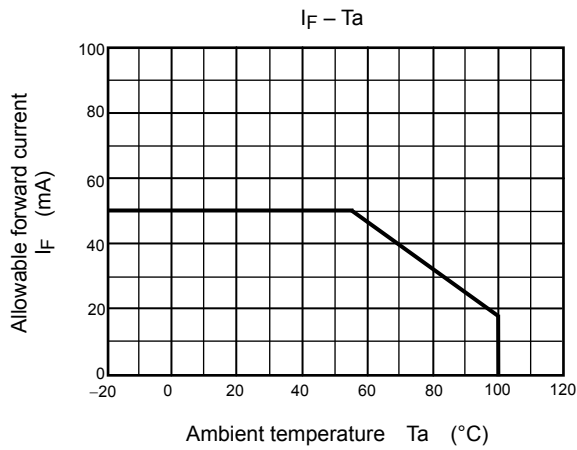

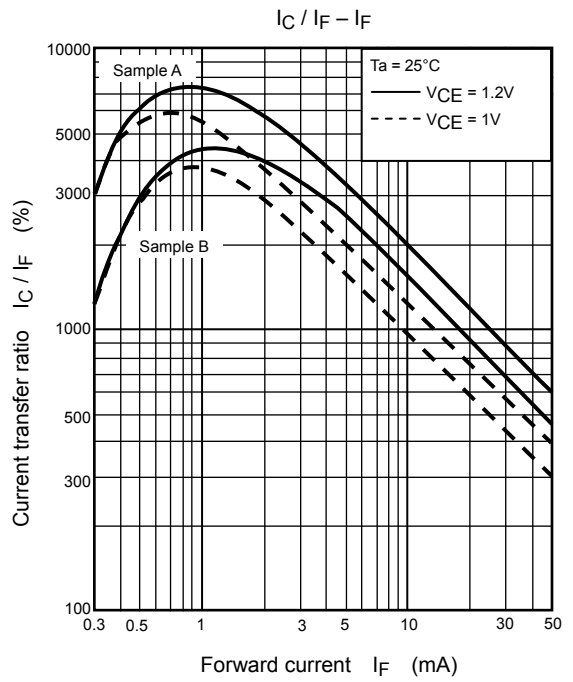
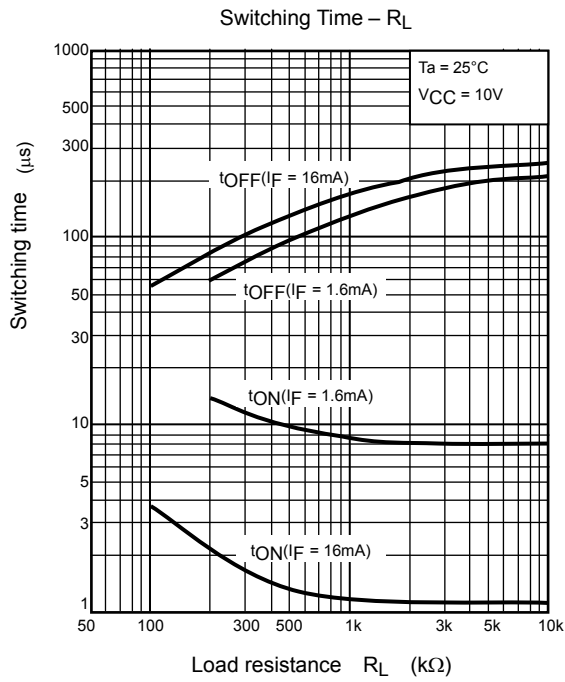
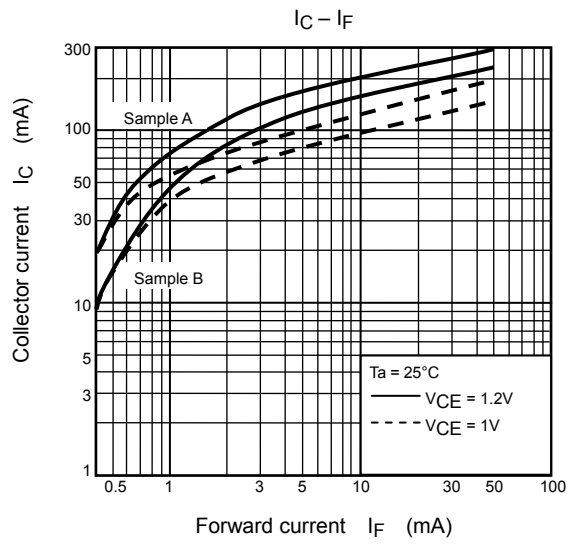
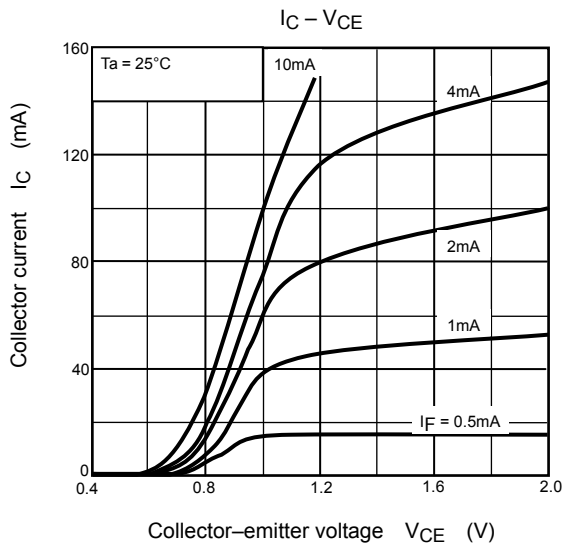

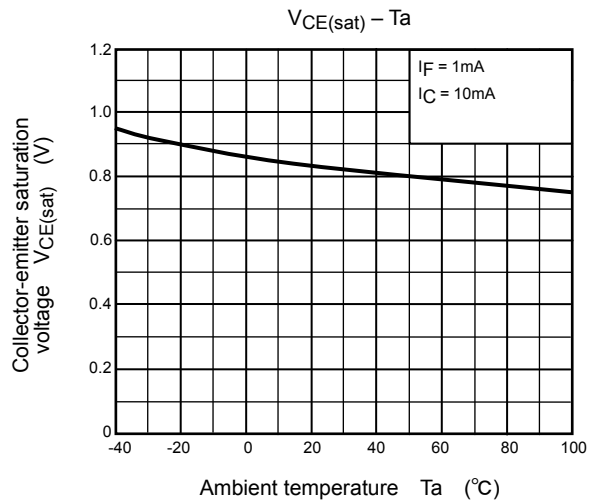
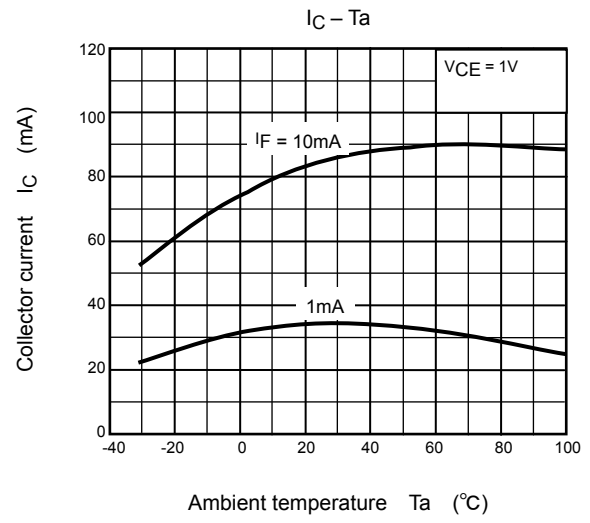
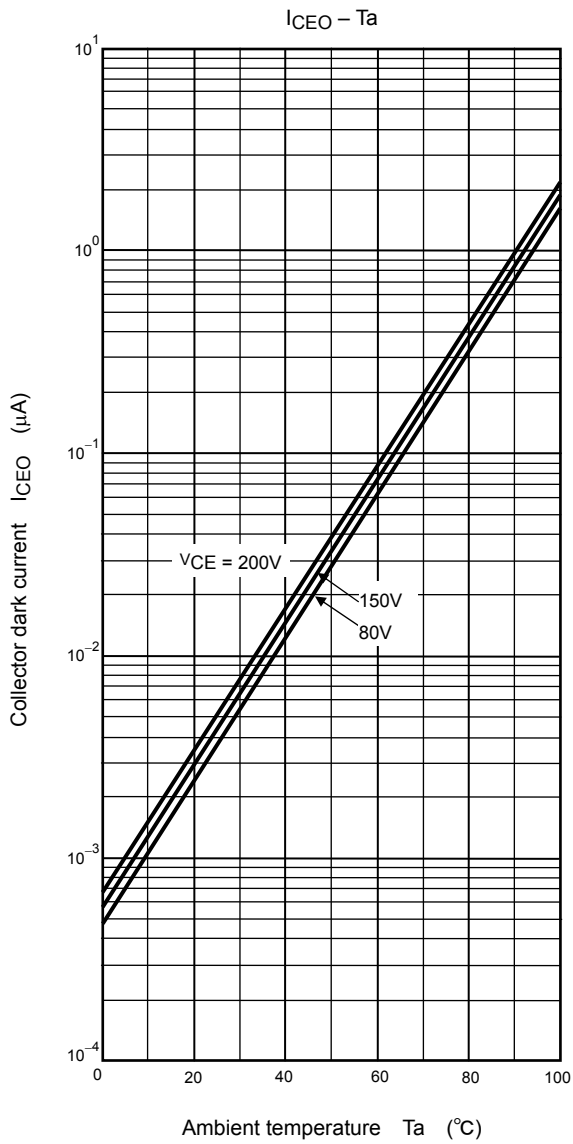

RESTRICTIONS ON PRODUCT USE

20070701-EN

- The information contained herein is subject to change without notice.
- TOSHIBA is continually working to improve the quality and reliability of its products. Nevertheless, semiconductor devices in general can malfunction or fail due to their inherent electrical sensitivity and vulnerability to physical stress. It is the responsibility of the buyer, when utilizing TOSHIBA products, to comply with the standards of safety in making a safe design for the entire system, and to avoid situations in which a malfunction or failure of such TOSHIBA products could cause loss of human life, bodily injury or damage to property.
In developing your designs, please ensure that TOSHIBA products are used within specified operating ranges as set forth in the most recent TOSHIBA products specifications. Also, please keep in mind the precautions and conditions set forth in the "Handling Guide for Semiconductor Devices," or "TOSHIBA Semiconductor Reliability Handbook" etc.
- The TOSHIBA products listed in this document are intended for usage in general electronics applications (computer, personal equipment, office equipment, measuring equipment, industrial robotics, domestic appliances, etc.). These TOSHIBA products are neither intended nor warranted for usage in equipment that requires extraordinarily high quality and/or reliability or a malfunction or failure of which may cause loss of human life or bodily injury ("Unintended Usage"). Unintended Usage include atomic energy control instruments, airplane or spaceship instruments, transportation instruments, traffic signal instruments, combustion control instruments, medical instruments, all types of safety devices, etc.. Unintended Usage of TOSHIBA products listed in this document shall be made at the customer's own risk.
- The products described in this document shall not be used or embedded to any downstream products of which manufacture, use and/or sale are prohibited under any applicable laws and regulations.
- The information contained herein is presented only as a guide for the applications of our products. No responsibility is assumed by TOSHIBA for any infringements of patents or other rights of the third parties which may result from its use. No license is granted by implication or otherwise under any patents or other rights of TOSHIBA or the third parties.
- GaAs(Gallium Arsenide) is used in this product. The dust or vapor is harmful to the human body. Do not break, cut, crush or dissolve chemically.
- Please contact your sales representative for product-by-product details in this document regarding RoHS compatibility. Please use these products in this document in compliance with all applicable laws and regulations that regulate the inclusion or use of controlled substances. Toshiba assumes no liability for damage or losses occurring as a result of noncompliance with applicable laws and regulations.

X-ON Electronics

Largest Supplier of Electrical and Electronic Components

Click to view similar products for [Transistor Output Optocouplers](#) category:

Click to view products by [Toshiba](#) manufacturer:

Other Similar products are found below :

[LTV-814S-TA](#) [LTV-824HS](#) [66095-001](#) [6N136-X017T](#) [MCT6-X007](#) [MOC8101-X017T](#) [PS2561A-1-W-A](#) [PS2561B-1-L-A](#) [PS2561L-1-V-A](#)
[MRF658](#) [IL755-1X007](#) [ILD2-X006](#) [ILD74-X001](#) [ILQ615-2X017](#) [ILQ615-3X016](#) [LDA102S](#) [LDA110S](#) [PS2561-1-V-W-A](#) [PS2561AL-1-V-](#)
[A](#) [PS2561L1-1-L-A](#) [PS2701A-1-F3-P-A](#) [PS2801-1-F3-P-A](#) [PS2911-1-L-AX](#) [CNY17-2X017](#) [CNY17-4X001](#) [CNY17-4X017](#) [CNY17F-](#)
[1X007](#) [CNY17F-2X017](#) [CNY17F-4X001](#) [CNY17G-1](#) [LTV-214](#) [LTV-702VB](#) [LTV-733S](#) [LTV-816S-TA](#) [LTV-825S](#) [TCET1113](#) [TCET2100](#)
[4N25-X007T](#) [IL215AT](#) [ILD615-1X007](#) [ILQ2-X007](#) [VOS615A-2T](#) [WPPC-A11066AA](#) [WPPC-A11066AD](#) [WPPC-A11084ASS](#) [WPPC-](#)
[A21068AA](#) [WPPC-D11066AA](#) [WPPC-D21068ED](#) [WPPC-D410616EA](#) [WPPC-D410616ED](#)