

TOSHIBA

Leading Innovation >>>

Semiconductor Catalog May 2015

Photocouplers and Photorelays

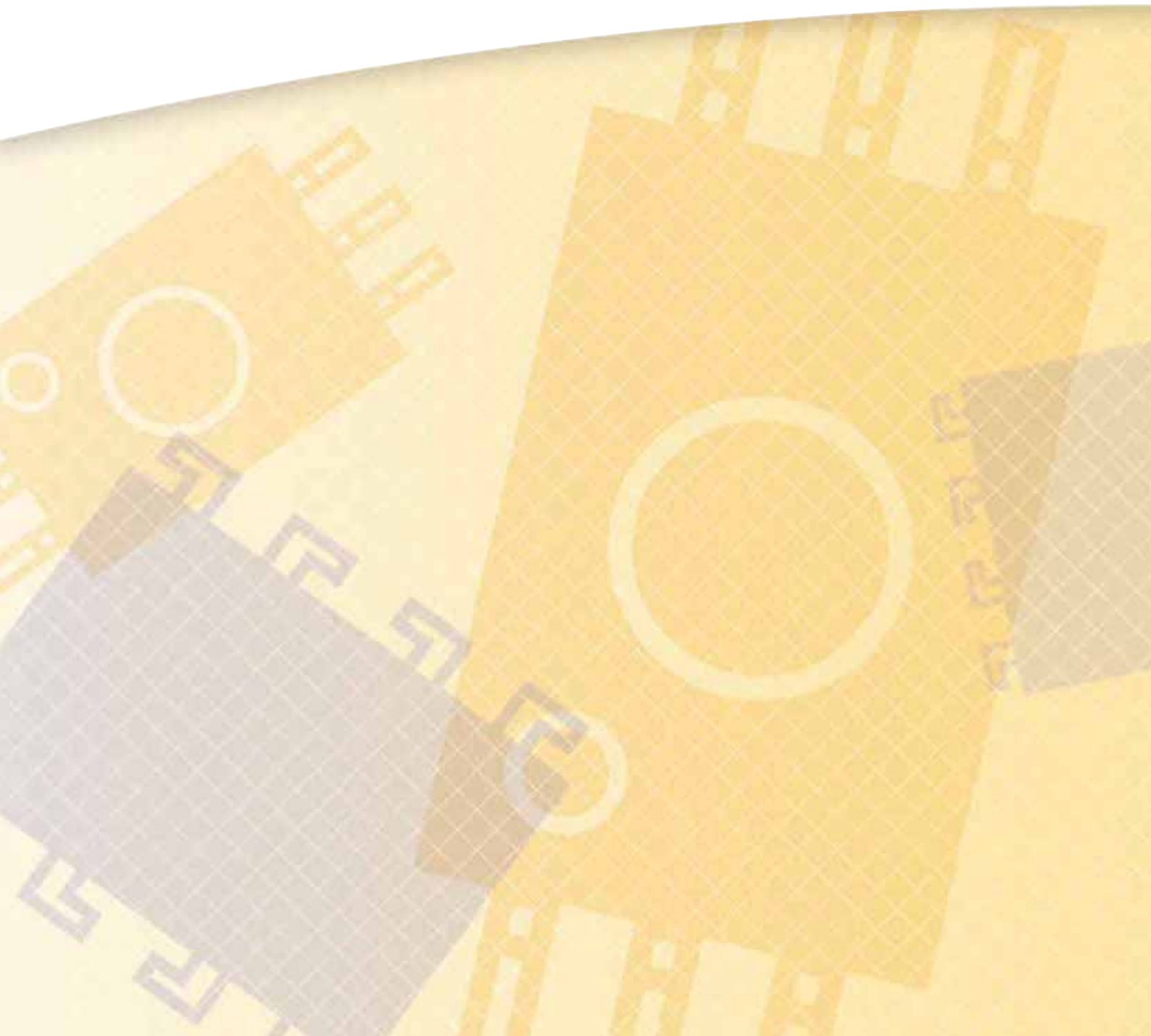

SEMICONDUCTOR & STORAGE PRODUCTS

<http://toshiba.semicon-storage.com/>

Photocouplers are widely used in various electronic devices to isolate high-speed signals from noise-sensitive circuits. Toshiba's photocouplers consist of a high-intensity infrared light-emitting diode (LED) optically coupled to a photodetector fabricated using the latest process. The LED-photodetector couple is encapsulated in an electrically insulating resin with high transparency. Features of Toshiba's photocouplers include certification to many international safety standards, high isolation and low power consumption. They are suitable for applications requiring a high level of safety.

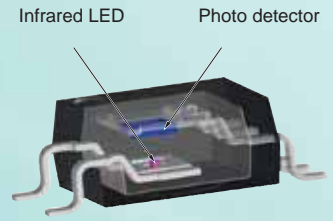

Photocoupler Package

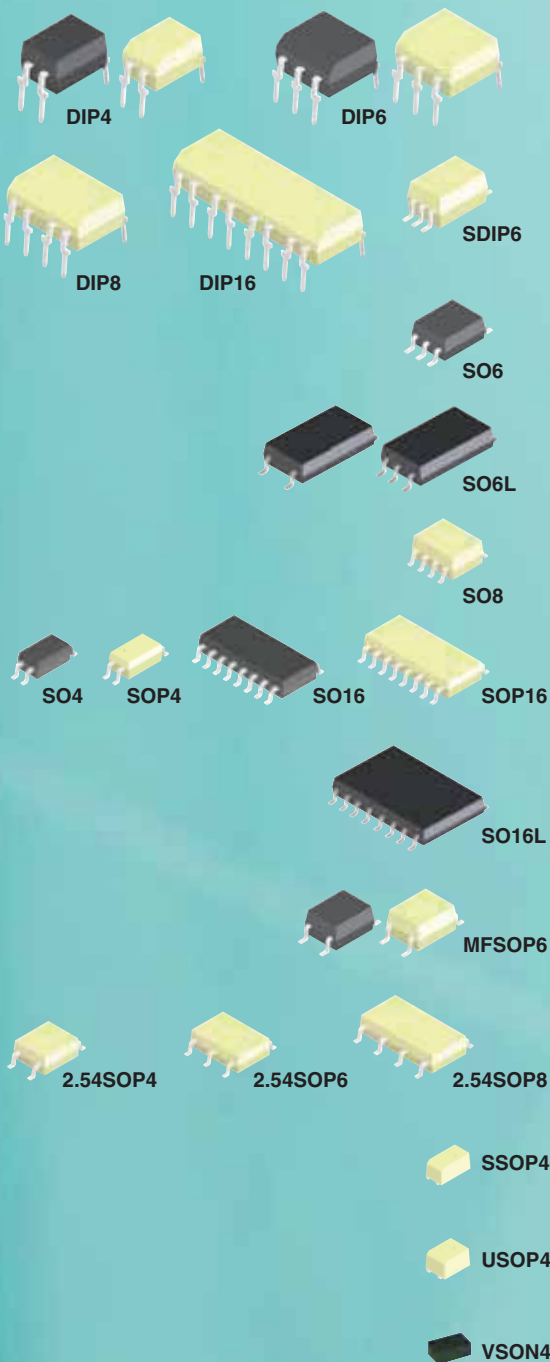

DIP4

DIP6

- General-purpose packages
- Lead-forming options for surface mounting

DIP8

DIP16

SDIP6

- ≥ 7 mm clearance / creepage; ≥ 0.4 mm isolation thickness
- 6 pin thin SMD package (1.27 mm lead pitch)

SO6

- ≥ 5 mm clearance/creepage; ≥ 0.4 mm isolation thickness
- 5 pin thin SMD package (1.27 mm lead pitch)

SO6L

- ≥ 8 mm clearance/creepage; ≥ 0.4 mm isolation thickness

SO8

- 8 pin SMD package (1.27 mm lead pitch)

SOP4

SO4

- 4 pin SMD package (1.27 mm lead pitch)
- 16 pin SMD package (1.27 mm lead pitch)

SOP16

SO16

SO16L

- ≥ 8 mm clearance/creepage; ≥ 0.4 mm isolation thickness
- 16 pin SMD package (1.27 mm lead pitch)

MFSOP6

- SMD package (1.27 mm lead pitch)

2.54SOP4

2.54SOP6

- SMD package (2.54 mm lead pitch)

2.54SOP8

SSOP4

- Ultra-small SMD package (1.27 mm lead pitch)

USOP4

- Ultra-small SMD package (1.27 mm lead pitch)

VSON4

- SMD package (Very Small Outline Non-leaded)

Product Lineup

Both photocouplers and photorelays consist of a light-emitting element and a light-receiving element in the same package. Their input and output signals are optically coupled with each other to provide electrical isolation. Photocouplers and photorelays are available with many output types to meet various interface needs.

Isolation Amplifier

Page 6

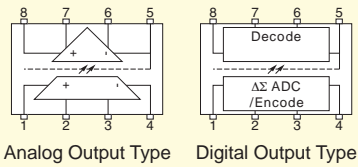

IC Output

Page 7

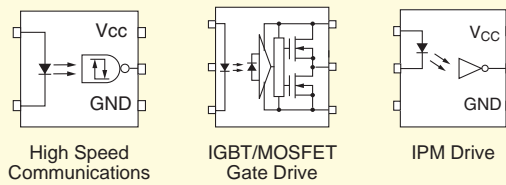

Transistor Output

Page 21

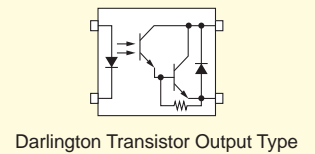
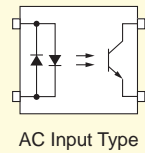
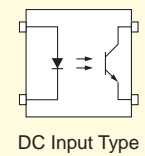

Triac Output

Page 25

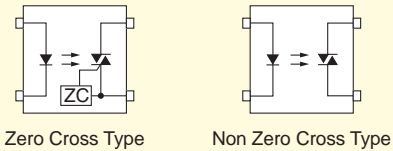

Photocoupler Product Lineup

Thyristor Output

Page 29

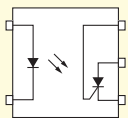

Photovoltaic Output

Page 30

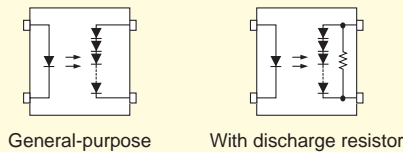

Photorelays

Page 31

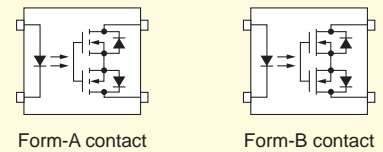

New Product Digest

Page 4

Device Degradation

Page 58

Package

Page 44

Safety Standard Approvals

Page 64

Packing

Page 52

Part Number Index

Page 66

Board Assembly

Page 56

Toshiba Launches Low Power Consumption 15 Mbps High-speed Photocoupler with Creepage and Clearance Distance of 8 mm: TLP2761

The new photocoupler has a low height of 2.3 mm (max), an approximately 45 % reduction from conventional SDIP package products, and contribute to the development of thinner and smaller sets. Despite the low height, the new product guarantees a creepage and clearance distance of 8 mm (min), and isolation voltage of 5000 Vrms (min), making it suitable for applications requiring higher isolation specs.

"TLP2761" incorporate Toshiba's original high output infrared LEDs in the input side and reduces the threshold input current by approximately 54 % compared with Toshiba conventional products^[1]. In the output side, it contains a photo detector IC die fabricated with a Bi-CMOS process, and reduces the supply current by approximately 66 % compared with conventional products^[1]. Furthermore, it can contribute to lowering the operation voltage of sets with guaranteed supply voltage of 2.7 V to 5.5 V, at temperatures up to 125 degrees Celsius, the industry's highest class^[2] of operation.

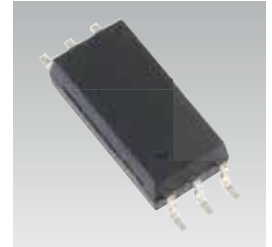

Toshiba Launches Low-height Package Low-input Current Drive Transistor Output Photocoupler: TLP383

The new product incorporate Toshiba's original high output infrared LEDs and guarantee the same CTR (Current Transfer Ratio) at 0.5 mA input current and at 5.0 mA input current.

The new photocoupler has a low height of 2.3 mm (max), an approximately 45 % reduction from Toshiba conventional DIP4 package products. At the same time, the new product has an isolation specification equivalent to DIP4 wide lead type package products and guarantees a creepage and clearance distance of 8 mm (min), and isolation voltage of 5000 Vrms (min). With its low height, the "TLP383" can be used in situations where there are strict height restrictions, such as on motherboards, and contribute to the development of smaller sets. It can be used for applications including inverter interfaces and general-purpose power supplies.

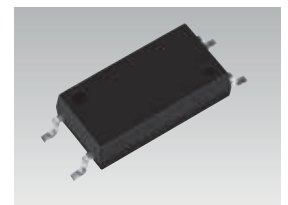

Ultra-small and thin VSON photorelay series: TLP3417, TLP3420, TLP3440, TLP3475

The TLP3440 and TLP3475 are suited to high-frequency applications. The TLP3475 provides improved on-state conduction characteristics, thus eliminating or reducing potential problems in high-frequency signal transmission. The TLP3440 has lower off-state leakage due to a high-frequency signal. While the TLP3417 and TLP3420 provide electrical characteristics equivalent to their predecessors in the USOP4 package, they have a 50% less mounting area. The TLP3417 and TLP3420 are suited to high-voltage applications such as semiconductor test equipment in which a device under test must tolerate high voltage. The TLP3417 has a V_{OFF} of 80 V while the TLP3420 has a V_{OFF} of 100 V.

Features

- Ultra-small VSON4 package (50% footprint area reduction compared to the USOP4 package)
- Chip-on-chip structure*
- Photorelays for high-frequency applications: TLP3440, TLP3475
- Photorelays for high-voltage applications: TLP3417, TLP3420

*: Chip-on-chip structure: An LED chip is stacked on top of a photodetector chip, with an insulation material in between.

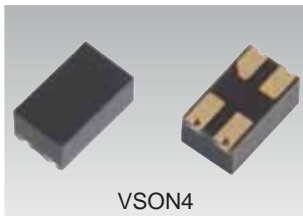

Pin configuration

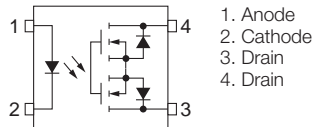

1. Anode
2. Cathode
3. Drain
4. Drain

Applications

- Semiconductor test equipment
- Measuring instruments
- Medical devices
- Probe cards

Rail-to-rail-output gate drive photocouplers: TLP5751, TLP5752, TLP5754

The TLP5751, TLP5752 and TLP5754 provide rail-to-rail outputs for full voltage swing almost equivalent to the supply voltage range, reducing losses in the photocoupler and the power device it drives. These photocouplers differ in the peak output current (1 A / 2.5 A / 4 A); so you can select one that best suits your need. Since these photocouplers incorporate an LED with outstanding lifetime characteristics, they are suitable for applications that are exposed to harsh heat conditions, including industry equipment, photovoltaic power generation systems and uninterruptible power supplies (UPS).

Features

- Housed in a 2.3-mm-thick SO6L package, which is approximately 54% thinner than SDIP
- Lower loss due to rail-to-rail output
- Available with different peak output currents (1 A / 2.5 A / 4 A)
- LED with excellent lifetime characteristics
- High operating temperature: $T_{opr} = 110^{\circ}\text{C}$ (max)



Pin configuration

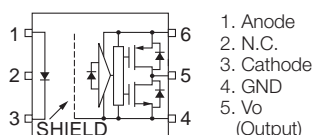

1. Anode
2. N.C.
3. Cathode
4. GND
5. V_o (Output)
6. V_{cc}



Applications

- IGBT and MOSFET gate drivers
- General-purpose inverters
- Air-conditioner inverters
- Servo amplifiers

Product Lineup

Isolation Amplifier

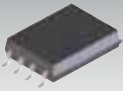
Selection Table

		
Output Configuration	SO8L	DIP8
Analog Output Type	TLP7820 **	TLP7920 **
Digital Output type	TLP7830 **	TLP7930 **

** : Under development

Selection Guide

Analog Output Type

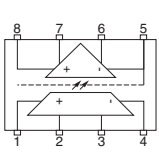
Part Number	Pin Configuration	Features	Gain Error Rank (Ta=25°C) (%) max	Non Linearity INL ₂₀₀ (Ta=25°C) (%) typ.	Input Offset Voltage (mV) typ.	Supply Current		BVs @1min. (V _{rms})	Safety Standards ⁽¹⁾				
						Input I _{DD1} (mA) max	Output I _{DD2} (mA) max		UL	c-UL	VDE	BSI	CQC
TLP7820 **		SO8L • Gain = 8.2 (typ.) • Topr = 105°C (max)	±0.5 ±1.0 ±3.0	0.02	0.9	12	10	5000	△	△	△		△
TLP7920 **		DIP8 • Gain = 8.2 (typ.) • Topr = 105°C (max)							△	△	△		△

** : Under development

Digital Output Type

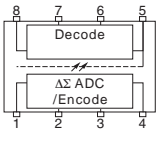
Part Number	Pin Configuration	Features	SNDR (Ta=25°C) (dB) typ.	SNR (Ta=25°C) (dB) typ.	Output Clock Frequency (MHz) typ.	Supply Current		BVs @1min. (V _{rms})	Safety Standards ⁽¹⁾				
						Input I _{DD1} (mA) max	Output I _{DD2} (mA) max		UL	c-UL	VDE	BSI	CQC
TLP7830 **		SO8L • 1bit digital & CLK output • Topr = 105°C (max)	75	80	10	15	8.0	5000	△	△	△		△
TLP7930 **		DIP8 • 1bit digital & CLK output • Topr = 105°C (max)							△	△	△		△







































Note (1): Please refer to page 43.















** : Under development



SNDR: Signal to Noise and Distortion Ratio
SNR: Signal to Noise Ratio

IC Output <High Speed Communications>

Selection Table

									
Data Rate (Typ.)	Output	5 pin MFSOP6	4 pin SO6	5 pin SO6	SO8		SO6L	SDIP6	
					1ch	2ch		(F type)	
20 kbit/s	Open-collector		TLP2301 						
100 to 300 kbit/s	Open-collector			TLP2303 	TLP2403		TLP2703 * 		
1 Mbit/s	Open-collector			TLP109 TLP2309	TLP2409 				
	IPM drive			TLP104  TLP109 (IGM)	TLP2404 		TLP2704 **	TLP714 TLP719	TLP714F TLP719F
5 Mbit/s	Totem-pole	TLP2095 TLP2098		TLP2310 *			TLP2110 ** TLP2105 TLP2108	TLP2710 *	
	AC input			TLP2395 * TLP2398 *					
	IPM drive			TLP2355  TLP2358 	TLP2405 TLP2408			TLP715 TLP718	TLP715F TLP718F
10 Mbit/s	Open-collector			TLP2362 					
	Totem-pole			TLP2391 * 					
	IPM drive			TLP2345 * TLP2348 *			TLP2745 ** TLP2748 **		
15 Mbit/s	Open-collector						TLP2118E	TLP708 	TLP708F 
	Totem-pole			TLP2361 * 			TLP2116 TLP2161 *  TLP2166A	TLP2761 * 	TLP716 TLP716F
20 Mbit/s	Open-collector			TLP118  TLP2368 	TLP2418 TLP2468 		TLP2168 	TLP2768A * 	TLP2768F  TLP2768F 
	Totem-pole	TLP2066 		TLP116A TLP2366 	TLP2466 		TLP2160 		TLP2766  TLP2766F 
40 Mbit/s	Totem-pole			TLP2367 ** 	TLP2167 ** 			TLP2767 ** 	TLP2767F ** 
50 Mbit/s	Totem-pole	TLP117							

							
Data Rate (Typ.)	Output	DIP6	DIP8				JEDEC Type
			1ch	(F type)	2ch	(F type)	
100 to 300 kbit/s	Open-collector		TLP553				6N138 6N139
1 Mbit/s	Open-collector	TLP512	TLP550 TLP551 TLP559 TLP651 TLP750 TLP751 TLP759	TLP750F TLP751F TLP759F	TLP2530 TLP2531		6N135 6N136
	IPM drive		TLP559 (IGM) TLP754 TLP759 (IGM)	TLP754F TLP759F (IGM)			
2.5 Mbit/s	3-state		TLP2200 				
5 Mbit/s	Totem-pole		TLP555  TLP558 				
	IPM drive		TLP2955  TLP2958 	TLP2955F  TLP2958F 			
10 Mbit/s	Open-collector	TLP513	TLP552 TLP554 TLP2601 TLP2962  TLPN137	TLP2962F 	TLP2630 TLP2631 TLP2662 	TLP2662F 	6N137

 Photocouplers with a maximum operating temperature (Topr.) of 125°C
 Photocouplers with low input current.
 *: New product **: Under development

Selection Guide

Data Rate: 20 k bps (Typ.)

Part Number	Pin Configuration	Features	Propagation Delay Time (max)		CTR		BVs @1min. (Vrms)	Safety Standards ⁽¹⁾				
			t _{pHL} (μs)	t _{pLH} (μs)	min (%)	@ I _F (mA)		UL	c-UL	VDE	BSI	CQC
TLP2301		4 pin SO6 • Reinforced insulation • Low input drive current • Data Rate (Typ. @NRZ) 20 k bps	30	30	50	1	3750	○	○	□		△

Data Rate: 100 k / 300 k bps (Typ.)

Part Number	Pin Configuration	Features	Propagation Delay Time (max)		CTR		BVs @1min. (Vrms)	Safety Standards ⁽¹⁾				
			t _{pHL} (μs)	t _{pLH} (μs)	min (%)	@ I _F (mA)		UL	c-UL	VDE	BSI	CQC
TLP2303		5 pin SO6 • Reinforced insulation • Low input drive current • Data Rate (Typ. @NRZ) 100 k bps	15	50	900	0.5	3750	○	○	□		○
TLP2703 *		SO6L • Reinforced insulation • Low input drive current • Data Rate (Typ. @NRZ) 100 k bps					5000	△	△	△		△
TLP553		DIP8 • Low input drive current • Data Rate (Typ. @NRZ) 300 k bps	25	60	400		2500	○				
TLP2403		SO8 • SO8 version of the TLP553 • Data Rate (Typ. @NRZ) 300 k bps					3750	○	○	○		

*: New product

Data Rate: 1 M bps (Typ.)

Part Number	Pin Configuration	Features	Propagation Delay Time (max)		CTR		BVs @1min. (Vrms)	Safety Standards ⁽¹⁾				
			t _{pHL} (μs)	t _{pLH} (μs)	min (%)	@ I _F (mA)		UL	c-UL	VDE	BSI	CQC
TLP109		5 pin SO6 • Reinforced insulation • Data Rate (Typ. @NRZ) 1 M bps	0.8	0.8	20	16	3750	○	○	□		○
TLP512		DIP6 • DIP6 package version of the TLP550 • Data Rate (Typ. @NRZ) 1 M bps					2500	○				
TLP550		DIP8 • High CMR • Data Rate (Typ. @NRZ) 1 M bps	0.8	2	10 (19% min for rank O)		2500	○	○			
TLP551		DIP8 • Internal base connection • Data Rate (Typ. @NRZ) 1 M bps					2500	○	○			

Note (1): Please refer to page 43.

Data Rate: 1 M bps (Typ.)

Part Number	Pin Configuration	Features	Propagation Delay Time (max)		CTR		BV _s @1min. (Vrms)	Safety Standards ⁽¹⁾					
			t _{pHL} (μs)	t _{pLH} (μs)	min (%)	@ I _F (mA)		UL	c-UL	VDE	BSI	CQC	
TLP559		DIP8 •High CMR version of the TLP550 •Data Rate (Typ. @NRZ) 1 M bps	0.8	0.8	20	16	2500	○	○				
TLP651		DIP8 •High isolation voltage •Internal base connection •Data Rate (Typ. @NRZ) 1 M bps	0.8	2.0	10 (19% min for rank O)		5000	○	○				
TLP719 TLP719F		SDIP6 •Direct drive of an IPM •Data Rate (Typ. @NRZ) 1 M bps	0.8	0.8	20		5000	○	○	○			
TLP750 TLP750F		DIP8 •High isolation voltage •SEMKO-approved •Data Rate (Typ. @NRZ) 1 M bps	0.8	2	10 (19% min for rank O)		5000	○	○	○	○		
TLP751 TLP751F		DIP8 •Internal base connection •SEMKO-approved •Data Rate (Typ. @NRZ) 1 M bps	0.2 (Typ.)	1.0 (Typ.)	10		5000	○	○	○	○		
TLP759 TLP759F		DIP8 •IEC60950 design standard version of the TLP559 •SEMKO-approved •Data Rate (Typ. @NRZ) 1 M bps	0.8	0.8	20		5000	○	○	○	○		
TLP2309		5 pin SO6 •Reinforced insulation •3.3-V/5.0-V power supplies •Data Rate (Typ. @NRZ) 1 M bps	1.0	1.0	15		10	3750	○	○	□		○
TLP2409		SO8 •T _{opr} = 125°C (max) •SO8 version of the TLP109 •Data Rate (Typ. @NRZ) 1 M bps	0.8	0.8	20		10	3750	○	○	○		
TLP2530		DIP8 •Dual channel version of the 6N135 and the TLP550 •Data Rate (Typ. @NRZ) 1 M bps	1.5	1.5	7		16	2500	○	○			
TLP2531		DIP8 •Dual channel version of the 6N135 and the TLP550 •Data Rate (Typ. @NRZ) 1 M bps	0.8	0.8	19		16	2500	○	○			

Note (1): Please refer to page 43.

Data Rate: 2.5 M bps (Typ.)

Part Number	Pin Configuration	Features	Propagation Delay Time (max)		Output Form	BVs @1min. (Vrms)	Safety Standards ⁽¹⁾						
			t _{pHL} (μs)	t _{pLH} (μs)			@ I _F (mA)	UL	c-UL	VDE	BSI	CQC	
TLP2200		DIP8 • Low input current • Data Rate (Typ. @NRZ) 2.5 M bps	0.4	0.4	3-state output (Buffer logic)	I _{FLH} = 1.6 (max)	2500	○	○				

Data Rate: 5 M bps (Typ.)

Part Number	Pin Configuration	Features	Propagation Delay Time (max)		Output Form	BVs @1min. (Vrms)	Safety Standards ⁽¹⁾						
			t _{pHL} (μs)	t _{pLH} (μs)			@ I _F (mA)	UL	c-UL	VDE	BSI	CQC	
TLP555		DIP8 • Low input current • Vcc = 4.5 to 20 V • With enable pin • Data Rate (Typ. @NRZ) 5 M bps	0.4	0.4	3-state output (Buffer logic)	I _{FLH} = 1.6 (max)	2500	○	○				
TLP558					3-state output (Inverter logic)	I _{FHL} = 1.6 (max)		○	○				
TLP715 TLP715F		SDIP6 • Direct drive of an IPM • Data Rate (Typ. @NRZ) 5 M bps	0.25	0.25	Totem pole output (Buffer logic)	I _{FLH} = 3 (max)	5000	○	○	○			
TLP718 TLP718F					Totem pole output (Inverter logic)	I _{FHL} = 3 (max)		○	○	○			
TLP2095		5 pin MFSOP6 • AC input • Vcc = 3.0 to 20 V • Data Rate (Typ. @NRZ) 5 M bps	0.25	0.25	Totem pole output (Buffer logic)	I _{FLH} = ±3.0	3750	○	○	○			
TLP2098					Totem pole output (Inverter logic)	I _{FHL} = ±3.0		○	○	○			
TLP2105		SO8 • Dual channel • Data Rate (Typ. @NRZ) 5 M bps	0.2	0.2	Totem pole output (Buffer logic)	I _{FLH} = 1.6 (max)	2500	○	○	○			
TLP2108					Totem pole output (Inverter logic)	I _{FHL} = 1.6 (max)		○	○	○			
TLP2110		SO8 • Dual channel version of the TLP2310 • Data Rate (Typ. @NRZ) 5 M bps	0.2	0.2	Totem pole output (Buffer logic)	I _{FLH} = 1.0 (max)		△	△	△		△	
TLP2310		5 pin SO6 • Reinforced insulation • Ultra low consumption • Data Rate (Typ. @NRZ) 5 M bps	0.25	0.25	Totem pole output (Buffer logic)	I _{FLH} = 1.0 (max)	3750	○	○	□		○	
TLP2355					5 pin SO6 • Reinforced insulation • Direct drive of an IPM • Data Rate (Typ. @NRZ) 5 M bps	Totem pole output (Buffer logic)		I _{FLH} = 1.6 (max)	○	○	□		○

Note (1): Please refer to page 43.

*: New product **: Under development

Data Rate: 5 M bps (Typ.)

Part Number	Pin Configuration	Features	Propagation Delay Time (max)		Output Form	BVs @1min. (Vrms)	Safety Standards ⁽¹⁾						
			t _{pHL} (μs)	t _{pLH} (μs)			@ I _F (mA)	UL	c-UL	VDE	BSI	CQC	
TLP2358		5 pin SO6 • Reinforced insulation • Direct drive of an IPM • Data Rate (Typ. @NRZ) 5 M bps	0.25	0.25	Totempole output (Inverter logic)	3750	3750	○	○	□		○	
TLP2395 *		5 pin SO6 • AC input version of the TLP2355 • Data Rate (Typ. @NRZ) 5 M bps			Totempole output (Buffer logic)								I _{FLH} = ±2.3 (max)
TLP2398 *		5 pin SO6 • AC input version of the TLP2355 • Data Rate (Typ. @NRZ) 5 M bps			Totempole output (Inverter logic)								I _{FLH} = ±2.3 (max)
TLP2405		SO8 • Low input current • Direct drive of an IPM • Data Rate (Typ. @NRZ) 5 M bps			Totempole output (Buffer logic)								I _{FLH} = 1.6 (max)
TLP2408		SO8 • Low input current • Direct drive of an IPM • Data Rate (Typ. @NRZ) 5 M bps			Totempole output (Inverter logic)								I _{FLH} = 1.6 (max)
TLP2710 *		SO6L • SO6L version of the TLP2310 • Data Rate (Typ. @NRZ) 5 M bps			Totempole output (Buffer logic)								I _{FLH} = 1.0 (max)
TLP2955 TLP2955F		DIP8 • T _{opr} = 125°C (max) • Low input current • V _{cc} = 3.0~20-V • Direct drive of an IPM • Data Rate (Typ. @NRZ) 5 M bps			5000								Totempole output (Buffer logic)
TLP2958 TLP2958F		DIP8 • T _{opr} = 125°C (max) • Low input current • V _{cc} = 3.0~20-V • Direct drive of an IPM • Data Rate (Typ. @NRZ) 5 M bps	Totempole output (Inverter logic)	I _{FLH} = 1.6 (max)									

*: New product

Data Rate: 10 M bps (Typ.)

Part Number	Pin Configuration	Features	Propagation Delay Time (max)		Output Form	BVs @1min. (Vrms)	Safety Standards ⁽¹⁾						
			t _{pHL} (μs)	t _{pLH} (μs)			@ I _F (mA)	UL	c-UL	VDE	BSI	CQC	
TLP552		DIP8 • High-speed • Data Rate (Typ. @NRZ) 10 M bps	0.12	0.12	Open-collector output (Inverter logic)	2500	2500	○					
TLP554		DIP8 • High-speed • High CMR version of the TLP552 • Data Rate (Typ. @NRZ) 10 M bps											Totempole output (Inverter logic)
TLP2345 *		5 pin SO6 • Reinforced insulation • High-speed • Direct drive of an IPM • Data Rate (Typ. @NRZ) 10 M bps			Totempole output (Buffer logic)								I _{FLH} = 1.6 (max)

Note (1): Please refer to page 43.

*: New product

Data Rate: 10 M bps (Typ.)

Part Number	Pin Configuration	Features	Propagation Delay Time (max)		Output Form	BVs @1min. (Vrms)	Safety Standards ⁽¹⁾					
			t _{pHL} (μs)	t _{pLH} (μs)			@ I _F (mA)	UL	c-UL	VDE	BSI	CQC
TLP2348 *		5 pin SO6 • Reinforced insulation • High-speed • Direct drive of an IPM • Data Rate (Typ. @NRZ) 10 M bps	0.12	0.12	Totempole output (Inverter logic)	I _{FHL} = 1.6 (max)	3750	○	○	□		△
TLP2362		5 pin SO6 • Reinforced insulation • V _{cc} = 2.7-V/5.5-V • Topr (max) 125°C • Data Rate (Typ. @NRZ) 10 M bps	0.1	0.1	Open-collector output (Inverter logic)	I _{FHL} = 5.0 (max)		○	○	□		○
TLP2391 *		5 pin SO6 • Reinforced insulation • V _{cc} = 3.3-V/5-V • Topr (max) 125°C • Data Rate (Typ. @NRZ) 10 M bps			Totempole output (Inverter logic)	I _{FHL} = ±2.5 (max)		○	○	□		
TLP2601		DIP8 • High-speed • High CMR • Data Rate (Typ. @NRZ) 10 M bps	0.075	0.075	Open-collector output (Inverter logic)	I _{FHL} = 5.0 (max)	2500	○	○			
TLP2630		DIP8 • Dual channel version of the 6N137 and the TLP552 • Data Rate (Typ. @NRZ) 10 M bps						○	○			
TLP2631		DIP8 • CM _{H/L} ±1 kV/μs (min) • Dual channel version of the TLP554 • Data Rate (Typ. @NRZ) 10 M bps						○	○			
TLP2662 TLP2662F		DIP8 • V _{cc} = 3.3-V/5-V • Topr (max) 125°C • Dual channel version of the TLP2962 • Data Rate (Typ. @NRZ) 10 M bps						○	○	□		
TLP2745 *		SO6L • Reinforced insulation • High-speed • Direct drive of an IPM • SO6L version of the TLP2345 • Data Rate (Typ. @NRZ) 10 M bps	0.12	0.12	Totempole output (Buffer logic)	I _{FLH} = 1.6 (max)	5000	○	○	□		△
TLP2748 *		SO6L • Reinforced insulation • High-speed • Direct drive of an IPM • SO6L version of the TLP2348 • Data Rate (Typ. @NRZ) 10 M bps			Totempole output (Inverter logic)	I _{FHL} = 1.6 (max)		△	△	△		△
TLP2962 TLP2962F		DIP8 • V _{cc} = 3.3-V/5-V • Topr (max) 125°C • Data Rate (Typ. @NRZ) 10 M bps	0.075	0.075	Open-collector output (Inverter logic)	I _{FHL} = 5.0 (max)		○	○	□		

Note (1): Please refer to page 43.

*: New product

Data Rate: 10 M bps (Typ.)

Part Number	Pin Configuration	Features	Propagation Delay Time (max)		Output Form	BVs @1min. (Vrms)	Safety Standards ⁽¹⁾					
			t _{pHL} (μs)	t _{pLH} (μs)			@ I _F (mA)	UL	c-UL	VDE	BSI	CQC
TLPN137		DIP8 • High-speed • Data Rate (Typ. @NRZ) 10 M bps	0.1	0.1	Open-collector output (Inverter logic)	I _{FHL} = 5.0 (max)	5000	○	○	□	△	

Data Rate: 15 M bps (Typ.)

Part Number	Pin Configuration	Features	Propagation Delay Time (max)		Output Form	BVs @1min. (Vrms)	Safety Standards ⁽¹⁾						
			t _{pHL} (μs)	t _{pLH} (μs)			@ I _F (mA)	UL	c-UL	VDE	BSI	CQC	
TLP708 TLP708F		SDIP6 • Topr (max) 125°C • High-speed • SDIP version of the TLP118 • Data Rate (Typ. @NRZ) 15 M bps	0.075	0.075	Open-collector output (Inverter logic)	5000	○	○	○				
TLP716 TLP716F		SDIP6 • High-speed • SDIP version of the TLP116A • Data Rate (Typ. @NRZ) 15 M bps			Totempole output (Inverter logic)								I _{FHL} = 6.5 (max)
TLP2116		SO8 • Dual channel version equivalent of the TLP116A • Data Rate (Typ. @NRZ) 15 M bps			I _{FHL} = 5.0 (max)								
TLP2118E		SO8 • Dual channel version equivalent of the TLP118 • Data Rate (Typ. @NRZ) 15 M bps			Open-collector output (Inverter logic)								
TLP2161 *		SO8 • Vcc = 3.3-V/5-V power supplies • Topr (max) 125°C • Data Rate (Typ. @NRZ) 15 M bps	0.08	0.08	Totempole output (Inverter logic)	2500	○	○	○				
TLP2166A		SO8 • Vcc = 3.0-V/3.6-V • Dual channel version equivalent of the TLP2366 • Data Rate (Typ. @NRZ) 15 M bps	0.075	0.075	Totempole output (Inverter logic)		○	○	○				
TLP2361 *		5 pin SO6 • Reinforced insulation • Vcc = 2.7-V/5.5-V • Topr (max) 125°C • Data Rate (Typ. @NRZ) 15 M bps	0.08	0.08	Totempole output (Inverter logic)	3750	○	○	□		○		
TLP2761 *		SO6L • Reinforced insulation • Vcc = 2.7-V/5.5-V • Topr (max) 125°C • SO6L version of the TLP2361 • Data Rate (Typ. @NRZ) 15 M bps				5000	○	○	△		△		

Note (1): Please refer to page 43.

*: New product

Data Rate: 20 M bps (Typ.)

Part Number	Pin Configuration	Features	Propagation Delay Time (max)		Output Form	BVs @1min. (Vrms)	Safety Standards ⁽¹⁾					
			t _{pHL} (ns)	t _{pLH} (ns)			@ I _F (mA)	UL	c-UL	VDE	BSI	CQC
TLP116A		5 pin SO6 • Reinforced insulation • Data Rate (Typ. @NRZ) 20 M bps	60	60	Totempole output (Inverter logic)	3750						
TLP118		5 pin SO6 • Reinforced insulation • Topr (max) 125°C • Data Rate (Typ. @NRZ) 20 M bps			Open-collector output (Inverter logic)							I _{FHL} = 5.0 (max)
TLP2066		5 pin MFSOP6 • 3.3-V power supply • Data Rate (Typ. @NRZ) 20 M bps			Totempole output (Inverter logic)							I _{FHL} = 5.0 (max)
TLP2160		SO8 • Dual channel • 3.3-V/5-V power supplies • Topr (max) 125°C • Data Rate (Typ. @NRZ) 20 M bps	40	40	Totempole output (Inverter logic)	2500						
TLP2168		SO8 • 3.3-V/5-V power supplies • Topr (max) 125°C • Data Rate (Typ. @NRZ) 20 M bps	60	60	Open-collector output (Inverter logic)							I _{FHL} = 5.0 (max)
TLP2366		5 pin SO6 • Reinforced insulation • 3.3-V/5-V power supplies • Topr (max) 125°C • Data Rate (Typ. @NRZ) 20 M bps	40	40	Totempole output (Inverter logic)	3750						
TLP2368		5 pin SO6 • Reinforced insulation • Topr (max) 125°C • Data Rate (Typ. @NRZ) 20 M bps	60	60	Open-collector output (Inverter logic)							I _{FHL} = 5.0 (max)
TLP2418		SO8 • Topr (max) 125°C • SO8 version of the TLP118 • Data Rate (Typ. @NRZ) 20 M bps	75	75	Open-collector output (Inverter logic)							I _{FHL} = 5.0 (max)
TLP2466		SO8 • 3.3-V/5-V power supplies • Topr (max) 125°C • Data Rate (Typ. @NRZ) 20 M bps	40	40	Totempole output (Inverter logic)	5000						
TLP2468		SO8 • 3.3-V/5-V power supplies • Topr (max) 125°C • Data Rate (Typ. @NRZ) 20 M bps	60	60	Open-collector output (Inverter logic)							I _{FHL} = 5.0 (max)
TLP2766 TLP2766F		SDIP6 • 3.3-V/5-V power supplies • Topr (max) 125°C • Data Rate (Typ. @NRZ) 20 M bps	40	40	Totempole output (Inverter logic)	5000						
TLP2768 TLP2768F		SDIP6 • 3.3-V/5-V power supplies • Topr (max) 125°C • Data Rate (Typ. @NRZ) 20 M bps	60	60	Open-collector output (Inverter logic)							I _{FHL} = 5.0 (max)

Note (1): Please refer to page 43.

Data Rate: 20 M bps (Typ.)

Part Number	Pin Configuration	Features	Propagation Delay Time (max)		Output Form	@ I _F (mA)	BVs @1min. (Vrms)	Safety Standards ⁽¹⁾					
			t _{pHL} (ns)	t _{pLH} (ns)				UL	c-UL	VDE	BSI	CQC	
TLP2768A *		SO6L • Reinforced insulation • Topr (max) 125°C • SO6L version of the TLP2368 • Data Rate (Typ. @NRZ) 20 M bps	60	60	Open-collector output (Inverter logic)	I _{FHL} = 5.0 (max)	5000	△	△	△			△

*: New product

Data Rate: 40 M bps (Typ.)

Part Number	Pin Configuration	Features	Propagation Delay Time (max)		Output Form	@ I _F (mA)	BVs @1min. (Vrms)	Safety Standards ⁽¹⁾					
			t _{pHL} (ns)	t _{pLH} (ns)				UL	c-UL	VDE	BSI	CQC	
TLP2167 **		SO8 • 3.3-V/5-V power supplies • Topr (max) 125°C • Data Rate (Typ. @NRZ) 40 M bps	**	**	Totempole output (Inverter logic)	I _{FHL} = 5.0 (max)	2500	△	△	△			
TLP2367 **		5 pin SO6 • Reinforced insulation • 3.3-V/5-V power supplies • Topr (max) 125°C • Data Rate (Typ. @NRZ) 40 M bps	**	**				△	△	△			
TLP2767 ** TLP2767F **		SDIP6 • 3.3-V/5-V power supplies • Topr (max) 125°C • Data Rate (Typ. @NRZ) 40 M bps	**	**				△	△	△			

**: Under development

Data Rate: 50 M bps (Typ.)

Part Number	Pin Configuration	Features	Propagation Delay Time (max)		Output Form	@ I _F (mA)	BVs @1min. (Vrms)	Safety Standards ⁽¹⁾					
			t _{pHL} (ns)	t _{pLH} (ns)				UL	c-UL	VDE	BSI	CQC	
TLP117		5 pin MFSOP6 • Ultra-high-speed • Data Rate (Typ. @NRZ) 50 M bps	30	30	Totempole output (Inverter logic)	I _{FHL} = 5.0 (max)	3750	○	○	○			













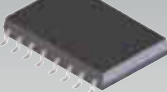

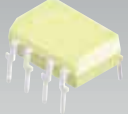

JEDEC Type

Part Number	Pin Configuration	Features	Propagation Delay Time (max)		CTR		BVs @1min. (Vrms)	Safety Standards ⁽¹⁾					
			t _{pHL} (μs)	t _{pLH} (μs)	min (%)	@ I _F (mA)		UL	c-UL	VDE	BSI	CQC	
6N135		DIP8 • JEDEC-compliant • Data Rate (Typ. @NRZ) 1 M bps	1.5	1.5	7	16	2500	○					
6N136			0.8	0.8	19			○					○
6N137	DIP8 • JEDEC-compliant • High-speed • Data Rate (Typ. @NRZ) 10 M bps	0.075	0.075	1000 (Typ.)	5	○							
6N138	DIP8 • JEDEC-compliant • High-CTR • Data Rate (Typ. @NRZ) 300 K bps	10	35	300	1.6	○							
6N139		25	60	400	0.5	○							

Note (1): Please refer to page 43.

IC Output <IGBT / MOSFET Gate Drive>

Selection Table

Output Peak Current (max) (A)								
	5 pin SO6	SO8	SO6L	SO16L	SDIP6 (F type)		DIP8 (F type)	
±0.3							TLP557	
±0.6	TLP151A TLP155 TLP155E	TLP2451A 	TLP5701		TLP701 TLP701A TLP701H  TLP705A	TLP701F TLP701AF TLP701HF  TLP705AF	TLP351 TLP351A TLP351H 	TLP351F TLP351AF TLP351HF 
±1.0			TLP5751 *					
±2.0					TLP700	TLP700F		
±2.5	TLP152		TLP5702 TLP5752 *		TLP700A TLP700H 	TLP700AF TLP700HF 	TLP250H  TLP350H TLP352 	TLP250HF  TLP350HF TLP352F 
±4.0			TLP5754 *	TLP5214 *				
±6.0							TLP358 TLP358H 	TLP358F TLP358H 

: Photocouplers with a maximum operating temperature (Topr.) of 125°C
*: New product

Selection Guide

IGBT/MOSFET Gate Drive

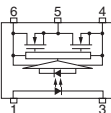
Part Number	Pin Configuration	Features	Propagation Delay Time (max)		Peak Output Current (max) I _{OP} (A)	Threshold input current (max) I _{FLH} (mA)	BV _s @1min. (V _{rms})	Safety Standards ⁽¹⁾				
			t _{pHL} (μs)	t _{pLH} (μs)				UL	c-UL	VDE	BSI	CQC
TLP151A		5 pin SO6 • Reinforced insulation • Topr (max) 110°C • Direct drive of a small-power IGBT/MOSFET	0.45	0.45	±0.6	5	3750	○	○	□		
TLP152		5 pin SO6 • Reinforced insulation • Topr (max) 100°C • Direct drive of a medium-power IGBT/MOSFET	0.19	0.17	±2.5			○	○	□		○
TLP155						7.5		○	○	□		
TLP155E		5 pin SO6 • Reinforced insulation • Topr (max) 100°C • Direct drive of a small-power IGBT/MOSFET	0.2	0.2	±0.6			○	○	□		○

Note (1): Please refer to page 43.

IGBT/MOSFET Gate Drive

Part Number	Pin Configuration	Features	Propagation Delay Time (max)		Peak Output Current (max) I _{OP} (A)	Threshold input current (max) I _{FLH} (mA)	BV _s @1min. (V _{rms})	Safety Standards ⁽¹⁾				
			t _{pHL} (μs)	t _{pLH} (μs)				UL	c-UL	VDE	BSI	CQC
TLP250H TLP250HF		DIP8 • Topr (max) 125°C • Direct drive of a medium-power IGBT/MOSFET	0.5	0.5	±2.5	5	3750	○	○	□		
TLP350H TLP350HF		DIP8 • Topr (max) 125°C • Direct drive of a medium-power IGBT/MOSFET						○	○	□		○
TLP351 TLP351F		DIP8 • Direct drive of a small-power IGBT/MOSFET	0.7	0.7	±0.6			○	○	○		
TLP351A TLP351AF			0.5	0.5				○	○	○		
TLP351H TLP351HF			DIP8 • Topr (max) 125°C • Direct drive of a small-power IGBT/MOSFET	0.7				0.7	○	○	□	
TLP352 TLP352F		DIP8 • Topr (max) 125°C • Direct drive of a medium-power IGBT/MOSFET	0.2	0.2	±2.5			○	○	□		○
TLP358 TLP358F		DIP8 • Direct drive of a medium-power IGBT/MOSFET	0.5	0.5	±6.0			○	○	□		
TLP358H TLP358HF		DIP8 • Topr (max) 125°C • Direct drive of a medium-power IGBT/MOSFET						○	○	□		○
TLP557		DIP8 • Direct drive of a power transistor	5	5	±0.3			2500	○	○		
TLP700 TLP700F		SDIP6 • Direct drive of a medium-power IGBT/MOSFET • SDIP6 version of the TLP350	0.5	0.5	±2.0			5000	○	○	○	
TLP700A TLP700AF		SDIP6 • Direct drive of a medium-power IGBT/MOSFET • SDIP6 version of the TLP352	0.2	0.2	±2.5	○	○		○		○	
TLP700H TLP700HF		SDIP6 • Topr (max) 125°C • Direct drive of a medium-power IGBT/MOSFET • SDIP6 version of the TLP350H	0.5	0.5		○	○		○			

Note (1): Please refer to page 43.

IGBT/MOSFET Gate Drive













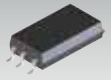

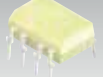
Part Number	Pin Configuration	Features	Propagation Delay Time (max)		Peak Output Current (max) I _{OP} (A)	Threshold input current (max) I _{FLH} (mA)	BV _s @1min. (Vrms)	Safety Standards ⁽¹⁾				
			t _{pHL} (μs)	t _{pLH} (μs)				UL	c-UL	VDE	BSI	CQC
TLP701 TLP701F		SDIP6 • Direct drive of a small-power IGBT/MOSFET • SDIP6 version of the TLP351	0.7	0.7	±0.6	5	5000	○	○	○		
TLP701A TLP701AF		SDIP6 • Direct drive of a small-power IGBT/MOSFET • SDIP6 version of the TLP351A	0.5	0.5				○	○	○		
TLP701H TLP701HF		SDIP6 • Topr (max) 125°C • Direct drive of a small-power IGBT/MOSFET • SDIP6 version of the TLP351H	0.7	0.7				○	○	○		
TLP705A TLP705AF		SDIP6 • High-speed • Direct drive of a small-power IGBT/MOSFET	0.2	0.2				○	○	○		
TLP2451A		SO8 • Topr (max) 125°C • Direct drive of a small-power IGBT/MOSFET • SO8 version of the TLP351A	0.5	0.5		5	3750	○	○	○		
TLP5214 *		SO16L • Topr (max) 110°C • Smart gate drive photocoupler • Overcurrent protection • Soft shutdown • Active miller clamp • Direct drive of a medium-power IGBT/MOSFET • Rail to Rail output	0.15	0.15	±4.0	6		△	△	△		○
TLP5701		SO6L • Topr (max) 110°C • Direct drive of a medium-power IGBT/MOSFET • SO6L version of the TLP351A	0.5	0.5	±0.6	5	5000	○	○	△		○
TLP5702		SO6L • Topr (max) 110°C • Direct drive of a medium-power IGBT/MOSFET • SO6L version of the TLP352	0.2	0.2	±2.5			○	○	□		○
TLP5751 *		SO6L • Topr (max) 110°C • Direct drive of a medium-power IGBT/MOSFET • Rail to Rail output	0.15	0.15	±1.0	4		○	○	□		○
TLP5752 *					±2.5			○	○	□		○
TLP5754 *					±4.0			○	○	□		○

Note (1): Please refer to page 43.

*: New product

IC Output <IPM-Drive>

Selection Table

Data Rate (Typ.)	Output							
		5 pin SO6	SO8	SO6L	(F type)		(F type)	
1 Mbit/s	Open-collector	TLP104  TLP109 (IGM)	TLP2404 	TLP2704 *	TLP714 TLP719	TLP714F TLP719F	TLP559 (IGM) TLP754 TLP759 (IGM)	TLP754F TLP759F (IGM)
5 Mbit/s	Totem-pole	TLP2355  TLP2358 	TLP2405 TLP2408		TLP715 TLP718	TLP715F TLP718F	TLP2955  TLP2958 	TLP2955F  TLP2958F 
10 Mbit/s	Open-collector	TLP2345 TLP2348		TLP2745 **  TLP2748 **				

: Photocouplers with a maximum operating temperature (Topr.) of 125°C

: Photocouplers with low input current.

*: New product **: Under development

Selection Guide

IPM Drive

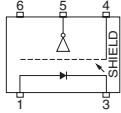
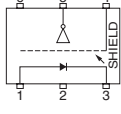
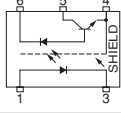
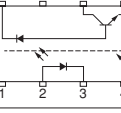
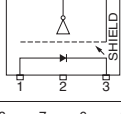
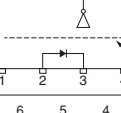
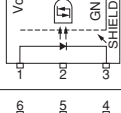
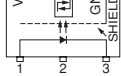
Part Number	Pin Configuration	Features	Propagation Delay Time (max)		CTR / Output form		BVs @1min. (Vrms)	Safety Standards ⁽¹⁾				
			t _{pHL} (μs)	t _{pLH} (μs)	min	@ I _F (mA)		UL	c-UL	VDE	BSI	CQC
TLP104		5 pin SO6 • Reinforced insulation • Topr (max) 125°C • Data Rate (Typ. @NRZ) 1 M bps	0.4	0.55	Open-collector output (Inverter logic)	I _{FHL} = 5.0 (max)	3750	○	○	□		○
TLP2704 *		SO6L • Reinforced insulation • Topr (max) 125°C • SO6L version of the TLP104						5000	○	○	△	
TLP109(IGM)		5 pin SO6 • Reinforced insulation • Data Rate (Typ. @NRZ) 1 M bps	0.8	0.8	25%	10	3750	○	○	□		○
TLP559(IGM)		DIP8 • High CMR version of the TLP550						2500	○	○		
TLP714 TLP714F		SDIP6 • SDIP6 version of the TLP104 • Data Rate (Typ. @NRZ) 1 M bps	0.4	0.55	Open-collector output (Inverter logic)	I _{FHL} = 5.0 (max)	5000	○	○	○		
TLP754 TLP754F		DIP8 • DIP8 version of the TLP104 • Data Rate (Typ. @NRZ) 1 M bps						○	○	□		
TLP715 TLP715F		SDIP6 • High CMR • Direct drive of an IPM	0.25	0.25	Totem-pole output (Buffer logic)	I _{FLH} = 3 (max)	5000	○	○	○		
TLP718 TLP718F		• Data Rate (Typ. @NRZ) 5 M bps			Totem-pole output (Inverter logic)			I _{FLH} = 3 (max)	○	○	○	

Note (1): Please refer to page 43.

*: New product

IPM Drive

Part Number	Pin Configuration	Features	Propagation Delay Time (max)		CTR / Output form		BVs @1min. (Vrms)	Safety Standards ⁽¹⁾				
			t _{pHL} (μs)	t _{pLH} (μs)	min	@ I _F (mA)		UL	c-UL	VDE	BSI	CQC
TLP719 TLP719F		SDIP6 • Direct drive of an IPM • Data Rate (Typ. @NRZ) 1 M bps	0.8	0.8	20	16	5000	○	○	○		
TLP759(IGM) TLP759F(IGM)		DIP8 • Data Rate (Typ. @NRZ) 1 M bps	0.8	0.8	25%	10	5000	○	○	○	○	
TLP2345		5 pin SO6 • Reinforced insulation • High-speed • Direct drive of an IPM	0.12	0.12	Totem pole output (Buffer logic)	I _{FLH} = 1.6 (max)	3750	○	○	□		△
TLP2348		• Data Rate (Typ. @NRZ) 10 M bps			Totem pole output (Inverter logic)	I _{FLH} = 1.6 (max)		○	○	□		△
TLP2355		5 pin SO6 • Reinforced insulation • V _{CC} = 3.0~20-V • Direct drive of an IPM	0.25	0.25	Totem pole output (Buffer logic)	I _{FLH} = 1.6 (max)		○	○	□		○
TLP2358		• Data Rate (Typ. @NRZ) 5 M bps			Totem pole output (Inverter logic)	I _{FLH} = 1.6 (max)		○	○	□		○
TLP2404		SO8 • Topr (max) 125°C • SO8 version of the TLP104 • Data Rate (Typ. @NRZ) 1 M bps	0.4	0.55	Open-collector output (Inverter logic)	I _{FLH} = 5.0 (max)		○	○	○		
TLP2405		SO8 • Low input current • Direct drive of an IPM • Data Rate (Typ. @NRZ) 5 M bps	0.25	0.25	Totem pole output (Buffer logic)	I _{FLH} = 1.6 (max)		○	○	○		
TLP2408					Totem pole output (Inverter logic)	I _{FLH} = 1.6 (max)		○	○	○		
TLP2745 *		SO6L • Reinforced insulation • High-speed • Direct drive of an IPM • SO6L version of the TLP2345 • Data Rate (Typ. @NRZ) 10 M bps	0.12	0.12	Totem pole output (Buffer logic)	I _{FLH} = 1.6 (max)		5000	○	○	□	
TLP2748 *					Totem pole output (Inverter logic)	I _{FLH} = 1.6 (max)	△		△	△		△

Note (1): Please refer to page 43.

*: New product

IPM Drive

Part Number	Pin Configuration	Features	Propagation Delay Time (max)		CTR / Output form		BVs @1min. (Vrms)	Safety Standards ⁽¹⁾				
			t _{pHL} (μs)	t _{pLH} (μs)	min	@ I _F (mA)		UL	c-UL	VDE	BSI	CQC
TLP2955 TLP2955F		DIP8 • Topr (max) 125°C • Low input current • Direct drive of an IPM • Data Rate (Typ. @NRZ) 5 M bps	0.25	0.25	Totem pole output (Buffer logic)	I _{FLH} = 1.6 (max)	5000	○	○	□		
TLP2958 TLP2958F					Totem pole output (Inverter logic)	I _{FLH} = 1.6 (max)		○	○	□		

Transistor Output

Selection Table

DC Input Type

		SO4	4pin SO6	4pin SO6L	SO16 (4channel)	DIP4 F type	DIP6
General-Purpose	2500 Vrms				TLP291-4		
	3750 Vrms	TLP291 (SE *■)	TLP185 (SE *■)				
	4000 Vrms						TLP731 TLP732
	5000 Vrms			TLP385 *●		TLP785 TLP785F	
Low I _F	3750 Vrms	TLP293 *■ ■	TLP183 *■ ■ ■ TLP2301 ■ ■ ■ ■ ■		TLP293-4 *■ ■ ■		
	5000 Vrms			TLP383 *● ■ ■			
High V _{CEO}			TLP188 *■				
Darlington	High V _{CEO}		TLP187 ■				
		5000 Vrms				TLP627	

*: New product

AC Input Type

		SO4	4pin SO6	SO16 (4channel)
General-Purpose	2500 Vrms			TLP290-4
	3750 Vrms	TLP290(SE *■)	TLP184(SE *■)	TLP292-4 *■ ■ ■
Low I _F	3750 Vrms	TLP292 *■ ■ ■	TLP182 *■ ■ ■	

- : Reinforced insulation.
(Creepage distances and Clearance 8 mm)
- : Reinforced insulation.
(Creepage distances and Clearance 5 mm)
- : Photocouplers with a maximum operating temperature of 125°C
- : Built-in R_{BE}

*: New product

Selection Guide

DC Input Type

Part Number	Pin Configuration	Features	CTR					V _{CEO} (V)	BV _s @1min. (Vrms)	Safety Standards ⁽¹⁾				
			Rank	min (%)	max (%)	@ I _F (mA)	@ V _{CE} (V)			UL	c-UL	VDE	BSI	CQC
TLP183 *		4 pin SO6 • Reinforced insulation • Low input drive current • Topr = 125°C (max)	—	50	600	0.5	5	80	3750	○	○	□	○	
			Y	50	150									
			YH	75	150									
			GR	100	300									
			GRL	100	200									
			GRH	150	300									
			GB	100	600									
			BL	200	600									
BLL	200	400												
TLP185(SE) *		4 pin SO6 • Reinforced insulation • General-purpose	—	50	600	5	5	80	3750	○	○	□	○	
			Y	50	150									
			YH	75	150									
			GR	100	300									
			GRL	100	200									
			GRH	150	300									
			GB	100	600									
			BL	200	600									
BLL	200	400												
TLP188 *		4 pin SO6 • Reinforced insulation • High V _{CEO}	—	50	600	5	5	350	○	○	□	△		
			GB	100	600									
TLP291-4		SO16 • 4-channel version equivalent of the TLP291 • Lead pitch: 1.27 mm	—	50	400	5	5	80	2500	○	○	○		
			GB	100	600									
TLP291(SE) *		SO4 • Reinforced insulation • Lead pitch: 1.27 mm	—	50	600	5	5	80	3750	○	○	□	○	
			Y	50	150									
			YH	75	150									
			GR	100	300									
			GRL	100	200									
			GRH	150	300									
			GB	100	600									
			BL	200	600									
BLL	200	400												
TLP293 *		SO4 • Reinforced insulation • Low input drive current • Topr = 125°C (max)	—	50	600	0.5	5	80	3750	○	○	□	○	
			Y	50	150									
			YH	75	150									
			GR	100	300									
			GRL	100	200									
			GRH	150	300									
			GB	100	600									
			BL	200	600									
BLL	200	400												
TLP293-4 *		SO16 • Reinforced insulation • 4-channel version equivalent of the TLP293 • Lead pitch: 1.27 mm • Low input drive current • Topr = 125°C (max)	LA	50	600	0.5	5	80	3750	○	○	□	○	
			LGB	100	600									

Note (1): Please refer to page 43.

*: New product

DC Input Type

Part Number	Pin Configuration	Features	CTR					V_{CE0} (V)	BVs @1min. (Vrms)	Safety Standards ⁽¹⁾				
			Rank	min (%)	max (%)	@ I_F (mA)	@ V_{CE} (V)			UL	c-UL	VDE	BSI	CQC
TLP383		4 pin SO6L • Guarantees a creepage and clearance distance of 8 mm (min) • Low input drive current • $T_{opr} = 125^{\circ}\text{C}$ (max)	—	50	600	0.5	5	80	5000	○	○	□	○	△
			Y	50	150									
			YH	75	150									
			GR	100	300									
			GRL	100	200									
			GRH	150	300									
			GB	100	600									
			BL	200	600									
TLP385		4 pin SO6L • Guarantees a creepage and clearance distance of 8 mm (min)	—	50	600	5	5	80	5000	○	○	□	○	○
			Y	50	150									
			YH	75	150									
			GR	100	300									
			GRL	100	200									
			GRH	150	300									
			GB	100	600									
			BL	200	600									
TLP731		DIP6 • Internal base connection	—	50	600	5	5	55	4000	○	○	○	○	○
			GR	100	300									
			GB	100	600									
TLP732		DIP6 • No internal base connection	—	50	600	5	5	55	4000	○	○	○	○	○
			GR	100	300									
			GB	100	600									
TLP785 TLP785F		DIP4 • High isolation voltage	—	50	600	5	5	80	5000	○	○	□	○	○
			Y	50	150									
			YH	75	150									
			GR	100	300									
			GRL	100	200									
			GRH	150	300									
			GB	100	600									
			BL	200	600									
BLL	200	400												
TLP2301		4 pin SO6 • Reinforced insulation • Low input drive current • Built-in R_{BE} • $T_{opr} = 125^{\circ}\text{C}$ (max) • Equivalent to the TLP2301 with the IC output.	—	50	600	1	5	40	3750	○	○	□	○	△
			GB	100	600									

Note (1)(3): Please refer to page 43.

*: New product

AC Input Type

Part Number	Pin Configuration	Features	CTR					V_{CE0} (V)	BVs @1min. (Vrms)	Safety Standards ⁽¹⁾				
			Rank	min (%)	max (%)	@ I _F (mA)	@ V _{CE} (V)			UL	c-UL	VDE	BSI	CQC
TLP182 *		4 pin SO6 • Reinforced insulation • Low input drive current • Topr = 125°C (max)	—	50	600	±0.5	5	80	3750	○	○	□	○	○
			Y	50	150									
			GR	100	300									
			GB	100	600									
TLP184(SE) *		4 pin SO6 • Reinforced insulation	—	50	600	±5	5	80	3750	○	○	□	○	○
			Y	50	150									
			GR	100	300									
			GB	100	600									
TLP290-4		SO16 • 4-channel version equivalent of the TLP290 • Lead pitch: 1.27 mm	—	50	400	±5	5	80	2500	○	○	○	○	○
			GB	100	400									
TLP290(SE) *		SO4 • Reinforced insulation • Lead pitch: 1.27 mm	—	50	600	±5	5	80	3750	○	○	□	○	○
			Y	50	150									
			GR	100	300									
			GB	100	600									
TLP292 *		SO4 • Reinforced insulation • Low input drive current • Topr = 125°C (max)	—	50	600	±0.5	5	80	3750	○	○	□	○	○
			Y	50	150									
			GR	100	300									
			GB	100	600									
TLP292-4 *		SO16 • Reinforced insulation • 4-channel version equivalent of the TLP292 • Low input drive current • Lead pitch: 1.27 mm • Topr = 125°C (max)	LA	50	600	±0.5	5	80	3750	○	○	□	○	○
			LGB	100										

*: New product



Darlington Transistor Output Type

Part Number	Pin Configuration	Features	CTR			$V_{CE(sat)}$			V_{CE0} (V)	BVs @1min. (Vrms)	Safety Standards ⁽¹⁾				
			min (%)	@ I _F (mA)	@ V _{CE} (V)	max (V)	@ I _c (mA)	@ I _F (mA)			UL	c-UL	VDE	BSI	CQC
TLP187		4 pin SO6 • Reinforced insulation • High V_{CE0}	1000	1	1	1.2	100	10	300	3750	○	○	□	△	○
TLP627		DIP4 • High V_{CE0}	1000	1	1	1.2	100	10	300	5000	○	○	○	○	

Note (1): Please refer to page 43.

Triac Output

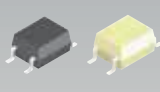
Selection Table

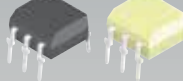
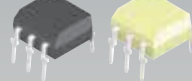
											
VDRM	Isolation Voltage	NZC / ZC	4 pin SO6	4 pin MFSOP6 (No5 cut)	DIP4		5 pin DIP6		5 pin DIP6 (cut)		
						F type		F type		F type	
400 V	2500 Vrms	NZC			TLP525G				TLP560G		
		ZC							TLP561G		
	5000 Vrms	NZC							TLP3022(S) TLP3023(S) TLP665G(S)	TLP3022F(S) TLP3023F(S) TLP665GF(S)	
		ZC							TLP3042(S) TLP3043(S) TLP666G(S)	TLP3042F(S) TLP3043F(S) TLP666GF(S)	
600 V	2500 Vrms	NZC							TLP560J		
		ZC		TLP163J					TLP561J		
	3750 Vrms	NZC	TLP265J *■ TLP267J *■								
		ZC	TLP266J *■ TLP268J *■								
	4000 Vrms	NZC					TLP762J	TLP762JF			
		ZC					TLP763J	TLP763JF			
	5000 Vrms	NZC			TLP360J	TLP360JF	TLP3052A **		TLP665J(S)	TLP665JF(S)	
		ZC			TLP361J TLP363J	TLP361JF TLP363JF	TLP3062A **		TLP3062(S) TLP3063(S) TLP3064(S) TLP663J(S) TLP666J(S) TLP668J(S)	TLP3062F(S) TLP3063F(S) TLP3064F(S) TLP663JF(S) TLP666JF(S) TLP668JF(S)	
800 V	5000 Vrms	NZC						TLP3073 **	TLP665L		
		ZC					TLP3782(S) TLP3783(S) TLP3083 **	TLP3782F(S) TLP3783F(S)	TLP669L(S) TLP3082(S) TLP666L(S)	TLP669LF(S) TLP3082F(S) TLP666LF(S)	

■: Reinforced Insulation
*: New product **: Under development

Selection Guide

V_{DRM} = 400 V

Part Number	Pin Configuration	Features	Trigger LED Current		Peak On-state Voltage		Off-state Output Terminal Voltage	BV _s @1min. (Vrms)	Safety Standards ⁽¹⁾									
			Rank	max (mA)	max (V)	@ I _{TM} (mA)			V _{DRM} (V)	UL	c-UL	VDE	BSI	CQC				
															I _{FT}	V _{TM}		
TLP525G		DIP4 • Non-zero cross	—	10	3.0	100	400	2500	○	○								
TLP560G		5 pin DIP6 (cut) • General-purpose • Non-zero cross	—	10	3.0	100	400	2500	○	○	○							
			IFT7	7														
			IFT5	5														
TLP561G		5 pin DIP6 (cut) • General-purpose • Zero cross	—	10	3.0	100	400	2500	○	○	○							
			IFT7	7														
			IFT5	5														
TLP3022(S) TLP3022F(S)		5 pin DIP6 (cut) • Non-zero cross	—	10	3.0	100	400	5000	○	○	○	○						
TLP3023(S) TLP3023F(S)			—	5										5000	○	○	○	○
TLP3042(S) TLP3042F(S)			—	10														
TLP3043(S) TLP3043F(S)	—	5	5000	○	○	○	○											



V_{DRM} = 600 V

Part Number	Pin Configuration	Features	Trigger LED Current		Peak On-state Voltage		Off-state Output Terminal Voltage	BV _s @1min. (Vrms)	Safety Standards ⁽¹⁾					
			Rank	max (mA)	max (V)	@ I _{TM} (mA)			V _{DRM} (V)	UL	c-UL	VDE	BSI	CQC
TLP163J		4 pin MFSOP6 (cut) • Zero cross • High impulse noise immunity • V _N = 2000 V (typ.)	—	10	2.8	70	600	2500	○	○	△			
TLP265J *		4 pin SO6 • Reinforced insulation • Non-zero cross	—	10	2.8	70	600	3750	○	○	□		○	
			IFT7	7										
TLP266J *		4 pin SO6 • Reinforced insulation • Zero cross	—	10	2.8	70	600	3750	○	○	□		○	
			IFT7	7										
TLP267J *		4 pin SO6 • Reinforced insulation • Non-zero cross • Low trigger LED current	—	3	2.8	70	600	3750	○	○	□		○	
			IFT2	2										

Note (1): Please refer to page 43.

*: New product

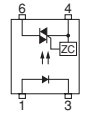
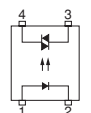
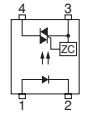
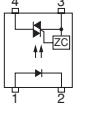
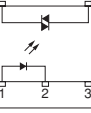
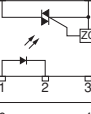
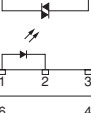
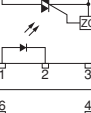
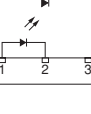
$V_{DRM} = 600\text{ V}$

Part Number	Pin Configuration	Features	Trigger LED Current		Peak On-state Voltage		Off-state Output Terminal Voltage	BVs @1min.	Safety Standards ⁽¹⁾				
			I_{FT}		V_{TM}				V_{DRM} (V)	(Vrms)	UL	c-UL	VDE
			Rank	max (mA)	max (V)	@ I_{TM} (mA)							
TLP268J *		4 pin SO6 • Reinforced insulation • Zero cross • Low trigger LED current	—	3	2.8	70	600	3750	○	○	□		○
			IFT2	2									
TLP360J TLP360JF		DIP4 • Non-zero cross	—	10	3.0	100	600	5000	○	○	○		○
			IFT7	7									
TLP361J TLP361JF		DIP4 • Zero cross	—	10	3.0	100	600	5000	○	○	○		○
			IFT7	7									
TLP363J TLP363JF		DIP4 • Zero cross • High impulse noise immunity • $V_N = 2000\text{ V}$ (typ.)	—	10	3.0	100	600	5000	○	○	○		○
			IFT7	7									
TLP560J		5 pin DIP6 (cut) • General-purpose • Non-zero cross	—	10	3.0	100	600	2500	○	○	○		
			IFT7	7									
TLP561J		5 pin DIP6 (cut) • General-purpose • Zero cross	—	10	3.0	100	600	2500	○	○	○		
			IFT7	7									
TLP762J TLP762JF		5 pin DIP6 • Non-zero cross	—	10	3.0	100	600	4000	○	○	○	○	
			IFT7	7									
TLP763J TLP763JF		5 pin DIP6 • Zero cross	—	10	3.0	100	600	4000	○	○	○	○	
			IFT7	7									
TLP3052A **		5 pin DIP6 • Non-zero cross	—	10	3.0	100	600	5000	△	△	△		△
TLP3062(S) TLP3062F(S)		5 pin DIP6 (cut) • High V_{DRM} • Zero cross	—	10					○	○	○	○	○
TLP3062A **		5 pin DIP6 • Zero cross	—	10					△	△	△		△
TLP3063(S) TLP3063F(S)		5 pin DIP6 (cut) • High V_{DRM} • Zero cross	—	5					○	○	○	○	○
TLP3064(S) TLP3064F(S)		5 pin DIP6 (cut) • Zero cross	—	3					○	○	○	○	

Note (1): Please refer to page 43.

*: New product **: Under development

$V_{DRM} = 800\text{ V}$

Part Number	Pin Configuration	Features	Trigger LED Current I_{FT}		Peak On-state Voltage V_{TM}		Off-state Output Terminal Voltage V_{DRM} (V)	BVs @1min. (Vrms)	Safety Standards ⁽¹⁾				
			Rank	max (mA)	max (V)	@ I_{TM} (mA)			UL	c-UL	VDE	BSI	CQC
TLP3073 **		5 pin DIP6 • Non-zero cross	—	5	3.0	100	800	5000	△	△	△		△
TLP3082(S) TLP3082F(S)		5 pin DIP6 (cut) • Zero cross	—	10					○	○	○	○	
TLP3083 **		5 pin DIP6 • Zero cross	—	5					△	△	△		△
TLP3782(S) TLP3787F(S)		5 pin DIP6 • Zero cross • High impulse noise immunity • $V_N = 1500\text{ V (typ.)}$	—	10					○	○	○		
TLP3783(S) TLP3783F(S)			—	5					○	○	○		

** : Under development

Product for Japan



Part Number	Pin Configuration	Features	Trigger LED Current I_{FT}		Peak On-state Voltage V_{TM}		Off-state Output Terminal Voltage V_{DRM} (V)	BVs @1min. (Vrms)	Safety Standards ⁽¹⁾				
			Rank	max (mA)	max (V)	@ I_{TM} (mA)			UL	c-UL	VDE	BSI	CQC
TLP663J(S) TLP663JF(S)		5 pin DIP6 (cut) • Zero cross • High impulse noise immunity • $V_N = 2000\text{ V (typ.)}$	—	10	3.0	100	600	5000	○	○	○	△	
TLP665G(S) TLP665GF(S)		5 pin DIP6 (cut) • Non-zero cross	—	10	3.0	100	400	5000	○	○	○	○	○
TLP665J(S) TLP665JF(S)		5 pin DIP6 (cut) • High V_{DRM} • Non-zero cross	IFT7	7			600						
TLP665L * ⁽⁴⁾		5 pin DIP6 (cut) • Non-zero cross	IFT7	7			800						
TLP666G(S) TLP666GF(S)		5 pin DIP6 (cut) • Zero cross	IFT7	7			400						
TLP666J(S) TLP666JF(S)		5 pin DIP6 (cut) • High V_{DRM} • Zero cross	—	10	3.0	100	600	5000	○	○	○	○	○
TLP666L(S) TLP666LF(S)		5 pin DIP6 (cut) • Zero cross	—	10			800						
TLP668J(S) TLP668JF(S)		5 pin DIP6 (cut) • Zero cross	—	3			600						
TLP669L(S) TLP669LF(S)		5 pin DIP6 (cut) • Zero cross • High impulse noise immunity • $V_N = 1500\text{ V (typ.)}$	IFT5	5			800						

Note (1)(4): Please refer to page 43.

*: New product

Thyristor Output

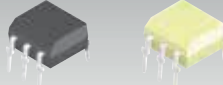
Selection Table

				
V_{DRM}	Isolation Voltage	5 pin MFSOP6	DIP6	7 pin DIP8
			F type	
400 V	2500 Vrms	TLP148G		
600 V	2500 Vrms		TLP548J	TLP549J
	4000 Vrms		TLP748J	TLP748JF



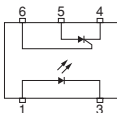
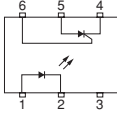
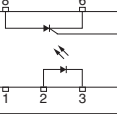
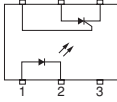

Selection Guide

Part Number	Pin Configuration	Features	Trigger LED Current I_{FT} max (mA)	Peak On-state Voltage V_{TM}		Off-state Output Terminal Voltage V_{DRM} (V)	BVs @1min. (Vrms)	Safety Standards ⁽¹⁾				
				max (V)	@ I_{TM} (mA)			UL	c-UL	VDE	BSI	CQC
TLP148G		5 pin MFSOP6 • General-purpose	10	1.45	100	400	2500	○	○			
TLP548J		DIP6 • General-Purpose • Low trigger current	7	1.45	100	600	2500	○	△			
TLP549J		7 pin DIP8 • Long anode-cathode distance (SCR)	7	1.45	100	600	2500	○	△			
TLP748J TLP748JF		DIP6	10	1.45	100	600	4000	○	○	○	○	

Note (1): Please refer to page 43.

Photovoltaic Output

Selection Table

						
Open Voltage (Min)	Isolation Voltage	Short-Circuit current (Min)	SSOP4	4 pin SO6	4 pin MFSOP6	5 pin DIP6 (cut)
7 V	1500 Vrms	5 μ A	TLP3904			
		20 μ A	TLP3914			
	2500 Vrms	5 μ A			TLP3902	
		12 μ A			TLP190B	TLP590B
		24 μ A			TLP191B	TLP591B
3750 Vrms	12 μ A		TLP3905 			
30 V	1500 Vrms	4 μ A	TLP3924			

: Photocouplers with a maximum operating temperature (Topr.) of 125°C

Selection Guide

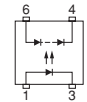
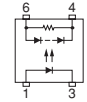
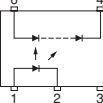
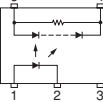
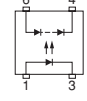
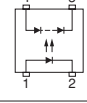
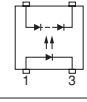
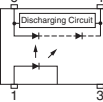
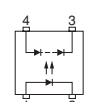
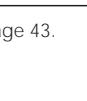







Part Number	Pin Configuration	Features	Short-Circuit Current			Open Voltage		BVs @1min. (Vrms)	Safety Standards ⁽¹⁾				
			Rank	Isc min (μ A)	@ If (mA)	Voc min (V)	@ If (mA)		UL	c-UL	VDE	BSI	CQC
TLP190B		4 pin MFSOP6	—	12	10	7	10	2500	○	○			
			C20	20									
TLP191B		4 pin MFSOP6 • Built-in shunt resistor	—	24	20	20		○	○				
TLP590B		5 pin DIP6 (cut) • General-purpose	—	12	10	7	10	2500	○				
			C20	20									
TLP591B		5 pin DIP6 (cut) • Built-in shunt resistor	—	24	20	20		○					
TLP3902		4 pin MFSOP6 • General-purpose	—	5	10	7	10	2500	○	○			
TLP3904		SSOP4 • General-purpose	—	5	10	7	10	1500	○				
TLP3905		4 pin SO6 • General-purpose • Topr = 125°C (max)	—	12	10	7	10	3750	○	○	□		
			C20	20									
TLP3906		4 pin SO6 • Built-in discharging circuit • Topr = 125°C (max)	—	12	20	20		○	○	□			
			C20	20									
TLP3914		SSOP4 • High output	—	20	10	7	10	1500	○				
TLP3924		SSOP4 • High open-circuit voltage	—	4	10	30	10	1500	○				

Note (1): Please refer to page 43.









Photorelays

Selection Table

1-Form-A

													
V _{OFF} (max)V	R _{ON} (max) Ω	I _{ON} (max)A	VSON4	USOP4	SSOP4	4 pin SO6	2.54SOP4	2.54SOP6	2.54SOP8	DIP4		DIP6	
										F type		F type	
20	8	±0.16		TLP3330	TLP3230		TLP3130						
	5	±0.2	TLP3450 *	TLP3350	TLP3250								
	1.2	±0.3					TLP3131						
	1.2	±0.45	TLP3431 **	TLP3331 **	TLP3231								
	0.22	±0.9		TLP3303	TLP3203								
	0.22	±1	TLP3403 *										
	0.08	±3.0								TLP3553			
	0.05	±2.5						TLP3100					
	0.05	±4.0										TLP3543	
30	0.04	±4.0						TLP3106 *					
40	20	±0.1	TLP3442 *	TLP3342									
	15	±0.12			TLP3216		TLP3116						
	14	±0.12	TLP3440 *	TLP3340	TLP3240								
	10	±0.14	TLP3441 *	TLP3341	TLP3241								
	5	±0.2											
	3	±0.25			TLP3214		TLP3114						
	1.5	±0.3		TLP3315	TLP3215		TLP3115						
	0.2	±2.0								TLP241A **■	TLP241AF **■		
	0.15	±2.0								TLP221A ■	TLP221AF ■		
	0.15	±2.5								TLP3554			
	0.13	±1.0					TLP3123						
50	0.06	±2.5						TLP3102					
	0.06	±3.5										TLP3544	
	1.5	±0.3	TLP3475 *	TLP3375	TLP3275								
	50	±0.1				TLP175A							
	15	±0.12	TLP3451 *	TLP3351									
	2	±0.4					TLP170A TLP171A TLP172A TLP176A	TLP192A TLP197A	TLP202A TLP206A				
	2	±0.5								TLP222A TLP227A TLP240A *■	TLP240AF *■	TLP592A TLP597A TLP598AA	
	1.5	±0.4	TLP3412 *	TLP3312	TLP3212								
	1.1	0.5								TLP225A			
	0.7	±1.0					TLP3122						
60	0.2	±2.0								TLP3555			
	0.13	±1.7					TLP3127 *						
	0.1	±2.5										TLP3542	
	0.07	±2.3						TLP3103					
	0.07	±3.0										TLP3545	
	0.06	±3.3						TLP3107					
	75	2	±0.4		TLP3306								
	80	25	±0.04					TLP3118					
		20	±0.1					TLP3111					
		12	±0.12	TLP3417 *	TLP3317	TLP3217							
8		±0.2	TLP3419 *	TLP3319			TLP3119						
1.2		±0.35					TLP3121						
0.15		±1.25						TLP3120					

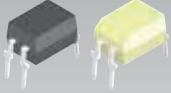
1-Form-A (Continued)

													
V_{OFF} (max)V	R_{ON} (max) Ω	I_{ON} (max)A	VSON4	USOP4	SSOP4	4 pin SO6	2.54SOP4	2.54SOP6	2.54SOP8	DIP4		DIP6	
											F type		F type
100	14	± 0.08			TLP3220								
	14	± 0.1	TLP3420 *	TLP3320									
	0.7	± 1.0								TLP3556			
	0.2	± 1.4							TLP3105				
	0.2	± 2.0										TLP3546	
	0.07	± 2.0							TLP3109 *				
200	50	± 0.05					TLP179D	TLP199D	TLP209D				
	8	± 0.2					TLP170D TLP171D TLP176D	TLP197D	TLP200D				
	8	± 0.25								TLP240D *■	TLP240D *■		
	8	± 0.3								TLP222D			
350	50	± 0.1					TLP170G			TLP240G *■	TLP240GF *■		
	50	± 0.11					TLP172G	TLP192G	TLP202G				
	50	± 0.12								TLP222G TLP228G		TLP592G	
	35	± 0.12					TLP174G TLP176G	TLP197G	TLP206G	TLP224G TLP227G		TLP597G	
400	35	± 0.1					TLP171GA						
	35	± 0.12					TLP174GA TLP176GA	TLP197GA	TLP206GA	TLP224GA TLP227GA TLP240GA *■	TLP240GAF *■	TLP597GA TLP797GA	TLP797GAF
	12	± 0.15										TLP598GA TLP798GA	
	4	± 0.2							TLP3125				
600	60	± 0.07					TLP171J						
	60	± 0.09					TLP170J			TLP240J *■	TLP240JF *■		
	45	± 0.1										TLP797J	TLP797JF

■: Reinforced Insulation
*: New product

2-Form-A

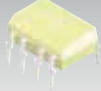
			
V_{OFF} (max)V	R_{ON} (max) Ω	I_{ON} (max)A	DIP8
60	2	± 0.5	TLP222A-2 TLP227A-2
350	50	± 0.12	TLP222G-2 TLP228G-2
	35	± 0.12	TLP224G-2 TLP227G-2
400	35	± 0.12	TLP224GA-2 TLP227GA-2

1-Form-B

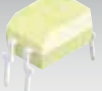
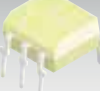
					
V_{OFF} (max)V	R_{ON} (max) Ω	I_{ON} (max)A	2.54SOP4	DIP4	DIP6
350	25	± 0.12	TLP4176G TLP4197G		
		± 0.15		TLP4227G	TLP4597G

2-Form-B

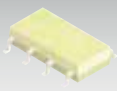
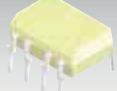
				
V_{OFF} (max)V	R_{ON} (max) Ω	I_{ON} (max)A	2.54SOP8	DIP8
350	25	± 0.12	TLP4206G	
		± 0.15		TLP4227G-2

1-Form-A , 1-Form-B

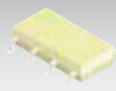
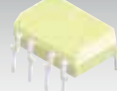
				
V_{OFF} (max)V	R_{ON} (max) Ω	I_{ON} (max)A	2.54SOP8	DIP8
350	25	± 0.12	TLP4006G	TLP4026G

Selection Guide

1-Form-A: VSON4 package

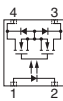
Part Number	Pin Configuration	Features	Trigger LED Current I_{FT} max (mA)	On-State Resistance		On-state Current I_{ON} max (A)	Off-state Voltage V_{OFF} (V)	BVs @1min. (Vrms)	Safety Standards ⁽¹⁾				
				R_{ON} max (Ω)	@ I_F (mA)				UL	c-UL	VDE	BSI	CQC
TLP3403		VSON4 • Low R_{ON} • High I_{ON}	3	0.22	5	± 1	20	300					
TLP3412		VSON4 • Low R_{ON} • 60-V V_{OFF}		1.5		± 0.4	60						
TLP3417		VSON4 • Low CR • C_{OFF} : 5 pF (Typ.)		12		± 0.12	80						
TLP3419		VSON4		8		± 0.2							
TLP3420		VSON4 • 100-V V_{OFF}		14		10	± 0.1		100				
TLP3431		VSON4		1.2		± 0.45	20						
TLP3440		VSON4 • Ultra-low CR: 5 pF Ω • C_{OFF} : 0.45 pF (Typ.)		14		± 0.12	40						
TLP3441		VSON4		10		± 0.14							
TLP3442		VSON4		20		5	± 0.1		20				
TLP3450		VSON4		5		± 0.2							
TLP3451		VSON4		15		± 0.12	60						
TLP3475		VSON4 • C_{OFF} : 12 pF (Typ.)		1.5		± 0.3	50						

*: New product **: Under development

1-Form-A: USOP4 package

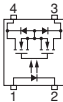
Part Number	Pin Configuration	Features	Trigger LED Current I_{FT} max (mA)	On-State Resistance		On-state Current I_{ON} max (A)	Off-state Voltage V_{OFF} (V)	BVs @1min. (Vrms)	Safety Standards ⁽¹⁾				
				R_{ON} max (Ω)	@ I_F (mA)				UL	c-UL	VDE	BSI	CQC
TLP3303		USOP4 • Ultra-low On-resistance R: 0.18 Ω (Typ.) • High output current I_{ON} : 0.9 A (max)	3	0.22	5	± 0.9	20	500	○				
TLP3306		USOP4 • 75-V V_{OFF}		2		± 0.4	75		○				
TLP3312		USOP4 • C_{OFF} : 20 pF (Typ.)		1.5		± 0.4	60		○				

Note (1): Please refer to page 43.

1-Form-A: USOP4 package

Part Number	Pin Configuration	Features	Trigger LED Current I_{FT} max (mA)	On-State Resistance		On-state Current I_{ON} max (A)	Off-state Voltage V_{OFF} (V)	BVs @1min. (Vrms)	Safety Standards ⁽¹⁾					
				R_{ON} max (Ω)	@ I_F (mA)				UL	c-UL	VDE	BSI	CQC	
TLP3315		USOP4 • Ultra-low CR: 10 pF Ω • C_{OFF} : 10 pF (Typ.)	3	1.5	5	± 0.3	40	500	○					
TLP3317		USOP4 • Low CR: 35 pF Ω • C_{OFF} : 5 pF (Typ.)		12		± 0.12	80		○					
TLP3319		USOP4 • Low CR: 30 pF Ω • C_{OFF} : 6.5 pF (Typ.)		8		± 0.2			○					
TLP3320		USOP4 • 100-V V_{OFF}		14	10	± 0.1	100		○					
TLP3330		USOP4 • Ultra-low CR: 5 pF Ω • C_{OFF} : 1 pF (Typ.)		8	5	± 0.16	20		○					
TLP3331 **		USOP4 • Ultra-low CR: 5 pF Ω • C_{OFF} : 5 pF (Typ.)		1.2		± 0.45				○				
TLP3340		USOP4 • Ultra-low CR: 5 pF Ω • C_{OFF} : 0.45 pF (Typ.)		14		± 0.12				○				
TLP3341		USOP4 • Ultra-low CR: 5 pF Ω • C_{OFF} : 0.7 pF (Typ.)		10		± 0.14	40		○					
TLP3342		USOP4 • Ultra-low C_{OFF} : 0.3 pF (Typ.)		20		± 0.1			○					
TLP3350		USOP4 • Ultra-low CR: 2.5 pF Ω • C_{OFF} : 0.8 pF (Typ.)		5		± 0.2	20		○					
TLP3351		USOP4 • Ultra-low C_{OFF} : 0.7 pF (Typ.)		15		± 0.12	60		○					
TLP3375		USOP4 • C_{OFF} : 12 pF (Typ.)		1.5		± 0.3	50		○					

** : Under development

1-Form-A: SSOP4 package

Part Number	Pin Configuration	Features	Trigger LED Current I_{FT} max (mA)	On-State Resistance		On-state Current I_{ON} max (A)	Off-state Voltage V_{OFF} (V)	BVs @1min. (Vrms)	Safety Standards ⁽¹⁾				
				R_{ON} max (Ω)	@ I_F (mA)				UL	c-UL	VDE	BSI	CQC
TLP3203		SSOP4 • Ultra-low On-resistance R: 0.18 Ω (Typ.) • High output current I_{ON} : 0.9 A (max)	3	0.22	5	± 0.9	20	1500	○				
TLP3212		SSOP4 • Low CR: 20 pF Ω • C_{OFF} : 20 pF (Typ.)	5	1.5		± 0.4	60		○				
TLP3214		SSOP4 • Ultra-low CR: 10 pF Ω • C_{OFF} : 5 pF (Typ.)	4	3		± 0.25	40		○				

Note (1): Please refer to page 43.

1-Form-A: SSOP4 package

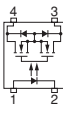
Part Number	Pin Configuration	Features	Trigger LED Current I_{FT} max (mA)	On-State Resistance		On-state Current I_{ON} max (A)	Off-state Voltage V_{OFF} (V)	BVs @1min. (Vrms)	Safety Standards ⁽¹⁾				
				R_{ON} max (Ω)	@ I_F (mA)				UL	c-UL	VDE	BSI	CQC
TLP3215		SSOP4 • Ultra-low CR: 10 pF Ω • C_{OFF} : 10 pF (Typ.)	4	1.5	5	± 0.3	40	1500	○				
TLP3216		SSOP4 • Ultra-low CR: 10 pF Ω • C_{OFF} : 1 pF (Typ.)		15		± 0.12			○				
TLP3217		SSOP4 • Low CR • C_{OFF} : 50 pF (Typ.)	5	12	± 0.12	80	○						
TLP3220		SSOP4 • 100-V V_{OFF}		14	10	± 0.08	100		○				
TLP3230		SSOP4 • Ultra-low CR: 5 pF Ω • C_{OFF} : 1 pF (Typ.)	4	8	± 0.16	20	○						
TLP3231		SSOP4 • Ultra-low CR: 5 pF Ω • C_{OFF} : 5 pF (Typ.)		1.2	± 0.45		○						
TLP3240		SSOP4 • Ultra-low CR: 5 pF Ω • C_{OFF} : 0.45 pF (Typ.)	3	14	± 0.12	40	○						
TLP3241		SSOP4 • Ultra-low CR: 5 pF Ω • C_{OFF} : 0.7 pF (Typ.)		10	± 0.14		○						
TLP3250		SSOP4 • Ultra-low CR: 2.5 pF Ω • C_{OFF} : 0.8 pF (Typ.)		5	± 0.2		20		○				
TLP3275		SSOP4 • C_{OFF} : 12 pF (Typ.)		1.5	± 0.3	50	○						

1-Form-A: 4 pin SO6 package

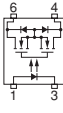
Part Number	Pin Configuration	Features	Trigger LED Current I_{FT} max (mA)	On-State Resistance		On-state Current I_{ON} max (A)	Off-state Voltage V_{OFF} (V)	BVs @1min. (Vrms)	Safety Standards ⁽¹⁾				
				R_{ON} max (Ω)	@ I_F (mA)				UL	c-UL	VDE	BSI	CQC
TLP175A		4 pin SO6 • General-purpose • Low trigger current	1	50	2	± 0.1	60	3750	○	○	□		○

1-Form-A: 2.54SOP4 package

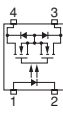
Part Number	Pin Configuration	Features	Trigger LED Current I_{FT} max (mA)	On-State Resistance		On-state Current I_{ON} max (A)	Off-state Voltage V_{OFF} (V)	BVs @1min. (Vrms)	Safety Standards ⁽¹⁾				
				R_{ON} max (Ω)	@ I_F (mA)				UL	c-UL	VDE	BSI	CQC
TLP170A		2.54SOP4 • Low trigger current • General-purpose	1	2	2	± 0.4	60	1500	○	○	○		
TLP170D				8		± 0.2	200		○	○	○		
TLP170G				50		± 0.1	350		○	○	○		
TLP170J				60		± 0.09	600		○	○	○		

Note (1): Please refer to page 43.

1-Form-A: 2.54SOP4 package

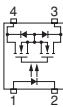
Part Number	Pin Configuration	Features	Trigger LED Current I_{FT} max (mA)	On-State Resistance		On-state Current I_{ON} max (A)	Off-state Voltage V_{OFF} (V)	BVs @1min. (Vrms)	Safety Standards ⁽¹⁾				
				R_{ON} max (Ω)	@ I_F (mA)				UL	c-UL	VDE	BSI	CQC
TLP171A		2.54SOP4 • Ultra-low trigger current	0.2	0.5	2	±0.4	60	1500	○	○	○		
TLP171D					8	±0.2	200		○	○	○		
TLP171GA					35	±0.1	400		△	△	○		
TLP171J					60	±0.07	600		○	○	○		
TLP172A		2.54SOP4 • High output current • General-purpose	3	5	2	±0.4	60		○	○	○		
TLP172G		2.54SOP4 • General-purpose			50	±0.11	350		○	○	○		
TLP174G		2.54SOP4 • Current-limiting function • Limit current 150 to 300 mA			35	±0.12	350		○	○			
TLP174GA		35			±0.12	400	○						
TLP176A		2.54SOP4 • High output current	4	5	2	±0.4	60		○	○	○		
TLP176D		2.54SOP4 • Low On-resistance			8	±0.2	200		○	○	○		
TLP176G		2.54SOP4 • General-purpose			35	±0.12	350		○	○	○	○	
TLP176GA		35			±0.12	400	○			○	○		
TLP179D		2.54SOP4 • C_{OFF} 15 pF (Typ.)	50	±0.05	200	○	○						
TLP3111		2.54SOP4 • Low CR • C_{OFF} 11 pF (Typ.)	3	5	20	±0.1	80		○				
TLP3114		2.54SOP4 • Ultra-low CR: 10 pF Ω • C_{OFF} 5 pF (Typ.)			3	±0.25	40		○	○	○		
TLP3115	2.54SOP4 • Ultra-low CR: 10 pF Ω • C_{OFF} 10 pF (Typ.)	1.5			±0.3	40	○	○	○				
TLP3116	2.54SOP4 • Ultra-low CR: 10 pF Ω • C_{OFF} 1 pF (Typ.)	15			±0.12	40	○	○	○				
TLP3118	2.54SOP4 • Low CR: 40 pF Ω • C_{OFF} 2.5 pF (Typ.), 3.5 pF (max)	3	5	25	±0.04	80	○	○	○				
TLP3119	2.54SOP4 • Low CR: 30 pF Ω • C_{OFF} 6.5 pF (Typ.), 11 pF (max)			8	±0.2	80	○	○	○				

Note (1): Please refer to page 43.

1-Form-A: 2.54SOP4 package

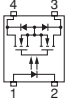
Part Number	Pin Configuration	Features	Trigger LED Current I_{FT} max (mA)	On-State Resistance		On-state Current I_{ON} max (A)	Off-state Voltage V_{OFF} (V)	BV _s @1min. (V _{rms})	Safety Standards ⁽¹⁾				
				R_{ON} max (Ω)	@ I_F (mA)				UL	c-UL	VDE	BSI	CQC
TLP3121		2.54SOP4 • Low CR: 30 pFΩ	4	1.2	5	±0.35	80	1500	○	○	○		
TLP3122		2.54SOP4 • High output current • I_{ON} : 1 A (max) @Ta: up to 50°C		0.7		±1	60		○	○	○		
TLP3123			3	0.13		±1	40		○	○	○		
TLP3127 *		2.54SOP4 • High output current • I_{ON} : 1.7 A (max) @Ta: up to 50°C		0.13		±1.7	60		○	○			
TLP3130		2.54SOP4 • Ultra-low CR: 5 pFΩ • C_{OFF} 1 pF (Typ.)	4	8		±0.16	20		○	○			
TLP3131		2.54SOP4 • Ultra-low CR: 4 pFΩ • C_{OFF} 5 pF (Typ.)		1.2		±0.3	20		○	○			

*: New product

1-Form-A: 2.54SOP6 package

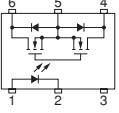
Part Number	Pin Configuration	Features	Trigger LED Current I_{FT} max (mA)	On-State Resistance		On-state Current I_{ON} max (A)	Off-state Voltage V_{OFF} (V)	BV _s @1min. (V _{rms})	Safety Standards ⁽¹⁾				
				R_{ON} max (Ω)	@ I_F (mA)				UL	c-UL	VDE	BSI	CQC
TLP192A		2.54SOP6 • High output current		2	5	±0.4	60	1500	○	○			
TLP192G		2.54SOP6		50		±0.11	350		○	○			
TLP197A		2.54SOP6 • High output current		2		±0.4	60		○	○			
TLP197D		2.54SOP6 • Low On-resistance		8		±0.2	200		○	○			
TLP197G		2.54SOP6	3	35		±0.12	350		○	○	○	○	
TLP197GA		2.54SOP6		35		±0.12	400		○		○		
TLP199D		2.54SOP6 • C_{OFF} 15 pF (Typ.)		50		±0.05	200		○	○			
TLP3100		2.54SOP6 • Low On-resistance • High output current • I_{ON} : 2.5 A (max) @Ta: up to 50°C		0.05		±2.5	20		○	○			
TLP3102		2.54SOP6 • High output current • I_{ON} : 2.5 A (max) @Ta: up to 50°C • C-connection: I_{ON} (DC) = 5.0 A (max)		0.06		±2.5	40		○	○			

Note (1): Please refer to page 43.

1-Form-A: 2.54SOP6 package

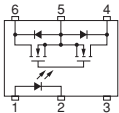
Part Number	Pin Configuration	Features	Trigger LED Current I_{FT} max (mA)	On-State Resistance		On-state Current I_{ON} max (A)	Off-state Voltage V_{OFF} (V)	BVs @1min. (Vrms)	Safety Standards ⁽¹⁾				
				R_{ON} max (Ω)	@ I_F (mA)				UL	c-UL	VDE	BSI	CQC
TLP3103		2.54SOP6 • High output current • I_{ON} : 2.3 A (max) @Ta: up to 50°C • C-connection: I_{ON} (DC) = 4.6 A (max)	3	0.07	5	±2.3	60	1500	○	○			
TLP3105		2.54SOP6 • High output current • I_{ON} : 1.4 A (max) @Ta: up to 50°C • C-connection: I_{ON} (DC) = 2.8 A (max)		0.2		±1.4	100		○	○			
TLP3106 *		2.54SOP6 • General-purpose • High output current • I_{ON} = 4.0 A (max) • C-connection: I_{ON} (DC) = 8.0 A (max)		0.04		±4.0	30		△	△			
TLP3107		2.54SOP6 • High output current • I_{ON} : 3.3 A (max) @Ta: up to 50°C • C-connection: I_{ON} (DC) = 6.6 A (max)		0.06		±3.3	60		○	○			
TLP3109 *		2.54SOP6 • General-purpose • High output current • I_{ON} = 2.0 A (max) • C-connection: I_{ON} (DC) = 4.0 A (max)		0.07		±2.0	100		△	△			
TLP3120		2.54SOP6 • High output current • I_{ON} : 1.25 A (max)		0.15		±1.25	80		○	○			

*: New product

1-Form-A: 2.54SOP8 package

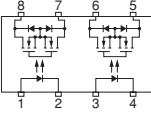
Part Number	Pin Configuration	Features	Trigger LED Current I_{FT} max (mA)	On-State Resistance		On-state Current I_{ON} max (A)	Off-state Voltage V_{OFF} (V)	BVs @1min. (Vrms)	Safety Standards ⁽¹⁾				
				R_{ON} max (Ω)	@ I_F (mA)				UL	c-UL	VDE	BSI	CQC
TLP200D		2.54SOP8 • Dual channel version of the TLP176D	3	8	5	±0.2	200	1500	○				
TLP202A		2.54SOP8 • Dual channel version of the TLP172A		2		±0.4	60		○				
TLP202G		2.54SOP8 • Dual channel version of the TLP172G		50		±0.11	350		○	○			
TLP206A		2.54SOP8 • Dual channel version of the TLP176A		2		±0.4	60		○				
TLP206G		2.54SOP8 • Dual channel version of the TLP176G		35		±0.12	350		○		○	○	
TLP206GA		2.54SOP8 • Dual channel version of the TLP176GA		35		±0.12	400		○		○	○	
TLP209D		2.54SOP8 • Dual channel version of the TLP179D		50		±0.05	200		○				

Note (1): Please refer to page 43

1-Form-A: 2.54SOP8 package

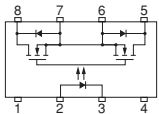
Part Number	Pin Configuration	Features	Trigger LED Current I_{FT} max (mA)	On-State Resistance		On-state Current I_{ON} max (A)	Off-state Voltage V_{OFF} (V)	BVs @1min. (Vrms)	Safety Standards ⁽¹⁾					
				R_{ON} max (Ω)	@ I_F (mA)				UL	c-UL	VDE	BSI	CQC	
TLP3125		2.54SOP8 • Low On-resistance	3	4	5	± 0.2	400	1500	○	○				

1-Form-A: DIP4 package

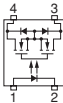
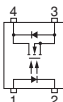
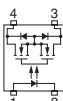
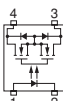
Part Number	Pin Configuration	Features	Trigger LED Current I_{FT} max (mA)	On-State Resistance		On-state Current I_{ON} max (A)	Off-state Voltage V_{OFF} (V)	BVs @1min. (Vrms)	Safety Standards ⁽¹⁾				
				R_{ON} max (Ω)	@ I_F (mA)				UL	c-UL	VDE	BSI	CQC
TLP221A TLP221AF		DIP4 • Reinforced insulation • General-purpose	2	0.15	5	± 2.0	40	2500	○	○	○	○	○
TLP222A		DIP4 • High output current • General-purpose	2	± 0.5		60	○		○				
TLP222D		DIP4 • High output current • General-purpose	8	± 0.3		200	○		○				
TLP222G		DIP4 • General-purpose	50	± 0.12		350	○		○		○		
TLP224G		DIP4 • Current-limiting function • Limit current 150 to 300 mA	35	± 0.12		350	○		○		○		
TLP224GA		DIP4 • Current-limiting function • Limit current 150 to 300 mA	35	± 0.12		400							
TLP225A		DIP4 • For DC use only	1.1	0.5	60	○	○						
TLP227A		DIP4 • General-purpose	3	2	± 0.5	60	○	○					
TLP227G		DIP4 • General-purpose	35	± 0.12	350	○	○	○	○				
TLP227GA		DIP4 • General-purpose	35	± 0.12	400	○							
TLP228G		DIP4 • High EMI immunity • General-purpose	50	± 0.12	350	○	○		○				
TLP240A TLP240AF			DIP4 • Reinforced insulation • General-purpose	2	± 0.5	60	○	○	○	△	○		
TLP240D TLP240DF				8	± 0.25	200	○	○	○	△	○		
TLP240G TLP240GF	50			± 0.1	350	○	○	○	△	○			
TLP240GA TLP240GAF	35			± 0.12	400	○	○	○	△	○			
TLP240J TLP240JF	60			± 0.09	600	○	○	○	△	○			
TLP241A TLP241AF	0.2			± 2.0	40	○	○	○	△				

Note (1): Please refer to page 43.

*: New product **: Under development

1-Form-A: DIP4 package

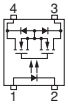
Part Number	Pin Configuration	Features	Trigger LED Current I_{FT} max (mA)	On-State Resistance		On-state Current I_{ON} max (A)	Off-state Voltage V_{OFF} (V)	BVs @1min. (Vrms)	Safety Standards ⁽¹⁾					
				R_{ON} max (Ω)	@ I_F (mA)				UL	c-UL	VDE	BSI	CQC	
TLP3553		DIP4 • High output current • I_{ON} : 3.0 A (max) @ $T_a = 25^\circ\text{C}$	3	0.08	5	± 3	20	2500	○	○				
TLP3554		DIP4 • High output current • I_{ON} : 2.5 A (max) @ $T_a = 25^\circ\text{C}$		0.15		± 2.5	40		○	○				
TLP3555		DIP4 • High output current • I_{ON} : 2.0 A (max) @ $T_a = 25^\circ\text{C}$		0.2		± 2	60		○	○				
TLP3556		DIP4 • High output current • I_{ON} : 1.0 A (max) @ $T_a = 25^\circ\text{C}$		0.7		± 1	100		○	○				

1-Form-A: DIP6 package

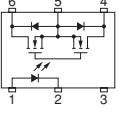
Part Number	Pin Configuration	Features	Trigger LED Current I_{FT} max (mA)	On-State Resistance		On-state Current I_{ON} max (A)	Off-state Voltage V_{OFF} (V)	BVs @1min. (Vrms)	Safety Standards ⁽¹⁾					
				R_{ON} max (Ω)	@ I_F (mA)				UL	c-UL	VDE	BSI	CQC	
TLP592A		DIP6 • High output current	3	2	5	± 0.5	60	2500	○					
TLP592G		DIP6 • General-purpose		50		± 0.12	350		○					
TLP597A		DIP6 • High output current		2		± 0.5	60		○					
TLP597G		DIP6 • General-purpose		35		± 0.12	350		○		○	○		
TLP597GA		DIP6 • General-purpose		35		± 0.12	400		○					
TLP598AA		DIP6 • High output current		2		± 0.5	60		○					
TLP598GA		DIP6 • Low On-resistance		12		± 0.15	400		○					
TLP797GA TLP797GAF		DIP6 • High isolation voltage		35		5	± 0.12		400	○	○	○	Δ	
TLP797J TLP797JF		DIP6 • High isolation voltage	5	45	10	± 0.1	600	5000	○	○	○	Δ		
TLP798GA		DIP6 • High isolation voltage • Low On-resistance	12	5	± 0.15	400	○	○	Δ	Δ				
TLP3542		5 pin DIP6 (cut) • Low On-resistance • High output current • I_{ON} : 2.5 A (max) @ $T_a = 25^\circ\text{C}$	3	0.1	10	± 2.5	60	2500	○	○				
TLP3543		DIP6 • High output current • I_{ON} : 4.0 A (max) @ $T_a = 25^\circ\text{C}$		0.05	± 4	20	○		○					
TLP3544		DIP6 • High output current • I_{ON} : 3.5 A (max) @ $T_a = 25^\circ\text{C}$		0.06	5	± 3.5	40		○	○				
TLP3545		DIP6 • High output current • I_{ON} : 3.0 A (max) @ $T_a = 25^\circ\text{C}$		0.07	± 3	60	○		○					

Note (1): Please refer to page 43.

1-Form-A: DIP6 package

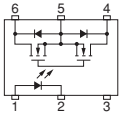
Part Number	Pin Configuration	Features	Trigger LED Current I_{FT} max (mA)	On-State Resistance		On-state Current I_{ON} max (A)	Off-state Voltage V_{OFF} (V)	BVs @1min. (Vrms)	Safety Standards ⁽¹⁾						
				R_{ON} max (Ω)	@ I_F (mA)				UL	c-UL	VDE	BSI	CQC		
TLP3546		DIP6 • High output current • I_{ON} : 2.0 A (max) @ $T_a = 25^\circ\text{C}$	3	0.2	5	± 2	100	2500	○	○					

2-Form-A

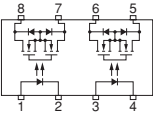
Part Number	Pin Configuration	Features	Trigger LED Current I_{FT} max (mA)	On-State Resistance		On-state Current I_{ON} max (A)	Off-state Voltage V_{OFF} (V)	BVs @1min. (Vrms)	Safety Standards ⁽¹⁾						
				R_{ON} max (Ω)	@ I_F (mA)				UL	c-UL	VDE	BSI	CQC		
TLP222A-2		DIP8 • Dual channel version of the TLP222A	3	2	5	± 0.5	60	2500	○	○					
TLP222G-2		DIP8 • Dual channel version of the TLP222G		50		350	○		○		○				
TLP224G-2		DIP8 • Dual channel version of the TLP224G		35		350	○		○		○				
TLP224GA-2		DIP8 • Dual channel version of the TLP224GA • Current-limiting function • Limit current: 150 to 300 mA		35		400	○		○						
TLP227A-2		DIP8 • Dual channel version of the TLP227A		2		60	○		○						
TLP227G-2		DIP8 • Dual channel version of the TLP227G		35		350	○		○	○	○				
TLP227GA-2		DIP8 • Dual channel version of the TLP227GA		35		400	○								
TLP228G-2		DIP8 • Dual channel version of the TLP228G		50		350	○		○		○				

1-Form-B

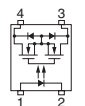
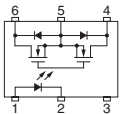
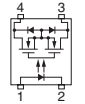
Part Number	Pin Configuration	Features	Trigger LED Current I_{FT} max (mA)	On-State Resistance		On-state Current I_{ON} max (A)	Off-state Voltage V_{OFF} (V)	BVs @1min. (Vrms)	Safety Standards ⁽¹⁾					
				R_{ON} max (Ω)	@ I_F (mA)				UL	c-UL	VDE	BSI	CQC	
TLP4176G		2.54SOP4 • General-purpose	3	25	0	± 0.12	350	1500	○					
TLP4197G		2.54SOP4 • General-purpose							○					
TLP4227G		DIP4 • General-purpose				± 0.15		2500	○					

Note (1): Please refer to page 43.

1-Form-B

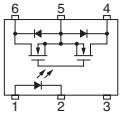
Part Number	Pin Configuration	Features	Trigger LED Current I_{FT} max (mA)	On-State Resistance		On-state Current I_{ON} max (A)	Off-state Voltage V_{OFF} (V)	BVs @1min. (Vrms)	Safety Standards ⁽¹⁾					
				R_{ON} max (Ω)	@ I_F (mA)				UL	c-UL	VDE	BSI	CQC	
TLP4597G		DIP6 • General-purpose	3	25	0	± 0.15	350	2500	○					

2-Form-B

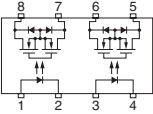
Part Number	Pin Configuration	Features	Trigger LED Current I_{FT} max (mA)	On-State Resistance		On-state Current I_{ON} max (A)	Off-state Voltage V_{OFF} (V)	BVs @1min. (Vrms)	Safety Standards ⁽¹⁾				
				R_{ON} max (Ω)	@ I_F (mA)				UL	c-UL	VDE	BSI	CQC
TLP4206G		2.54SOP8 • Dual channel version of the TLP4176G	3	25	0	± 0.12	350	1500	○				
TLP4227G-2		DIP8 • Dual channel version of the TLP4227G				± 0.15		2500	○				

1-FormA, 1-Form-B

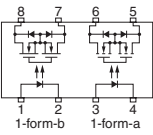
Part Number	Pin Configuration	Features	Trigger LED Current I_{FT} max (mA)	On-State Resistance		On-state Current I_{ON} max (A)	Off-state Voltage V_{OFF} (V)	BVs @1min. (Vrms)	Safety Standards ⁽¹⁾				
				R_{ON} max (Ω)	@ I_F (mA)				UL	c-UL	VDE	BSI	CQC
TLP4006G		DIP8 • General-purpose	3	25	0	1-Form-A: 5 1-Form-B: 0	350	2500					
TLP4026G		2.54SOP4 • General-purpose						1500	○				

Note (1): Please refer to page 43.

Reference

Note (1): Certified to safety standards. For details on certification status, contact your Toshiba sales representative.

UL/c-UL/CQC: ○: Approved △: Approval pending as of April 2015

BSI: ○: Approved (supplementary, basic insulation or reinforced insulation) △: Approval pending as of April 2015

BSI: EN 60065 / EN 60950-1-certified

VDE: ○: Approved (EN 60747-5-certified) □: Approved (EN 60747-5-5 / EN 60065 / EN 60950-1-certified)

△: Approval pending as of April 2015

Specify VDE-certified devices with option V4 or D4

UL: Underwriters Laboratories (UL) is a safety consulting and certification company.

c-UL: c-UL Mark is the UL Mark for Canada.

VDE: Verband der Elektrotechnik Elektronik Informationstechnik e.V.

BSI: British Standards Institution

CQC: China Quality Certification center

(2): The products with the ranks Y and BL are limited in production. For details, please contact your local Toshiba sales representative.

(3): For details of the devices, please contact your local Toshiba sales representative.

(4): This product is for Japan.

Package Dimensions

Unit: mm

► 4 pin DIP type

DIP4 (standard)	DIP4 (LF1)	DIP4 (LF2) / DIP4 (F type)
DIP4 (LF4) / (LF7)	DIP4 (LF5) / (LF6)	

► 6 pin DIP type

DIP6 (standard)	DIP6 (LF1)	DIP6 (LF2) / DIP6 (F type)
DIP6 (LF4) / (LF7)	DIP6 (LF5) / (LF6)	

* All dimensions are for reference only unless tolerance is given.

► 8 pin DIP type

DIP8 (standard)	DIP8 (LF1)	DIP8 (LF2) / DIP8 (F type)

DIP8 (LF4) / (LF7)	DIP8 (LF5) / (LF6)

► Other DIP type / SDIP type

5 pin DIP6	5 pin DIP6 (LF2)	5 pin DIP6 (cut)
DIP16	SDIP6	SDIP6 (F type)

* All dimensions are for reference only unless tolerance is given.

► MFC (Mini Flat Coupler) type

4 pin MFSOP6	4 pin MFSOP6 (No.5cut)	5 pin MFSOP6

► 2.54 SOP type

2.54 SOP4	2.54 SOP6	2.54 SOP8

► SOP/SSOP/USOP/VSON type

SOP4	SOP16	SSOP4

* All dimensions are for reference only unless tolerance is given.

► SO type		
SO4	4 pin SO6	5 pin SO6
SO8	SO16	
► SOL type		
4 pin SO6L	SO6L	SO8L
SO16L		

* All dimensions are for reference only unless tolerance is given.

Lead Form Options for DIP Packages

The DIP4, DIP6, DIP8 and DIP16 packages offer three surface-mount lead form options and a wide-spaced lead form option. The electrical characteristics are identical, regardless of these options.

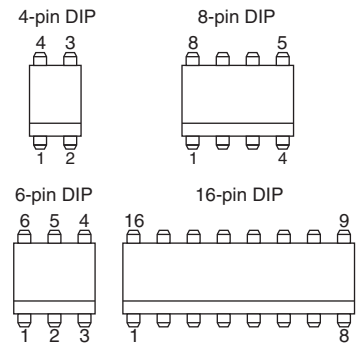

Lead Form	Surface-Mount			Wide-Spaced																																		
Appearance																																						
Lead Form Code	(LF1)	(LF4), (LF7) ⁽²⁾	(LF5), (LF6) ⁽²⁾	(LF2), (F type)																																		
Carrier Tape Code	(TP1)	(TP4), (TP7) ⁽²⁾	(TP5), (TP6) ⁽²⁾	Not available ⁽¹⁾																																		
Package Outline	<table border="1"> <caption>Dimensions (mm)</caption> <thead> <tr> <th rowspan="2">Dimension</th> <th colspan="2">Version (LF1)</th> <th colspan="2">Version (LF4)</th> <th colspan="2">Version (LF5)</th> </tr> <tr> <th>min</th> <th>max</th> <th>min</th> <th>max</th> <th>min</th> <th>max</th> </tr> </thead> <tbody> <tr> <td>A</td> <td>—</td> <td>10.0</td> <td>—</td> <td>12.0</td> <td>—</td> <td>10.0</td> </tr> <tr> <td>B</td> <td colspan="2">(0.35 typ.)</td> <td colspan="2">(0.25 typ.)</td> <td>—</td> <td>0.2</td> </tr> <tr> <td>C</td> <td>6.4</td> <td>—</td> <td>8.0</td> <td>—</td> <td>6.4</td> <td>—</td> </tr> </tbody> </table> <p>∅ All other package dimensions are the same as for each standard package specification.</p>			Dimension	Version (LF1)		Version (LF4)		Version (LF5)		min	max	min	max	min	max	A	—	10.0	—	12.0	—	10.0	B	(0.35 typ.)		(0.25 typ.)		—	0.2	C	6.4	—	8.0	—	6.4	—	
Dimension	Version (LF1)		Version (LF4)		Version (LF5)																																	
	min	max	min	max	min	max																																
A	—	10.0	—	12.0	—	10.0																																
B	(0.35 typ.)		(0.25 typ.)		—	0.2																																
C	6.4	—	8.0	—	6.4	—																																

(1) Tape-and-reel packing is not available with (LF2).
 (2) The package dimensions and lead form options of the TLP785 differ from those shown above. See the TLP785 datasheet.
 (3) Standard part names should be used when applying for safety standard approval.

Example Land Patterns

Unit: mm

DIP (surface-mount lead form) ⁽¹⁾			SDIP	
DIP (LF1) / (LF5)	DIP (LF4) / (F type)		SDIP6	SDIP6 (F type)
MFC		2.54 SOP		
4pin MFSOP6	5pin MFSOP6	2.54SOP4	2.54SOP6	2.54SOP8
SOP/SSOP/USOP/VSON				
SOP4	SOP16	SSOP4	USOP4	VSON4
SO				
SO4	4pin SO6	5pin SO6	SO8	SO16
SOL				
4pin SO6L	SO6L	SO16L		

* The PCB land Pattern dimensions shown above are for reference only and should be determined empirically.
 (1) For the example land patterns for the TLP785, see their respective datasheets.

Rank Marking

Transistor-output photocouplers are ranked according to their CTR (Current Transfer Ratio) ranges, whereas thyristor-output and triac-output photocouplers are ranked according to their maximum I_{FT} value. The following gives the rank classifications and rank marks printed on packages. Note that the rank classifications differ from product to product. For details, please refer to the relevant technical datasheets.

CTR Rank Name and Rank Marking (for Transistor-output)

Available CTR Rank Selection (○ Available, △ Contact your nearest Toshiba sales representative)

Input Type	Rank Name	None		Y	YH	GR	GRL	GRH	GB		BL	BLL	LA	LGB	
	CTR Rank Marking	Blank		YE	Y+	GR	G	G+	GB		BL	B	LA (*)	LB (*)	
	CTR	max	50	50	50	75	100	100	150	100	100	200	200	50	100
	min	400	600	150	150	300	200	300	400	600	600	400	600	600	600
DC Input	TLP183		○	○	○	○	○	○		○	○	○			
	TLP185(SE)		○	○	○	○	○	○		○	○	○			
	TLP188		○							○					
	TLP291-4	○							○						
	TLP291(SE)		○	○	○	○	○	○		○	○	○			
	TLP293		○	○	○	○	○	○		○	○	○			
	TLP293-4		○							○			○	○	
	TLP383		○	○	○	○	○	○		○	○	○			
	TLP385		○	○	○	○	○	○		○	○	○			
	TLP731		○	△			○			○	△				
	TLP732		○	△			○			○	△				
	TLP785/785F		○	○	○	○	○	○		○	○	○			
TLP2301		○							○						
AC Input	TLP182		○	○		○				○	○				
	TLP184(SE)		○	○		○				○	○				
	TLP290-4	○							○						
	TLP290(SE)		○	○		○				○	○				
	TLP292		○	○		○				○	○				
	TLP292-4												○	○	

(*): The LA and LB rank are made CTR rank of the low input current condition.

Marking Examples

(a) DIP4 Package (TLP785)

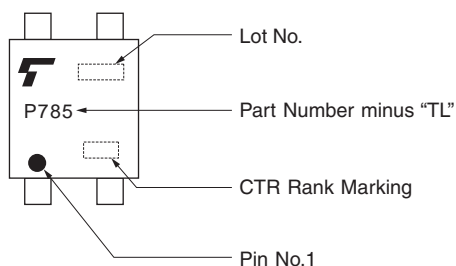

(b) SO4 Package (TLP291)

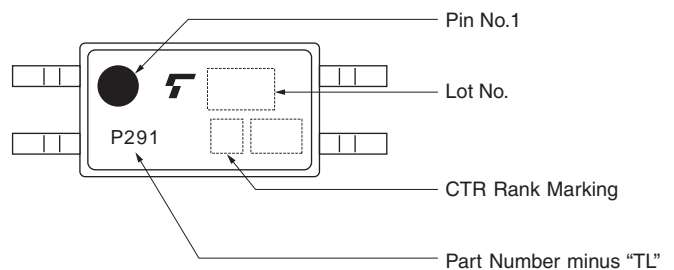

LED Trigger Current (I_{FT}) Rank Name and Rank Marking (for Triac-output)

Off-state Output Terminal Voltage V _{DRM}	Part Number	Trigger LED Current I _{FT} (mA) max				
		Rank Name	None	IFT7	IFT5	IFT2
		I _{FT} Rank Marking	Blank	T7	T5	T2
400 V	TLP560G	10	7	5	—	
	TLP561G	10	7	5	—	
	TLP665G(S) / TLP665GF(S)	10	7	—	—	
	TLP666G(S) / TLP666GF(S)	10	7	—	—	
600 V	TLP265J	10	7	—	—	
	TLP266J	10	7	—	—	
	TLP267J	3	—	—	2	
	TLP268J	3	—	—	2	
	TLP360J / TLP360JF	10	7	—	—	
	TLP361J / TLP361JF	10	7	—	—	
	TLP560	10	7	—	—	
	TLP561	10	7	—	—	
	TLP665J(S) / TLP665JF(S)	10	7	—	—	
	TLP665L	10	7	—	—	
800 V	TLP666J(S) / TLP666JF(S)	10	7	—	—	
	TLP669L(S) / TLP669LF(S)	10	—	5	—	

Marking Examples

(a) 4 pin SO6 Package (TLP265J)

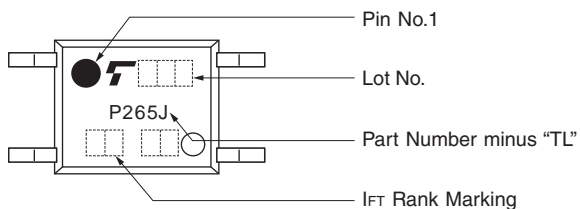

(b) 5 pin DIP6 Package (TLP665L)

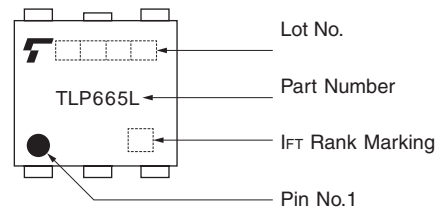

Note:

- Specify both the part number and a rank in this format when ordering.
Examples: TLP183 (GB), TLP560G (T7)
- For safety standard certification, however, specify the part number alone.
Examples: $\frac{\text{Part number}}{\text{TLP183 (GB)}} \rightarrow \frac{\text{Use this part number}}{\text{TLP183}}$

Magazine Packing Specification

Unit: mm

DIP type		Standard				Lead Forming LF1, LF2 / F type, LF4 / LF7, LF5 / LF6				
Magazine	Dimensions									
	Pin Count	4 pin	6 pin	8 pin	16 pin	4 pin	6 pin	8 pin	16 pin	
	Quantities per Magazine	100 pcs	50 pcs	50 pcs	25 pcs	100 pcs	50 pcs	50 pcs	25 pcs	
Carton	Number of Magazines	4		20		60		40		
	Carton Dimensions	A	50 mm	67 mm	123 mm	60 mm	135 mm			
		B	12 mm	51 mm	76 mm	13 mm	58 mm			
		C	531 mm	559 mm	568 mm	531 mm	568 mm			
Label Position	Y		Y		X		Y		X	

Unit: mm

SDIP type		SDIP6	
Magazine	Dimensions		
	Quantities per Magazine	100 pcs	
Carton	Number of Magazines	40	
	Carton Dimensions	A	135 mm
		B	58 mm
		C	568 mm
Label Position	X		

Unit: mm

MFC type		MFSOP6			
Magazine	Dimensions				
	Quantities per Magazine	150 pcs			
Carton	Number of Magazines	4	24	40	
	Carton Dimensions	A	29 mm	77 mm	67 mm
		B	13 mm	31 mm	55 mm
		C	563 mm	586 mm	586 mm
Label Position	Y	Y	X		

Unit: mm

2.54 SOP type		2.54 SOP			
Magazine	Dimensions				
	Pin Count	4 (2.54 SOP4)	6 (2.54 SOP6)	8 (2.54 SOP8)	
	Quantities per Magazine	100 pcs	75 pcs	50 pcs	
Carton	Number of Magazines	4	24	40	
	Carton Dimensions	A	29 mm	77 mm	67 mm
		B	13 mm	31 mm	55 mm
		C	563 mm	586 mm	586 mm
Label Position	Y	Y	X		

Unit: mm

SOP type		SOP			
Magazine	Dimensions				
	Pin Count	4 (SOP4)	16 (SOP16)		
	Quantities per Magazine	150 pcs	50 pcs		
Carton	Number of Magazines	4	24	40	
	Carton Dimensions	A	29 mm	77 mm	67 mm
		B	13 mm	31 mm	55 mm
		C	563 mm	586 mm	586 mm
Label Position	Y	Y	X		

Unit: mm

SO type		SO4	SO6	SO8	SO16	
Magazine	Dimensions					
	Quantities per Magazine	175 pcs	125 pcs	100 pcs	50 pcs	
Carton	Number of Magazines	40	40	24	40	
	Carton Dimensions	A	71 mm	70 mm	75 mm	61 mm
		B	32 mm	55 mm	29 mm	56 mm
		C	584 mm	585 mm	579 mm	586 mm
Label Position	X	X	X	X		

Unit: mm

SOL type		SOL	
Magazine	Dimensions		
	Pin Count	6 (SO6L)	16 (SO16L)
	Quantities per Magazine	125 pcs	50 pcs
Carton	Number of Magazines	20	
	Carton Dimensions	A	70 mm
		B	55 mm
		C	585 mm
Label Position	X		

* All dimensions are typical values.

Photocouplers are stored in magazines, and packed into cartons. An overview of how devices are packed is shown below.

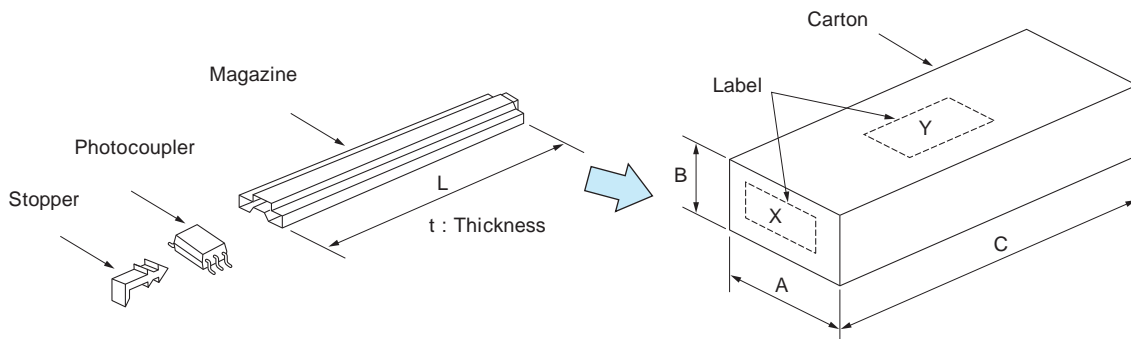

Tape-and-Reel Specification

Tape Dimensions

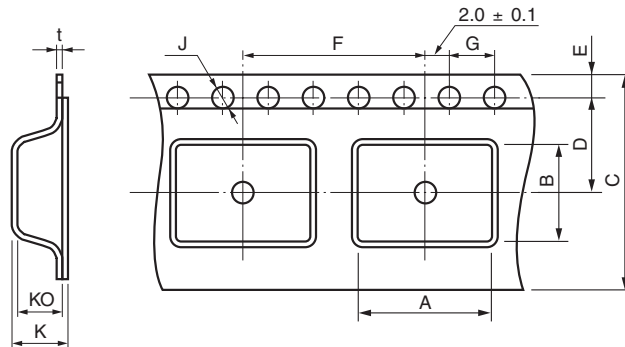

Unit: mm

Package	DIP (LF1) (LF5)	DIP (LF4)	SDIP6	SDIP6 F type	MFSOP6	2.54SOP4	2.54SOP6	2.54SOP8	SOP4	SOP16	SSOP4	USOP4	VSON4	SO4	SO6	SO8	SO16	SO6L	SO16L		
Taping	(TP1) (TP5)	(TP4)	(TP)	(TP)	(TPL) (TPR)	(TP)	(TP)	(TP)	(TP)	(TP)	(TP)	(TP15)	(TP)	(TP)	(TPL) (TPR)	(TP)	(TP)	(TP)	(TP)		
Symbol	A	10.4±0.1	12.3±0.1	10.4±0.1	12.3±0.1	4.2±0.1	4.3±0.1	7.5±0.1	3.1±0.1	7.5±0.1	2.35±0.2	2.6±0.1	1.6±0.1	3.1±0.1	4.0±0.1	6.5±0.1	7.5±0.1	10.4±0.1			
	B	(*1)	(*1)	5.1±0.1		7.6±0.1	7.5±0.1	6.7±0.1	10.5±0.1	7.5±0.1	10.5±0.1	4.5±0.1	3.55±0.1	3.0±0.1	7.5±0.1	7.6±0.1	5.6±0.1	10.5±0.1	4.24±0.1	10.7±0.1	
	C	16.3±0.3				12.0±0.3	12.0±0.3	16.0±0.3		12.0±0.3	16.0±0.3	12.0±0.3	12.0±0.3	8.0±0.3	12.0±0.3		16.0±0.3	16.0±0.3			
	D	7.5±0.1				5.5±0.1	5.5±0.1	7.5±0.1		5.5±0.1	7.5±0.1	5.5±0.1	5.5±0.1	3.5±0.1	5.5±0.1		7.5±0.1	7.5±0.1			
	E	1.75±0.1				1.75±0.1	1.75±0.1			1.75±0.1			1.75±0.1			1.75±0.1					
	F	12.0±0.1	16.0±0.1	12.0±0.1	16.0±0.1	8.0±0.1	8.0±0.1	12.0±0.1		8.0±0.1	12.0±0.1	4.0±0.1	4.0±0.1	4.0±0.1	8.0±0.1		12.0±0.1	12.0±0.1			
	G	4.0±0.1				4.0±0.1	4.0±0.1			4.0±0.1			4.0±0.1			4.0±0.1					
	J	1.5 ^{+0.1} ₋₀				1.5 ^{+0.1} ₋₀	1.5 ^{+0.1} ₋₀			1.5 ^{+0.1} ₋₀			1.5 ^{+0.1} ₋₀			1.5 ^{+0.1} ₋₀					
	K	4.55±0.2				3.15±0.2	2.6±0.2	2.5±0.2	2.4±0.2	2.5±0.2	2.4±0.2	2.4±0.2	2.4±0.2	(2.0±0.1)	(1.8±0.1)	3.15±0.2	2.9±0.2	3.4±0.2	2.6±0.2	(2.7±0.1)	
	K0	4.1±0.1				2.7±0.1	2.4±0.1	2.3±0.1	2.2±0.1	2.3±0.1	2.2±0.1	2.1±0.1	1.95±0.1	1.5±0.1	2.3±0.1	2.6±0.1	3.1±0.1	2.2±0.1	2.4±0.1		
	t	0.4±0.05				0.3±0.05			0.3±0.05			0.3±0.1			0.2±0.05	0.3±0.05			0.3±0.05		

(*1): Typical devices

DIP4	5.1±0.1
DIP6 (short package)	7.6±0.1
DIP8	10.1±0.1 (TP4) is not available.

Reel Dimensions

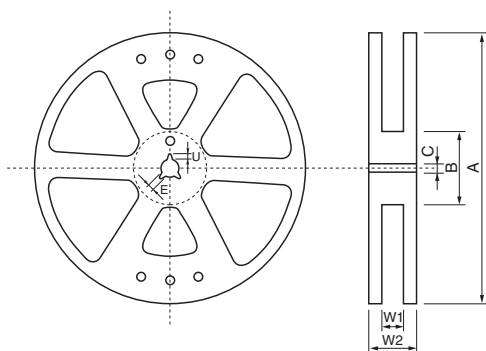

Unit: mm

Package	DIP (LF1) (LF5)	DIP (LF4)	SDIP6	SDIP6 F type	MFSOP6	2.54SOP4	2.54SOP6	2.54SOP8	SOP4	SOP16	SSOP4	USOP4	VSON4	SO4	SO6	SO8	SO16	SO6L	SO16L	
Taping	(TP1) (TP5)	(TP4)	(TP)	(TP)	(TPL) (TPR)	(TP)	(TP)	(TP)	(TP)	(TP)	(TP15)	(TP15)	(TP)	(TP)	(TPL) (TPR)	(TP)	(TP)	(TP)	(TP)	
Symbol	A	ø380±2			ø380±2	ø330±2			ø330±2		180 ⁺⁰ ₋₄	180 ⁺⁰ ₋₄	ø180±3	ø330±2	ø380±2	ø330±2		ø330±2		
	B	ø80±1			ø80±1	ø80±1			ø80±1		ø60	ø60	ø60±1	ø80±1	ø80±1	ø80±1		ø100±1		
	C	ø13±0.5			ø13±0.5	ø13±0.5			ø13±0.5		ø13	ø13±0.5		ø13±0.5			ø13±0.5			
	E	2.0±0.5			2.0±0.5	2.0±0.5			2.0±0.5			2.0±0.5		2.0±0.5			2.0±0.5			
	U	4.0±0.5			4.0±0.5	4.0±0.5			4.0±0.5			4.0±0.5		4.0±0.5			4.0±0.5			
	W1	17.5±0.5			13.5±0.5	13.5±0.5	17.5±0.5		13.5±0.5	17.5±0.5	13.0±0.3	13.0±0.3	9.0±0.3	13.5±0.5		17.5±0.5		17.4±1.0		
	W2	21.5±1.0			17.5±1.0	17.5±1.0	21.5±1.0		17.5±1.0	21.5±1.0	15.4±1.0	15.4±1.0	11.4±1.0	17.5±1.0		21.5±1.0		21.4±1.0		

■ Device Orientation on Tape

Photocouplers are oriented in cavity, as shown below.

Package Type	Tape Option	Packing Quantity (pcs/reel)	Device Orientation on Tape
MFSO6	TPR	3,000	
SO6		3,000	
MFSO6	TPL	3,000	
SO6		3,000	
2.54SOP4	TP	2,500	
SOP4		2,500	
VSON4		3,000	
SO4		2,500	
SSOP4	TP15	1,500	
USOP4			
SDIP6	TP	1,500	
SDIP6 (F type)		1,000	
2.54SOP6		2,500	
2.54SOP8		2,500	
SOP16		2,500	
SO8		2,500	
SO16		2,000	
SO6L		1,500	
SO16L		1,500	
DIP (LF1)	TP1	1,500	
DIP (LF4)	TP4	1,000	
DIP (LF5)	TP5	1,500	

■ Empty Device Recesses

Item	Specification	Note
Consecutive empty cavities	Zero	Any 40-mm portion of tape except leader and trailer
Non-consecutive empty cavities	0.2% max/reel (*2)	Except leader and trailer

(*2): 6pcs max/reel for DIP and SDIP packages

■ Packing Boxes

Either one reel or ten reels of photocoupler are packed in a shipping carton.

■ Label Indication

The carton bears a label indicating the part number, the symbol representing classification of standard, the quantity, the lot number and Toshiba company name.

Board Assembly Considerations

1. Soldering

The profile below shows only the typical temperature profile and conditions, which might not apply to all Toshiba photocouplers. Temperature profiles and conditions may differ from product to product. Refer to the relevant technical datasheets when mounting a device. When using a soldering iron or medium infrared ray / hot air reflow, avoid a rise in device temperature as much as possible by observing the following conditions.

1.1) Using a soldering iron

- Solder once within 10 seconds for a lead temperature of up to 260°C.
- Solder once within 3 seconds for a lead temperature of up to 350°C.

1.2) Using medium infrared ray/hot air reflow

- Complete the infrared ray/hot air reflow process at once within 30 seconds at a package surface temperature between 210°C and 240°C.
- Example of temperature profile of lead (Pb)-free solder

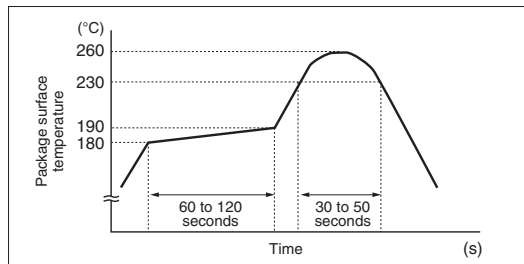

Example of temperature profile of lead (Pb)-free solder

- Temperature Profile of JEDEC Pb-Free Solder (For Reference Only)

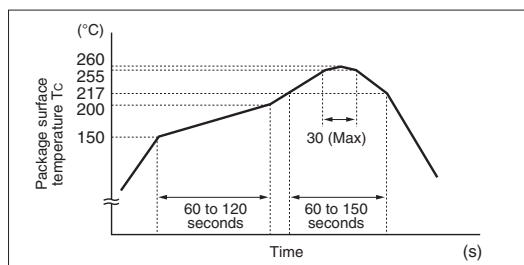

Temperature profile of JEDEC Pb-free solder (for reference only)

- Precautions for heating

Keeping packages at high temperature for a long period of time can degrade the quality and reliability of devices. Soldering time has to be kept as short as possible to avoid a rise in package temperature. When using a halogen lamp or infrared heater, avoid direct irradiation of packages, since this may cause a rise in package temperature.

1.3) Dip soldering (flow soldering)

The thermal shock of dip soldering increases thermal stress on devices. To avoid stress, the use of a soldering iron or medium infrared ray/hot air reflow is recommended. If you want to use dip soldering, contact your nearest Toshiba sales representative.

2. Flux Cleaning

- When cleaning circuit boards to remove flux, make sure that no residual reactive ions such as sodium (Na+) or chloride (Cl-) ions remain. Note that organic solvents react with water to generate hydrogen chloride and other corrosive gases, which can degrade device performance.
- Washing devices with water will not cause any problems. However, make sure that no reactive ions such as sodium (Na+) or chloride (Cl-) ions are left as residue. Also, be sure to dry devices sufficiently after washing.
- Do not rub device markings with a brush or with your hand during cleaning or while the devices are still wet from the cleaning agent. Doing so can rub off the markings.
- Dip cleaning, shower cleaning and steam cleaning processes all involve the chemical action of a solvent. Use only recommended solvents for these cleaning methods. When immersing devices in a solvent or steam bath, make sure that the temperature of the liquid is 50°C or below and that the circuit board is removed from the bath within one minute.
- If a device package allows ultrasonic cleaning, keep the duration of ultrasonic cleaning as short as possible, since long hours of ultrasonic cleaning degrade the adhesion between the mold resin and the frame material.

■ The following ultrasonic cleaning conditions are recommended.

Frequency: 27 kHz to 29 kHz

Ultrasonic output power: 300 W or less (0.25 W/cm² or less)

Cleaning time: 30 seconds or less

Suspend the circuit board in the solvent bath during ultrasonic cleaning in such a way that the ultrasonic vibrator does not come into direct contact with the circuit board or the device.

Conventional cleaning solvents that contain freon are not recommended due to its adverse effects on the earth's ozone layer. Alternative freon-free products are available on the market.

Contact Toshiba or a Toshiba distributor regarding cleaning conditions and other relevant information for each product type.

Projected Operating Life Based on LED Light Output Degradation

Toshiba photocouplers use one of four types of LEDs and a projection of the operating life has been made for each LED. The table on page 52 shows the types of LED used in photocouplers and the figures on pages 58 to 60 show projections of long-term light output performance and operating life. Note that these operating life data are estimates extrapolated from long-term light output degradation over a single wafer lot and are shown as reference only.

	Projected Operating Life ⁽¹⁾		Photocouplers
	F50% operating life ⁽²⁾	F0.1% operating life ⁽³⁾	
① GaAs LED	1,300,000 h	260,000 h	Mainly for phototransistor output devices and phototriac output devices
② GaAlAs (SH) LED	540,000 h	100,000 h	Mainly for photo-IC couplers
③ GaAlAs (DH) LED	1,000,000 h	200,000 h	Mainly for photorelays (MOSFET output), photovoltaic couplers and photo-IC couplers
④ GaAlAs (MQW) LED	Ask your local Toshiba sales representative.		Mainly for photo-IC couplers

(1) Ta = 40°C, If = 20 mA, failure criteria: degradation rate ΔPo < -50%

(2) Cumulative failure rate 50%: Time period until the projected long-term light output degradation curve of the average light output change (\bar{X}) shown on pages 58 to 60 reaches the failure criteria.

(3) Cumulative failure rate 0.1%: Time period until the projected long-term light output degradation curve of $\bar{X} - 3$ shown on pages 58 to 60 reaches the failure criteria.

The relationship between LED light output degradation and optical coupling characteristics is shown below.

- The relationship between LED light output degradation and current transfer ratio (CTR)/short circuit current (Isc) is 1:1.

$$\frac{\text{CTR (t)}}{\text{CTR (o)}} = \frac{\text{Po (t)}}{\text{Po (o)}}$$

- The relationship between a reciprocal value of LED light output degradation and IFT/IFLH/IFHL/IFH change is 1:1.

$$\frac{\text{IFT (t)}}{\text{IFT (o)}} = \left(\frac{\text{Po (t)}}{\text{Po (o)}} \right)^{-1}$$

LEDs Used in Photocouplers

LED: ① GaAs ② GaAIAs (SH) ③ GaAIAs (DH) ④ GaAIAs (MQW)

Photocouplers	LED	Photocouplers	LED	Photocouplers	LED	Photocouplers	LED	Photorelays	LED
TLP104	④	TLP358	④	TLP708	④	TLP2530	②	TLP170 Series	①
TLP105	④	TLP358H	④	TLP714	④	TLP2531	②	TLP171 Series	④
TLP108	④	TLP360J	①	TLP715	②	TLP2601	②	TLP172 Series	①
TLP109 Series	④	TLP361J	①	TLP716	②	TLP2630	②	TLP174G Series	①
TLP116A	④	TLP363J	①	TLP718	②	TLP2631	②	TLP175A	④
TLP117	④	TLP371	①	TLP719	②	TLP2662	④	TLP176 Series	①
TLP118	④	TLP372	①	TLP731	①	TLP2703	④	TLP179D	①
TLP124	①	TLP373	①	TLP732	①	TLP2766	④	TLP192 Series	①
TLP126	①	TLP385	**	TLP733	①	TLP2767	**	TLP197 Series	①
TLP127	①	TLP512	②	TLP734	①	TLP2768	④	TLP199D	①
TLP130	①	TLP513	②	TLP748J	①	TLP2955	④	TLP200D	①
TLP131	①	TLP523 Series	①	TLP750	②	TLP2958	④	TLP202 Series	①
TLP137	①	TLP525G Series	①	TLP751	②	TLP2962	④	TLP206 Series	①
TLP148G	①	TLP531	①	TLP754	④	TLP3022(S)	①	TLP209D	①
TLP151A	④	TLP532	①	TLP759 Series	②	TLP3023(S)	①	TLP221A	④
TLP152	④	TLP548J	①	TLP762J	①	TLP3042(S)	①	TLP222 Series	①
TLP155 Series	④	TLP549J	①	TLP763J	①	TLP3043	①	TLP224G Series	①
TLP160 Series	①	TLP550	②	TLP785	①	TLP3052	①	TLP225A	①
TLP161 Series	①	TLP551	②	TLP2066	③	TLP3062	①	TLP227 Series	①
TLP163J	①	TLP552	②	TLP2095	④	TLP3063(S)	①	TLP228 Series	①
TLP165J	①	TLP553	②	TLP2098	④	TLP3064	③	TLP240 Series	④
TLP166J	①	TLP554	②	TLP2105	②	TLP3082	①	TLP241A	④
TLP168J	③	TLP555	②	TLP2108	②	TLP3762(S)	①	TLP592 Series	①
TLP173A	①	TLP557	②	TLP2116	②	TLP3782	④	TLP597 Series	①
TLP182	④	TLP558	②	TLP2118E	④	TLP3783	④	TLP598 Series	③
TLP183	④	TLP559 Series	②	TLP2160	④	TLP3902	①	TLP797 Series	①
TLP184(SE)	①	TLP560 Series	①	TLP2161	④	TLP3904	①	TLP798GA	③
TLP185(SE)	①	TLP561 Series	①	TLP2166A	②	TLP3905	④	TLP31xx Series	①
TLP187	④	TLP570	①	TLP2167	**	TLP3906	④	TLP3203	①
TLP188	④	TLP571	①	TLP2168	④	TLP3914	③	TLP321x Series	①
TLP190B	③	TLP572	①	TLP2200	②	TLP3924	③	TLP3220	①
TLP191B	③	TLP590B	③	TLP2301	④	TLP5701	④	TLP3230	①
TLP220 Series	④	TLP591B	③	TLP2309	④	TLP5702	④	TLP3231	①
TLP250H	④	TLP620 Series	①	TLP2310	**	TLP5751	④	TLP3240	③
TLP265J	④	TLP624 Series	①	TLP2345	**	TLP5752	④	TLP3241	③
TLP266J	④	TLP626 Series	①	TLP2348	**	TLP5754	④	TLP3250	③
TLP267J	④	TLP627 Series	①	TLP2355	④	TLPN137	④	TLP3275	①
TLP268J	④	TLP628 Series	①	TLP2358	④	6N135	②	TLP33xx Series	①
TLP280-4	①	TLP630	①	TLP2361	④	6N136	②	TLP34xx Series	④
TLP281-4	①	TLP631	①	TLP2362	④	6N137	②	TLP35xx Series	③
TLP290-4	①	TLP632	①	TLP2366	④	6N138	②	TLP4xxx Series	①
TLP290(SE)	①	TLP651	②	TLP2367	**	6N139	②		
TLP291-4	①	TLP663J	①	TLP2368	④				
TLP291(SE)	①	TLP665 Series	①	TLP2395	④				
TLP292 Series	④	TLP666 Series	①	TLP2398	④				
TLP293 Series	④	TLP668J	③	TLP2403	④				
TLP331	①	TLP669L	④	TLP2404	④				
TLP332	①	TLP700	④	TLP2405	④				
TLP350	②	TLP700A	④	TLP2408	④				
TLP350H	④	TLP700H	④	TLP2409	④				
TLP351	②	TLP701	②	TLP2418	④				
TLP351A	④	TLP701A	④	TLP2451A	④				
TLP351H	④	TLP701H	④	TLP2466	④				
TLP352	④	TLP705A	④	TLP2468	④				

** : Under development

① GaAs LED

Projected Light Output Degradation Data

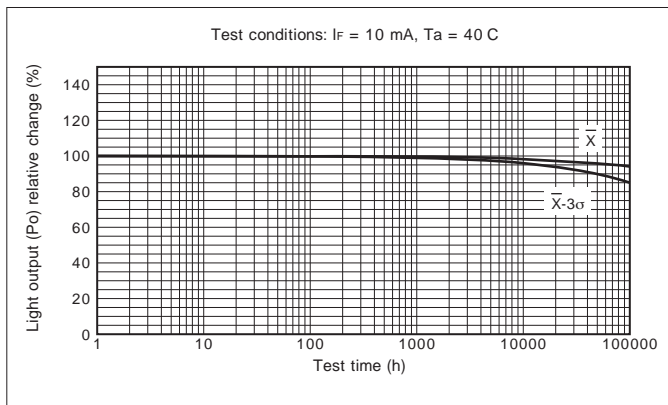
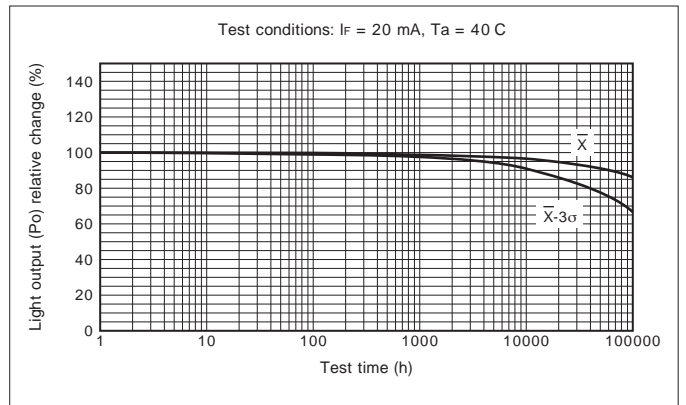
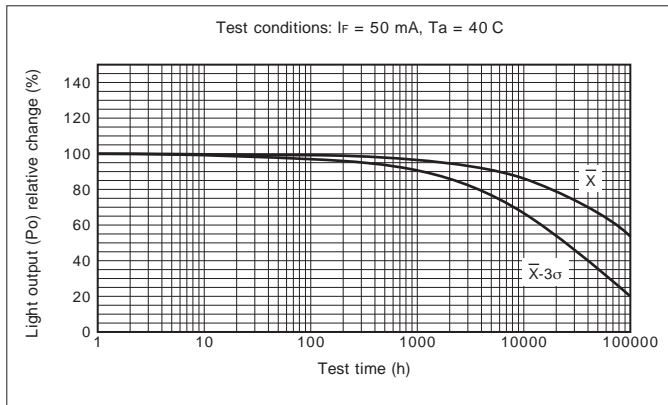

Projected Operating Life Data

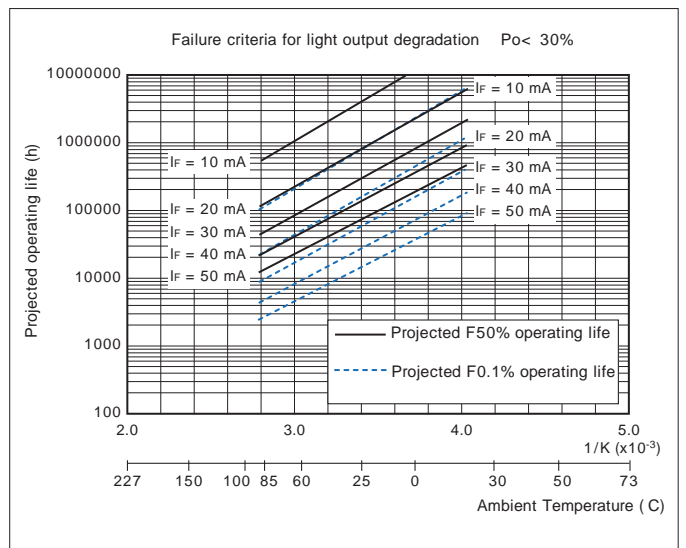
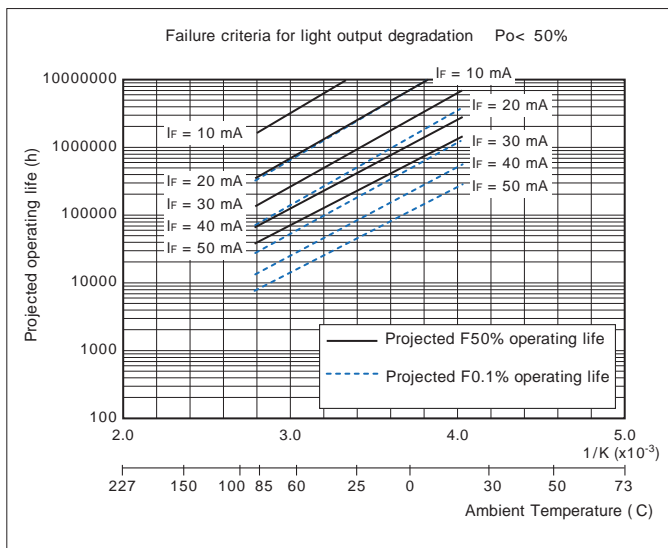

The above operating life data are estimates extrapolated from long-term light output degradation over a single wafer lot and are shown as reference only. Operating conditions exceeding the maximum ratings are not guaranteed.

② GaAIAs (SH) LED

Projected Light Output Degradation Data

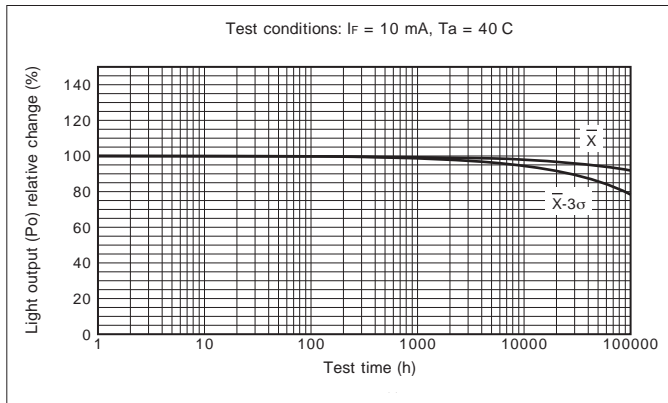
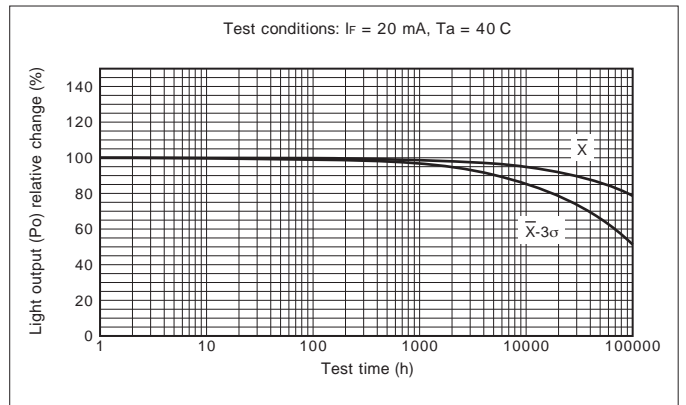
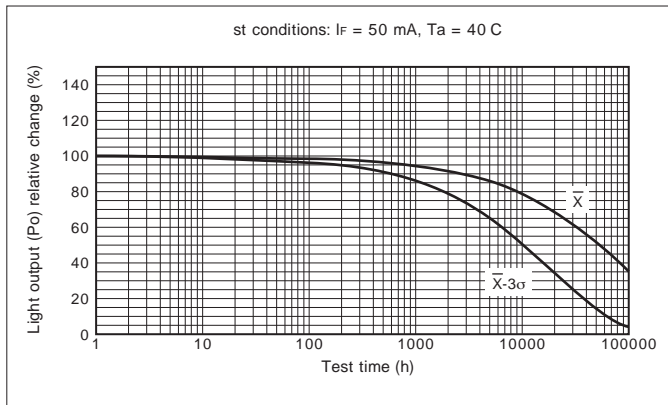

Projected Operating Life Data

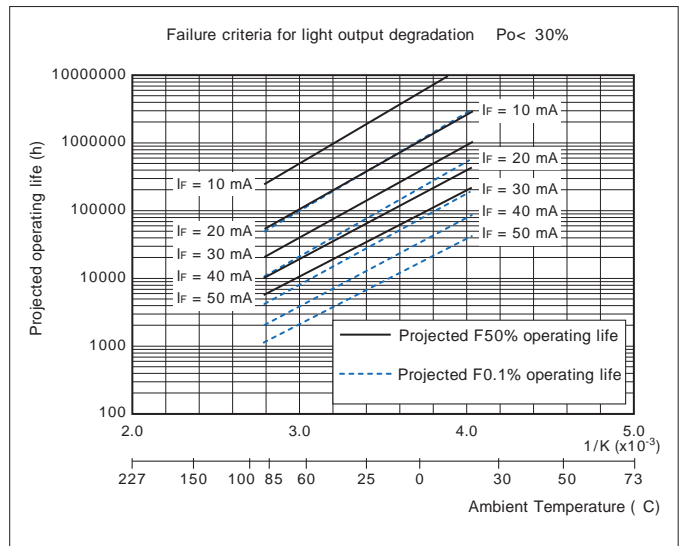
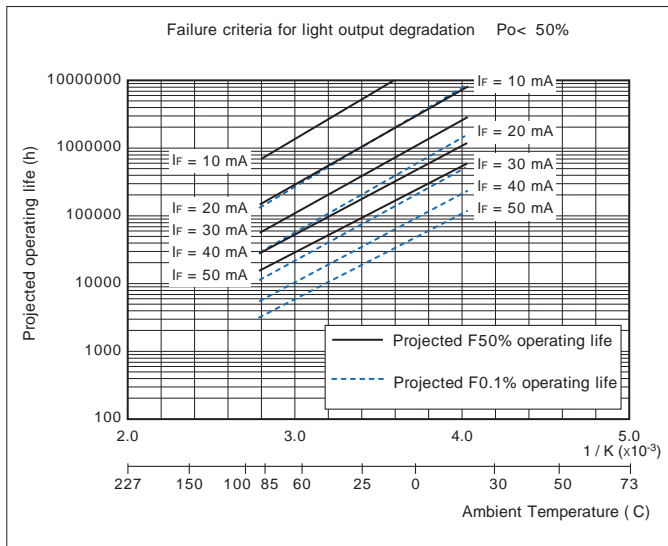

The above operating life data are estimates extrapolated from long-term light output degradation over a single wafer lot and are shown as reference only. Operating conditions exceeding the maximum ratings are not guaranteed.

③ GaAlAs (DH) LED

Projected Light Output Degradation Data

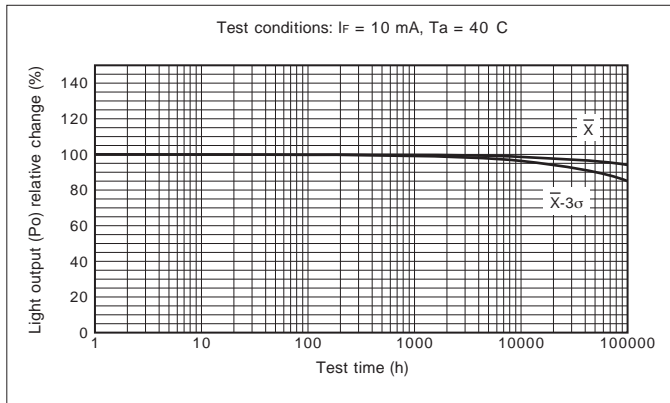
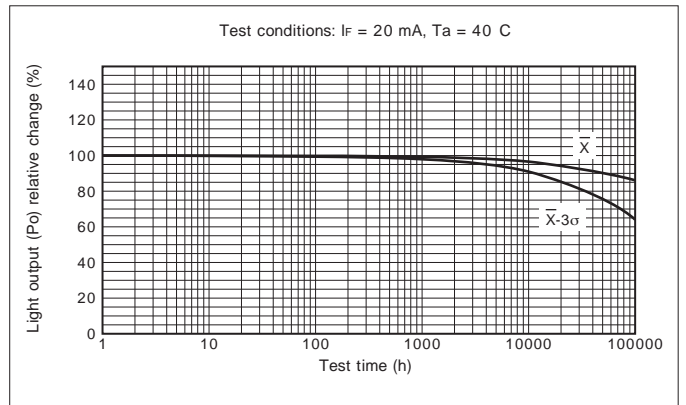
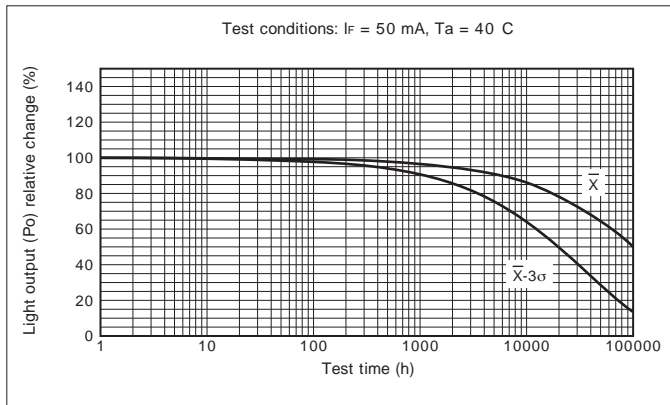

Projected Operating Life Data

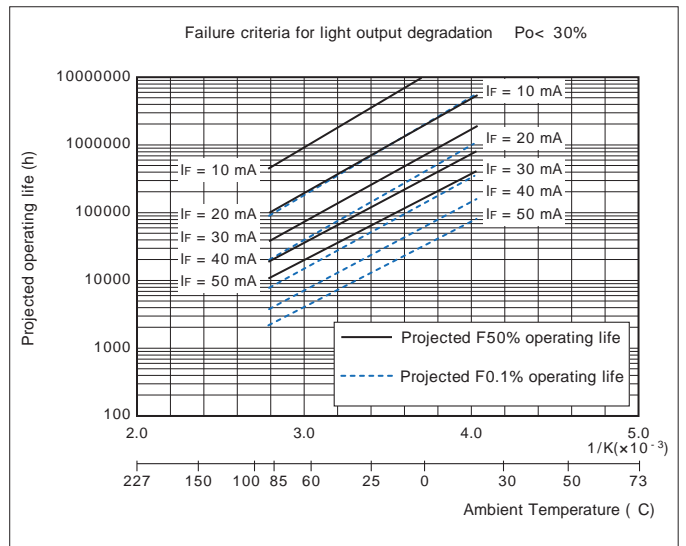
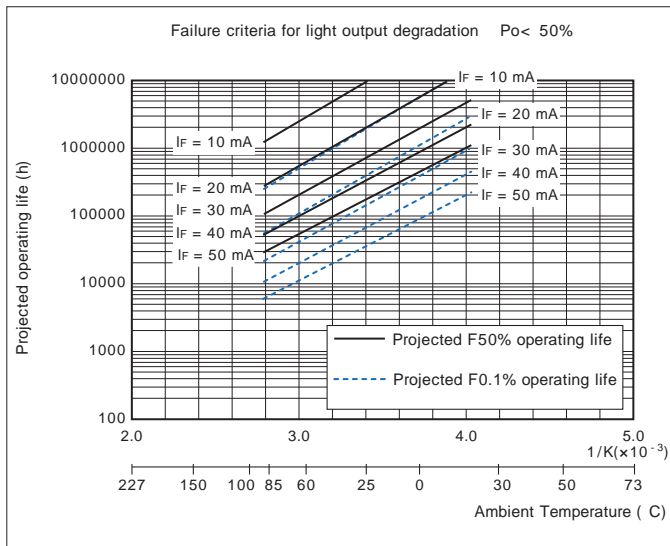

The above operating life data are estimates extrapolated from long-term light output degradation over a single wafer lot and are shown as reference only. Operating conditions exceeding the maximum ratings are not guaranteed.

④ GaAlAs (MQW) LED

Projected Light Output Degradation and Operating Life Data

Toshiba is now preparing the light output degradation and operating life data for GaAlAs (MQW) LEDs. These data are available for individual LEDs. Ask your local Toshiba sales representative.

■ Reading the Projected LED Operating Life Graph

For example, let's calculate the operating life of the GaAs LED, based on the data shown on page 58.

Here is an example of how to read an operating life, assuming that the ambient temperature (T_a) is 40°C and that the failure criterion is a 30% decrease in light output.

Suppose that the initial LED current, I_F , is 20 mA. Since the horizontal axis of the failure criteria graph is the reciprocal of absolute temperature, it is necessary to convert the ambient temperature (T_a) to the reciprocal of absolute temperature (T):

$$T = \frac{1}{T_a + 273.15} = \frac{1}{40 + 273.15} \approx 3.19 \times 10^{-3}$$

The graph shows the projected lifetimes for F50% and F0.1% cumulative failure probabilities in solid and dashed lines respectively. Normally, it is recommended to use F0.1% lines. As $X = 3.19$, its intersection with the $I_F = 20$ mA line for F0.1% is approximately 80,000 hours. (This figure is for reference only.)

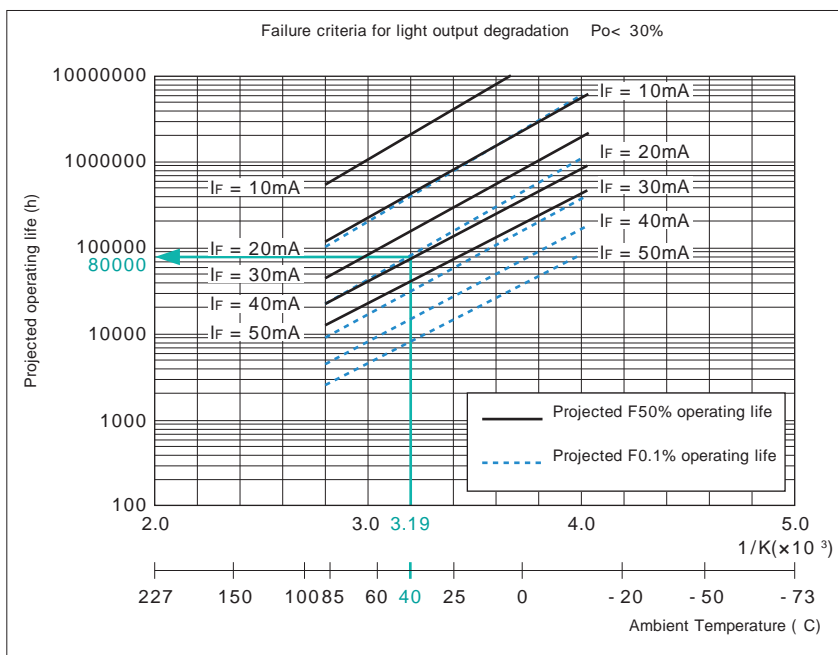

You can also estimate the projected operating life from the projected light output degradation data.

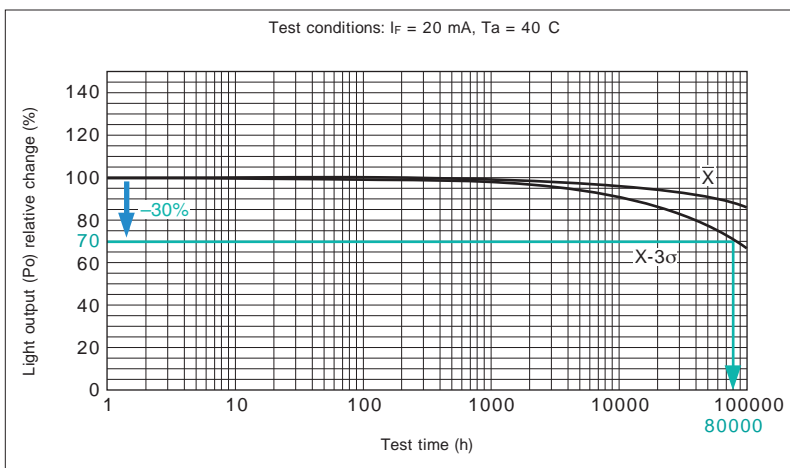

Safety Standard Approvals

■ Safety Standard Approvals for Photocouplers (DIN EN60747-5)

Mechanical Construction		Reflective Photocouplers in Single-Molded Packages			Transmissive Photocouplers in Single-Molded Packages				
Internal Construction									
Package		SOP4/SOP16		MFSO6	MFSOP6	SO8 (2ch)	2.54SOP 4/6/8	DIP	DIP (F type)
Construction Mechanical Ratings (min)	Isolation Creepage Path (mm)	4.0	5.0	4.0	4.0	4.2	4.0	6.4/7.0	8.0
	Isolation Clearance (mm)	4.0	5.0	4.0	4.0	4.2	4.0	6.4/7.0	8.0
	Isolation Thickness (mm)	0.4	0.4	0.4	—	—	—	(0.4)	(0.4)
	Internal Creepage Path (mm)	—	—	—	—	—	—	—	—
VDE/TÜV DIN EN 60747-5-5	Max Working Insulation Voltage (Viorm)	565 Vpk	707 Vpk	565 Vpk	565 Vpk	565 Vpk	565 Vpk	630 Vpk /890 Vpk	1140 Vpk
	Highest Allowable Overvoltage (Viotm)	4000 Vpk	6000 Vpk	6000 Vpk	4000 Vpk	4000 Vpk	2500 Vpk	4000 Vpk	6000 Vpk
Certified Devices	IC Output					TLP2105 TLP2108 TLP2166A TLP2116 TLP2118E TLP2168 TLP2160		TLP350 TLP351 TLP559	TLP350F TLP351F
	Transistor Output	TLP280-4 TLP281-4			TLP127				
	Triac/Thyristor Output				TLP160G TLP160J TLP161G TLP161J TLP168J			TLP560G TLP560J TLP561G TLP561J	
	Photorelay/ Photovoltaic						TLP176A TLP176D TLP176G TLP197G TLP206G	TLP227G TLP227G-2 TLP597G	

Toshiba offers a wide selection of photocouplers with a transistor output, IC output, thyristor output and triac output, as well as photorelays certified to UL (USA), c-UL (Canada), VDE (Germany), BSI (Britain), SEMKO (Sweden) and CQC (China).

The table above lists photocouplers and photorelays that have already been approved as of April 2015. The information herein is subject to change. For the latest information, please contact your nearest Toshiba sales representative.

Transmissive Photocouplers with an Insulating Film in Single-Molded packages						Transmissive Photocouplers in Double-Molded Packages						
SO8 (1 ch)	SDIP6	SDIP6 (F type)	DIP	DIP (F type)	MFSOP6	SO4	SO6	SO6L	SO16	DIP	DIP (F type)	
4.0	7.0	8.0	6.4/7.0	8.0	4.0	5.0	5.0	8.0	5.0	6.5/7.0	8.0	
4.0	7.0	8.0	6.4/7.0	8.0	4.0	5.0	5.0	8.0	5.0	6.5/7.0	8.0	
—	0.4	0.4	0.4/0.5	0.4/0.5	—	0.4	0.4	0.4	—	0.4/0.5	0.4/0.5	
—	—	—	—	—	—	—	—	—	—	0.4/0.5	4.0	
565 Vpk	890 Vpk	1140 Vpk	890 Vpk	1140 Vpk	565 Vpk	707 Vpk	707 Vpk	1140 Vpk /1230 Vpk	565 Vpk	890 Vpk /1130 Vpk	890 Vpk /1130 Vpk	
6000 Vpk	8000 Vpk	8000 Vpk	6000 Vpk /8000 Vpk	6000 Vpk /8000 Vpk	4000 Vpk /6000 Vpk	6000 Vpk	6000 Vpk	8000 Vpk	4000 Vpk	6000 Vpk /8000 Vpk	6000 Vpk /8000 Vpk	
TLP2403 TLP2404 TLP2405 TLP2408 TLP2409 TLP2418 TLP2451A TLP2466 TLP2468	TLP700 TLP700A TLP700H TLP701 TLP701A TLP701H TLP705A TLP708 TLP714 TLP715 TLP716 TLP718 TLP719 TLP2766 TLP2768	TLP700F TLP700AF TLP700HF TLP701F TLP701AF TLP701HF TLP705AF TLP708F TLP714F TLP715F TLP716F TLP718F TLP719F TLP2766F TLP2768F	TLP750 TLP751 TLP759 TLP350H TLP351H TLP352 TLP358 TLP358H TLP358HF TLPN137 TLP250H TLP351AF TLP754F TLP754 TLP2662 TLP2955 TLP2958 TLP2962	TLP750F TLP751F TLP759F TLP350HF TLP351HF TLP352F TLP358F TLP358HF TLP250HF TLP351AF TLP754F TLP2662F TLP2955F TLP2958F TLP2962F	TLP117 TLP2066 TLP2095 TLP2098		TLP109 TLP116A TLP104 TLP118 TLP151A TLP155 TLP155E TLP2309 TLP2345 TLP2348 TLP2355 TLP2358 TLP2362 TLP2366 TLP2368 TLP152 TLP2301 TLP2303 TLP2361 TLP2391 TLP2395 TLP2398	TLP2703 TLP2768A TLP5701 TLP5702 TLP5751 TLP5752 TLP5754				
			TLP620 TLP624 TLP626 TLP627 TLP628 TLP731 TLP732	TLP620F		TLP290(SE) TLP291(SE) TLP292 TLP293	TLP184(SE) TLP185(SE) TLP182 TLP183 TLP187 TLP188	TLP385	TLP290-4 TLP291-4 TLP292-4 TLP293-4	TLP733 TLP734 TLP785	TLP733F TLP734F TLP785F	
			TLP360J TLP361J TLP363J TLP3022(S) TLP3023(S) TLP3042(S) TLP3043(S) TLP3052(S) TLP3062(S) TLP3063(S) TLP3064(S) TLP3082(S) TLP3762(S) TLP3782(S) TLP3783(S) TLP663J(S) TLP665G(S) TLP665J(S) TLP666G(S) TLP666L(S) TLP668J(S) TLP669L(S)	TLP360JF TLP361JF TLP363JF TLP3022F(S) TLP3023F(S) TLP3042F(S) TLP3043F(S) TLP3052F(S) TLP3062F(S) TLP3063F(S) TLP3064F(S) TLP3082F(S) TLP3762F(S) TLP3782F(S) TLP3783F(S) TLP663JF(S) TLP665GF(S) TLP665JF(S) TLP666GF(S) TLP666LF(S) TLP668JF(S) TLP669LF(S)	TLP165J TLP166J		TLP265J TLP266J TLP267J TLP268J		TLP762J TLP763J TLP748J	TLP762JF TLP763JF TLP748JF		
			TLP797GA TLP797J	TLP797GAF TLP797JF			TLP175A TLP3905 TLP3906			TLP220A TLP220D TLP220G TLP220GA TLP220J TLP221A TLP240A TLP240D TLP240G TLP240GA TLP240J TLP241A	TLP220AF TLP220DF TLP220GF TLP220GAF TLP220JF TLP221AF TLP240AF TLP240DF TLP240GF TLP240GAF TLP240JF TLP241AF	

Part Number Index

Photocouplers

Part Number	Package	Output	Page
6N135	DIP8	IC	15
6N136	DIP8	IC	15
6N137	DIP8	IC	15
6N138	DIP8	IC	15
6N139	DIP8	IC	15
TLP104	5 pin SO6	IC	19
TLP109	5 pin SO6	IC	8
TLP109 (IGM)	5 pin SO6	IC	19
TLP116A	5 pin SO6	IC	14
TLP117	5 pin MFSOP6	IC	15
TLP118	5 pin SO6	IC	14
TLP148G	5 pin MFSOP6	Thyristor	29
TLP151A	5 pin SO6	IC	16
TLP152	5 pin SO6	IC	16
TLP155	5 pin SO6	IC	16
TLP155E	5 pin SO6	IC	16
TLP163J	4 pin MFSOP6 (cut)	Triac	26
TLP182	4 pin SO6	Transistor	24
TLP183	4 pin SO6	Transistor	22
TLP184 (SE)	4 pin SO6	Transistor	24
TLP185 (SE)	4 pin SO6	Transistor	22
TLP187	4 pin SO6	Transistor	24
TLP188	4 pin SO6	Transistor	22
TLP190B	4 pin MFSOP6	Photovoltaic	30
TLP191B	4 pin MFSOP6	Photovoltaic	30
TLP2066	5 pin MFSOP6	IC	14
TLP2095	MFSOP6	IC	10
TLP2098	MFSOP6	IC	10
TLP2105	SO8	IC	10
TLP2108	SO8	IC	10
TLP2110	SO8	IC	10
TLP2116	SO8	IC	13
TLP2118E	SO8	IC	13
TLP2160	SO8	IC	14
TLP2161	SO8	IC	13
TLP2166A	SO8	IC	13
TLP2167	SO8	IC	15
TLP2168	SO8	IC	14
TLP2200	DIP8	IC	10
TLP2301	4 pin SO6	IC	8
TLP2301	4 pin SO6	Transistor	23
TLP2303	5 pin SO6	IC	8
TLP2309	5 pin SO6	IC	9
TLP2310	5 pin SO6	IC	10
TLP2345	5 pin SO6	IC	11
TLP2345	5 pin SO6	IC	20
TLP2348	5 pin SO6	IC	11
TLP2348	5 pin SO6	IC	20
TLP2355	5 pin SO6	IC	10
TLP2355	5 pin SO6	IC	20
TLP2358	5 pin SO6	IC	10
TLP2358	5 pin SO6	IC	20
TLP2361	5 pin SO6	IC	13
TLP2362	5 pin SO6	IC	12
TLP2366	5 pin SO6	IC	14
TLP2367	5 pin SO6	IC	15
TLP2368	5 pin SO6	IC	14
TLP2391	5 pin SO6	IC	12
TLP2395	5 pin SO6	IC	11
TLP2398	5 pin SO6	IC	11
TLP2403	SO8	IC	8
TLP2404	SO8	IC	20
TLP2405	SO8	IC	11
TLP2405	SO8	IC	20
TLP2408	SO8	IC	11
TLP2408	SO8	IC	20
TLP2409	SO8	IC	9
TLP2418	SO8	IC	14
TLP2451A	SO8	IC	18
TLP2466	SO8	IC	14
TLP2468	SO8	IC	14
TLP250H	DIP8	IC	17
TLP250HF	DIP8	IC	17
TLP2530	DIP8	IC	9
TLP2531	DIP8	IC	9
TLP2601	DIP8	IC	12
TLP2630	DIP8	IC	12
TLP2631	DIP8	IC	12
TLP265J	4 pin SO6	Triac	26
TLP2662	DIP8	IC	12
TLP2662F	DIP8	IC	12
TLP266J	4 pin SO6	Triac	26
TLP267J	4 pin SO6	Triac	26
TLP268J	4 pin SO6	Triac	27
TLP2703	SO6L	IC	8
TLP2704	SO6L	IC	19
TLP2710	SO6L	IC	11
TLP2745	SO6L	IC	12
TLP2748	SO6L	IC	12

Part Number	Package	Output	Page
TLP2761	SO6L	IC	13
TLP2766	SDIP6	IC	14
TLP2766F	SDIP6	IC	14
TLP2767	SDIP6	IC	15
TLP2767F	SDIP6	IC	15
TLP2768	SDIP6	IC	14
TLP2768A	SO6L	IC	15
TLP2768F	SDIP6	IC	14
TLP290 (SE)	SO4	Transistor	24
TLP290-4	SO16	Transistor	24
TLP291 (SE)	SO4	Transistor	22
TLP291-4	SO16	Transistor	22
TLP292	SO4	Transistor	24
TLP292-4	SO16	Transistor	24
TLP293	SO4	Transistor	22
TLP293-4	SO16	Transistor	22
TLP2955	DIP8	IC	11
TLP2955	DIP8	IC	20
TLP2955F	DIP8	IC	11
TLP2955F	DIP8	IC	20
TLP2958	DIP8	IC	11
TLP2958	DIP8	IC	20
TLP2958F	DIP8	IC	11
TLP2958F	DIP8	IC	20
TLP2962	DIP8	IC	12
TLP2962F	DIP8	IC	12
TLP3022 (S)	5 pin DIP6 (cut)	Triac	26
TLP3022F (S)	5 pin DIP6 (cut)	Triac	26
TLP3023 (S)	5 pin DIP6 (cut)	Triac	26
TLP3023F (S)	5 pin DIP6 (cut)	Triac	26
TLP3042 (S)	5 pin DIP6 (cut)	Triac	26
TLP3042F (S)	5 pin DIP6 (cut)	Triac	26
TLP3043 (S)	5 pin DIP6 (cut)	Triac	26
TLP3043F (S)	5 pin DIP6 (cut)	Triac	26
TLP3052A	5 pin DIP6	Triac	27
TLP3062 (S)	5 pin DIP6 (cut)	Triac	27
TLP3062A	5 pin DIP6	Triac	27
TLP3062F (S)	5 pin DIP6 (cut)	Triac	27
TLP3063 (S)	5 pin DIP6 (cut)	Triac	27
TLP3063F (S)	5 pin DIP6 (cut)	Triac	27
TLP3064 (S)	5 pin DIP6 (cut)	Triac	27
TLP3064F (S)	5 pin DIP6 (cut)	Triac	27
TLP3073	5 pin DIP6	Triac	28
TLP3082 (S)	5 pin DIP6 (cut)	Triac	28
TLP3082F (S)	5 pin DIP6 (cut)	Triac	28
TLP3083	5 pin DIP6 (cut)	Triac	28
TLP350H	DIP8	IC	17
TLP350HF	DIP8	IC	17
TLP351	DIP8	IC	17
TLP351A	DIP8	IC	17
TLP351AF	DIP8	IC	17
TLP351F	DIP8	IC	17
TLP351H	DIP8	IC	17
TLP351HF	DIP8	IC	17
TLP352	DIP8	IC	17
TLP352F	DIP8	IC	17
TLP358	DIP8	IC	17
TLP358F	DIP8	IC	17
TLP358H	DIP8	IC	17
TLP358HF	DIP8	IC	17
TLP360J	DIP4	Triac	27
TLP360JF	DIP4	Triac	27
TLP361J	DIP4	Triac	27
TLP361JF	DIP4	Triac	27
TLP363J	DIP4	Triac	27
TLP363JF	DIP4	Triac	27
TLP3782 (S)	5 pin DIP6	Triac	28
TLP3783 (S)	5 pin DIP6	Triac	28
TLP3783F (S)	5 pin DIP6	Triac	28
TLP3787F (S)	5 pin DIP6	Triac	28
TLP383	4 pin SO6L	Transistor	23
TLP385	4 pin SO6L	Transistor	23
TLP3902	4 pin MFSOP6	Photovoltaic	30
TLP3904	SSOP4	Photovoltaic	30
TLP3905	4 pin SO6	Photovoltaic	30
TLP3906	4 pin SO6	Photovoltaic	30
TLP3914	SSOP4	Photovoltaic	30
TLP3924	SSOP4	Photovoltaic	30
TLP512	DIP6	IC	8
TLP5214	SO16L	IC	18
TLP525G	DIP4	Triac	26
TLP548J	DIP6	Thyristor	29
TLP549J	7 pin DIP8	Thyristor	29
TLP550	DIP8	IC	8
TLP551	DIP8	IC	8
TLP552	DIP8	IC	11
TLP553	DIP8	IC	8
TLP554	DIP8	IC	11
TLP555	DIP8	IC	10

Part Number	Package	Output	Page
TLP557	DIP8	IC	17
TLP558	DIP8	IC	10
TLP559	DIP8	IC	9
TLP559 (IGM)	DIP8	IC	19
TLP560G	5 pin DIP6 (cut)	Triac	26
TLP560J	5 pin DIP6 (cut)	Triac	27
TLP561G	5 pin DIP6 (cut)	Triac	26
TLP561J	5 pin DIP6 (cut)	Triac	27
TLP5701	SO6L	IC	18
TLP5702	SO6L	IC	18
TLP5751	SO6L	IC	18
TLP5752	SO6L	IC	18
TLP5754	SO6L	IC	18
TLP590B	5 pin DIP6 (cut)	Photovoltaic	30
TLP591B	5 pin DIP6 (cut)	Photovoltaic	30
TLP627	DIP4	Transistor	24
TLP651	DIP8	IC	9
TLP663J (S)	5 pin DIP6 (cut)	Triac	28
TLP663JF (S)	5 pin DIP6 (cut)	Triac	28
TLP665G (S)	5 pin DIP6 (cut)	Triac	28
TLP665GF (S)	5 pin DIP6 (cut)	Triac	28
TLP665J (S)	5 pin DIP6 (cut)	Triac	28
TLP665JF (S)	5 pin DIP6 (cut)	Triac	28
TLP665L (S)	5 pin DIP6 (cut)	Triac	28
TLP665LF (S)	5 pin DIP6 (cut)	Triac	28
TLP666G (S)	5 pin DIP6 (cut)	Triac	28
TLP666GF (S)	5 pin DIP6 (cut)	Triac	28
TLP666J (S)	5 pin DIP6 (cut)	Triac	28
TLP666JF (S)	5 pin DIP6 (cut)	Triac	28
TLP666L (S)	5 pin DIP6 (cut)	Triac	28
TLP666LF (S)	5 pin DIP6 (cut)	Triac	28
TLP668J (S)	5 pin DIP6 (cut)	Triac	28
TLP668JF (S)	5 pin DIP6 (cut)	Triac	28
TLP669L (S)	5 pin DIP6	Triac	28
TLP669LF (S)	5 pin DIP6	Triac	28
TLP700	SDIP6	IC	17
TLP700A	SDIP6	IC	17
TLP700AF	SDIP6	IC	17
TLP700F	SDIP6	IC	17
TLP700H	SDIP6	IC	17
TLP700HF	SDIP6	IC	17
TLP701	SDIP6	IC	18
TLP701A	SDIP6	IC	18
TLP701AF	SDIP6	IC	18
TLP701F	SDIP6	IC	18
TLP701H	SDIP6	IC	18
TLP701HF	SDIP6	IC	18
TLP705A	SDIP6	IC	18
TLP705AF	SDIP6	IC	18
TLP708	SDIP6	IC	13
TLP708F	SDIP6	IC	13
TLP714	SDIP6	IC	19
TLP714F	SDIP6	IC	19
TLP715	SDIP6	IC	10
TLP715	SDIP6	IC	19
TLP715F	SDIP6	IC	10
TLP715F	SDIP6	IC	19
TLP716	SDIP6	IC	13
TLP716F	SDIP6	IC	13
TLP718	SDIP6	IC	10
TLP718	SDIP6	IC	19
TLP718F	SDIP6	IC	10
TLP718F	SDIP6	IC	19
TLP719	SDIP6	IC	9
TLP719F	SDIP6	IC	9
TLP731	DIP6	Transistor	23
TLP732	DIP6	Transistor	23
TLP748J	DIP6	Thyristor	29
TLP748JF	DIP6	Thyristor	29
TLP751	DIP8	IC	9
TLP751F	DIP8	IC	9
TLP754	DIP8	IC	19
TLP754F	DIP8	IC	19
TLP759	DIP8	IC	9
TLP759 (IGM)	DIP8	IC	20
TLP759F	DIP8	IC	9
TLP759F (IGM)	DIP8	IC	20
TLP762J	5 pin DIP6	Triac	27
TLP762JF	5 pin DIP6	Triac	27
TLP763J	5 pin DIP6	Triac	27
TLP763JF	5 pin DIP6	Triac	27
TLP7820	SO8L		6
TLP7830	SO8L		6
TLP7920	DIP8		6
TLP7930	DIP8		6
TLP785	DIP4	Transistor	23
TLP785F	DIP4	Transistor	23
TLPN137	DIP8	IC	12

Photorelays

Part Number	Package	Output	Page
TLP170A	2.54SOP4	MOSFET	35
TLP170D	2.54SOP4	MOSFET	35
TLP170G	2.54SOP4	MOSFET	35
TLP170J	2.54SOP4	MOSFET	35
TLP171A	2.54SOP4	MOSFET	36
TLP171D	2.54SOP4	MOSFET	36
TLP171GA	2.54SOP4	MOSFET	36
TLP171J	2.54SOP4	MOSFET	36
TLP172A	2.54SOP4	MOSFET	36
TLP172G	2.54SOP4	MOSFET	36
TLP174G	2.54SOP4	MOSFET	36
TLP174GA	2.54SOP4	MOSFET	36
TLP175A	4 pin SO6	MOSFET	35
TLP176A	2.54SOP4	MOSFET	36
TLP176D	2.54SOP4	MOSFET	36
TLP176G	2.54SOP4	MOSFET	36
TLP176GA	2.54SOP4	MOSFET	36
TLP179D	2.54SOP4	MOSFET	36
TLP192A	2.54SOP6	MOSFET	37
TLP192G	2.54SOP6	MOSFET	37
TLP197A	2.54SOP6	MOSFET	37
TLP197D	2.54SOP6	MOSFET	37
TLP197G	2.54SOP6	MOSFET	37
TLP197GA	2.54SOP6	MOSFET	37
TLP199D	2.54SOP6	MOSFET	37
TLP200D	2.54SOP8	MOSFET	38
TLP202A	2.54SOP8	MOSFET	38
TLP202G	2.54SOP8	MOSFET	38
TLP206A	2.54SOP8	MOSFET	38
TLP206G	2.54SOP8	MOSFET	38
TLP206GA	2.54SOP8	MOSFET	38
TLP209D	2.54SOP8	MOSFET	38
TLP221A	DIP4	MOSFET	39
TLP221AF	DIP4	MOSFET	39
TLP222A	DIP4	MOSFET	39
TLP222A-2	DIP8	MOSFET	41
TLP222D	DIP4	MOSFET	39
TLP222G	DIP4	MOSFET	39
TLP222G-2	DIP8	MOSFET	41
TLP224G	DIP4	MOSFET	39
TLP224G-2	DIP8	MOSFET	41
TLP224GA	DIP4	MOSFET	39
TLP224GA-2	DIP8	MOSFET	41
TLP225A	DIP4	MOSFET	39
TLP227A	DIP4	MOSFET	39
TLP227A-2	DIP8	MOSFET	41
TLP227G	DIP4	MOSFET	39
TLP227G-2	DIP8	MOSFET	41
TLP227GA	DIP4	MOSFET	39
TLP227GA-2	DIP8	MOSFET	41
TLP228G	DIP4	MOSFET	39

Part Number	Package	Output	Page
TLP228G-2	DIP8	MOSFET	41
TLP240A	DIP4	MOSFET	39
TLP240AF	DIP4	MOSFET	39
TLP240D	DIP4	MOSFET	39
TLP240DF	DIP4	MOSFET	39
TLP240G	DIP4	MOSFET	39
TLP240GA	DIP4	MOSFET	39
TLP240GAF	DIP4	MOSFET	39
TLP240GF	DIP4	MOSFET	39
TLP240J	DIP4	MOSFET	39
TLP240JF	DIP4	MOSFET	39
TLP241A	DIP4	MOSFET	39
TLP241AF	DIP4	MOSFET	39
TLP3100	2.54SOP6	MOSFET	37
TLP3102	2.54SOP6	MOSFET	37
TLP3103	2.54SOP6	MOSFET	38
TLP3105	2.54SOP6	MOSFET	38
TLP3107	2.54SOP6	MOSFET	38
TLP3111	2.54SOP4	MOSFET	36
TLP3114	2.54SOP4	MOSFET	36
TLP3115	2.54SOP4	MOSFET	36
TLP3116	2.54SOP4	MOSFET	36
TLP3118	2.54SOP4	MOSFET	36
TLP3119	2.54SOP4	MOSFET	36
TLP3120	2.54SOP6	MOSFET	38
TLP3121	2.54SOP4	MOSFET	37
TLP3122	2.54SOP4	MOSFET	37
TLP3123	2.54SOP4	MOSFET	37
TLP3125	2.54SOP8	MOSFET	38
TLP3127	2.54SOP4	MOSFET	37
TLP3130	2.54SOP4	MOSFET	37
TLP3131	2.54SOP4	MOSFET	37
TLP3203	SSOP4	MOSFET	34
TLP3212	SSOP4	MOSFET	34
TLP3214	SSOP4	MOSFET	34
TLP3215	SSOP4	MOSFET	35
TLP3216	SSOP4	MOSFET	35
TLP3217	SSOP4	MOSFET	35
TLP3220	SSOP4	MOSFET	35
TLP3230	SSOP4	MOSFET	35
TLP3231	SSOP4	MOSFET	35
TLP3240	SSOP4	MOSFET	35
TLP3241	SSOP4	MOSFET	35
TLP3250	SSOP4	MOSFET	35
TLP3275	SSOP4	MOSFET	35
TLP3303	USOP4	MOSFET	33
TLP3306	USOP4	MOSFET	33
TLP3312	USOP4	MOSFET	33
TLP3315	USOP4	MOSFET	34
TLP3316	USOP4	MOSFET	34
TLP3317	USOP4	MOSFET	34

Part Number	Package	Output	Page
TLP3319	USOP4	MOSFET	34
TLP3320	USOP4	MOSFET	34
TLP3330	USOP4	MOSFET	34
TLP3331	USOP4	MOSFET	34
TLP3340	USOP4	MOSFET	34
TLP3341	USOP4	MOSFET	34
TLP3342	USOP4	MOSFET	34
TLP3350	USOP4	MOSFET	34
TLP3351	USOP4	MOSFET	34
TLP3375	USOP4	MOSFET	34
TLP3403	VSON4	MOSFET	33
TLP3412	VSON4	MOSFET	33
TLP3417	VSON4	MOSFET	33
TLP3419	VSON4	MOSFET	33
TLP3420	VSON4	MOSFET	33
TLP3431	VSON4	MOSFET	33
TLP3440	VSON4	MOSFET	33
TLP3441	VSON4	MOSFET	33
TLP3442	VSON4	MOSFET	33
TLP3450	VSON4	MOSFET	33
TLP3451	VSON4	MOSFET	33
TLP3475	VSON4	MOSFET	33
TLP3542	DIP6	MOSFET	40
TLP3543	DIP6	MOSFET	40
TLP3544	DIP6	MOSFET	40
TLP3545	DIP6	MOSFET	40
TLP3546	DIP6	MOSFET	40
TLP3553	DIP4	MOSFET	39
TLP3554	DIP4	MOSFET	39
TLP3555	DIP4	MOSFET	39
TLP3556	DIP4	MOSFET	39
TLP4006G	DIP8	MOSFET	42
TLP4026G	2.54SOP4	MOSFET	42
TLP4176G	2.54SOP4	MOSFET	41
TLP4197G	2.54SOP4	MOSFET	41
TLP4206G	2.54SOP8	MOSFET	42
TLP4227G	DIP4	MOSFET	41
TLP4227G-2	DIP8	MOSFET	42
TLP4597G	DIP6	MOSFET	41
TLP592A	DIP6	MOSFET	40
TLP592G	DIP6	MOSFET	40
TLP597A	DIP6	MOSFET	40
TLP597G	DIP6	MOSFET	40
TLP597GA	DIP6	MOSFET	40
TLP598AA	DIP6	MOSFET	40
TLP598GA	DIP6	MOSFET	40
TLP797GA	DIP6	MOSFET	40
TLP797GAF	DIP6	MOSFET	40
TLP797J	DIP6	MOSFET	40
TLP797JF	DIP6	MOSFET	40
TLP798GA	DIP6	MOSFET	40

SALES OFFICES

SUBSIDIARIES AND AFFILIATES

(As of April 15, 2015)

Toshiba America

Electronic Components, Inc.

- Irvine, Headquarters
Tel: (949)462-7700 Fax: (949)462-2200
- Buffalo Grove (Chicago)
Tel: (847)484-2400 Fax: (847)541-7287
- Duluth/Atlanta
Tel: (770)931-3363 Fax: (770)931-7602
- El Paso
Tel: (915)533-4242
- Marlborough
Tel: (508)481-0034 Fax: (508)481-8828
- Parsippany
Tel: (973)541-4715 Fax: (973)541-4716
- San Jose
Tel: (408)526-2400 Fax: (408)526-2410
- Wixom (Detroit)
Tel: (248)347-2607 Fax: (248)347-2602

TOSHIBA América do Sul Ltda.

Tel: (011)4083-7978

Toshiba India Private Ltd.

- New Delhi Office
Tel: (0124)499-6600 Fax: (0124)499-6611
- Bangalore Office
Tel: (080)251-9080 Fax: (080)490-91945

Toshiba Electronics Europe GmbH

- Düsseldorf Head Office
Tel: (0211)5296-0 Fax: (0211)5296-400
- France Branch
Tel: (1)47282181
- Italy Branch
Tel: (039)68701 Fax: (039)6870205
- Munich Office
Tel: (089)20302030 Fax: (089)203020310
- Spain Branch
Tel: (91)660-6798 Fax: (91)660-6799
- Sweden Branch
Tel: (08)704-0900 Fax: (08)80-8459
- U.K. Branch
Tel: (1932)841600

Toshiba Vietnam Consumer Products Co.,Ltd.

Tel: (043)776-5950 Fax: (043)776-5956

Toshiba Electronics Asia (Singapore) Pte. Ltd.

Tel: (6278)5252 Fax: (6271)5155

Toshiba Electronics Service (Thailand) Co., Ltd.

Tel: (02)835-3491 Fax: (02)835-3490

Toshiba Electronics Trading (Malaysia)Sdn. Bhd.

- Kuala Lumpur Head Office
Tel: (03)5631-6311 Fax: (03)5631-6307
- Penang Office
Tel: (04)226-8523 Fax: (04)226-8515

Toshiba Electronics (China) Co., Ltd.

- Shanghai Head Office
Tel: (021)6139-3888 Fax: (021)6190-8288
 - Beijing Branch
Tel: (010)6590-8796 Fax: (010)6590-8791
 - Chengdu Branch
Tel: (028)8675-1773 Fax: (028)8675-1065
 - Hangzhou Office
Tel: (0571)8717-5004 Fax: (0571)8717-5013
 - Nanjing Office
Tel: (025)8689-0070 Fax: (025)8689-0125
 - Qingdao Branch
Tel: (532)8579-3328 Fax: (532)8579-3329
 - Shenzhen Branch
Tel: (0755)3686-0880 Fax: (0755)3686-0816
 - Dalian Branch
Tel: (0411)8368-6882 Fax: (0411)8369-0822
 - Xiamen Branch
Tel: (0592)226-1398 Fax: (0592)226-1399
 - Dongguan Branch
Tel: (0769)8155-6858 Fax: (0769)8155-6368
- Toshiba Electronics Asia, Ltd.**
Tel: 2375-6111 Fax: 2375-0969
- Toshiba Electronics Korea Corporation**
Tel: (02)3484-4334 Fax: (02)3484-4302
- Toshiba Electronic Components Taiwan Corporation**
Tel: (02)2508-9988 Fax: (02)2508-9999

RESTRICTIONS ON PRODUCT USE

- ▶ Toshiba Corporation, and its subsidiaries and affiliates (collectively "TOSHIBA"), reserve the right to make changes to the information in this document, and related hardware, software and systems (collectively "Product") without notice.
- ▶ This document and any information herein may not be reproduced without prior written permission from TOSHIBA. Even with TOSHIBA's written permission, reproduction is permissible only if reproduction is without alteration/omission.
- ▶ Though TOSHIBA works continually to improve Product's quality and reliability, Product can malfunction or fail. Customers are responsible for complying with safety standards and for providing adequate designs and safeguards for their hardware, software and systems which minimize risk and avoid situations in which a malfunction or failure of Product could cause loss of human life, bodily injury or damage to property, including data loss or corruption. Before customers use the Product, create designs including the Product, or incorporate the Product into their own applications, customers must also refer to and comply with (a) the latest versions of all relevant TOSHIBA information, including without limitation, this document, the specifications, the data sheets and application notes for Product and the precautions and conditions set forth in the "TOSHIBA Semiconductor Reliability Handbook" and (b) the instructions for the application with which the Product will be used with or for. Customers are solely responsible for all aspects of their own product design or applications, including but not limited to (a) determining the appropriateness of the use of this Product in such design or applications; (b) evaluating and determining the applicability of any information contained in this document, or in charts, diagrams, programs, algorithms, sample application circuits, or any other referenced documents; and (c) validating all operating parameters for such designs and applications. **TOSHIBA ASSUMES NO LIABILITY FOR CUSTOMERS' PRODUCT DESIGN OR APPLICATIONS.**
- ▶ **PRODUCT IS NEITHER INTENDED NOR WARRANTED FOR USE IN EQUIPMENTS OR SYSTEMS THAT REQUIRE EXTRAORDINARILY HIGH LEVELS OF QUALITY AND/OR RELIABILITY, AND/OR A MALFUNCTION OR FAILURE OF WHICH MAY CAUSE LOSS OF HUMAN LIFE, BODILY INJURY, SERIOUS PROPERTY DAMAGE AND/OR SERIOUS PUBLIC IMPACT ("UNINTENDED USE").** Except for specific applications as expressly stated in this document, Unintended Use includes, without limitation, equipment used in nuclear facilities, equipment used in the aerospace industry, medical equipment, equipment used for automobiles, trains, ships and other transportation, traffic signaling equipment, equipment used to control combustions or explosions, safety devices, elevators and escalators, devices related to electric power, and equipment used in finance-related fields. **IF YOU USE PRODUCT FOR UNINTENDED USE, TOSHIBA ASSUMES NO LIABILITY FOR PRODUCT.** For details, please contact your TOSHIBA sales representative.
- ▶ Do not disassemble, analyze, reverse-engineer, alter, modify, translate or copy Product, whether in whole or in part.
- ▶ Product shall not be used for or incorporated into any products or systems whose manufacture, use, or sale is prohibited under any applicable laws or regulations.
- ▶ The information contained herein is presented only as guidance for Product use. No responsibility is assumed by TOSHIBA for any infringement of patents or any other intellectual property rights of third parties that may result from the use of Product. No license to any intellectual property right is granted by this document, whether express or implied, by estoppel or otherwise.
- ▶ **ABSENT A WRITTEN SIGNED AGREEMENT, EXCEPT AS PROVIDED IN THE RELEVANT TERMS AND CONDITIONS OF SALE FOR PRODUCT, AND TO THE MAXIMUM EXTENT ALLOWABLE BY LAW, TOSHIBA (1) ASSUMES NO LIABILITY WHATSOEVER, INCLUDING WITHOUT LIMITATION, INDIRECT, CONSEQUENTIAL, SPECIAL, OR INCIDENTAL DAMAGES OR LOSS, INCLUDING WITHOUT LIMITATION, LOSS OF PROFITS, LOSS OF OPPORTUNITIES, BUSINESS INTERRUPTION AND LOSS OF DATA, AND (2) DISCLAIMS ANY AND ALL EXPRESS OR IMPLIED WARRANTIES AND CONDITIONS RELATED TO SALE, USE OF PRODUCT, OR INFORMATION, INCLUDING WARRANTIES OR CONDITIONS OF MERCHANTABILITY, FITNESS FOR A PARTICULAR PURPOSE, ACCURACY OF INFORMATION, OR NONINFRINGEMENT.**
- ▶ GaAs (Gallium Arsenide) is used in Product. GaAs is harmful to humans if consumed or absorbed, whether in the form of dust or vapor. Handle with care and do not break, cut, crush, grind, dissolve chemically or otherwise expose GaAs in Product.
- ▶ Do not use or otherwise make available Product or related software or technology for any military purposes, including without limitation, for the design, development, use, stockpiling or manufacturing of nuclear, chemical, or biological weapons or missile technology products (mass destruction weapons). Product and related software and technology may be controlled under the applicable export laws and regulations including, without limitation, the Japanese Foreign Exchange and Foreign Trade Law and the U.S. Export Administration Regulations. Export and re-export of Product or related software or technology are strictly prohibited except in compliance with all applicable export laws and regulations.
- ▶ Please contact your TOSHIBA sales representative for details as to environmental matters such as the RoHS compatibility of Product. Please use Product in compliance with all applicable laws and regulations that regulate the inclusion or use of controlled substances, including without limitation, the EU RoHS Directive. **TOSHIBA ASSUMES NO LIABILITY FOR DAMAGES OR LOSSES OCCURRING AS A RESULT OF NONCOMPLIANCE WITH APPLICABLE LAWS AND REGULATIONS.**

TOSHIBA

TOSHIBA CORPORATION Semiconductor & Storage Products Company

©2015 TOSHIBA CORPORATION

Previous edition: BCE0034K

X-ON Electronics

Largest Supplier of Electrical and Electronic Components

Click to view similar products for [Logic Output Opto-couplers](#) category:

Click to view products by [Toshiba](#) manufacturer:

Other Similar products are found below :

[CPC1590P](#) [TLP705A\(F\)](#) [TLP700A\(F\)](#) [FOD3150](#) [TLP2348](#) [VO3120-X001](#) [ACPL-W343-560E](#) [ACPL-W340-560E](#) [H11L2S\(TA\)-V](#) [ACPL-P347-500E](#) [ACPL-P347-560E](#) [ACNT-H343-500E](#) [TLP5772H\(TP4,E](#) [TLP5772H\(TP,E](#) [TLP5771H\(TP4,E](#) [TLP5774H\(TP,E](#) [TLP5772H\(D4,E](#) [TLP5772H\(LF4,E](#) [TLP5771H\(D4,E](#) [TLP5774H\(D4,E](#) [TLP5771H\(E](#) [TLP5772H\(D4LF4,E](#) [TLP5774H\(LF4,E](#) [TLP5771H\(D4LF4,E](#) [TLP5771H\(LF4,E](#) [TLP5774H\(E](#) [H11L1S\(TA\)](#) [H11L3SR2M](#) [HCPL-0302-000E](#) [HCPL3700SD](#) [TLP155E\(TPL,E\)](#) [TLP2345\(E\(T](#) [TLP2348\(E\(T](#) [TLP350H\(F\)](#) [TLP701AF\(F\)](#) [MID400](#) [TLP351H\(F\)](#) [TLP5214\(TP,E\(O](#) [TLP5702\(TP,E](#) [ACPL-W343-500E](#) [TLP351H\(TP1,F\)](#) [FOD3120SDV](#) [FOD8160](#) [FOD3184TSR2V](#) [6N140A/883B](#) [HCPL-0466-500E](#) [HCPL-6750](#) [TLP700AF\(F\)](#) [TLP152\(TPL,E](#) [HCPL-5730](#)