

TLP2301

1. Applications

- Industrial Inverters
- Communications Equipment
- Home Electric Appliances

2. General

The Toshiba TLP2301 consists of a high-speed detector based on the photo-transistor optically coupled to GaAs infrared emitting diodes. It is housed in the SO6 package. The TLP2301 has realized the early switching characteristics by several k Ω resistance. The TLP2301 correspond to the transmission rate of 20 kbps, and has become a product which fills between a general-purpose transistor coupler and IC couplers corresponding to 1 Mbps.

3. Features

- (1) Collector-emitter voltage: 40 V (min)
- (2) Current transfer ratio: 50% (min) (@ $I_F = 1$ mA, $V_{CE} = 5$ V)
Rank GB: 100% (min) (@ $I_F = 1$ mA, $V_{CE} = 5$ V)
- (3) Isolation voltage: 3750 Vrms (min)
- (4) Propagation delay time: $t_{pHL} = 30$ μ s (max), $t_{pLH} = 30$ μ s (max) @ $I_F = 1$ mA, $R_L = 10$ k Ω , $T_a = 25$ $^{\circ}$ C
- (5) Operating temperature: -55 to 125 $^{\circ}$ C
- (6) Safety standards

UL-approved: UL1577, File No.E67349

cUL-approved: CSA Component Acceptance Service No.5A File No.E67349

VDE-approved: EN60747-5-5, EN60065 or EN60950-1 (**Note 1**)

: EN62368-1 (Pending) (**Note 1**)

CQC-approved: GB4943.1, GB8898 Japan and Thailand Factory



仅适用于海拔 2000m 以下地区安全使用

Note 1: When a VDE approved type is needed, please designate the **Option (V4)**.

Start of commercial production

2013-03

4. Packaging and Pin Assignment

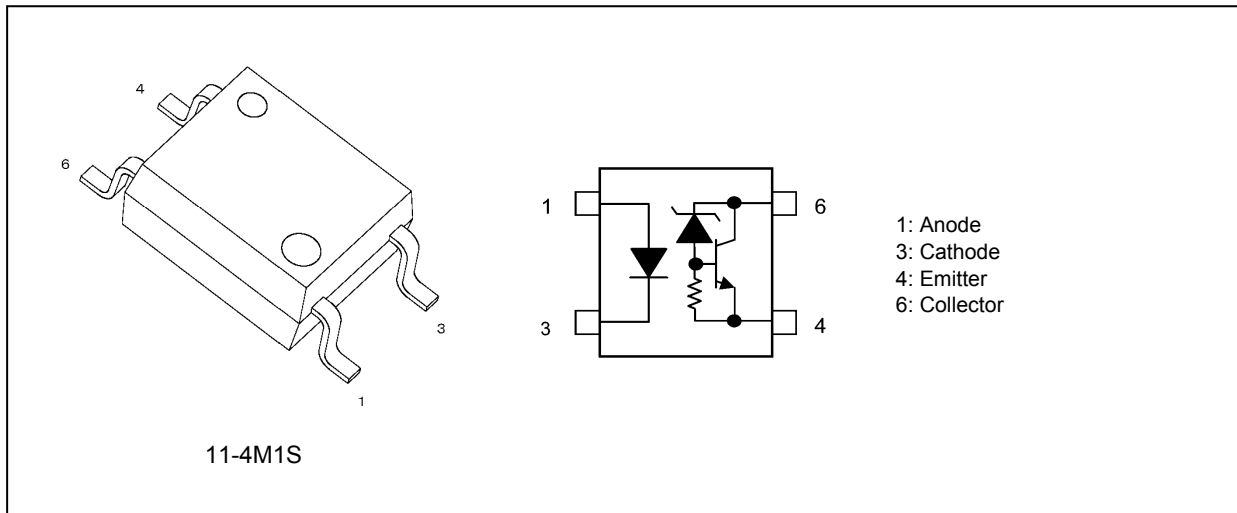

5. Principle of Operation

5.1. Mechanical Parameters

| Characteristics | Min | Unit |
|------------------------------|-----|------|
| Creepage distances | 5.0 | mm |
| Clearance | 5.0 | |
| Internal isolation thickness | 0.4 | |

6. Absolute Maximum Ratings (Note) (Unless otherwise specified, $T_a = 25\text{ °C}$)

| | Characteristics | Symbol | Note | Rating | Unit |
|----------|--|-------------------------|----------|------------|-------|
| LED | Input forward current | I_F | | 50 | mA |
| | Input forward current derating ($T_a \geq 90\text{ °C}$) | $\Delta I_F/\Delta T_a$ | | -1.11 | mA/°C |
| | Input forward current (pulsed) | I_{FP} | (Note 1) | 1 | A |
| | Input reverse voltage | V_R | | 5 | V |
| | Input power dissipation | P_D | | 100 | mW |
| | Input power dissipation derating ($T_a \geq 90\text{ °C}$) | $\Delta P_D/\Delta T_a$ | | -2.8 | mW/°C |
| | Junction temperature | T_j | | 135 | °C |
| Detector | Collector-emitter voltage | V_{CEO} | | 40 | V |
| | Emitter-collector voltage | V_{ECO} | | 7 | V |
| | Collector current | I_C | | 50 | mA |
| | Collector power dissipation | P_C | | 150 | mW |
| | Collector power dissipation derating ($T_a \geq 25\text{ °C}$) | $\Delta P_C/\Delta T_a$ | | -1.35 | mW/°C |
| | Junction temperature | T_j | | 135 | °C |
| Common | Operating temperature | T_{opr} | | -55 to 125 | |
| | Storage temperature | T_{stg} | | -55 to 125 | |
| | Lead soldering temperature (10 s) | T_{sol} | | 260 | °C |
| | Total power dissipation | P_T | | 200 | mW |
| Common | Isolation voltage AC, 60 s, R.H. $\leq 60\%$ | BV_S | (Note 2) | 3750 | Vrms |

Note: Using continuously under heavy loads (e.g. the application of high temperature/current/voltage and the significant change in temperature, etc.) may cause this product to decrease in the reliability significantly even if the operating conditions (i.e. operating temperature/current/voltage, etc.) are within the absolute maximum ratings.

Please design the appropriate reliability upon reviewing the Toshiba Semiconductor Reliability Handbook ("Handling Precautions"/"Derating Concept and Methods") and individual reliability data (i.e. reliability test report and estimated failure rate, etc).

Note 1: Pulse width (PW) $\leq 0.1\text{ ms}$, $f = 100\text{ Hz}$

Note 2: This device is considered as a two-terminal device: Pins 1 and 3 are shorted together, and pins 4 and 6 are shorted together.

7. Electrical Characteristics (Unless otherwise specified, $T_a = 25\text{ }^\circ\text{C}$)

| | Characteristics | Symbol | Note | Test Condition | Min | Typ. | Max | Unit |
|-------------------------------|-------------------------------------|---------------|------------------------------------|--|-----|------|------|---------------|
| LED | Input forward voltage | V_F | | $I_F = 10\text{ mA}$ | 1.1 | 1.25 | 1.4 | V |
| | Input reverse current | I_R | | $V_R = 5\text{ V}$ | — | — | 10 | μA |
| | Input capacitance | C_t | | $V = 0\text{ V}, f = 1\text{ MHz}$ | — | 30 | — | pF |
| Detector | Collector-emitter breakdown voltage | $V_{(BR)CEO}$ | | $I_C = 0.1\text{ mA}$ | 40 | — | — | V |
| | Emitter-collector breakdown voltage | $V_{(BR)ECO}$ | | $I_E = 0.1\text{ mA}$ | 7 | — | — | V |
| | Dark Current | I_{DARK} | | $V_{CE} = 40\text{ V}$ | — | 0.01 | 0.08 | μA |
| | | | | $V_{CE} = 40\text{ V}, T_a = 85\text{ }^\circ\text{C}$ | — | 2 | 50 | μA |
| Collector-emitter capacitance | C_{CE} | | $V = 0\text{ V}, f = 1\text{ MHz}$ | — | 10 | — | pF | |

8. Coupled Electrical Characteristics (Unless otherwise specified, $T_a = 25\text{ }^\circ\text{C}$)

| | Characteristics | Symbol | Note | Test Condition | Min | Typ. | Max | Unit |
|--------------------------------------|------------------|----------|------|--|-----|------|-----|---------------|
| Current transfer ratio | I_C/I_F | (Note 1) | | $I_F = 1\text{ mA}, V_{CE} = 5\text{ V}$ | 50 | — | 600 | % |
| | | | | $I_F = 1\text{ mA}, V_{CE} = 5\text{ V}, \text{Rank GB}$ | 100 | — | 600 | |
| Saturated current transfer ratio | $I_C/I_{F(sat)}$ | | | $I_F = 1\text{ mA}, V_{CE} = 0.3\text{ V}$ | — | 100 | — | % |
| | | | | $I_F = 1\text{ mA}, V_{CE} = 0.3\text{ V}, \text{Rank GB}$ | 50 | — | — | |
| Collector-emitter saturation voltage | $V_{CE(sat)}$ | | | $I_C = 2.4\text{ mA}, I_F = 8\text{ mA}$ | — | — | 0.3 | V |
| | | | | $I_C = 0.2\text{ mA}, I_F = 1\text{ mA}$ | — | 0.2 | — | |
| | | | | $I_C = 0.2\text{ mA}, I_F = 1\text{ mA}, \text{Rank GB}$ | — | — | 0.3 | |
| OFF-state collector current | $I_{C(off)}$ | | | $V_F = 0.7\text{ V}, V_{CE} = 40\text{ V}$ | — | 1 | 10 | μA |

Note1: See Table 9.1 for current transfer ratio.

Table 9.1 Current Transfer Ratio (CTR) Rank (Note) (Unless otherwise specified, $T_a = 25\text{ }^\circ\text{C}$)

| Rank | Test Condition | Current transfer ratio I_C/I_F Min | Current transfer ratio I_C/I_F Max | Unit |
|------|--|--|--|------|
| None | $I_F = 1\text{ mA}, V_{CE} = 5\text{ V}$ | 50 | 600 | % |
| GB | | 100 | 600 | |

Note: Specify both the part number and a rank in this format when ordering.

Example: TLP2301(GB)

For safety standard certification, however, specify the part number alone.

Example: TLP2301(GB,E: TLP2301)

9. Isolation Characteristics (Unless otherwise specified, $T_a = 25\text{ }^\circ\text{C}$)

| | Characteristics | Symbol | Note | Test Condition | Min | Typ. | Max | Unit |
|-------------------------------------|-----------------|----------|------|---|--------------------|-----------|-----|----------|
| Total capacitance (input to output) | C_S | (Note 1) | | $V_S = 0\text{ V}, f = 1\text{ MHz}$ | — | 0.8 | — | pF |
| Isolation resistance | R_S | (Note 1) | | $V_S = 500\text{ V}, \text{R.H.} \leq 60\%$ | 1×10^{12} | 10^{14} | — | Ω |
| Isolation voltage | BV_S | (Note 1) | | AC, 60 s | 3750 | — | — | Vrms |
| | | | | AC, 1 s in oil | — | 10000 | — | Vrms |
| | | | | DC, 60 s in oil | — | 10000 | — | Vdc |

Note 1: This device is considered as a two-terminal device: 1 and 3 are shorted together, and pins 4 and 6 are shorted together.

10. Switching Characteristics (Unless otherwise specified, $T_a = 25\text{ }^\circ\text{C}$)

| Characteristics | Symbol | Note | Test Condition | Min | Typ. | Max | Unit |
|------------------------------|-----------|------|--|-----|------|-----|---------------|
| Propagation delay time (H/L) | t_{pHL} | | See figure 10.1 $V_{CC} = 5\text{ V}$, $I_F = 1\text{ mA}$, $R_L = 10\text{ k}\Omega$ | — | 15 | 30 | μs |
| Propagation delay time (L/H) | t_{pLH} | | See figure 10.1 $V_{CC} = 5\text{ V}$, $I_F = 1\text{ mA}$, $R_L = 10\text{ k}\Omega$ | — | 8 | 30 | μs |

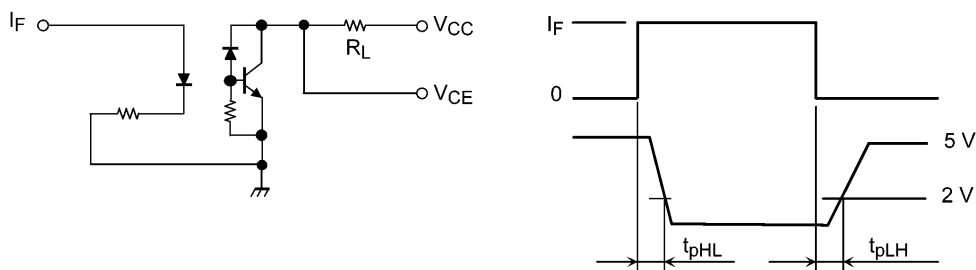

Fig. 10.1 Propagation delay Time Test Circuit and Waveform

11. Characteristics Curves (Note)

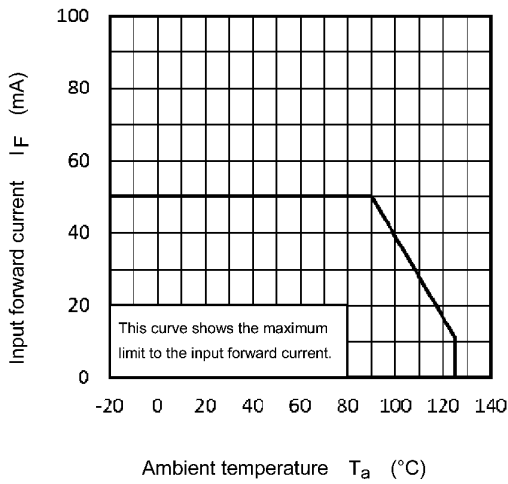

Fig. 11.1 $I_F - T_a$

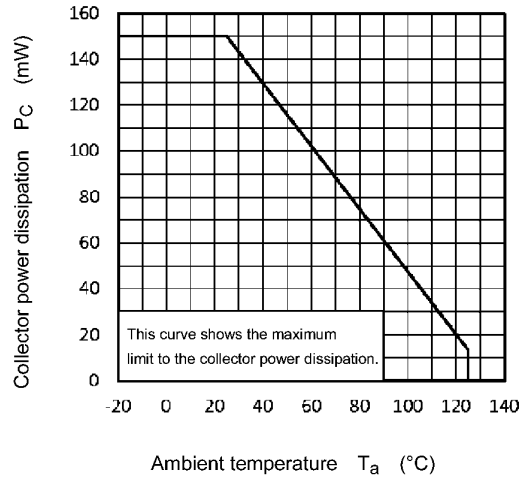

Fig. 11.2 $P_C - T_a$

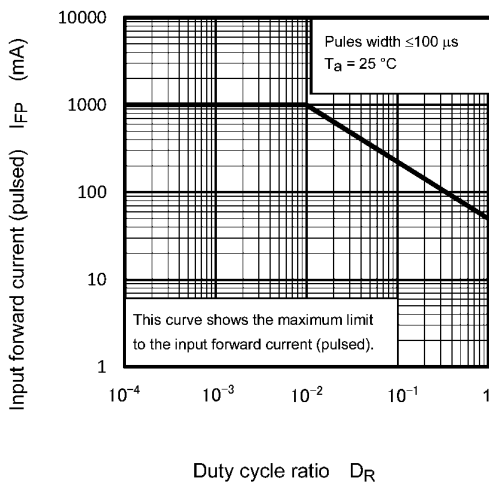

Fig. 11.3 $I_{FP} - D_R$

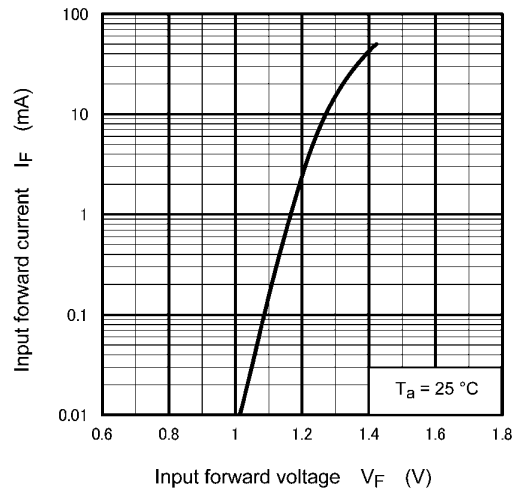

Fig. 11.4 $I_F - V_F$

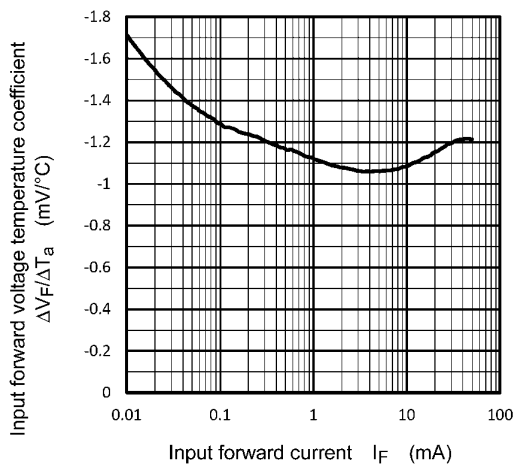

Fig. 11.5 $\Delta V_F / \Delta T_a - I_F$

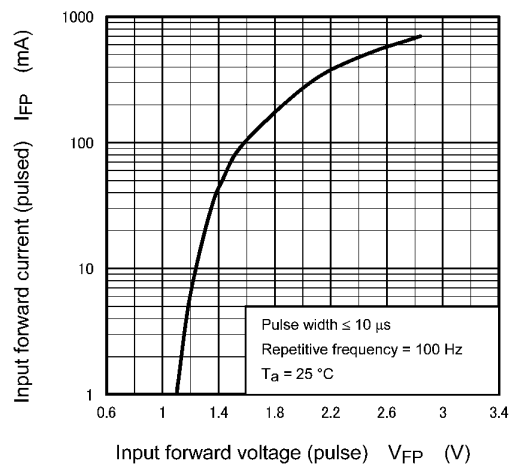
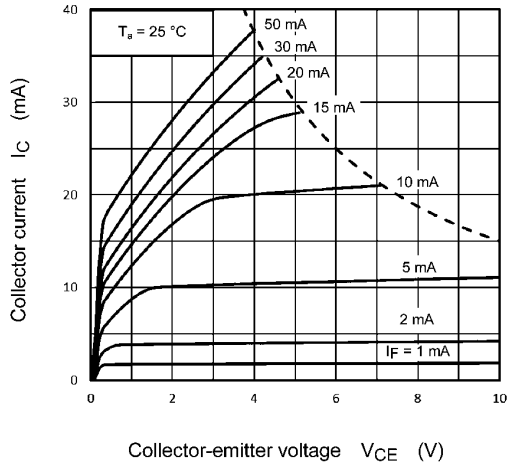
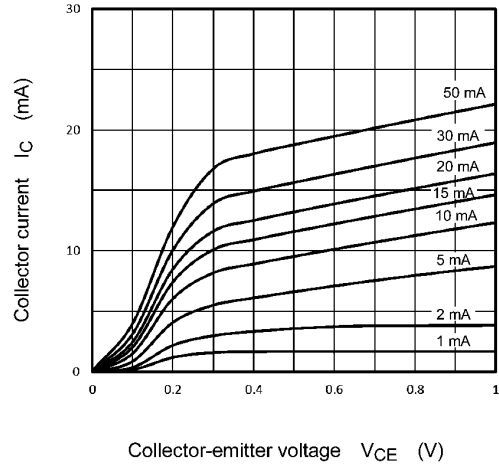

Fig. 11.6 $I_{FP} - V_{FP}$



Collector-emitter voltage V_{CE} (V)
Fig. 11.7 $I_C - V_{CE}$



Collector-emitter voltage V_{CE} (V)
Fig. 11.8 $I_C - V_{CE}$

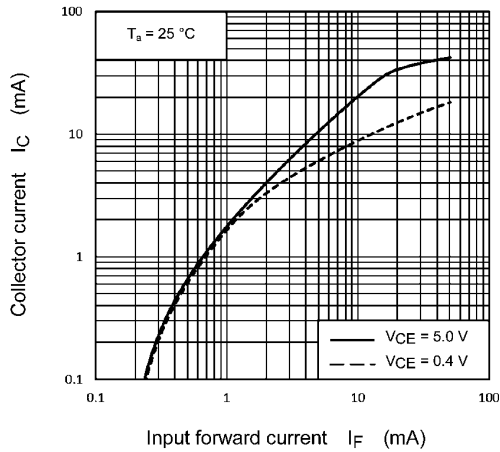

Input forward current I_F (mA)
Fig. 11.9 $I_C - I_F$

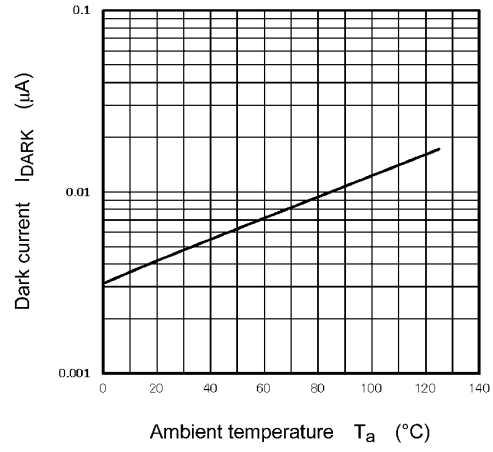

Ambient temperature T_a (°C)
Fig. 11.10 $I_{DARK} - T_a$

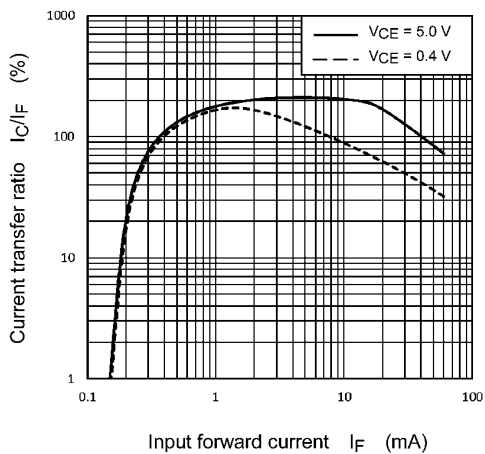

Input forward current I_F (mA)
Fig. 11.11 $I_C/I_F - I_F$

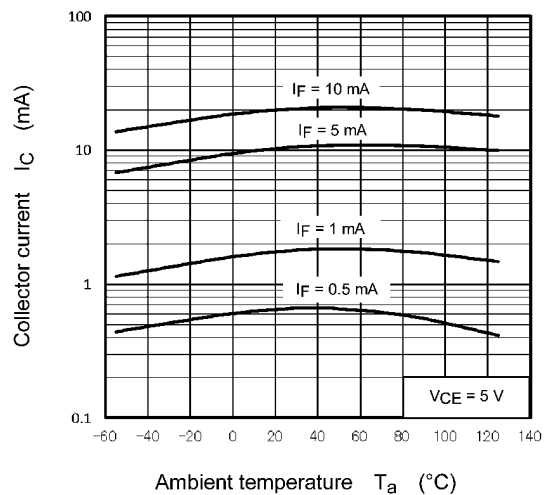

Ambient temperature T_a (°C)
Fig. 11.12 $I_C - T_a$

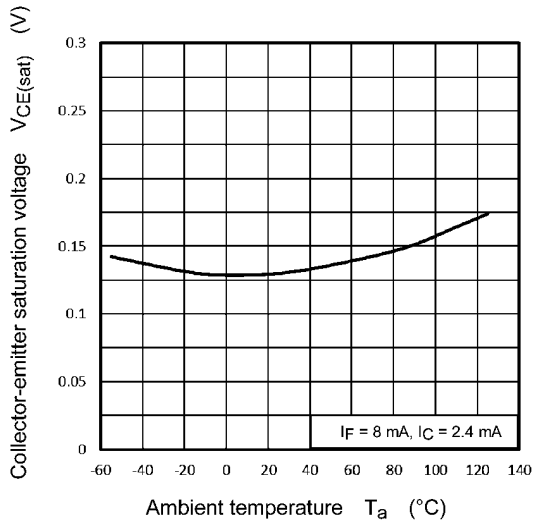

Fig. 11.13 $V_{CE(sat)} - T_a$

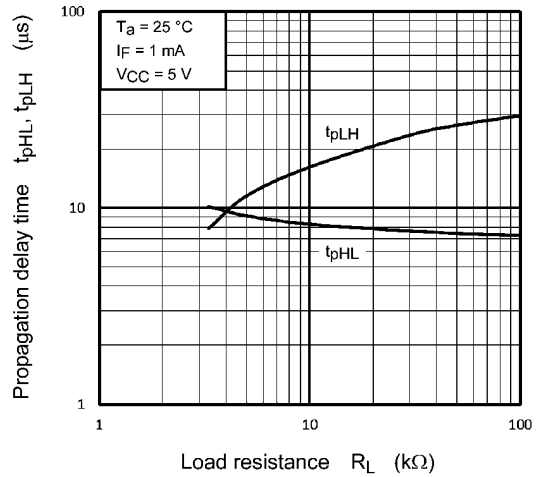

Fig. 11.14 $t_{pHL}, t_{pLH} - R_L$

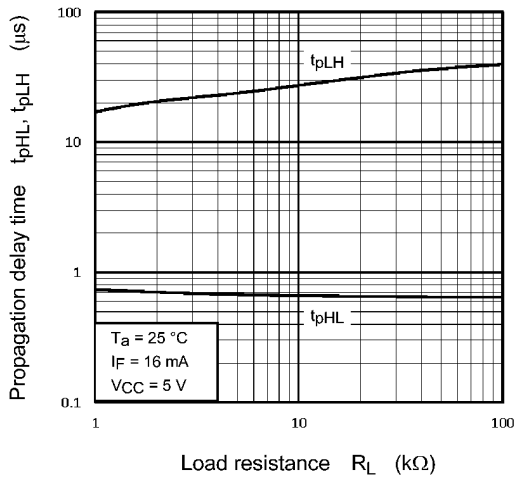

Fig. 11.15 $t_{pHL}, t_{pLH} - R_L$

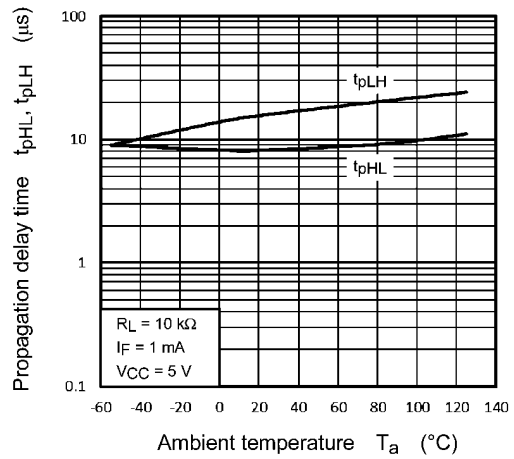

Fig. 11.16 $t_{pHL}, t_{pLH} - T_a$

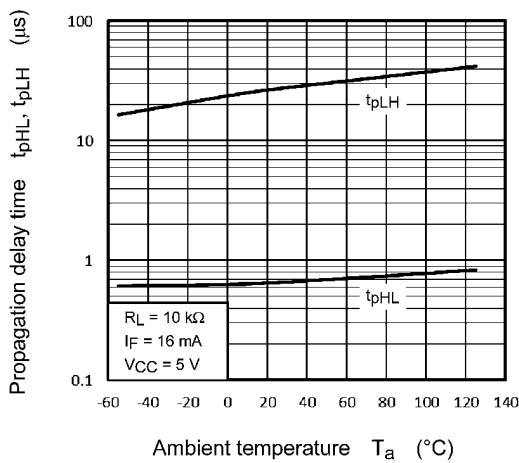

Fig. 11.17 $t_{pHL}, t_{pLH} - T_a$

Note: The above characteristics curves are presented for reference only and not guaranteed by production test, unless otherwise noted.

12. Soldering and Storage

12.1. Precautions for Soldering

The soldering temperature should be controlled as closely as possible to the conditions shown below, irrespective of whether a soldering iron or a reflow soldering method is used.

- When using soldering reflow.

The soldering temperature profile is based on the package surface temperature.

(See the figure shown below, which is based on the package surface temperature.)

Reflow soldering must be performed once or twice.

The mounting should be completed with the interval from the first to the last mountings being 2 weeks.

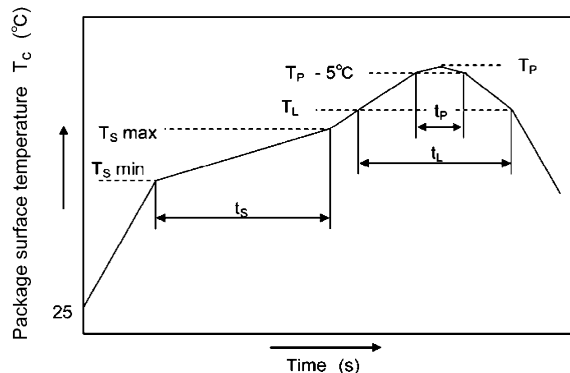

| | Symbol | Min | Max | Unit |
|--|--------|-----|-----|------|
| Preheat temperature | T_S | 150 | 200 | °C |
| Preheat time | t_S | 60 | 120 | s |
| Ramp-up rate (T_L to T_P) | | | 3 | °C/s |
| Liquidus temperature | T_L | 217 | | °C |
| Time above T_L | t_L | 60 | 150 | s |
| Peak temperature | T_P | | 260 | °C |
| Time during which T_c is between ($T_P - 5$) and T_P | t_p | | 30 | s |
| Ramp-down rate (T_P to T_L) | | | 6 | °C/s |

**An Example of a Temperature Profile
When Lead(Pb)-Free Solder Is Used**

- When using soldering flow
Preheat the device at a temperature of 150 °C (package surface temperature) for 60 to 120 seconds.
Mounting condition of 260 °C within 10 seconds is recommended.
Flow soldering must be performed once.
- When using soldering Iron
Complete soldering within 10 seconds for lead temperature not exceeding 260 °C or within 3 seconds not exceeding 350 °C
Heating by soldering iron must be done only once per lead.

12.2. Precautions for General Storage

- Avoid storage locations where devices may be exposed to moisture or direct sunlight.
- Follow the precautions printed on the packing label of the device for transportation and storage.
- Keep the storage location temperature and humidity within a range of 5 °C to 35 °C and 45 % to 75 %, respectively.
- Do not store the products in locations with poisonous gases (especially corrosive gases) or in dusty conditions.
- Store the products in locations with minimal temperature fluctuations. Rapid temperature changes during storage can cause condensation, resulting in lead oxidation or corrosion, which will deteriorate the solderability of the leads.
- When restoring devices after removal from their packing, use anti-static containers.
- Do not allow loads to be applied directly to devices while they are in storage.
- If devices have been stored for more than two years under normal storage conditions, it is recommended that you check the leads for ease of soldering prior to use.

13. Marking

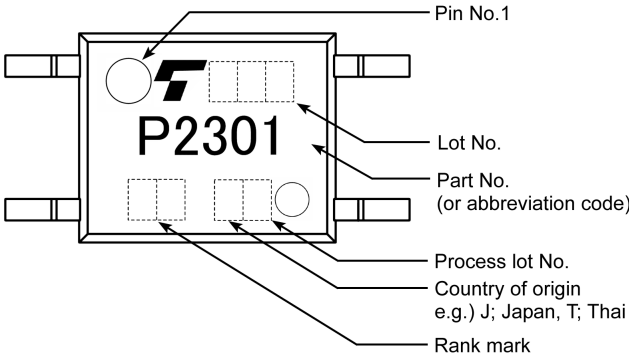

Package Dimensions

Unit: mm

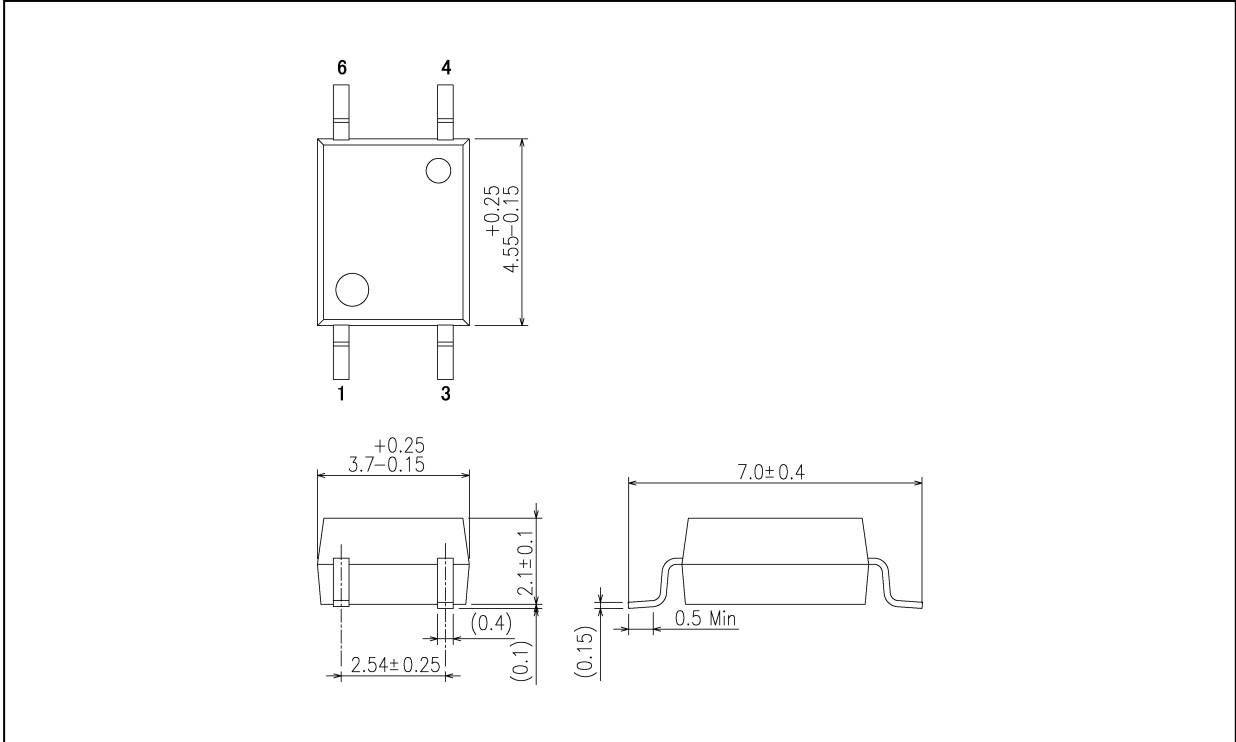

Weight: 0.08 g (typ.)

| Package Name(s) |
|------------------|
| TOSHIBA: 11-4M1S |

RESTRICTIONS ON PRODUCT USE

Toshiba Corporation and its subsidiaries and affiliates are collectively referred to as "TOSHIBA".

Hardware, software and systems described in this document are collectively referred to as "Product".

- TOSHIBA reserves the right to make changes to the information in this document and related Product without notice.
- This document and any information herein may not be reproduced without prior written permission from TOSHIBA. Even with TOSHIBA's written permission, reproduction is permissible only if reproduction is without alteration/omission.
- Though TOSHIBA works continually to improve Product's quality and reliability, Product can malfunction or fail. Customers are responsible for complying with safety standards and for providing adequate designs and safeguards for their hardware, software and systems which minimize risk and avoid situations in which a malfunction or failure of Product could cause loss of human life, bodily injury or damage to property, including data loss or corruption. Before customers use the Product, create designs including the Product, or incorporate the Product into their own applications, customers must also refer to and comply with (a) the latest versions of all relevant TOSHIBA information, including without limitation, this document, the specifications, the data sheets and application notes for Product and the precautions and conditions set forth in the "TOSHIBA Semiconductor Reliability Handbook" and (b) the instructions for the application with which the Product will be used with or for. Customers are solely responsible for all aspects of their own product design or applications, including but not limited to (a) determining the appropriateness of the use of this Product in such design or applications; (b) evaluating and determining the applicability of any information contained in this document, or in charts, diagrams, programs, algorithms, sample application circuits, or any other referenced documents; and (c) validating all operating parameters for such designs and applications. **TOSHIBA ASSUMES NO LIABILITY FOR CUSTOMERS' PRODUCT DESIGN OR APPLICATIONS.**
- **PRODUCT IS NEITHER INTENDED NOR WARRANTED FOR USE IN EQUIPMENTS OR SYSTEMS THAT REQUIRE EXTRAORDINARILY HIGH LEVELS OF QUALITY AND/OR RELIABILITY, AND/OR A MALFUNCTION OR FAILURE OF WHICH MAY CAUSE LOSS OF HUMAN LIFE, BODILY INJURY, SERIOUS PROPERTY DAMAGE AND/OR SERIOUS PUBLIC IMPACT ("UNINTENDED USE").** Except for specific applications as expressly stated in this document, Unintended Use includes, without limitation, equipment used in nuclear facilities, equipment used in the aerospace industry, medical equipment, equipment used for automobiles, trains, ships and other transportation, traffic signaling equipment, equipment used to control combustions or explosions, safety devices, elevators and escalators, devices related to electric power, and equipment used in finance-related fields. **IF YOU USE PRODUCT FOR UNINTENDED USE, TOSHIBA ASSUMES NO LIABILITY FOR PRODUCT.** For details, please contact your TOSHIBA sales representative.
- Do not disassemble, analyze, reverse-engineer, alter, modify, translate or copy Product, whether in whole or in part.
- Product shall not be used for or incorporated into any products or systems whose manufacture, use, or sale is prohibited under any applicable laws or regulations.
- The information contained herein is presented only as guidance for Product use. No responsibility is assumed by TOSHIBA for any infringement of patents or any other intellectual property rights of third parties that may result from the use of Product. No license to any intellectual property right is granted by this document, whether express or implied, by estoppel or otherwise.
- **ABSENT A WRITTEN SIGNED AGREEMENT, EXCEPT AS PROVIDED IN THE RELEVANT TERMS AND CONDITIONS OF SALE FOR PRODUCT, AND TO THE MAXIMUM EXTENT ALLOWABLE BY LAW, TOSHIBA (1) ASSUMES NO LIABILITY WHATSOEVER, INCLUDING WITHOUT LIMITATION, INDIRECT, CONSEQUENTIAL, SPECIAL, OR INCIDENTAL DAMAGES OR LOSS, INCLUDING WITHOUT LIMITATION, LOSS OF PROFITS, LOSS OF OPPORTUNITIES, BUSINESS INTERRUPTION AND LOSS OF DATA, AND (2) DISCLAIMS ANY AND ALL EXPRESS OR IMPLIED WARRANTIES AND CONDITIONS RELATED TO SALE, USE OF PRODUCT, OR INFORMATION, INCLUDING WARRANTIES OR CONDITIONS OF MERCHANTABILITY, FITNESS FOR A PARTICULAR PURPOSE, ACCURACY OF INFORMATION, OR NONINFRINGEMENT.**
- GaAs (Gallium Arsenide) is used in Product. GaAs is harmful to humans if consumed or absorbed, whether in the form of dust or vapor. Handle with care and do not break, cut, crush, grind, dissolve chemically or otherwise expose GaAs in Product.
- Do not use or otherwise make available Product or related software or technology for any military purposes, including without limitation, for the design, development, use, stockpiling or manufacturing of nuclear, chemical, or biological weapons or missile technology products (mass destruction weapons). Product and related software and technology may be controlled under the applicable export laws and regulations including, without limitation, the Japanese Foreign Exchange and Foreign Trade Law and the U.S. Export Administration Regulations. Export and re-export of Product or related software or technology are strictly prohibited except in compliance with all applicable export laws and regulations.
- Please contact your TOSHIBA sales representative for details as to environmental matters such as the RoHS compatibility of Product. Please use Product in compliance with all applicable laws and regulations that regulate the inclusion or use of controlled substances, including without limitation, the EU RoHS Directive. **TOSHIBA ASSUMES NO LIABILITY FOR DAMAGES OR LOSSES OCCURRING AS A RESULT OF NONCOMPLIANCE WITH APPLICABLE LAWS AND REGULATIONS.**

X-ON Electronics

Largest Supplier of Electrical and Electronic Components

Click to view similar products for [High Speed Optocouplers](#) category:

Click to view products by [Toshiba](#) manufacturer:

Other Similar products are found below :

[6N136F](#) [HCPL-2201-300](#) [JAN4N24](#) [610737H](#) [HCPL2630M](#) [HCPL2630SM](#) [PS9817A-1-F3-AX](#) [PS9821-2-F3-AX](#) [TLP2766A\(E](#)
[TLP2766A\(LF4,E](#) [PS9121-F3-AX](#) [PS9123-F3-AX](#) [TLP5774H\(TP4,E](#) [TLP5771H\(TP,E](#) [TLP2304\(E\(O](#) [054279X](#) [HCPL2631SD](#) [HCPL-2730-](#)
[500E](#) [TLP118\(TPL,E\)](#) [TLP2309\(E\(T](#) [TLP2366\(TPL,E](#) [TLP521-2XGB](#) [TLP621-2XGB](#) [JANTXV4N24U](#) [8102802PC](#) [5962-8767902XA](#)
[5962-8876801XA](#) [5962-8957101PA](#) [SFH6318T](#) [6N135-300E](#) [TIL198](#) [TLP104\(TPR,E\)](#) [TLP2309\(TPL,E\)](#) [TLP2355\(TPL,E](#) [TLP2358\(E\)](#)
[TLP521-4GR](#) [TLP521-4XGB](#) [TLP621XSM](#) [5962-8876801PA](#) [IS281-4GB](#) [IS2805-4](#) [IS181GR](#) [ICPL2630](#) [ICPL2531](#) [ICPL2601](#) [ICPL2530](#)
[TLP2301](#) [TLP2301\(E\(T](#) [TLP2362\(TPR,E](#) [FOD0710R2](#)