

# TLP2362

## 1. Applications

- Factory Automation (FA)
- Plasma Display Panels (PDPs)
- Measuring Instruments

## 2. General

The Toshiba TLP2362 consists of a high-output infrared LED coupled with integrated high gain, high-speed photodetectors. The TLP2362 guarantees operation at up to 125 °C and on supplies from 2.7 V to 5.5 V. It is housed in the SO6 package. The TLP2362 has an internal Faraday shield that provides a guaranteed common-mode transient immunity of  $\pm 20$  kV/ $\mu$ s.

## 3. Features

- (1) Inverter logic type (open collector output)
- (2) Package: SO6
- (3) Operating temperature: -40 to 125 °C
- (4) Supply voltage: 2.7 to 5.5 V
- (5) Data transfer rate: 10 MBd (typ.) (NRZ)
- (6) Threshold input current: 5.0 mA (max)
- (7) Supply current: 4 mA (max)
- (8) Common-mode transient immunity:  $\pm 20$  kV/ $\mu$ s (min)
- (9) Isolation voltage: 3750 Vrms (min)
- (10) Safety standards

UL-recognized: UL 1577, File No.E67349

cUL-recognized: CSA Component Acceptance Service No.5A File No.E67349

VDE-approved: EN 60747-5-5, EN 62368-1 (**Note 1**)

CQC-approved: GB4943.1, GB8898 Thailand Factory



仅适用于海拔 2000m 以下地区安全使用

Note 1: When a VDE approved type is needed, please designate the **Option (V4)**.

## 4. Packaging and Pin Assignment

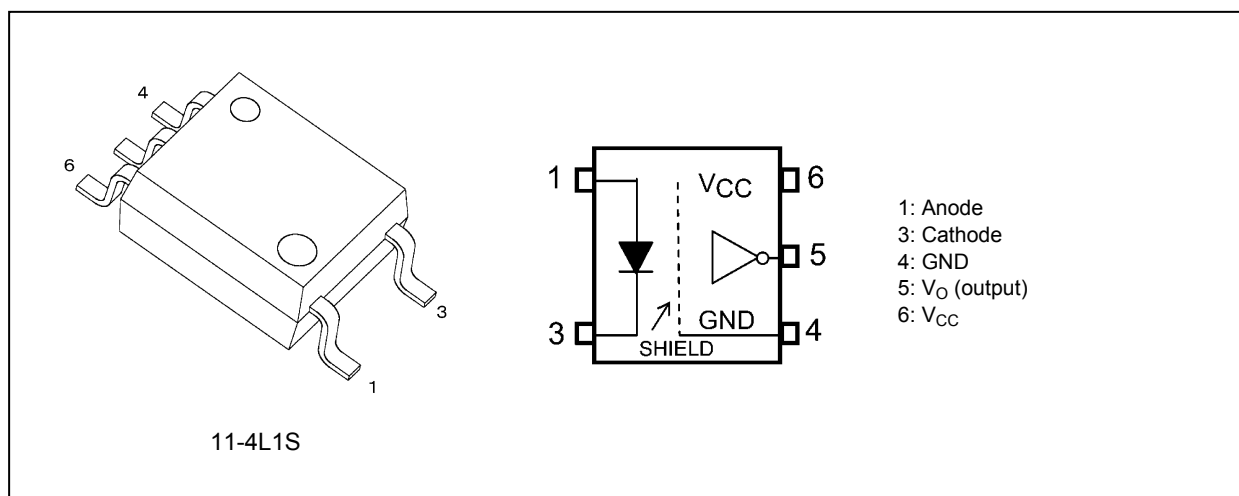

Start of commercial production

2011-05

## 5. Internal Equivalent Circuit (Note)

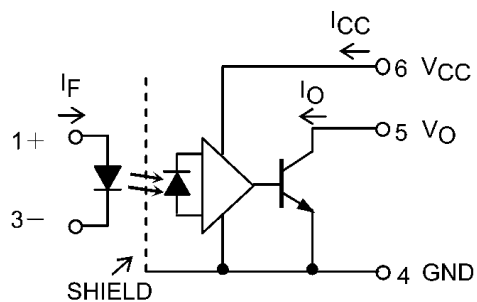

Note: A 0.1- $\mu$ F bypass capacitor must be connected between pin 6 and pin 4.

## 6. Principle of Operation

### 6.1. Truth Table

Input	LED	Output
H	ON	L
L	OFF	H

### 6.2. Mechanical Parameters

Characteristics	Min	Unit
Creepage distances	5.0	mm
Clearance distances	5.0	
Internal isolation thickness	0.4	

## 7. Absolute Maximum Ratings (Note) (Unless otherwise specified, $T_a = 25\text{ }^\circ\text{C}$ )

	Characteristics	Symbol	Note	Rating	Unit
LED	Input forward current	$I_F$		25	mA
	Input forward current derating ( $T_a \geq 110\text{ }^\circ\text{C}$ )	$\Delta I_F/\Delta T_a$		-0.67	mA/°C
	Input forward current (pulsed)	$I_{FP}$	(Note 1)	40	mA
	Input forward current derating (pulsed) ( $T_a \geq 110\text{ }^\circ\text{C}$ )	$\Delta I_{FP}/\Delta T_a$		-1.0	mA/°C
	Peak transient input forward current	$I_{FPT}$	(Note 2)	1	A
	Peak transient input forward current derating ( $T_a \geq 110\text{ }^\circ\text{C}$ )	$\Delta I_{FPT}/\Delta T_a$		-25	mA/°C
	Input power dissipation	$P_D$		40	mW
	Input power dissipation derating ( $T_a \geq 110\text{ }^\circ\text{C}$ )	$\Delta P_D/\Delta T_a$		-1.0	mW/°C
	Input reverse voltage	$V_R$		5	V
Detector	Output current	$I_O$		25	mA
	Output voltage	$V_O$		6	V
	Supply voltage	$V_{CC}$		6	
	Output power dissipation	$P_O$		60	mW
	Output power dissipation derating ( $T_a \geq 110\text{ }^\circ\text{C}$ )	$\Delta P_O/\Delta T_a$		-1.5	mW/°C
Common	Operating temperature	$T_{opr}$		-40 to 125	°C
	Storage temperature	$T_{stg}$		-55 to 125	
	Lead soldering temperature (10 s)	$T_{sol}$		260	
	Isolation voltage (AC, 60 s, R.H. $\leq 60\%$ )	$BV_S$	(Note 3)	3750	Vrms

Note: Using continuously under heavy loads (e.g. the application of high temperature/current/voltage and the significant change in temperature, etc.) may cause this product to decrease in the reliability significantly even if the operating conditions (i.e. operating temperature/current/voltage, etc.) are within the absolute maximum ratings.

Please design the appropriate reliability upon reviewing the Toshiba Semiconductor Reliability Handbook ("Handling Precautions"/"Derating Concept and Methods") and individual reliability data (i.e. reliability test report and estimated failure rate, etc.).

Note 1: Pulse width (PW)  $\leq 1\text{ ms}$ , duty = 50 %

Note 2: Pulse width (PW)  $\leq 1\text{ }\mu\text{s}$ , 300 pps

Note 3: This device is considered as a two-terminal device: Pins 1 and 3 are shorted together, and pins 4, 5 and 6 are shorted together.

## 8. Recommended Operating Conditions (Note)

Characteristics	Symbol	Note	Min	Typ.	Max	Unit
Input on-state current	$I_{F(ON)}$	(Note 1)	7.5	—	14	mA
Input off-state voltage	$V_{F(OFF)}$		0	—	0.8	V
Supply voltage	$V_{CC}$	(Note 2)	2.7	3.3/5.0	5.5	
Operating temperature	$T_{opr}$	(Note 2)	-40	—	125	°C

Note: The recommended operating conditions are given as a design guide necessary to obtain the intended performance of the device. Each parameter is an independent value. When creating a system design using this device, the electrical characteristics specified in this data sheet should also be considered.

Note: A ceramic capacitor (0.1  $\mu\text{F}$ ) should be connected between pin 4 and pin 6 to stabilize the operation of a high-gain linear amplifier. Otherwise, this photocoupler may not switch properly. The bypass capacitor should be placed within 1 cm of each pin.

Note 1: The rise and fall times of the input on-current should be less than 0.5  $\mu\text{s}$ .

Note 2: Denotes the operating range, not the recommended operating condition.

## 9. Electrical Characteristics (Note) (Unless otherwise specified, $T_a = -40$ to $125$ °C, $V_{CC} = 2.7$ to $5.5$ V)

Characteristics	Symbol	Note	Test Circuit	Test Condition	Min	Typ.	Max	Unit
Input forward voltage	$V_F$		—	$I_F = 10$ mA, $T_a = 25$ °C	1.45	1.55	1.7	V
Input forward voltage temperature coefficient	$\Delta V_F / \Delta T_a$		—	$I_F = 10$ mA	—	-2.0	—	mV/°C
Input reverse current	$I_R$		—	$V_R = 5$ V, $T_a = 25$ °C	—	—	10	μA
Input capacitance	$C_t$		—	$V = 0$ V, $f = 1$ MHz, $T_a = 25$ °C	—	60	—	pF
High-level output current	$I_{OH}$		Fig. 12.1.1	$V_F = 0.8$ V, $V_O = 5.5$ V, $V_{CC} = 5.5$ V	—	—	50	μA
				$V_F = 0.8$ V, $V_O = 5.5$ V, $V_{CC} = 5.5$ V, $T_a = 25$ °C	—	—	10	
Low-level output voltage	$V_{OL}$		Fig. 12.1.2	$I_F = 10$ mA $I_O = 13$ mA (Sinking)	—	0.2	0.6	V
High-level supply current	$I_{CCH}$		Fig. 12.1.3	$I_F = 0$ mA	—	1.6	4.0	mA
Low-level supply current	$I_{CCL}$		Fig. 12.1.4	$I_F = 10$ mA	—	2.0	4.0	
Threshold input current (H/L)	$I_{FHL}$		—	$I_O = 13$ mA (Sinking), $V_O < 0.6$ V	—	1.0	5.0	

Note: All typical values are at  $V_{CC} = 5$  V,  $T_a = 25$  °C.

## 10. Isolation Characteristics (Unless otherwise specified, $T_a = 25$ °C)

Characteristics	Symbol	Note	Test Conditions	Min	Typ.	Max	Unit
Total capacitance (input to output)	$C_S$	(Note 1)	$V_S = 0$ V, $f = 1$ MHz	—	0.8	—	pF
Isolation resistance	$R_S$	(Note 1)	$V_S = 500$ V, R.H. ≤ 60 %	$10^{12}$	$10^{14}$	—	Ω
Isolation voltage	$BV_S$	(Note 1)	AC, 60 s	3750	—	—	Vrms

Note 1: This device is considered as a two-terminal device: Pins 1 and 3 are shorted together, and pins 4, 5 and 6 are shorted together.

## 11. Switching Characteristics (Note) (Unless otherwise specified, $T_a = -40$ to $125$ °C, $V_{CC} = 2.7$ to $5.5$ V)

Characteristics	Symbol	Note	Test Circuit	Test Condition	Min	Typ.	Max	Unit
Propagation delay time (H/L)	$t_{pHL}$	(Note 1)	Fig. 12.1.5	$I_F = 0 \rightarrow 7.5$ mA, $R_L = 350$ $\Omega$ , $C_L = 15$ pF	—	35	100	ns
Propagation delay time (L/H)	$t_{pLH}$	(Note 1)		$I_F = 7.5 \rightarrow 0$ mA, $R_L = 350$ $\Omega$ , $C_L = 15$ pF	—	26	100	
Pulse width distortion	$ t_{pHL} - t_{pLH} $	(Note 1)		$I_F = 7.5$ mA, $R_L = 350$ $\Omega$ , $C_L = 15$ pF	—	9	35	
Propagation delay skew (device to device)	$t_{psk}$	(Note 1), (Note 2)		$I_F = 7.5$ mA, $R_L = 350$ $\Omega$ , $C_L = 15$ pF	-40	—	40	
Fall time	$t_f$	(Note 1)		$I_F = 0 \rightarrow 7.5$ mA, $R_L = 350$ $\Omega$ , $C_L = 15$ pF	—	2.6	—	
Rise time	$t_r$	(Note 1)		$I_F = 7.5 \rightarrow 0$ mA, $R_L = 350$ $\Omega$ , $C_L = 15$ pF	—	12.8	—	
High-level common-mode transient immunity	$CM_H$		Fig. 12.1.6	$V_{CM} = 1000$ V <sub>p-p</sub> , $I_F = 0$ mA, $V_{CC} = 3.3$ V / 5 V, $T_a = 25$ °C	$\pm 20$	$\pm 25$	—	kV/ $\mu$ s
Low-level common-mode transient immunity	$CM_L$			$V_{CM} = 1000$ V <sub>p-p</sub> , $I_F = 10$ mA, $V_{CC} = 3.3$ V / 5 V, $T_a = 25$ °C	$\pm 20$	$\pm 25$	—	

Note: All typical values are at  $V_{CC} = 5$  V,  $T_a = 25$  °C.

Note 1:  $f = 5$  MHz, duty = 50 %, input current  $t_r = t_f = 5$  ns or less,  $C_L$  is less than 15 pF which includes probe and stray wiring capacitance.

Note 2: The propagation delay skew,  $t_{psk}$ , is equal to the magnitude of the worst-case difference in  $t_{pHL}$  and/or  $t_{pLH}$  that will be seen between units at the same given conditions (supply voltage, input current, temperature, etc.).

## 12. Test Circuits and Characteristics Curves

### 12.1. Test Circuits

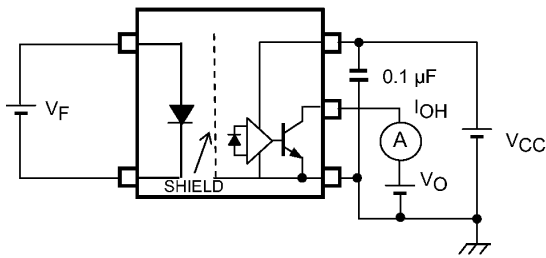

Fig. 12.1.1 IOH Test Circuit

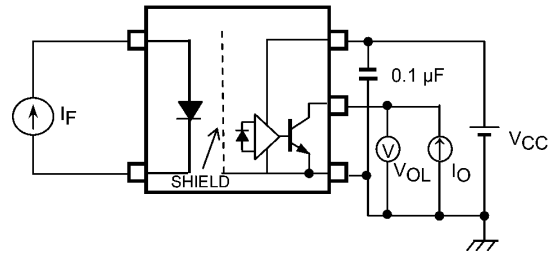

Fig. 12.1.2 VOL Test Circuit

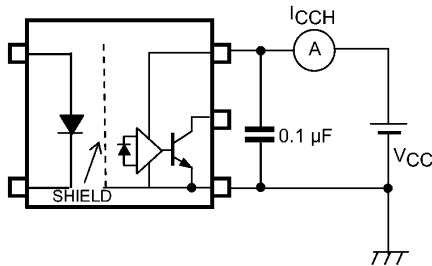

Fig. 12.1.3 ICCH Test Circuit

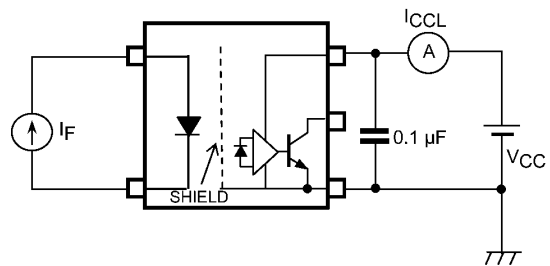
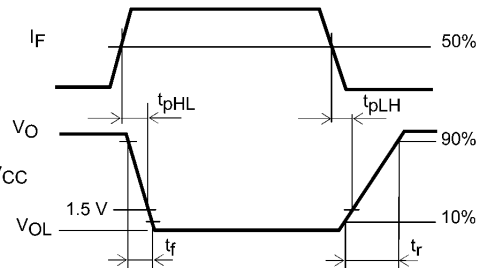
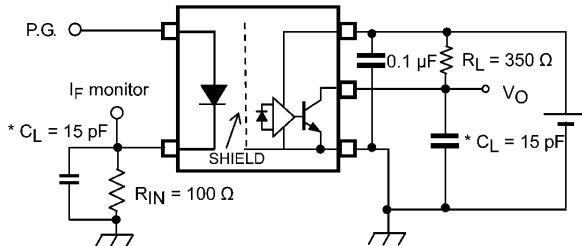

Fig. 12.1.4 ICCL Test Circuit

$I_F = 7.5 \text{ mA (P.G.)}$   
 $(f = 5 \text{ MHz, duty} = 50\%, t_r = t_f = \text{less than } 5 \text{ ns})$



\*CL includes probe and stray capacitance.  
 P.G.: Pulse generator

Fig. 12.1.5 Switching Time Test Circuit and Waveform

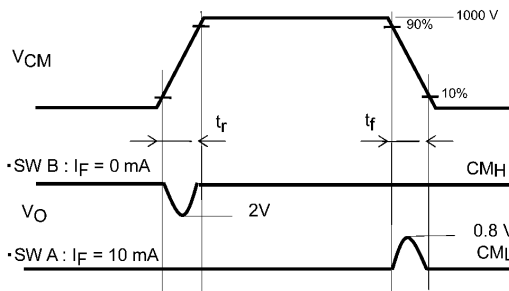
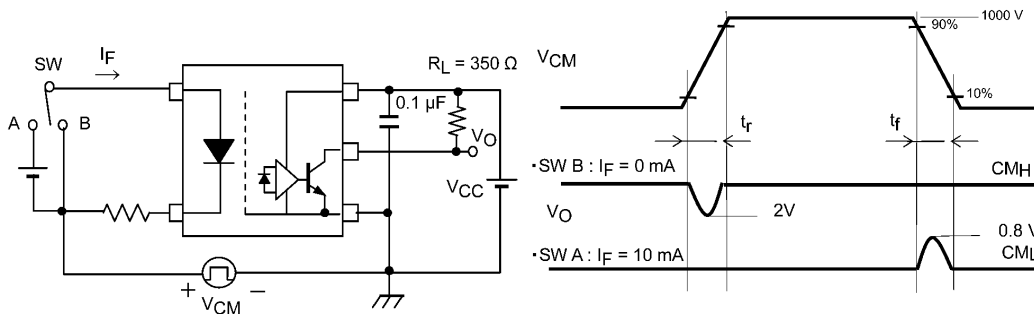

$$CM_H = \frac{800(V)}{t_r (\mu s)} \quad CM_L = - \frac{800(V)}{t_f (\mu s)}$$

Fig. 12.1.6 Common-Mode Transient Immunity Test Circuit and Waveform

## 12.2. Characteristics Curves (Note)

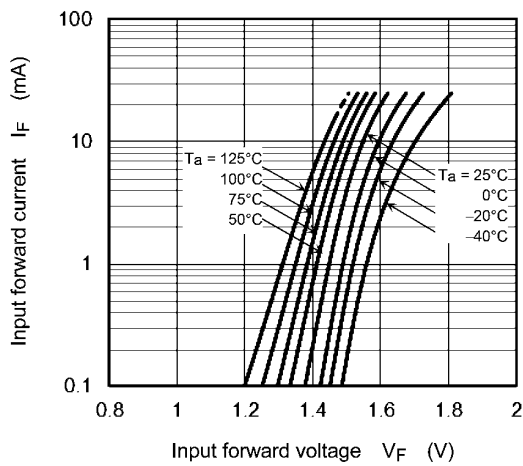

Fig. 12.2.1  $I_F - V_F$

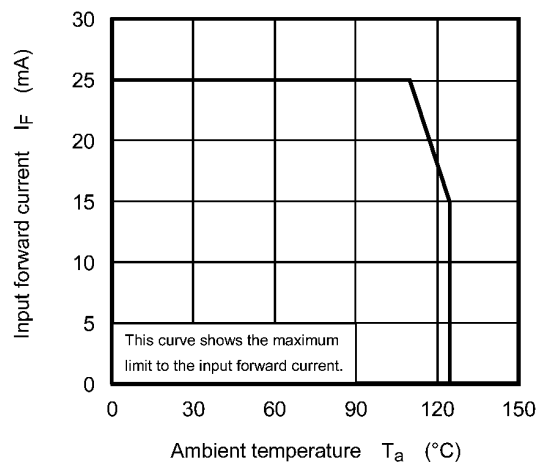

Fig. 12.2.2  $I_F - T_a$

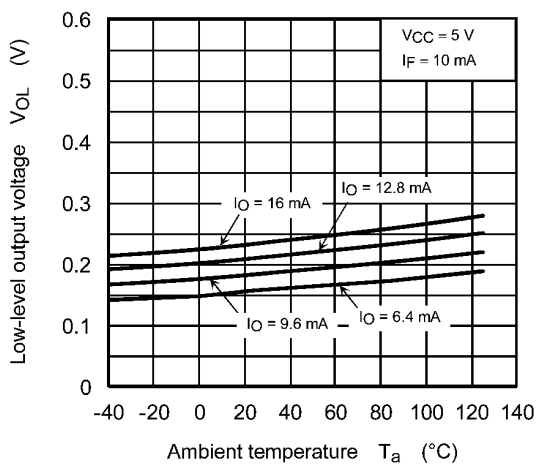

Fig. 12.2.3  $V_{OL} - T_a$

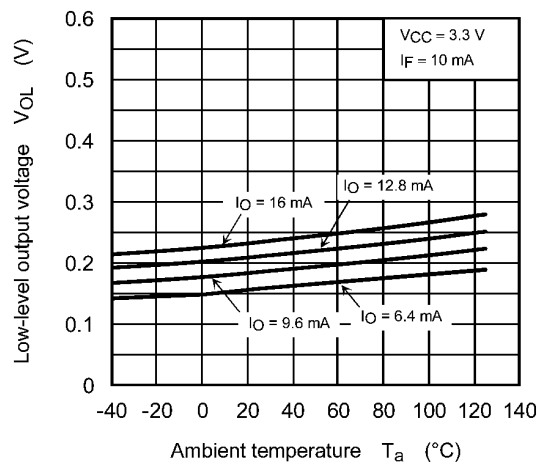

Fig. 12.2.4  $V_{OL} - T_a$

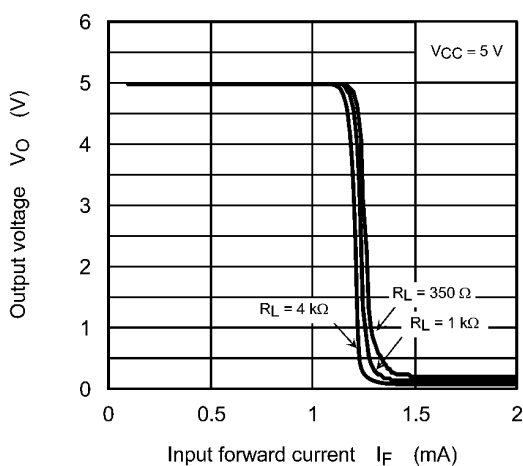

Fig. 12.2.5  $V_O - I_F$

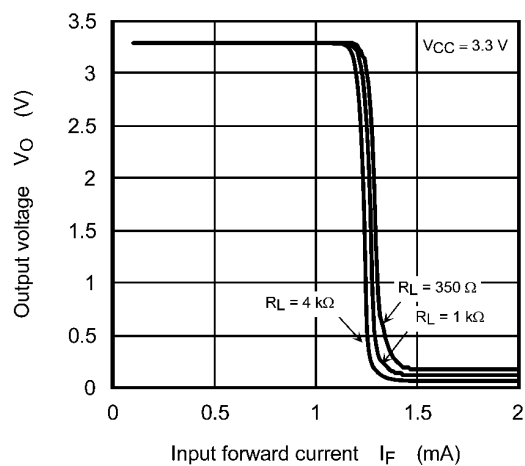

Fig. 12.2.6  $V_O - I_F$

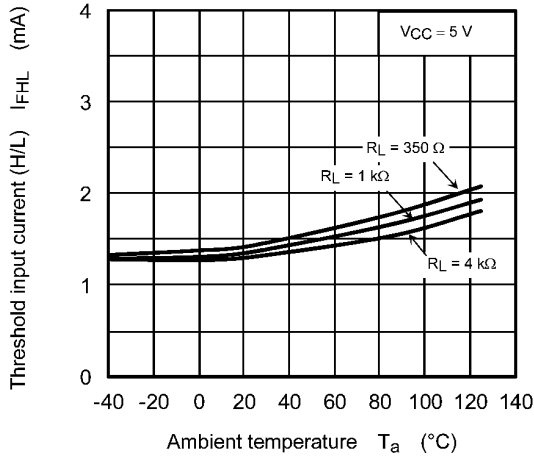

Fig. 12.2.7  $I_{FHL} - T_a$

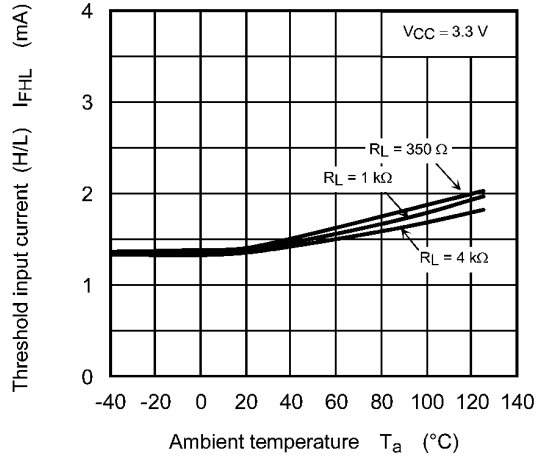

Fig. 12.2.8  $I_{FHL} - T_a$

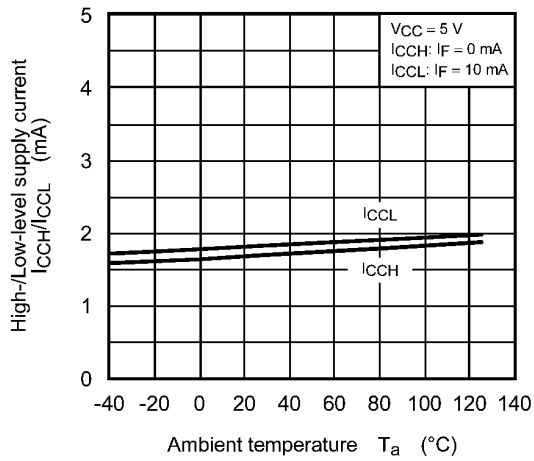

Fig. 12.2.9  $I_{CCH}, I_{CCL} - T_a$

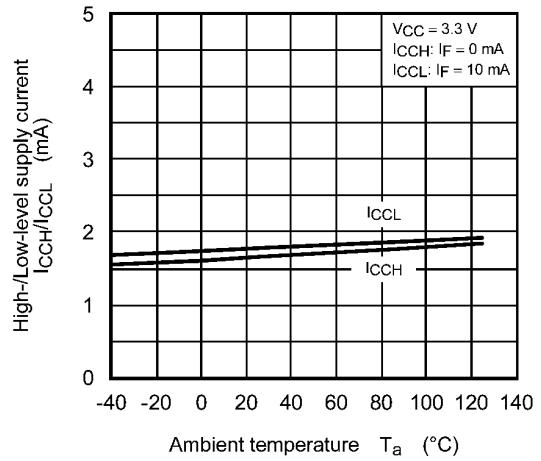

Fig. 12.2.10  $I_{CCH}, I_{CCL} - T_a$

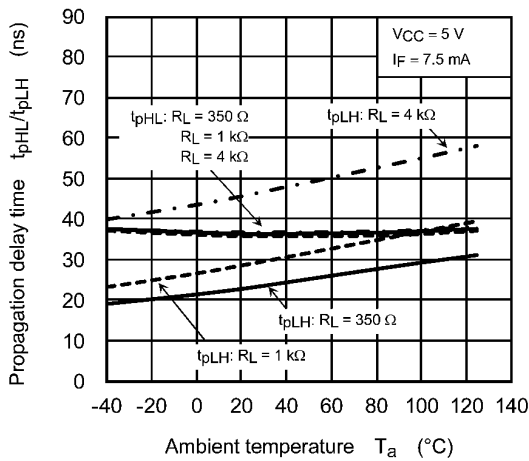

Fig. 12.2.11  $t_{pHL}, t_{pLH} - T_a$

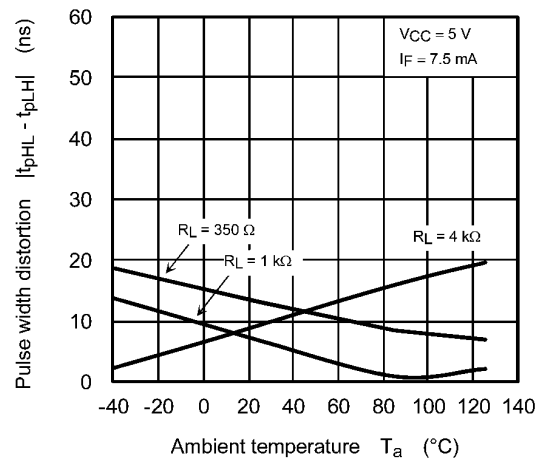
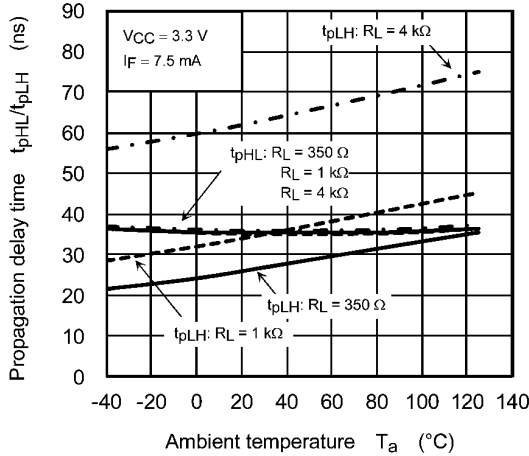
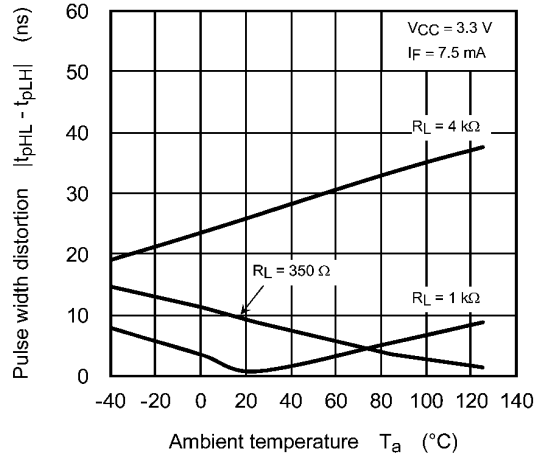

Fig. 12.2.12  $|t_{pHL} - t_{pLH}| - T_a$

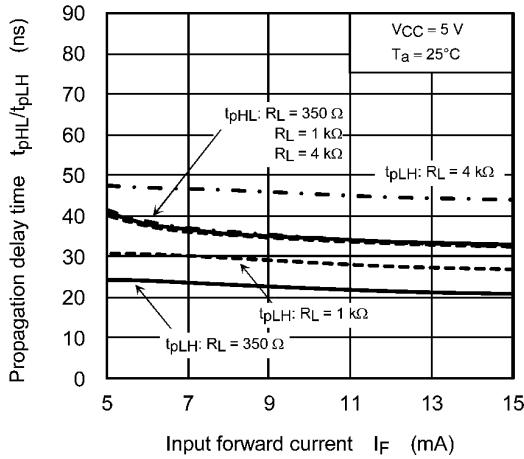



**Fig. 12.2.13**  $t_{pHL}, t_{pLH} - T_a$



**Fig. 12.2.14**  $|t_{pHL} - t_{pLH}| - T_a$



**Fig. 12.2.15**  $t_{pHL}, t_{pLH} - I_F$

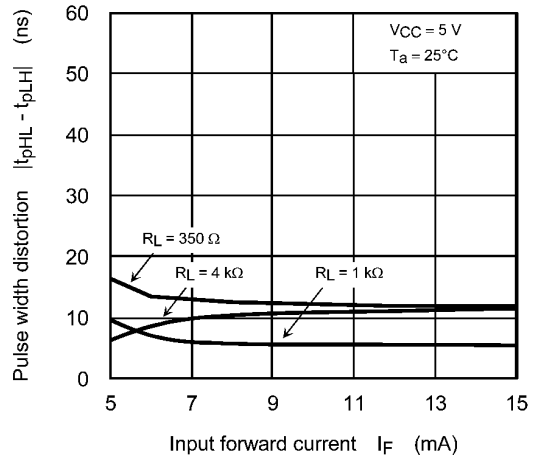

**Fig. 12.2.16**  $|t_{pHL} - t_{pLH}| - I_F$

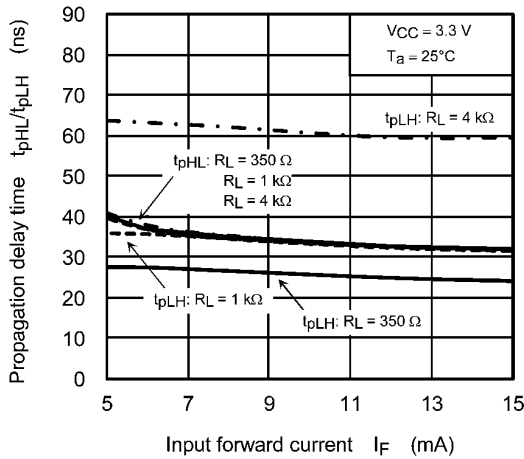

**Fig. 12.2.17**  $t_{pHL}, t_{pLH} - I_F$

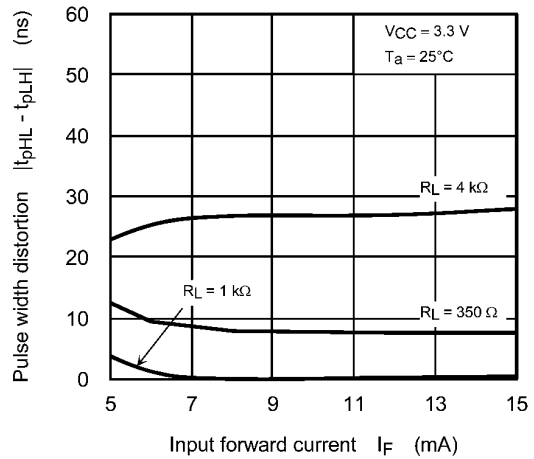

**Fig. 12.2.18**  $|t_{pHL} - t_{pLH}| - I_F$

Note: The above characteristics curves are presented for reference only and not guaranteed by production test, unless otherwise noted.

## 13. Soldering and Storage

### 13.1. Precautions for Soldering

The soldering temperature should be controlled as closely as possible to the conditions shown below, irrespective of whether a soldering iron or a reflow soldering method is used.

- When using soldering reflow.

The soldering temperature profile is based on the package surface temperature.

(See the figure shown below, which is based on the package surface temperature.)

Reflow soldering must be performed once or twice.

The mounting should be completed with the interval from the first to the last mountings being 2 weeks.

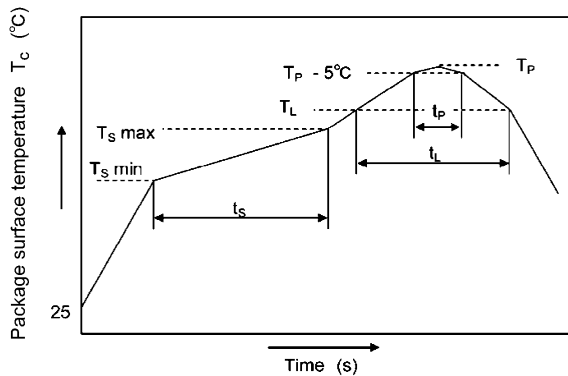

	Symbol	Min	Max	Unit
Preheat temperature	$T_S$	150	200	°C
Preheat time	$t_s$	60	120	s
Ramp-up rate ( $T_L$ to $T_P$ )			3	°C/s
Liquidus temperature	$T_L$	217		°C
Time above $T_L$	$t_L$	60	150	s
Peak temperature	$T_P$		260	°C
Time during which $T_c$ is between ( $T_P - 5$ ) and $T_P$	$t_p$		30	s
Ramp-down rate ( $T_P$ to $T_L$ )			6	°C/s

**An Example of a Temperature Profile When Lead(Pb)-Free Solder Is Used**

- When using soldering flow  
Preheat the device at a temperature of 150 °C (package surface temperature) for 60 to 120 seconds.  
Mounting condition of 260 °C within 10 seconds is recommended.  
Flow soldering must be performed once.
- When using soldering Iron  
Complete soldering within 10 seconds for lead temperature not exceeding 260 °C or within 3 seconds not exceeding 350 °C  
Heating by soldering iron must be done only once per lead.

### 13.2. Precautions for General Storage

- Avoid storage locations where devices may be exposed to moisture or direct sunlight.
- Follow the precautions printed on the packing label of the device for transportation and storage.
- Keep the storage location temperature and humidity within a range of 5 °C to 35 °C and 45 % to 75 %, respectively.
- Do not store the products in locations with poisonous gases (especially corrosive gases) or in dusty conditions.
- Store the products in locations with minimal temperature fluctuations. Rapid temperature changes during storage can cause condensation, resulting in lead oxidation or corrosion, which will deteriorate the solderability of the leads.
- When restoring devices after removal from their packing, use anti-static containers.
- Do not allow loads to be applied directly to devices while they are in storage.
- If devices have been stored for more than two years under normal storage conditions, it is recommended that you check the leads for ease of soldering prior to use.

**14. Land Pattern Dimensions (for reference only)**

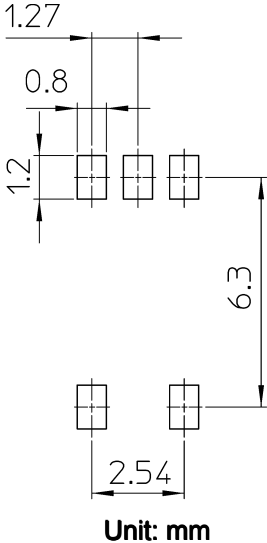

**15. Marking**

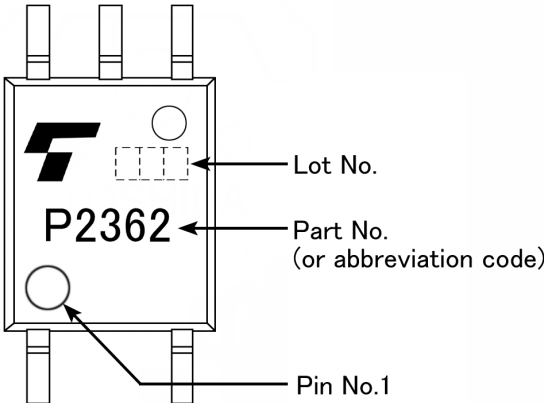

## 16. EN 60747-5-5 Option (V4) Specification

- Part number: TLP2362 (**Note 1**)
- The following part naming conventions are used for the devices that have been qualified according to option (V4) of EN 60747.

Example: TLP2362(V4-TPL,E)

V4: EN 60747 option

TPL: Tape type

E: [[G]]/RoHS COMPATIBLE (**Note 2**)

Note 1: Use TOSHIBA standard type number for safety standard application.

e.g., TLP2362(V4-TPL,E → TLP2362

Note 2: Please contact your Toshiba sales representative for details on environmental information such as the product's RoHS compatibility.

RoHS is the Directive 2011/65/EU of the European Parliament and of the Council of 8 June 2011 on the restriction of the use of certain hazardous substances in electrical and electronic equipment.

Description	Symbol	Rating	Unit
Application classification for rated mains voltage $\leq 150$ Vrms for rated mains voltage $\leq 300$ Vrms		I-IV I-III	—
Climatic classification		40 / 125 / 21	—
Pollution degree		2	—
Maximum operating insulation voltage	$V_{IORM}$	707	Vpeak
Input to output test voltage, Method A $V_{pr} = 1.6 \times V_{IORM}$ , type and sample test $t_p = 10$ s, partial discharge $< 5$ pC	$V_{pr}$	1131	Vpeak
Input to output test voltage, Method B $V_{pr} = 1.875 \times V_{IORM}$ , 100 % production test $t_p = 1$ s, partial discharge $< 5$ pC	$V_{pr}$	1325	Vpeak
Highest permissible overvoltage (transient overvoltage, $t_{pr} = 60$ s)	$V_{TR}$	6000	Vpeak
Safety limiting values (max. permissible ratings in case of fault, also refer to thermal derating curve) current (input current $I_F$ , $P_{SO} = 0$ ) power (output or total power dissipation) temperature	$I_{si}$ $P_{SO}$ $T_s$	250 400 150	mA mW °C
Insulation resistance $V_{IO} = 500$ V, $T_a = 25$ °C $V_{IO} = 500$ V, $T_a = 100$ °C $V_{IO} = 500$ V, $T_a = T_s$	$R_{si}$	$\geq 10^{12}$ $\geq 10^{11}$ $\geq 10^9$	$\Omega$

Fig. 16.1 EN 60747 Isolation Characteristics

Minimum creepage distance	Cr	5.0 mm
Minimum clearance	Cl	5.0 mm
Minimum insulation thickness	ti	0.4 mm
Comparative tracking index	CTI	175

**Fig. 16.2 Insulation Related Specifications (Note)**

Note: This photocoupler is suitable for **safe electrical isolation** only within the safety limit data. Maintenance of the safety data shall be ensured by means of protective circuits.



**Fig. 16.3 Marking on Packing**

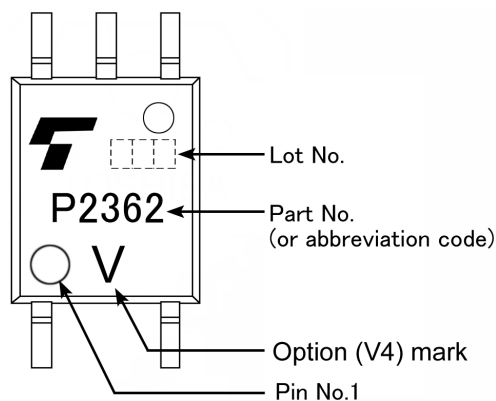

**Fig. 16.4 Marking Example (Note)**

Note: The above marking is applied to the photocouplers that have been qualified according to option (V4) of EN 60747.

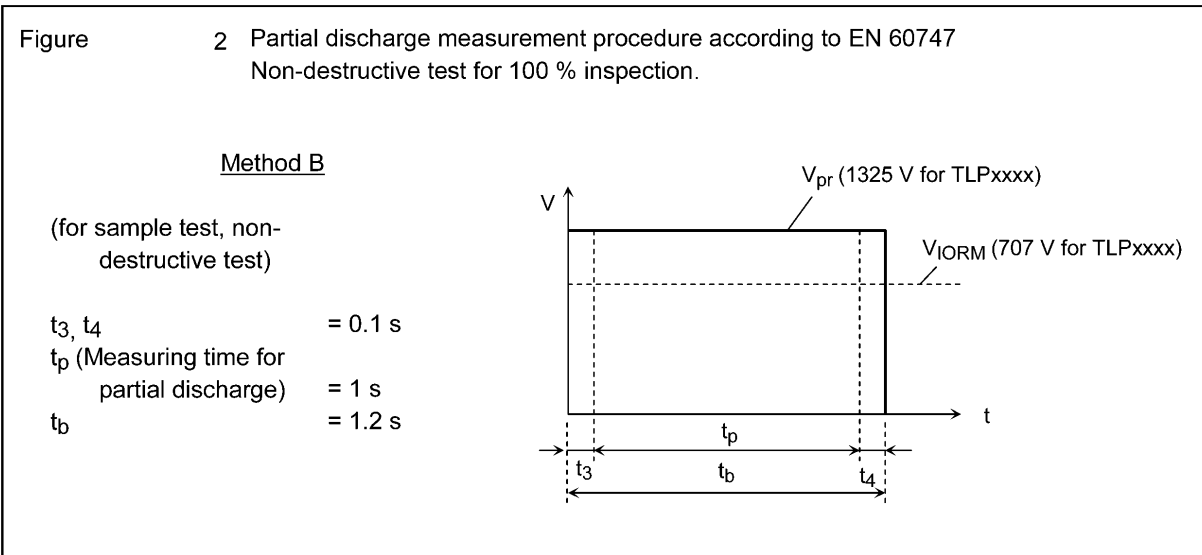
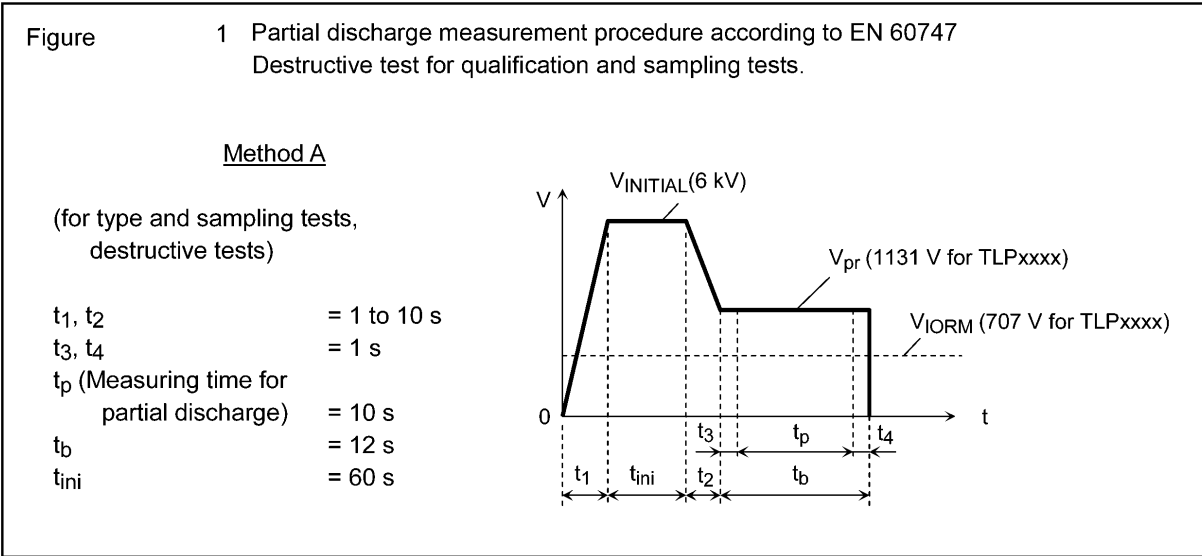

Fig. 16.5 Measurement Procedure

## 17. Ordering Information

When placing an order, please specify the part number, tape type and quantity as shown in the following example.

Example) TLP2362(TPL,E 3000 pcs

Part number: TLP2362

Tape type: TPL (12-mm pitch)

[[G]]/RoHS COMPATIBLE: E (**Note 1**)

Quantity (must be a multiple of 3000): 3000 pcs

Note 1: Please contact your Toshiba sales representative for details on environmental information such as the product's RoHS compatibility.

RoHS is the Directive 2011/65/EU of the European Parliament and of the Council of 8 June 2011 on the restriction of the use of certain hazardous substances in electrical and electronic equipment.

## Package Dimensions

Unit: mm

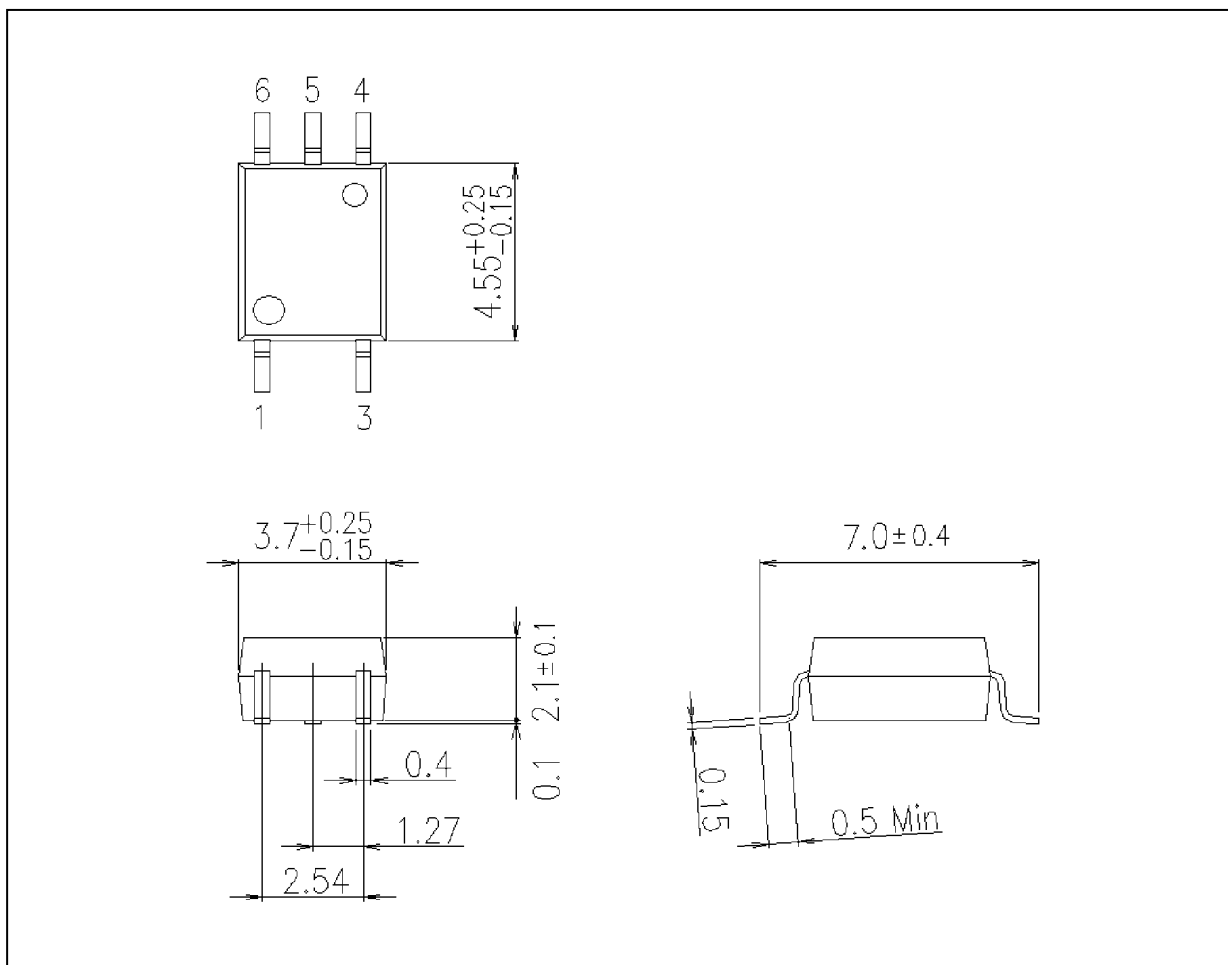

Weight: 0.08 g (typ.)

Package Name(s)
TOSHIBA: 11-4L1S



## RESTRICTIONS ON PRODUCT USE

Toshiba Corporation and its subsidiaries and affiliates are collectively referred to as "TOSHIBA".

Hardware, software and systems described in this document are collectively referred to as "Product".

- TOSHIBA reserves the right to make changes to the information in this document and related Product without notice.
- This document and any information herein may not be reproduced without prior written permission from TOSHIBA. Even with TOSHIBA's written permission, reproduction is permissible only if reproduction is without alteration/omission.
- Though TOSHIBA works continually to improve Product's quality and reliability, Product can malfunction or fail. Customers are responsible for complying with safety standards and for providing adequate designs and safeguards for their hardware, software and systems which minimize risk and avoid situations in which a malfunction or failure of Product could cause loss of human life, bodily injury or damage to property, including data loss or corruption. Before customers use the Product, create designs including the Product, or incorporate the Product into their own applications, customers must also refer to and comply with (a) the latest versions of all relevant TOSHIBA information, including without limitation, this document, the specifications, the data sheets and application notes for Product and the precautions and conditions set forth in the "TOSHIBA Semiconductor Reliability Handbook" and (b) the instructions for the application with which the Product will be used with or for. Customers are solely responsible for all aspects of their own product design or applications, including but not limited to (a) determining the appropriateness of the use of this Product in such design or applications; (b) evaluating and determining the applicability of any information contained in this document, or in charts, diagrams, programs, algorithms, sample application circuits, or any other referenced documents; and (c) validating all operating parameters for such designs and applications.  
**TOSHIBA ASSUMES NO LIABILITY FOR CUSTOMERS' PRODUCT DESIGN OR APPLICATIONS.**

- **PRODUCT IS NEITHER INTENDED NOR WARRANTED FOR USE IN EQUIPMENTS OR SYSTEMS THAT REQUIRE EXTRAORDINARILY HIGH LEVELS OF QUALITY AND/OR RELIABILITY, AND/OR A MALFUNCTION OR FAILURE OF WHICH MAY CAUSE LOSS OF HUMAN LIFE, BODILY INJURY, SERIOUS PROPERTY DAMAGE AND/OR SERIOUS PUBLIC IMPACT ("UNINTENDED USE").**

Except for specific applications as expressly stated in this document, Unintended Use includes, without limitation, equipment used in nuclear facilities, equipment used in the aerospace industry, lifesaving and/or life supporting medical equipment, equipment used for automobiles, trains, ships and other transportation, traffic signaling equipment, equipment used to control combustions or explosions, safety devices, elevators and escalators, and devices related to power plant.

**IF YOU USE PRODUCT FOR UNINTENDED USE, TOSHIBA ASSUMES NO LIABILITY FOR PRODUCT.**

For details, please contact your TOSHIBA sales representative or contact us via our website.

- Do not disassemble, analyze, reverse-engineer, alter, modify, translate or copy Product, whether in whole or in part.
- Product shall not be used for or incorporated into any products or systems whose manufacture, use, or sale is prohibited under any applicable laws or regulations.
- The information contained herein is presented only as guidance for Product use. No responsibility is assumed by TOSHIBA for any infringement of patents or any other intellectual property rights of third parties that may result from the use of Product. No license to any intellectual property right is granted by this document, whether express or implied, by estoppel or otherwise.
- **ABSENT A WRITTEN SIGNED AGREEMENT, EXCEPT AS PROVIDED IN THE RELEVANT TERMS AND CONDITIONS OF SALE FOR PRODUCT, AND TO THE MAXIMUM EXTENT ALLOWABLE BY LAW, TOSHIBA (1) ASSUMES NO LIABILITY WHATSOEVER, INCLUDING WITHOUT LIMITATION, INDIRECT, CONSEQUENTIAL, SPECIAL, OR INCIDENTAL DAMAGES OR LOSS, INCLUDING WITHOUT LIMITATION, LOSS OF PROFITS, LOSS OF OPPORTUNITIES, BUSINESS INTERRUPTION AND LOSS OF DATA, AND (2) DISCLAIMS ANY AND ALL EXPRESS OR IMPLIED WARRANTIES AND CONDITIONS RELATED TO SALE, USE OF PRODUCT, OR INFORMATION, INCLUDING WARRANTIES OR CONDITIONS OF MERCHANTABILITY, FITNESS FOR A PARTICULAR PURPOSE, ACCURACY OF INFORMATION, OR NONINFRINGEMENT.**
- GaAs (Gallium Arsenide) is used in Product. GaAs is harmful to humans if consumed or absorbed, whether in the form of dust or vapor. Handle with care and do not break, cut, crush, grind, dissolve chemically or otherwise expose GaAs in Product.
- Do not use or otherwise make available Product or related software or technology for any military purposes, including without limitation, for the design, development, use, stockpiling or manufacturing of nuclear, chemical, or biological weapons or missile technology products (mass destruction weapons). Product and related software and technology may be controlled under the applicable export laws and regulations including, without limitation, the Japanese Foreign Exchange and Foreign Trade Law and the U.S. Export Administration Regulations. Export and re-export of Product or related software or technology are strictly prohibited except in compliance with all applicable export laws and regulations.
- Please contact your TOSHIBA sales representative for details as to environmental matters such as the RoHS compatibility of Product. Please use Product in compliance with all applicable laws and regulations that regulate the inclusion or use of controlled substances, including without limitation, the EU RoHS Directive. **TOSHIBA ASSUMES NO LIABILITY FOR DAMAGES OR LOSSES OCCURRING AS A RESULT OF NONCOMPLIANCE WITH APPLICABLE LAWS AND REGULATIONS.**

## X-ON Electronics

Largest Supplier of Electrical and Electronic Components

*Click to view similar products for [High Speed Optocouplers](#) category:*

*Click to view products by [Toshiba](#) manufacturer:*

Other Similar products are found below :

[PS8502L2-AX](#) [ACNW261L-000E](#) [ACPL-344JT-000E](#) [ACPL-K49T-500E](#) [ACPL-K74T-000E](#) [ACPL-K75T-000E](#) [ACPL-W21L-560E](#) [ACPL-K44T-500E](#) [TLP187\(TPL,E\(T](#) [TLP2601\(TP1,F\)](#) [610737H](#) [6N137A-X001](#) [6N137A-X017T](#) [6N139-X007T](#) [HCPL2630M](#) [HCPL2731SM](#) [TLP555\(F\)](#) [HCPL2630SM](#) [PS2841-4A-F3-AX](#) [PS9817A-1-F3-AX](#) [PS9821-2-F3-AX](#) [ORPC-817D](#) [ORPC-817M/C](#) [ORPC-817M/B](#) [PT17-51C/L129\(BIN2\)](#) [TLP521-4GBSM](#) [UMW817C](#) [6N137S1\(TA\)](#) [TLP521GB](#) [TLP521GB-S](#) [PS2501](#) [PS2501-S](#) [TLP785GB](#) [TLP785GB-S](#) [LTV-214-G](#) [TLP2766A\(E](#) [TLP2766A\(LF4,E](#) [LCR-0202](#) [EL814S1\(TA\)-V](#) [PC817X4NSZ2B](#) [CYPC817](#) [OR-MOC3023](#) [TLP267J\(TPL,E\(T](#) [TLP109\(TPL,E\(O](#) [EL2514S1\(TU\)\(CLW\)-G](#) [EL816S2\(C\)\(TU\)-F](#) [TLP281-4](#) [MOC3023M](#) [ACPL-K49T-060E](#) [ACPL-K75T-500E](#)