

Toshiba Intelligent Power Device Silicon Monolithic Power MOS Integrated Circuit

TPD1052F

High-side Power Switch for Motor, Solenoid and Lamp Drivers

The TPD1052F is a monolithic power IC intended for high-side load switching applications. The input can be directly driven from CMOS or TTL logic (e.g., an MPU). The TPD1052F provides intelligent protection and diagnostic functions.

Features

- A structure that incorporates Bi-CMOS control circuitry and a power MOSFET (DMOS) on a single chip.
- One side of the load can be grounded.
- Can be directly driven from a microprocessor.
- Overtemperature and load short-circuit (Overcurrent) protections are built in.
- Incorporates a diagnosis function that allows diagnosis output to be read externally at load short (Overcurrent), overtemperature.
- Low ON- resistance. : $R_{DS(ON)} = 0.8\Omega$ (Max) @ $V_{DD} = 12V$, $I_O = 0.5A$, $T_{ch}=25^\circ C$
- Low supply current. : $I_{DD} = 10\mu A$ (Max), @ $V_{DD} = 12V$, $V_{IN} = 0V$, $T_{ch}=25^\circ C$
- Housed in the PS-8 package and supplied in embossed carrier tape.

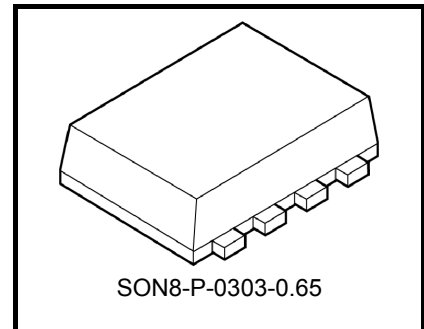

Weight: 0.017g (typ.)

Pin Assignment (top view)

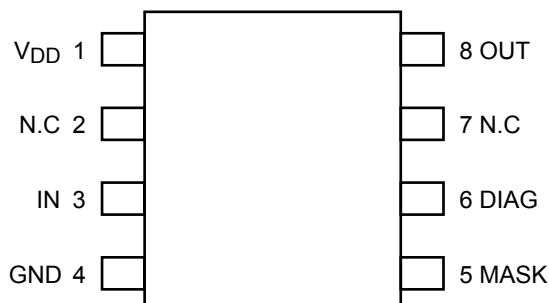

Marking

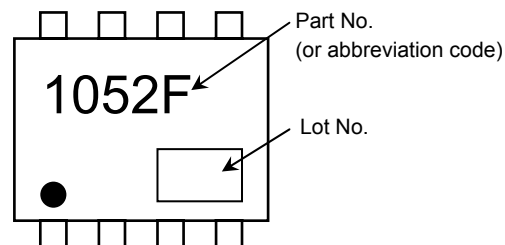

•Note: ● on the lower left of the marking indicates Pin 1

※Weekly code: (Three digits)

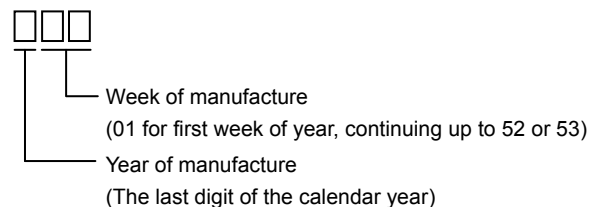

Please contact your TOSHIBA sales representative for details as to environmental matters such as the RoHS compatibility of Product.

The RoHS is the Directive 2011/65/EU of the European Parliament and of the Council of 8 June 2011 on the restriction of the use of certain

Note: That because of its MOS structure, this product is sensitive to static electricity.

Start of commercial production
2009-03

Block Diagram

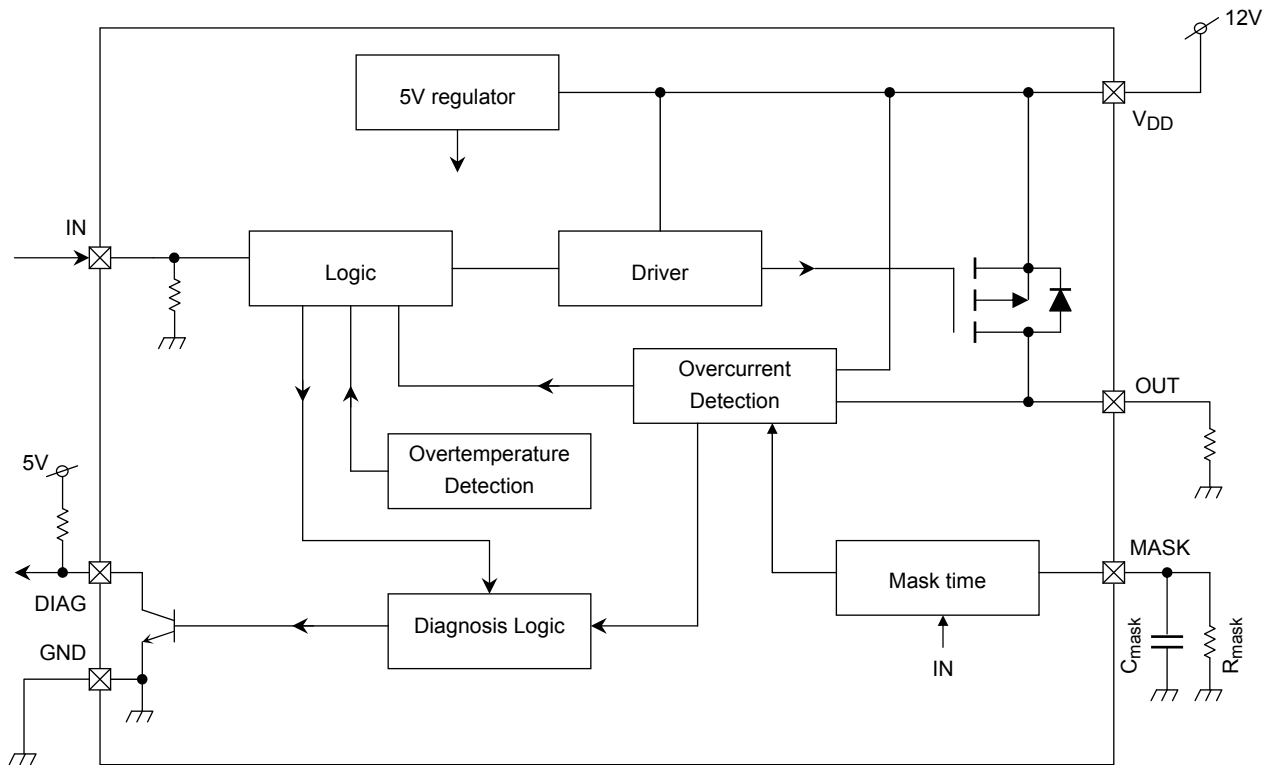

Pin Description

Pin No.	Symbol	Function
1	VDD	Power supply pin.
2, 7	N.C	No-Connect pin.
3	IN	Input pin. The IN pin has an internal pull-down resistor. Even if the IN pin is open, the output will not accidentally turn on.
4	GND	Ground pin.
5	MASK	Overcurrent detection/protection is IOC(clamp) in the Mask time. If the capacitor and the resistance is not connected to MASK pin, overcurrent protection is IOC(duty).
6	DIAG	Self-diagnosis detection pin. npn open collector. When Input is "H"(Output on), and Overcurrent or Overtemperature is detected, DIAG becomes low level and it is latched. When input is low level, the state of latch is reseted.
8	OUT	Output pin. When a load short-circuit causes an overcurrent (0.8A Min) to flow into a device, output current is limited in order to protect the IC.

Timing Chart

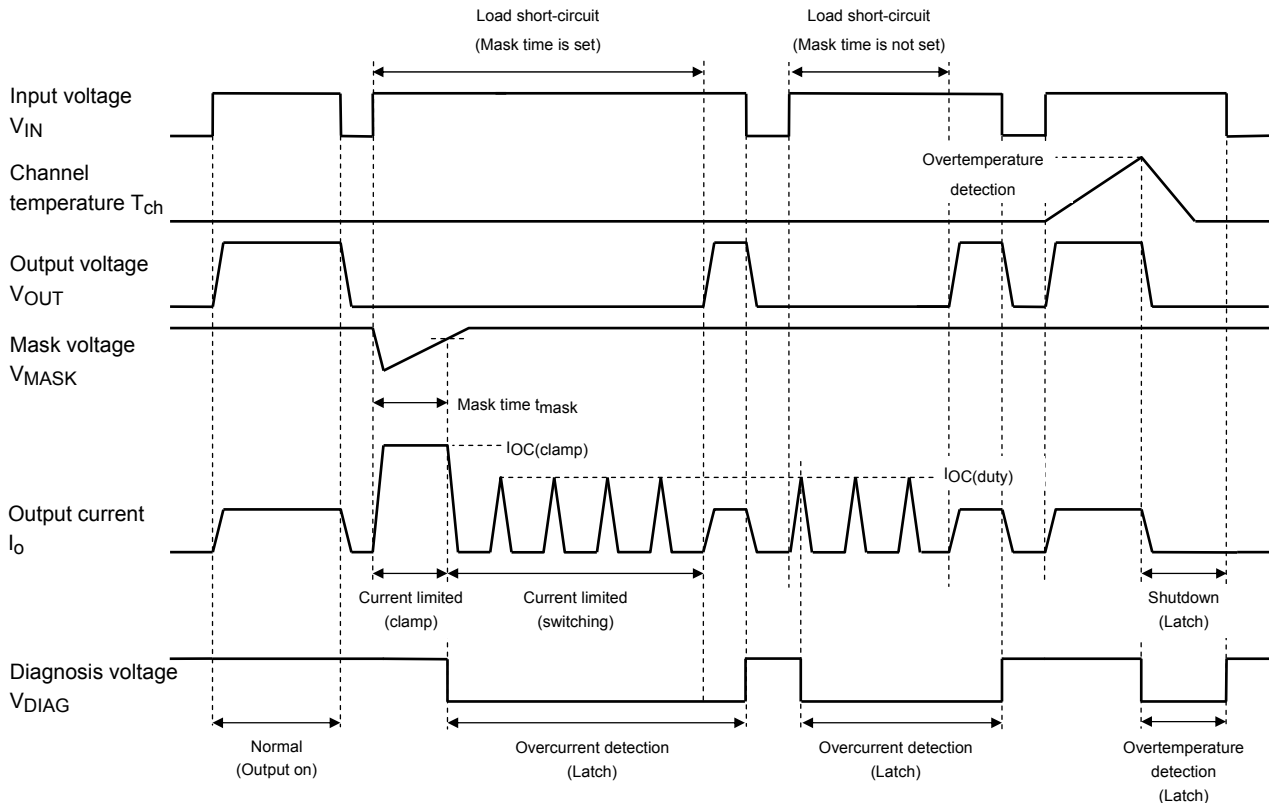

Truth Table

Input Signal		Output MOSFET State	Diagnosis Output	Operating State
H		On	H	Normal
L		Off	H	
H	$t \leq t_{mask}$ (Note)	Current limiting (clamp)	H	Overcurrent (Load short-circuit)
	$t > t_{mask}$ (Note)	Current limiting (switching)	L (Latch)	
L		Off	H	
H		Off (Latch)	L (Latch)	Overtemperature
L		Off	H	

※Note : t is time from the $V_{IN}=H$ input.

Absolute Maximum Ratings (T_a = 25°C)

Characteristics	Symbol	Rating	Unit
Drain-source voltage	V _{DS}	40	V
Supply voltage	DC	V _{DD} (1)	-0.3 to 25
	Pulse	V _{DD} (2)	40 (t ≤ 200ms)
Input voltage	V _{IN}	-0.3 to 6	V
Diagnosis output voltage	V _{DIAG}	-0.3 to 6	V
Output current	I _O	Internally limited	A
Diagnosis output current	I _{DIAG}	5	mA
Power dissipation (Note 1a)	P _D (1)	0.7	W
Power dissipation (Note 1b)	P _D (2)	0.35	W
Operating temperature	T _{opr}	-40 to 125	°C
Channel temperature	T _{ch}	150	°C
Storage temperature	T _{stg}	-55 to 150	°C

Note: Using continuously under heavy loads (e.g. the application of high temperature/current/voltage and the significant change in temperature, etc.) may cause this product to decrease in the reliability significantly even if the operating conditions (i.e. operating temperature/current/voltage, etc.) are within the absolute maximum ratings and the operating ranges.

Please design the appropriate reliability upon reviewing the Toshiba Semiconductor Reliability Handbook ("Handling Precautions"/"Derating Concept and Methods") and individual reliability data (i.e. reliability test report and estimated failure rate, etc).

Thermal Resistance

Characteristics	Symbol	Rating	Unit
Thermal resistance, channel to ambient	R _{th} (ch-a)	178.6(Note 1a)	°C / W
		357.2(Note 1b)	

Note 1:

(a) Glass epoxy board

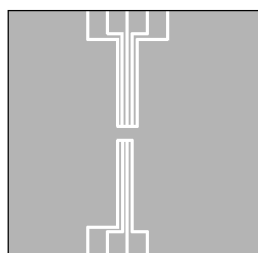

Glass epoxy board
Material : FR-4
25.4mm × 25.4mm × 0.8mm

(b) Glass epoxy board

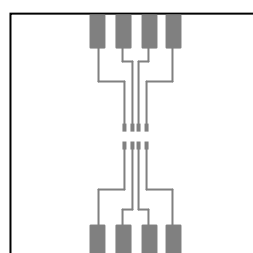

Glass epoxy board
Material : FR-4
25.4mm × 25.4mm × 0.8mm

Electrical Characteristics (Unless otherwise specified $T_{ch} = -40$ to 125°C , $V_{DD} = 5$ to 18V)

Characteristics		Symbol	Test Circuit	Test Condition	Min	Typ.	Max	Unit
Operating supply voltage		$V_{DD}(\text{opr})$	—	—	5	12	18	V
Supply current		I_{DD}	—	$V_{DD} = 12\text{V}$, $V_{IN} = 0\text{V}$, Output open.	—	—	10	μA
Output leakage current		I_{OL}	—	$V_{IN} = V_{OUT} = 0\text{V}$	—	—	10	μA
Input voltage		V_{IH}	—	$V_{DD} = 8$ to 18V	2.0	—	—	V
		V_{IL}	—	$V_{DD} = 8$ to 18V	—	—	0.8	V
Input current		$I_{IN}(1)$	—	$V_{IN} = 5\text{V}$	—	—	200	μA
		$I_{IN}(2)$	—	$V_{IN} = 0\text{V}$	-0.2	—	0.2	μA
Drain-source ON-resistance		$R_{DS(ON)}$	—	$V_{DD} = 8$ to 18V , $I_O = 0.5\text{A}$, $V_{IN} = 5\text{V}$, $T_{ch} = 25^{\circ}\text{C}$	—	0.5	0.8	Ω
Diagnosis output voltage	Low level	V_{DL}	—	$I_{DIAG} = 1\text{mA}$	—	—	0.4	V
Diagnosis output current	High level	I_{DH}	—	$V_{DIAG} = 5\text{V}$	—	—	10	μA
Overcurrent detection		$I_{OC(\text{clamp})}$	—	$V_{DD} = 8$ to 18V	1.2	1.7	2.3	A
		$I_{OC(\text{duty})}$	—		0.8	1.3	1.8	A
Overtemperature detection		T_{OT}	—	—	150	160	200	$^{\circ}\text{C}$
Mask time(Note 2)		t_{mask}	—	$C_{\text{mask}} = 0.033\ \mu\text{F}$, $R_{\text{mask}} = 1\text{M}\Omega$, $V_{DD} = 8$ to 18V , $T_{ch} = 25^{\circ}\text{C}$	—	3.8	—	ms
Switching times		t_{ON}	1	$V_{DD} = 12\text{V}$, $R_L = 24\ \Omega$, $T_{ch} = 25^{\circ}\text{C}$	1	10	30	μs
		t_{OFF}	1		1	20	60	μs

Note 2: About the Mask time function

Mask time function is built in TPD1052F. Mask time is decided to prevent discharge electricity by switching-mode overcurrent protection that occur by inrush current. To prevent discharge electricity by overcurrent protection (switching) that operate by inrush current, Mask time is used. Overcurrent protection is clamp current in Mask time from $V_{IN} = \text{H}$.

Mask time can roughly set at nether expression.

$$t_{\text{mask}} = -C_{\text{mask}} \times R_{\text{mask}} \times \ln \left(1 - \frac{R_{\text{ref}}}{R_{\text{mask}}} \right) \quad [\text{s}]$$

R_{ref} : Internal resistance 110k Ω (typ.)

- ※ When the Mask time is changed, please change C_{mask} in the state of $R_{\text{mask}} = 1\text{M}\Omega$.
- ※ When overcurrent protection (clamp) is operating, TPD1052F becomes high temperature. Therefore please set Mask time for channel temperature to become 150°C or less.
- ※ If you do not use Mask time, please open the MASK pin.

Test Circuit 1

Switching times

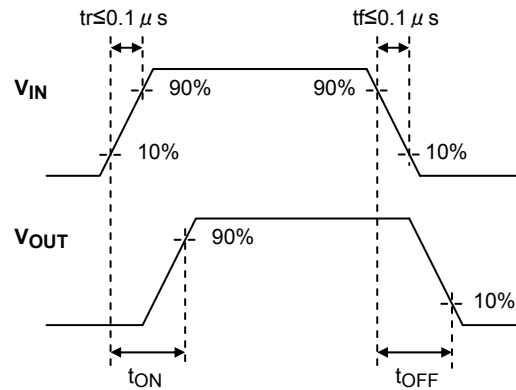
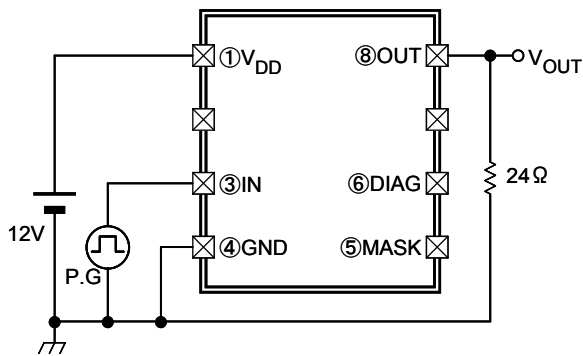

Application circuit

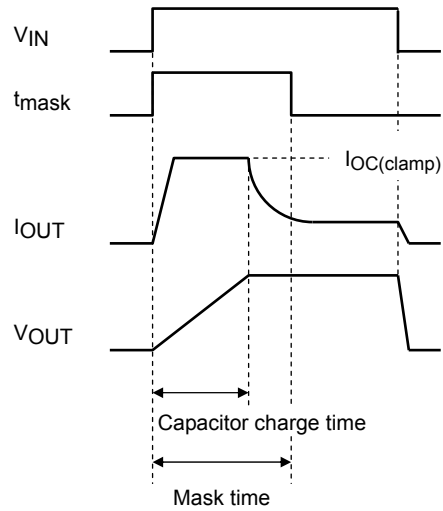
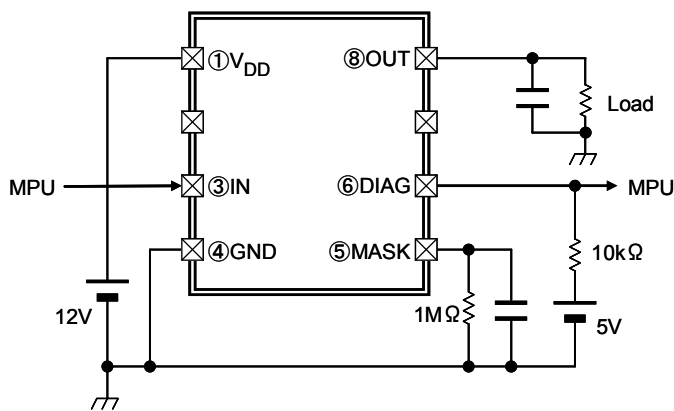

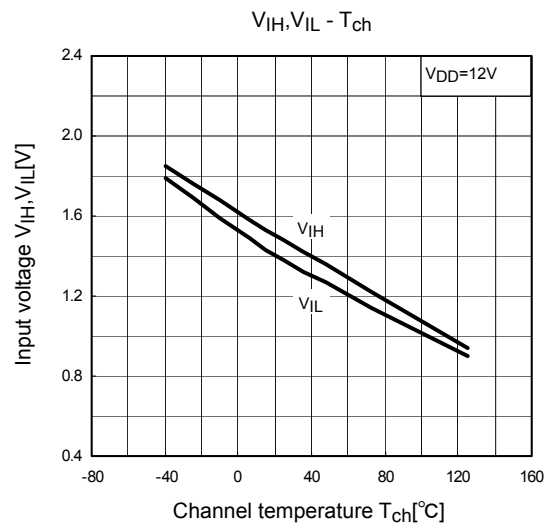
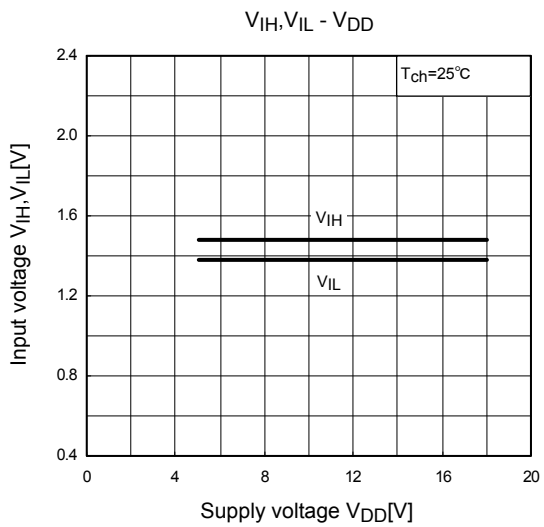
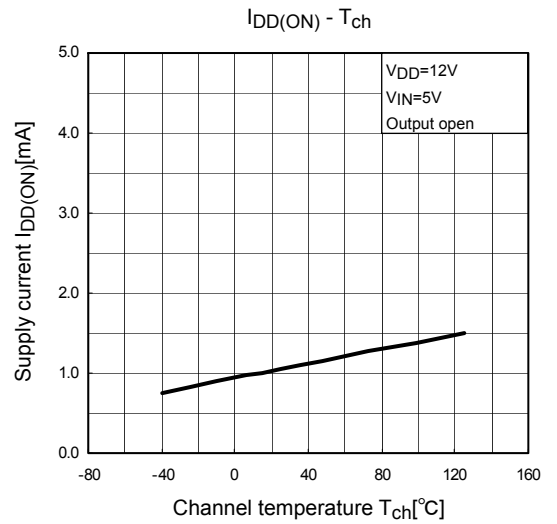
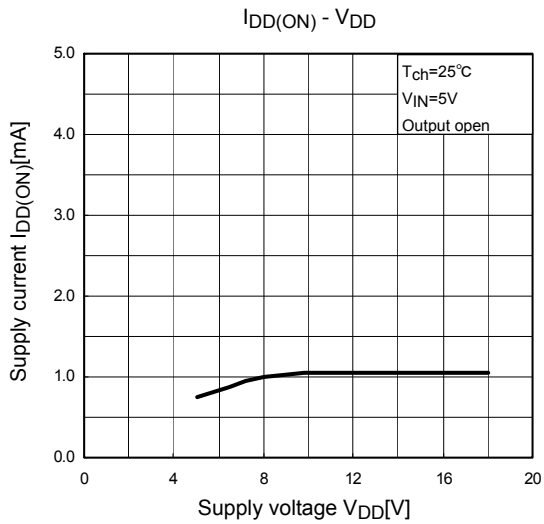
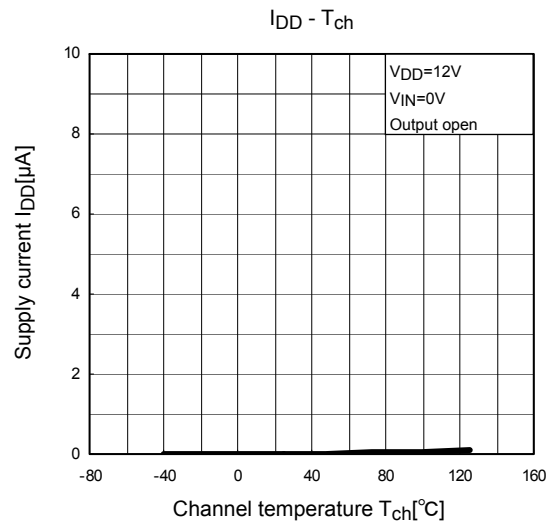
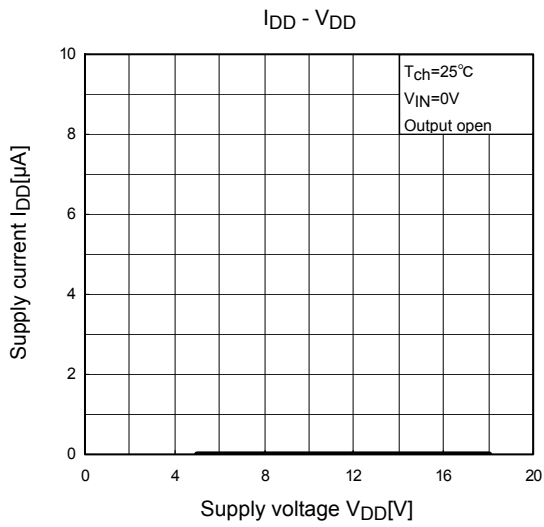

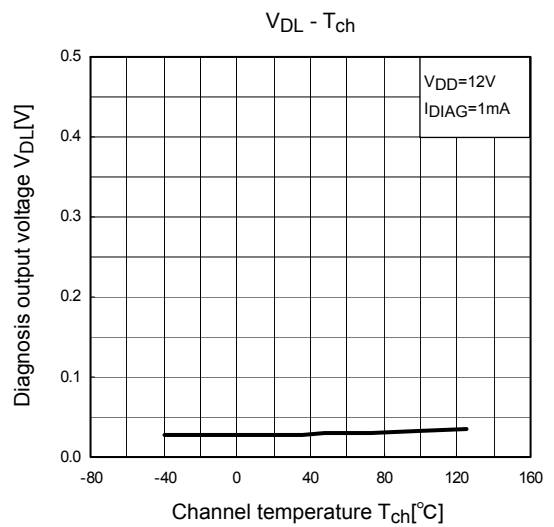
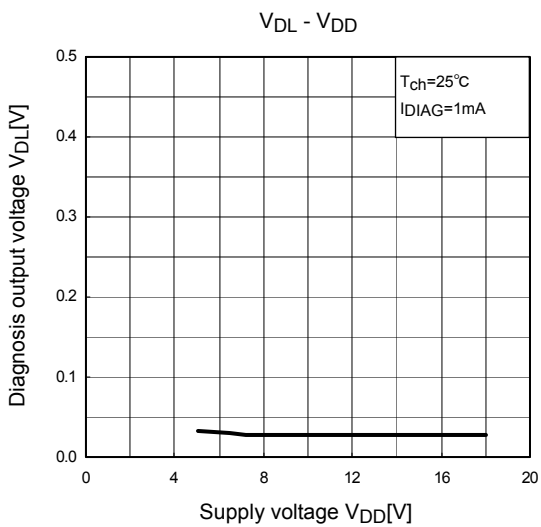
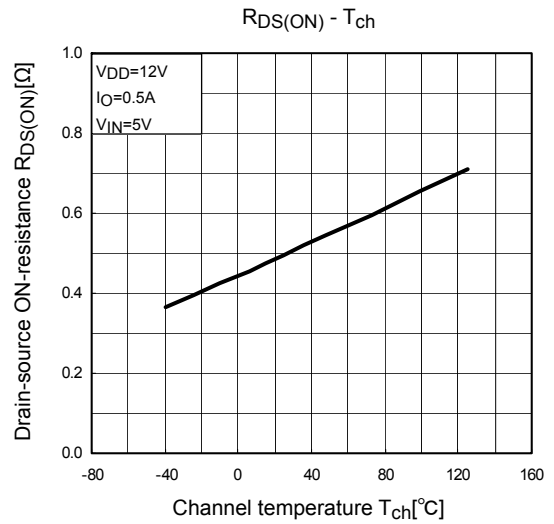
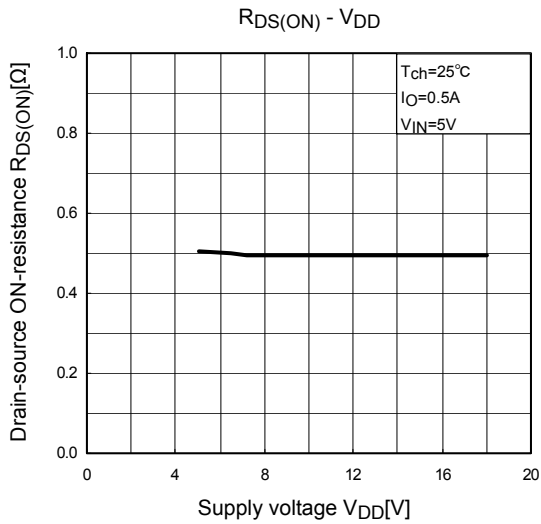
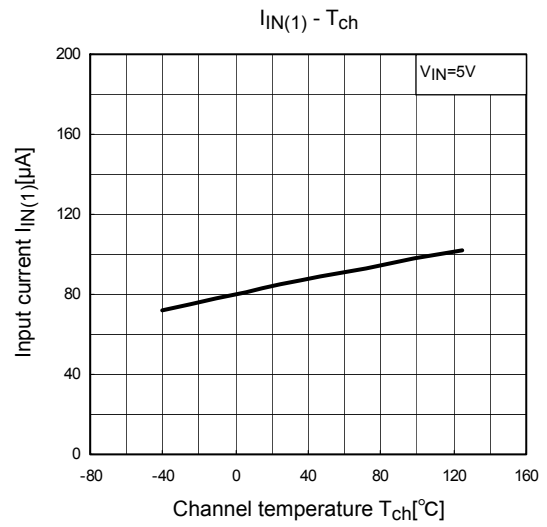
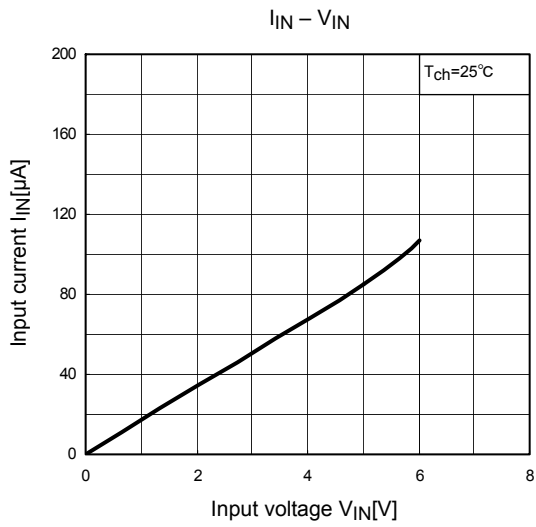

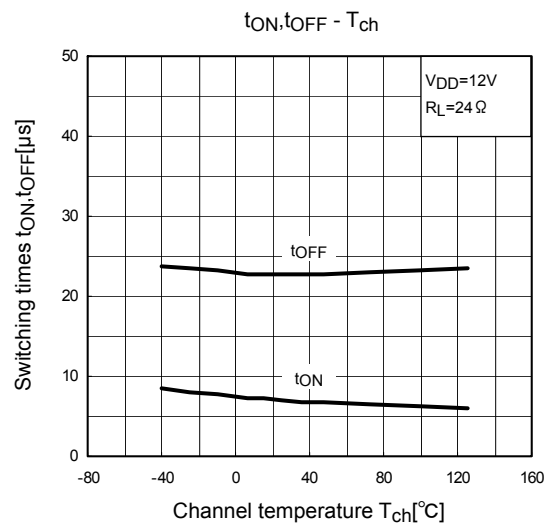
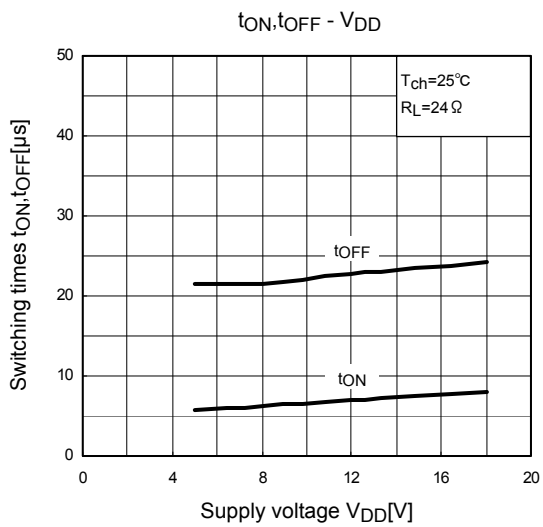
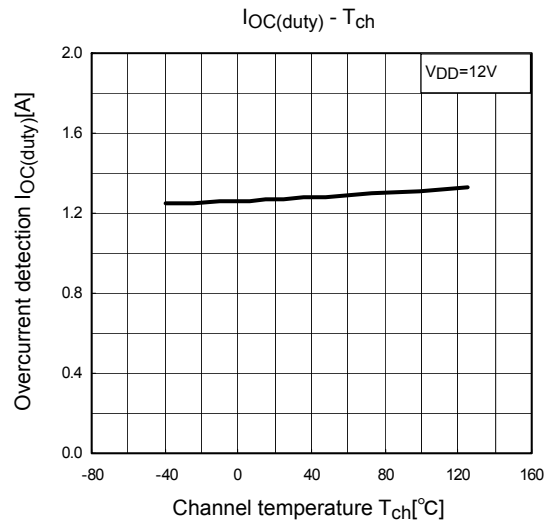
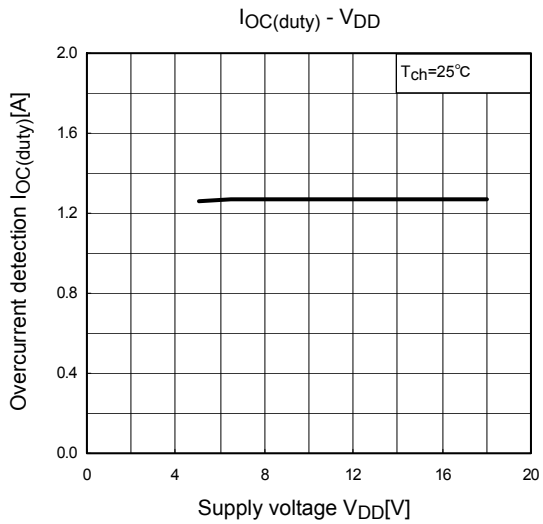
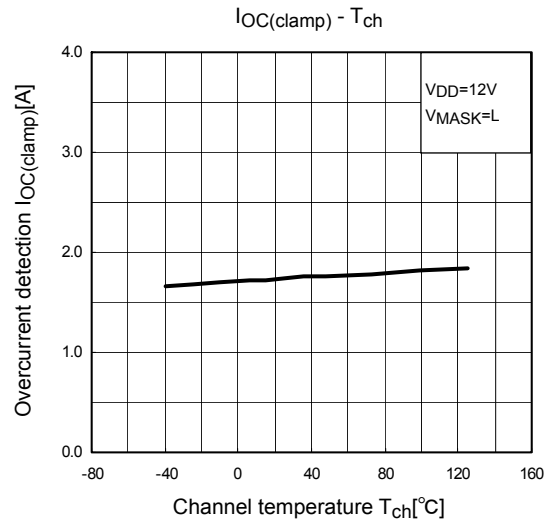
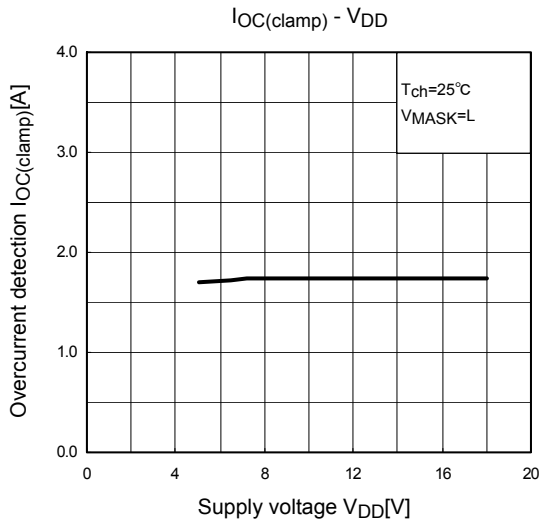

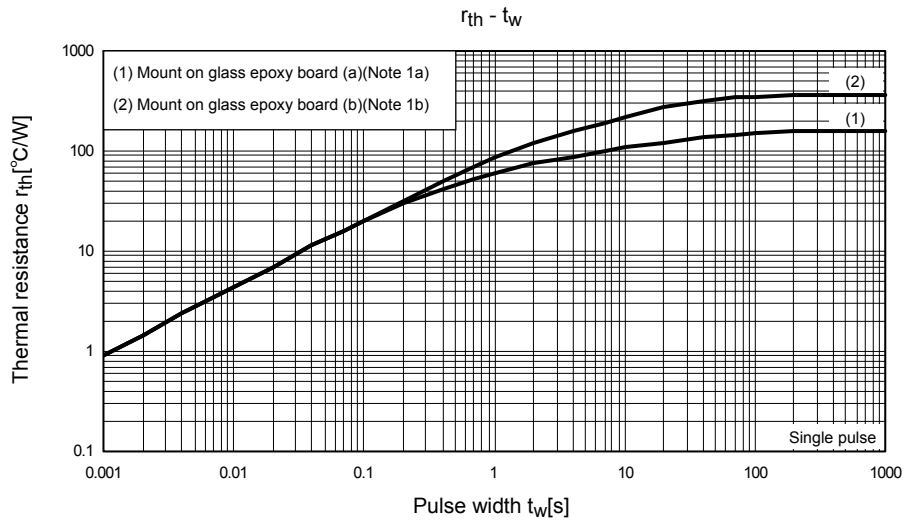
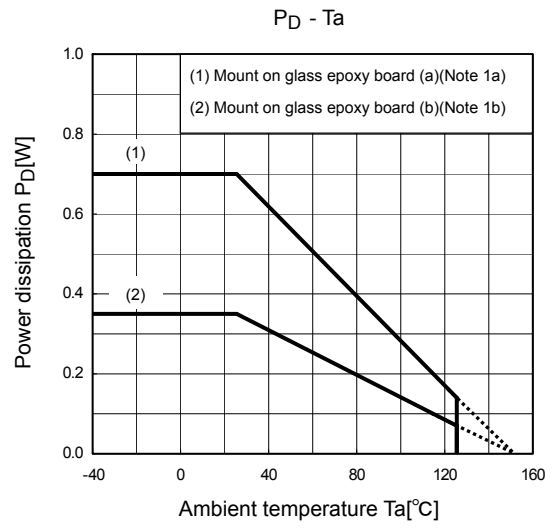
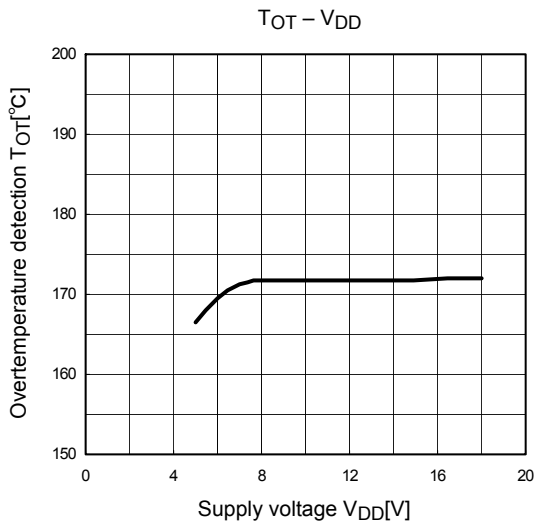

Package Dimensions

Unit; mm

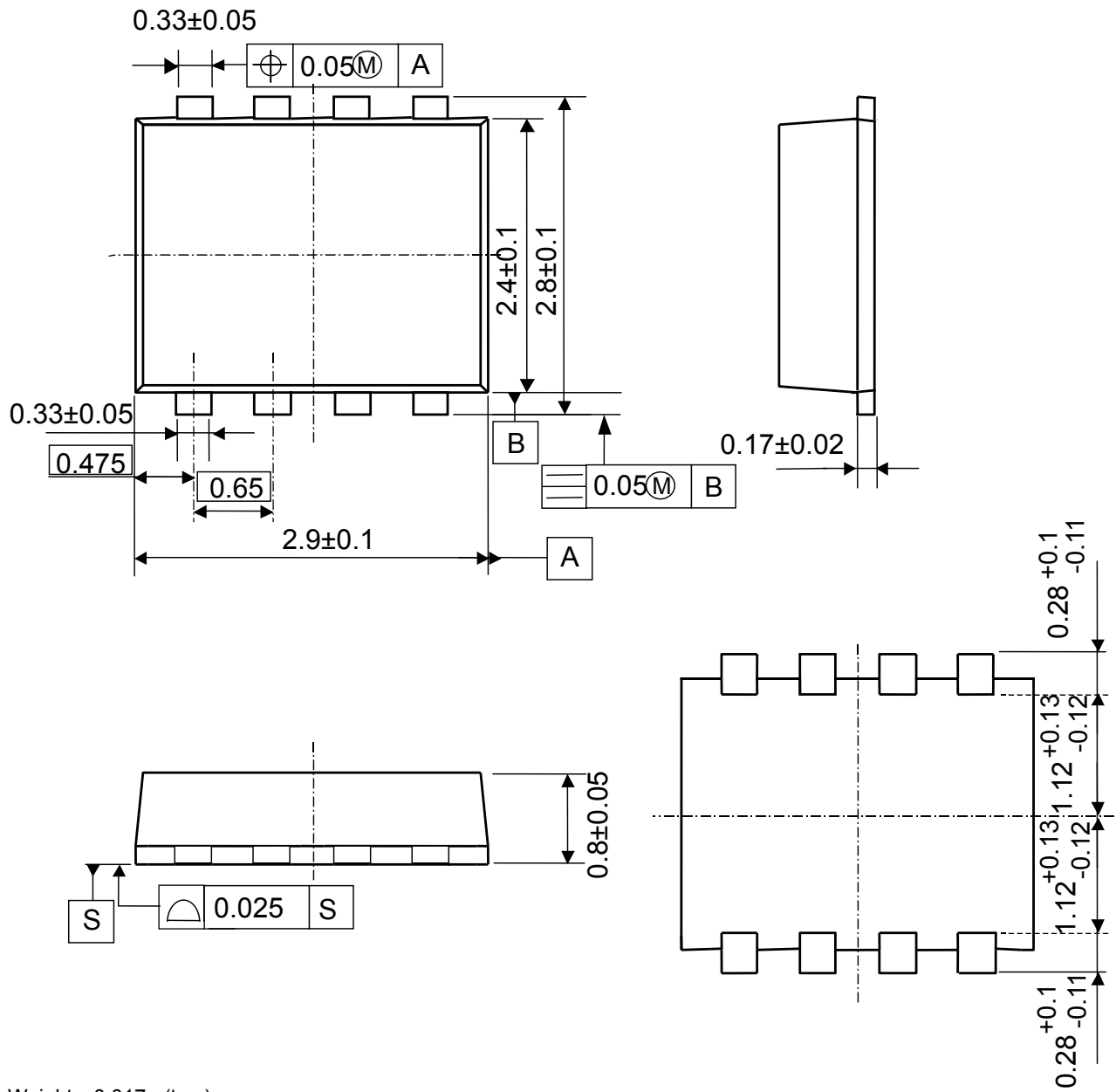

Weight : 0.017g (typ.)

RESTRICTIONS ON PRODUCT USE

- Toshiba Corporation, and its subsidiaries and affiliates (collectively "TOSHIBA"), reserve the right to make changes to the information in this document, and related hardware, software and systems (collectively "Product") without notice.
- This document and any information herein may not be reproduced without prior written permission from TOSHIBA. Even with TOSHIBA's written permission, reproduction is permissible only if reproduction is without alteration/omission.
- Though TOSHIBA works continually to improve Product's quality and reliability, Product can malfunction or fail. Customers are responsible for complying with safety standards and for providing adequate designs and safeguards for their hardware, software and systems which minimize risk and avoid situations in which a malfunction or failure of Product could cause loss of human life, bodily injury or damage to property, including data loss or corruption. Before customers use the Product, create designs including the Product, or incorporate the Product into their own applications, customers must also refer to and comply with (a) the latest versions of all relevant TOSHIBA information, including without limitation, this document, the specifications, the data sheets and application notes for Product and the precautions and conditions set forth in the "TOSHIBA Semiconductor Reliability Handbook" and (b) the instructions for the application with which the Product will be used with or for. Customers are solely responsible for all aspects of their own product design or applications, including but not limited to (a) determining the appropriateness of the use of this Product in such design or applications; (b) evaluating and determining the applicability of any information contained in this document, or in charts, diagrams, programs, algorithms, sample application circuits, or any other referenced documents; and (c) validating all operating parameters for such designs and applications. **TOSHIBA ASSUMES NO LIABILITY FOR CUSTOMERS' PRODUCT DESIGN OR APPLICATIONS.**
- **PRODUCT IS NEITHER INTENDED NOR WARRANTED FOR USE IN EQUIPMENTS OR SYSTEMS THAT REQUIRE EXTRAORDINARILY HIGH LEVELS OF QUALITY AND/OR RELIABILITY, AND/OR A MALFUNCTION OR FAILURE OF WHICH MAY CAUSE LOSS OF HUMAN LIFE, BODILY INJURY, SERIOUS PROPERTY DAMAGE AND/OR SERIOUS PUBLIC IMPACT ("UNINTENDED USE").** Except for specific applications as expressly stated in this document, Unintended Use includes, without limitation, equipment used in nuclear facilities, equipment used in the aerospace industry, medical equipment, equipment used for automobiles, trains, ships and other transportation, traffic signaling equipment, equipment used to control combustions or explosions, safety devices, elevators and escalators, devices related to electric power, and equipment used in finance-related fields. **IF YOU USE PRODUCT FOR UNINTENDED USE, TOSHIBA ASSUMES NO LIABILITY FOR PRODUCT.** For details, please contact your TOSHIBA sales representative.
- Do not disassemble, analyze, reverse-engineer, alter, modify, translate or copy Product, whether in whole or in part.
- Product shall not be used for or incorporated into any products or systems whose manufacture, use, or sale is prohibited under any applicable laws or regulations.
- The information contained herein is presented only as guidance for Product use. No responsibility is assumed by TOSHIBA for any infringement of patents or any other intellectual property rights of third parties that may result from the use of Product. No license to any intellectual property right is granted by this document, whether express or implied, by estoppel or otherwise.
- **ABSENT A WRITTEN SIGNED AGREEMENT, EXCEPT AS PROVIDED IN THE RELEVANT TERMS AND CONDITIONS OF SALE FOR PRODUCT, AND TO THE MAXIMUM EXTENT ALLOWABLE BY LAW, TOSHIBA (1) ASSUMES NO LIABILITY WHATSOEVER, INCLUDING WITHOUT LIMITATION, INDIRECT, CONSEQUENTIAL, SPECIAL, OR INCIDENTAL DAMAGES OR LOSS, INCLUDING WITHOUT LIMITATION, LOSS OF PROFITS, LOSS OF OPPORTUNITIES, BUSINESS INTERRUPTION AND LOSS OF DATA, AND (2) DISCLAIMS ANY AND ALL EXPRESS OR IMPLIED WARRANTIES AND CONDITIONS RELATED TO SALE, USE OF PRODUCT, OR INFORMATION, INCLUDING WARRANTIES OR CONDITIONS OF MERCHANTABILITY, FITNESS FOR A PARTICULAR PURPOSE, ACCURACY OF INFORMATION, OR NONINFRINGEMENT.**
- Do not use or otherwise make available Product or related software or technology for any military purposes, including without limitation, for the design, development, use, stockpiling or manufacturing of nuclear, chemical, or biological weapons or missile technology products (mass destruction weapons). Product and related software and technology may be controlled under the applicable export laws and regulations including, without limitation, the Japanese Foreign Exchange and Foreign Trade Law and the U.S. Export Administration Regulations. Export and re-export of Product or related software or technology are strictly prohibited except in compliance with all applicable export laws and regulations.
- Please contact your TOSHIBA sales representative for details as to environmental matters such as the RoHS compatibility of Product. Please use Product in compliance with all applicable laws and regulations that regulate the inclusion or use of controlled substances, including without limitation, the EU RoHS Directive. **TOSHIBA ASSUMES NO LIABILITY FOR DAMAGES OR LOSSES OCCURRING AS A RESULT OF NONCOMPLIANCE WITH APPLICABLE LAWS AND REGULATIONS.**

X-ON Electronics

Largest Supplier of Electrical and Electronic Components

Click to view similar products for [Gate Drivers](#) category:

Click to view products by [Toshiba](#) manufacturer:

Other Similar products are found below :

[00053P0231](#) [56956](#) [57.404.7355.5](#) [LT4936](#) [57.904.0755.0](#) [5811-0902](#) [5882900001](#) [00600P0005](#) [00-9050-LRPP](#) [00-9090-RDPP](#)
[5951900000](#) [0131700000](#) [00-2240](#) [LTP70N06](#) [LVP640](#) [5J0-1000LG-SIL](#) [LY2-US-AC240](#) [LY3-UA-DC24](#) [00576P0020](#) [00600P0010](#)
[LZN4-UA-DC12](#) [LZNQ2M-US-DC5](#) [LZNQ2-US-DC12](#) [LZP40N10](#) [00-8196-RDPP](#) [00-8274-RDPP](#) [00-8275-RDNP](#) [00-8609-RDPP](#) [00-](#)
[8722-RDPP](#) [00-8728-WHPP](#) [00-8869-RDPP](#) [00-9051-RDPP](#) [00-9091-LRPP](#) [00-9291-RDPP](#) [0207100000](#) [0207400000](#) [60100564](#) [60249-1-](#)
[CUT-TAPE](#) [0134220000](#) [60713816](#) [M15730061](#) [61161-90](#) [61278-0020](#) [6131-204-23149P](#) [6131-205-17149P](#) [6131-209-15149P](#) [6131-218-](#)
[17149P](#) [6131-220-21149P](#) [6131-260-2358P](#) [6131-265-11149P](#)