

Toshiba Intelligent Power Device Silicon Monolithic MOS Integrated Circuit

# TPD2015FN

High side power switch array (8-channels) for motors, solenoids, lamp drives

## 1. Description

TPD2015FN is a high-side switch array (8-channels) with MOSFET outputs. This is the monolithic power IC that can be driven directly from CMOS, TTL logic circuitry (MCU, etc.) and have over current and over temperature protection features.

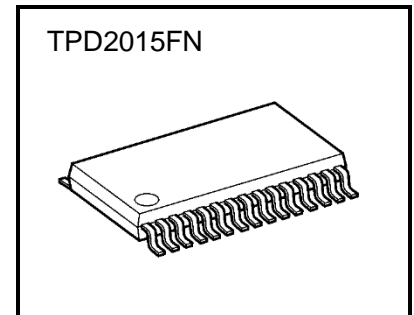

SSOP30-P-300-0.65

## 2. Applications

- Programmable logic controller for Industrial Use.
- Driving resistant load and inductive load

## 3. Features

- 8-channels of N-channel MOSFET and charge pump are built-in.
- This IC can drive the power load directly.
- Built-in protection against over temperature and over current.
- 8-channels access enables space-saving design.
- High voltage operation is possible : 40 V
- Low on resistance :  $0.55\Omega$  (max) @  $V_{DD} = 12V$ ,  $I_{OUT} = 0.5A$ ,  $T_j = 25^\circ C$  (per channel)
- Parallel operation is possible.
- Package is SSOP30 (300 mil) and packing form is embossed taping.

Note: This product has a MOS structure and is sensitive to electrostatic discharge.

Start of commercial production  
2022-05

## 4. Block Diagram

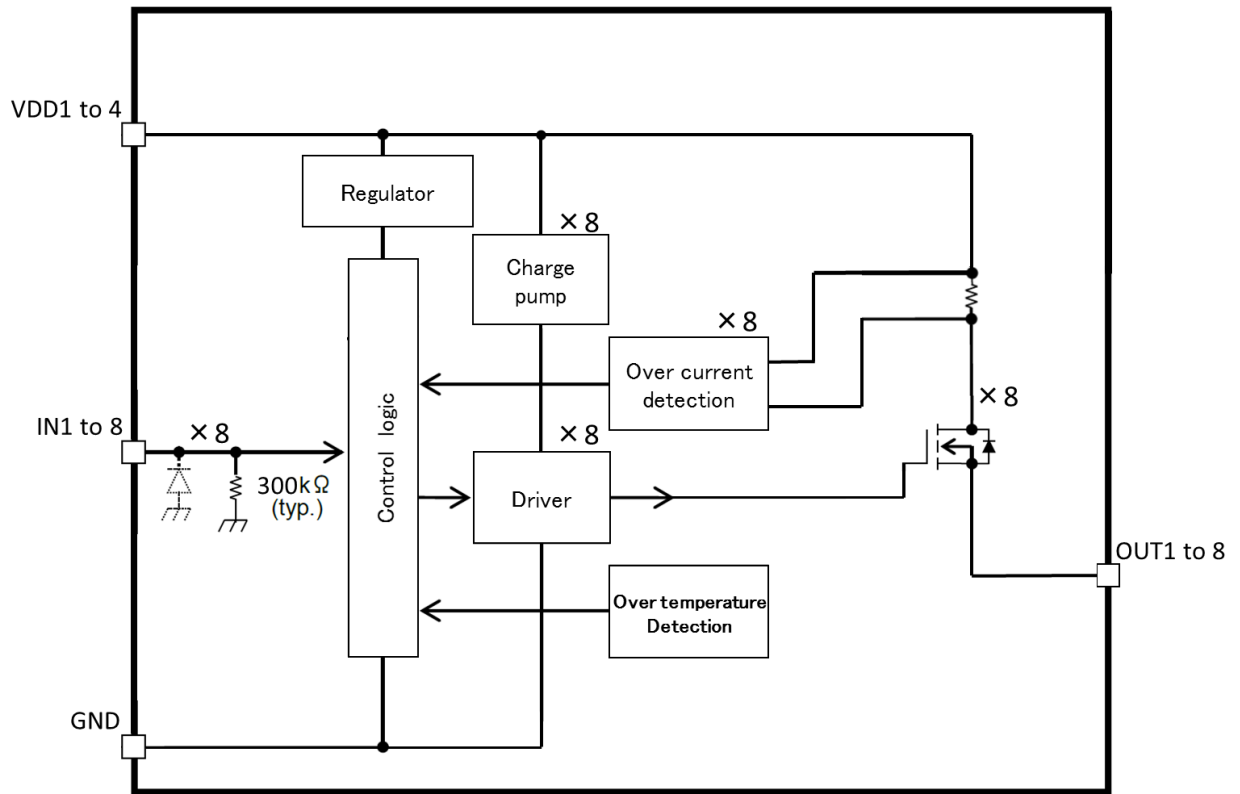

Note: Some of the functional blocks, circuits, constants, etc. in the block diagram are omitted or simplified.

**Figure 4.1 Block Diagram**

## 5. Pin Assignments

(TOP VIEW)

VDD1	1		30	NC
VDD2	2		29	NC
NC	3		28	NC
GND	4		27	NC
IN1	5		26	OUT1
IN2	6		25	OUT2
IN3	7		24	OUT3
IN4	8		23	OUT4
IN5	9		22	OUT5
IN6	10		21	OUT6
IN7	11		20	OUT7
IN8	12		19	OUT8
NC	13		18	NC
VDD3	14		17	NC
VDD4	15		16	NC

**Figure 5.1 Pin Assignments**

## 6. Pin Description

Table 6.1 Pin Description

Pin No.	Symbol	I/O	Pin Description
1	VDD1	-	Power supply pin.
2	VDD2	-	Power supply pin.
3	NC	-	No-Connect pin.
4	GND	-	GND pin.
5	IN1	IN	Input pin for channel 1. Built in pull down resistor (300kΩ typ.).
6	IN2	IN	Input pin for channel 2. Built in pull down resistor (300kΩ typ.).
7	IN3	IN	Input pin for channel 3. Built in pull down resistor (300kΩ typ.).
8	IN4	IN	Input pin for channel 4. Built in pull down resistor (300kΩ typ.).
9	IN5	IN	Input pin for channel 5. Built in pull down resistor (300kΩ typ.).
10	IN6	IN	Input pin for channel 6. Built in pull down resistor (300kΩ typ.).
11	IN7	IN	Input pin for channel 7. Built in pull down resistor (300kΩ typ.).
12	IN8	IN	Input pin for channel 8. Built in pull down resistor (300kΩ typ.).
13	NC	-	No-Connect pin.
14	VDD3	-	Power supply pin.
15	VDD4	-	Power supply pin.
16	NC	-	No-Connect pin.
17	NC	-	No-Connect pin.
18	NC	-	No-Connect pin.
19	OUT8	OUT	Output pin of channel 8.
20	OUT7	OUT	Output pin of channel 7.
21	OUT6	OUT	Output pin of channel 6.
22	OUT5	OUT	Output pin of channel 5.
23	OUT4	OUT	Output pin of channel 4.
24	OUT3	OUT	Output pin of channel 3.
25	OUT2	OUT	Output pin of channel 2.
26	OUT1	OUT	Output pin of channel 1.
27	NC	-	No-Connect pin.
28	NC	-	No-Connect pin.
29	NC	-	No-Connect pin.
30	NC	-	No-Connect pin.

## 7. Operational Description

### 7.1. Over temperature protection

To prevent damage due to temperature rise, the outputs are turned off when the junction temperature of this product exceeds the over temperature detection temperature ( $T_{SD}$ ). If the junction temperature falls below the hysteresis set temperature ( $T_{SD}-\Delta T_{SD}$ ), the product will return to normal operation.

### 7.2. Over current protection

When the output current exceeds the over current detection value ( $I_{OC}$ ) due to a load short circuit, etc., the output is turned off during the over current protection operating time ( $t_{OFF-DUTY}$ ). After that, the output returns, but if the over current condition continues, the output is turned off again for the over current protection operating time ( $t_{OFF-DUTY}$ ).

### 7.3. Timing chart

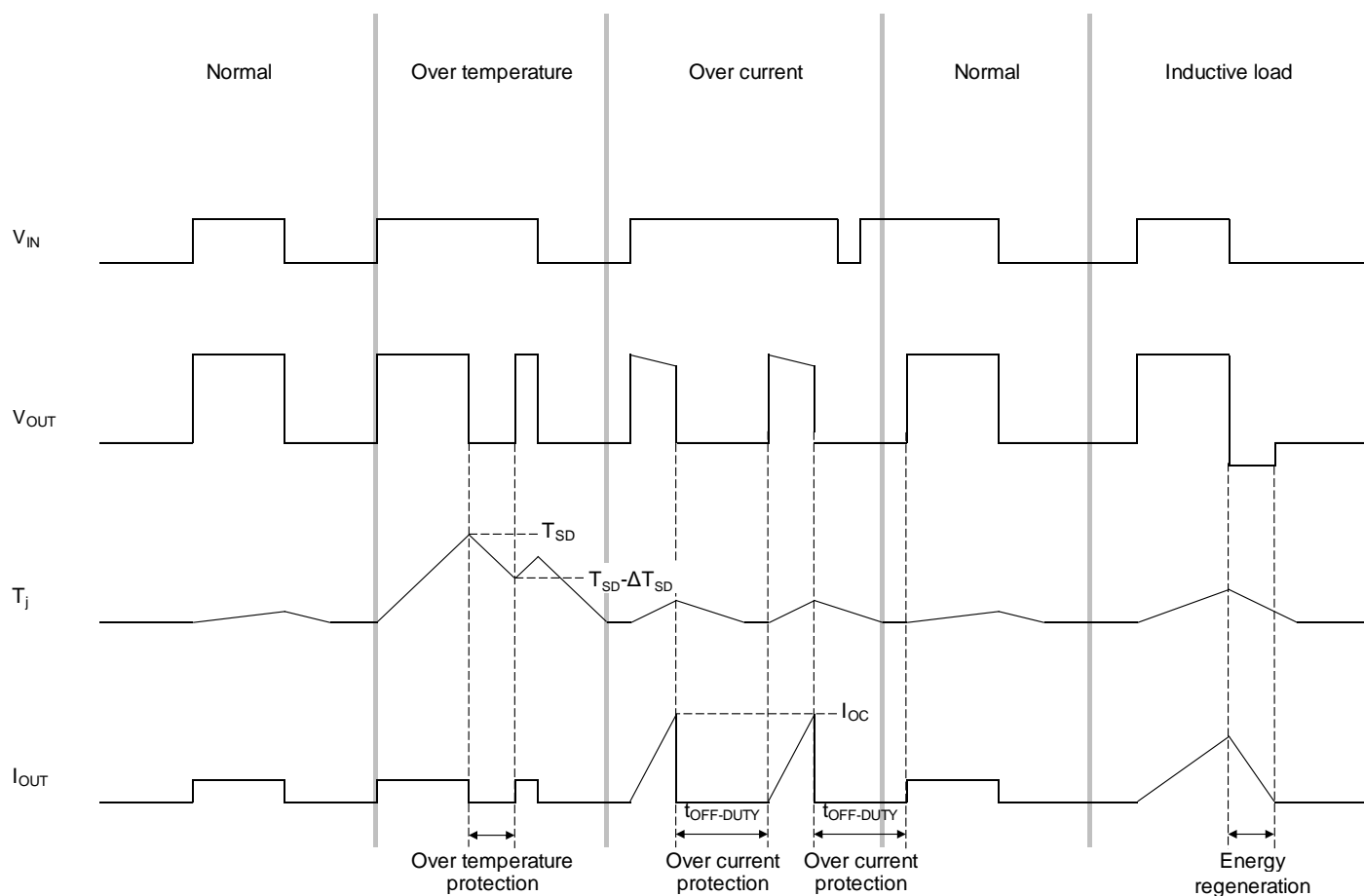

Figure 7.1 Timing chart

## 7.4. Truth table

Table 7.1 Truth table

Input	Output	Operating state
L	L	Normal
H	H	
L	L	Over current protection ( Load short circuit )
H	Switching	
L	L	Over temperature protection
H	L	

## 8. Absolute Maximum Ratings

**Table 8.1 Absolute Maximum Ratings**

( $T_a = 25^\circ\text{C}$  unless otherwise specified)

Characteristics	Symbol	Rating	Unit
Supply voltage	$V_{DD}$	-0.3 to 40.0	V
Input voltage	$V_{IN}$	-0.3 to 6.0	V
VDDx - OUTx withstand voltage	$V_{DSS}$	50.0 <sup>1)</sup>	V
Output current	$I_{OUT}$	Internally limited	A
Power dissipation	$P_D$	1.8	W
Operating temperature	$T_{opr}$	-40 to 110	$^\circ\text{C}$
Junction temperature	$T_j$	150	$^\circ\text{C}$
Storage temperature	$T_{stg}$	-55 to 150	$^\circ\text{C}$

1) Not subject to production test.

Note: Using continuously under heavy loads (e.g. the application of high temperature/current/voltage and the significant change in temperature, etc.) may cause this product to decrease in the reliability significantly even if the operating conditions (i.e. operating temperature/current/voltage, etc.) are within the absolute maximum ratings and the operating ranges.

Please design the appropriate reliability upon reviewing the Toshiba Semiconductor Reliability Handbook ("Handling Precautions"/"Derating Concept and Methods") and individual reliability data (i.e. reliability test report and estimated failure rate, etc).

### 8.1. Thermal Resistance

**Table 8.2 Thermal resistance**

Characteristics	Symbol	Rating	Unit
Thermal resistance ( junction-to-ambient )	$R_{th(j-a)}$	70	$^\circ\text{C} / \text{W}$

Note: JEDEC Standard.  
 Glass epoxy board  
 Material: FR-4(4 layer)  
 Board size: 76.2mm x 114.3mm x 1.6mm

## 9. Operating Ranges

**Table 9.1 Operating supply voltage**

Characteristics	Symbol	Condition	Min	Typ.	Max	Unit
Operating supply voltage	$V_{DD(opr)}$	$T_j = 25^\circ\text{C}$	8	-	40	V

## 10. Electrical Characteristics

**Table 10.1 Electrical Characteristics**

 ( $T_j = 25^\circ\text{C}$ ,  $V_{DD} = 8$  to  $40\text{V}$  unless otherwise specified)

Characteristics		Symbol	Note or Test Condition	Min	Typ.	Max	Unit
Supply current		$I_{DD(OFF)}$	$V_{DD} = 24\text{V}$ , $V_{IN} = 0\text{V}$	-	1.9	2.6	mA
		$I_{DD(ON)}$	$V_{DD} = 24\text{V}$ , $V_{IN} = 5\text{V}$ , All outputs open	-	3.1	4.2	mA
Input voltage	“L” level	$V_{IL}$	-	-	-	0.8	V
	“H” level	$V_{IH}$	-	2.0	-	-	
Input current		$I_{IL}$	$V_{IN} = 0\text{V}$	-1	-	1	$\mu\text{A}$
		$I_{IH}$	$V_{IN} = 5\text{V}$	-	16	23	
On resistance		$R_{DS(ON)}$	$V_{DD} = 12\text{V}$ , $V_{IN} = 5\text{V}$ , $I_{OUT} = 0.5\text{A}$	-	0.40	0.55	$\Omega$
Output leakage current		$I_{OL}$	$V_{DD} = 40\text{V}$ , $V_{IN} = 0\text{V}$ , Per output	-	-	1	$\mu\text{A}$
Over current protection		$I_{OC}$	-	1.0	1.8	2.8	A
Over current protection operating time		$t_{OFF-DUTY}$	-	1.5	3.0	4.5	ms
Over temperature detection	Temperature	$T_{SD}$	-	150	175	200	$^\circ\text{C}$
	Hysteresis	$\Delta T_{SD}$	-	10	20	30	
Switching time		$t_{ON}$	Refer to test circuit 1	5	10	15	$\mu\text{s}$
		$t_{OFF}$		3	6	9	
Single pulse avalanche energy		$E_s$	$T_a = 25^\circ\text{C}$ , $I_{OUT} = 0.75\text{A}$ (1-channel operation)	30	150 <sup>2)</sup>	-	mJ

2) Not subject to production test.



## 11. Test circuit

### 11.1. Test circuit 1

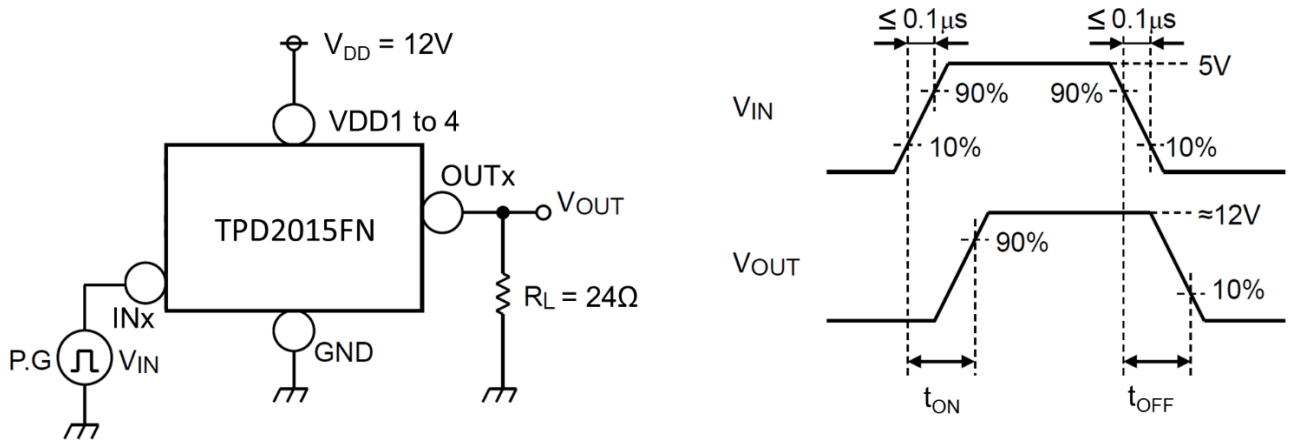
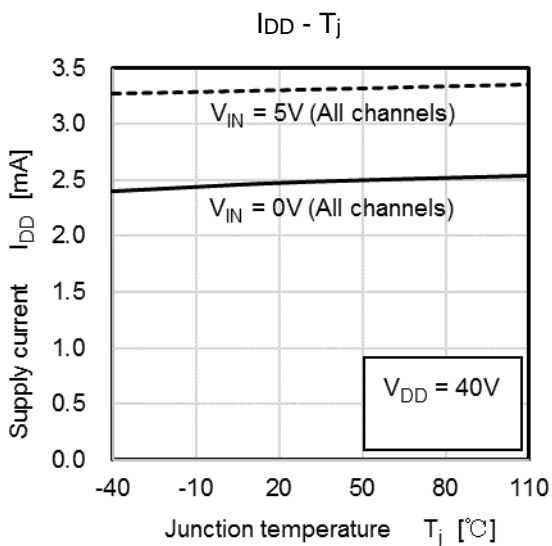
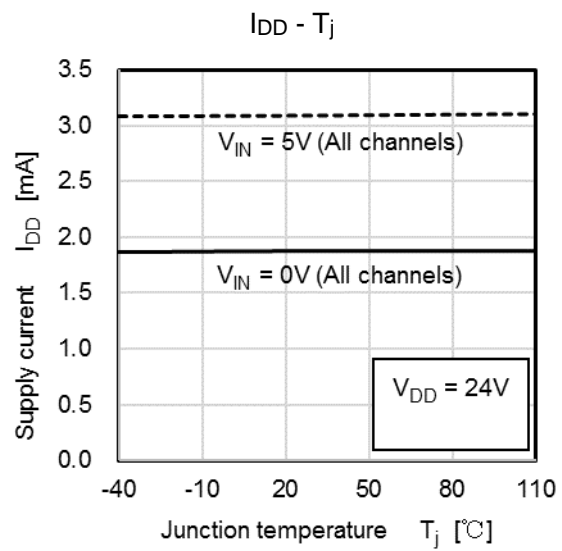
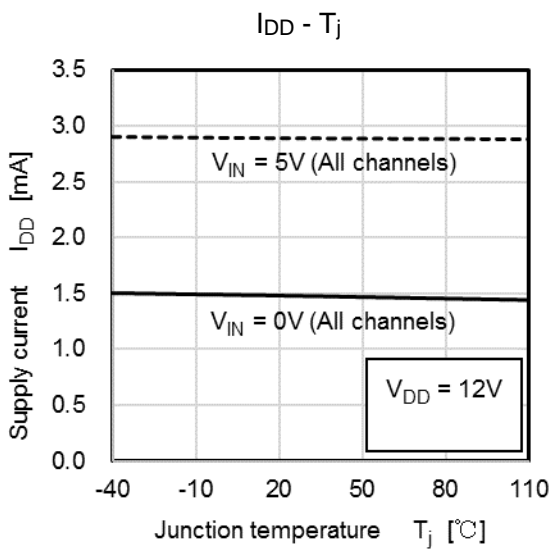
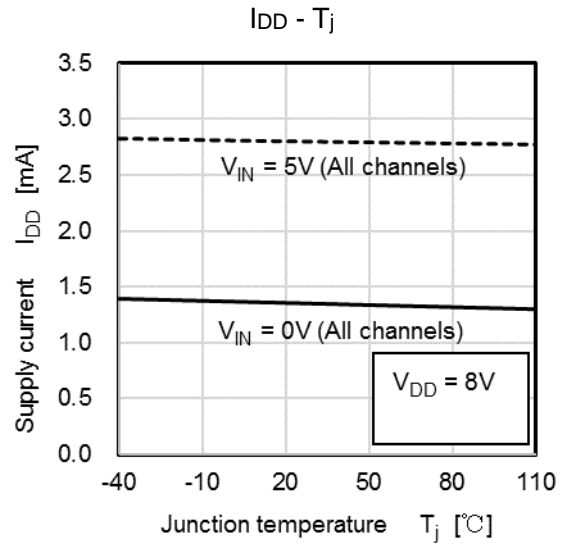
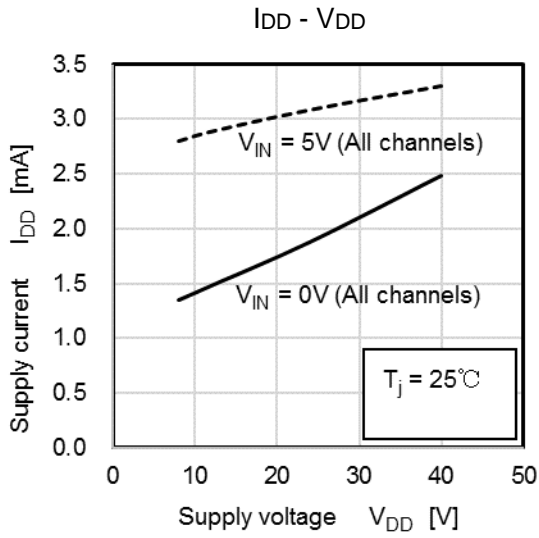
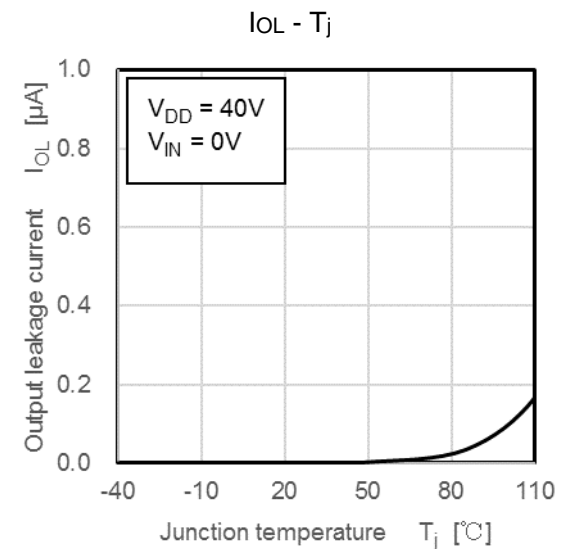
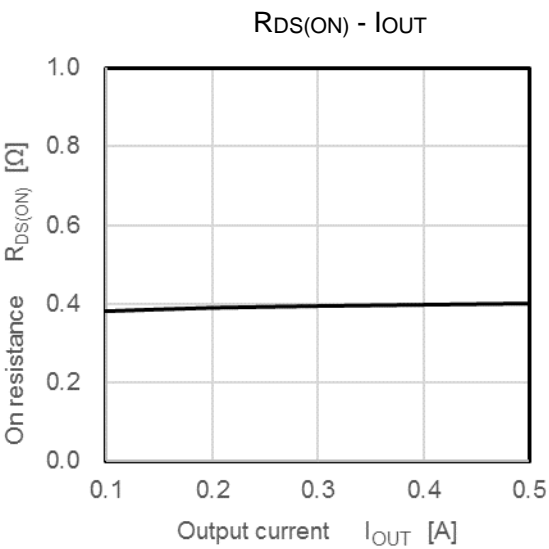
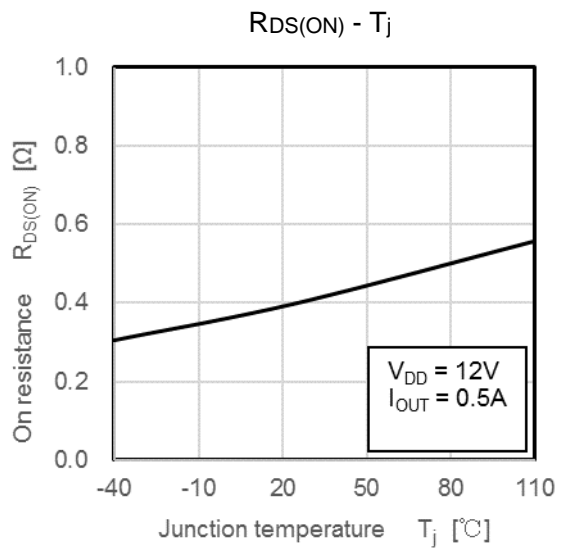
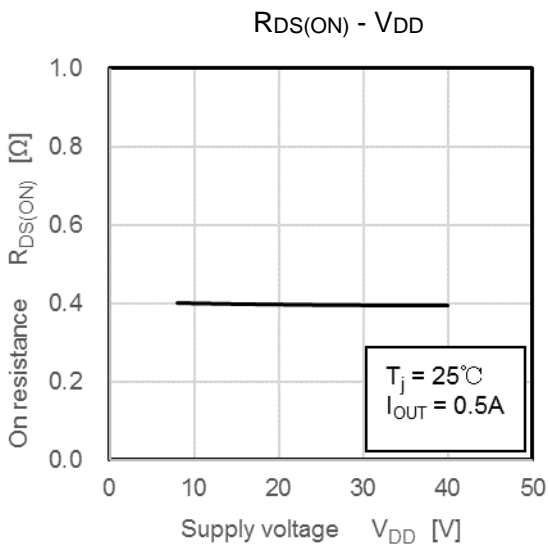
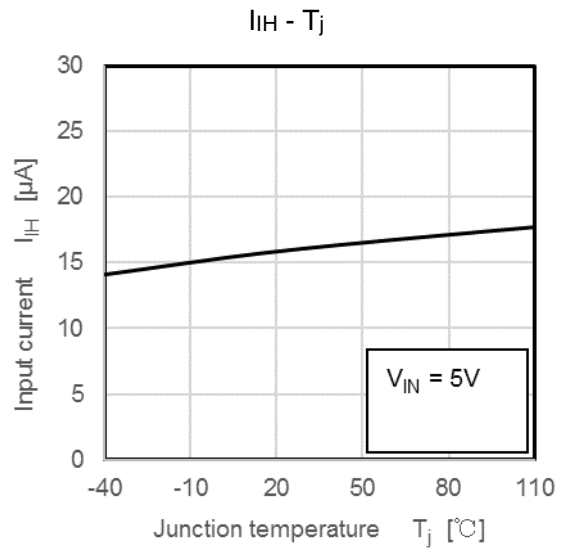
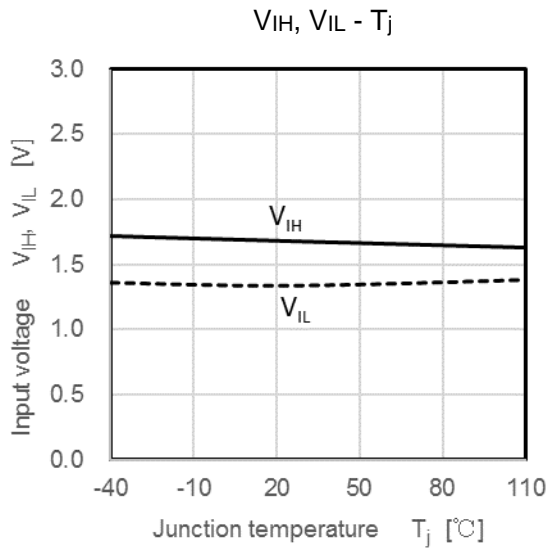

Figure 11.1 Switching time measurement circuit

## 12. Characteristic curves

The below characteristics curves are presented for reference only and not guaranteed by production test, unless otherwise noted.





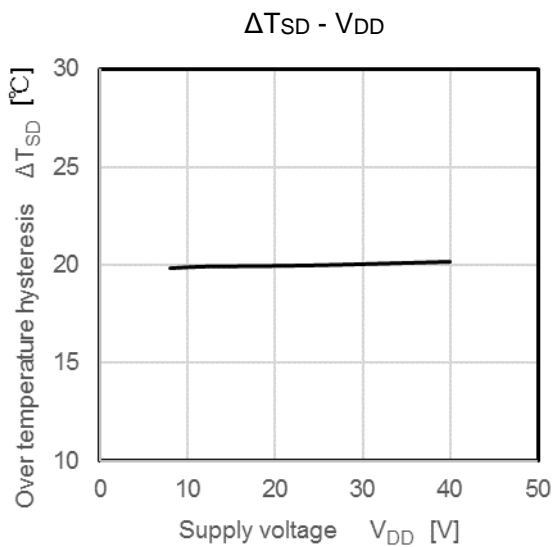
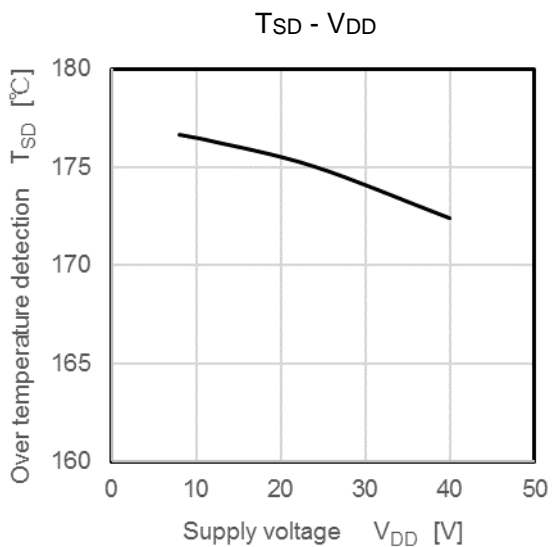
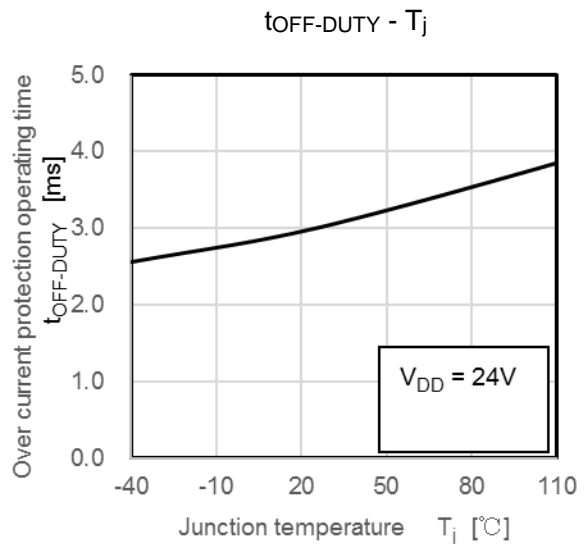
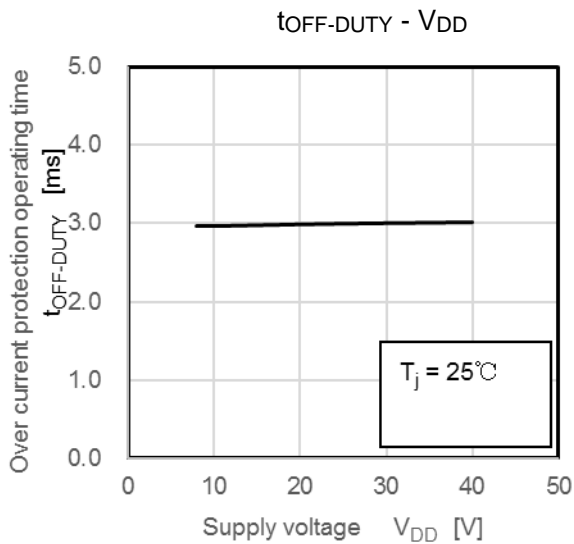
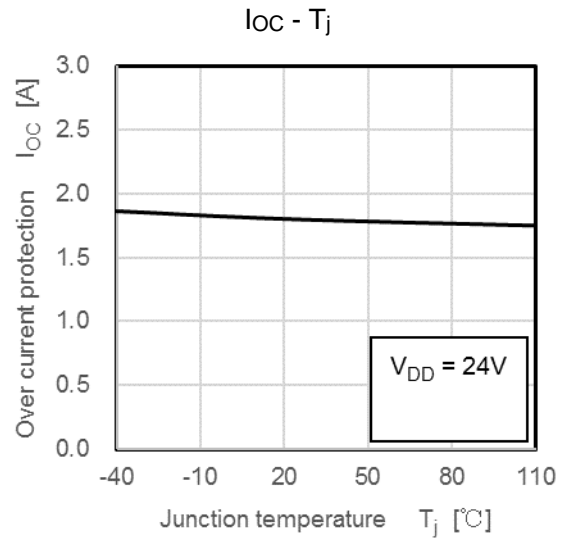
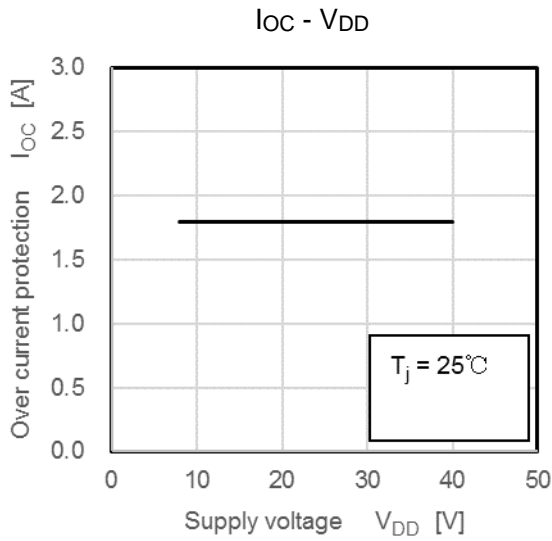

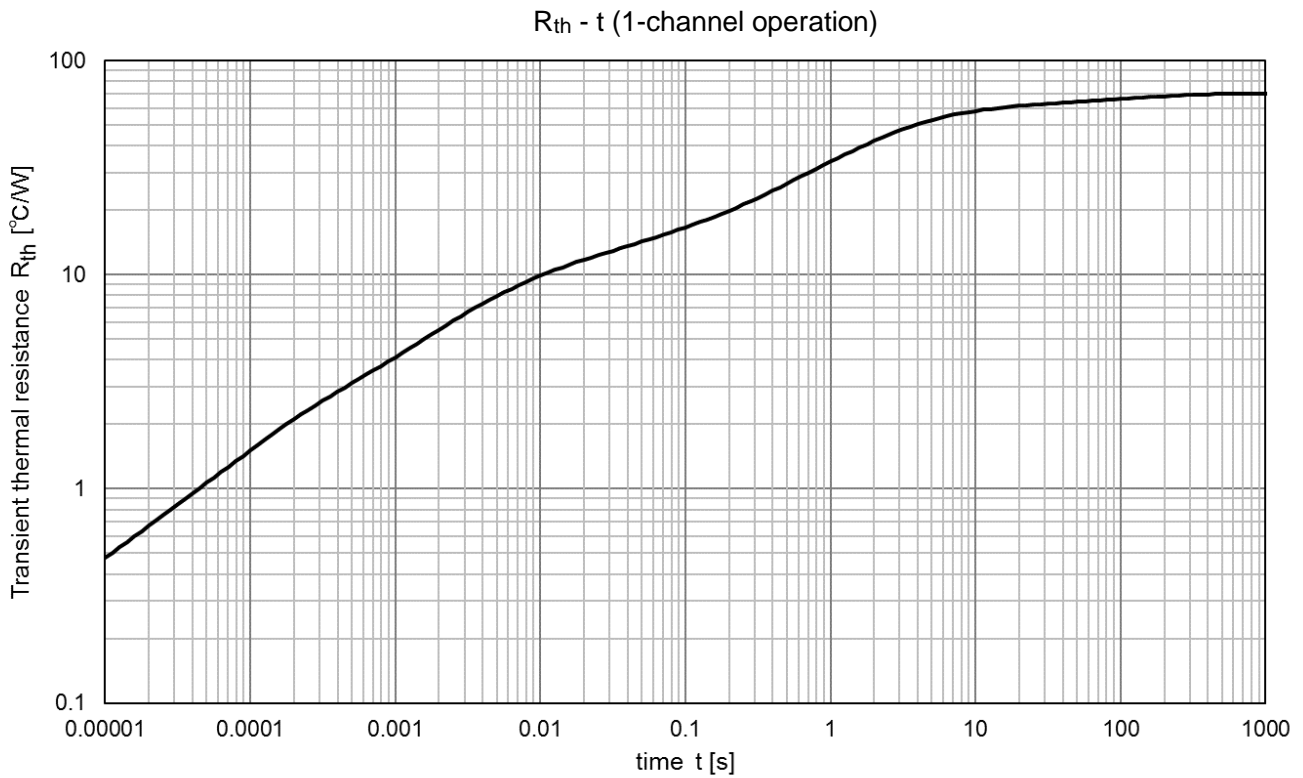
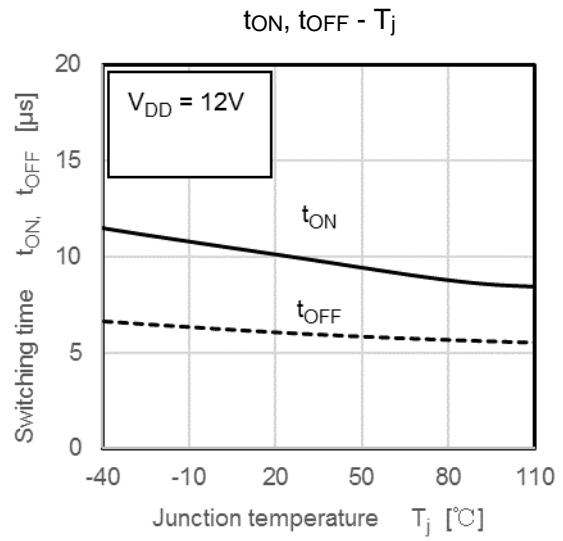
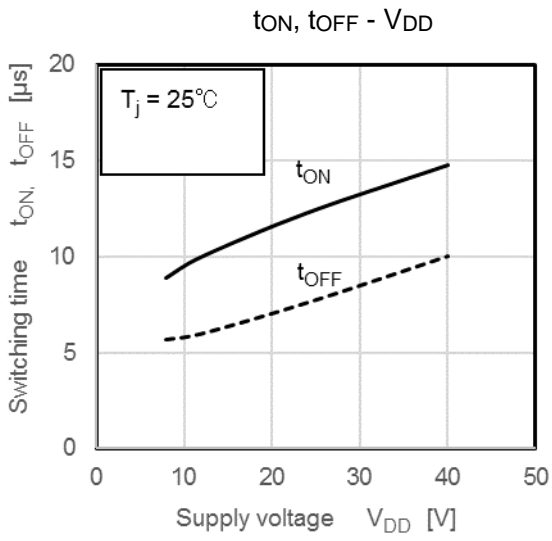

## 13. Package Information

### 13.1. Package Dimensions

Unit: mm

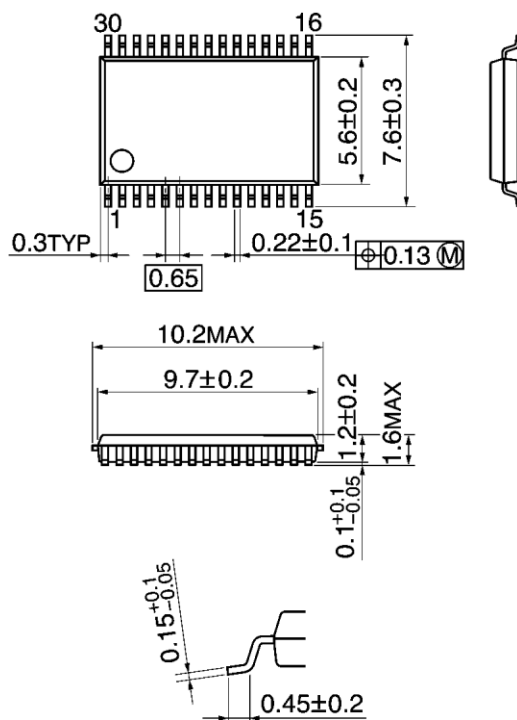

Weight: 0.176 g (Typ.)

Figure 13.1 Package Dimensions

**13.2. Marking**

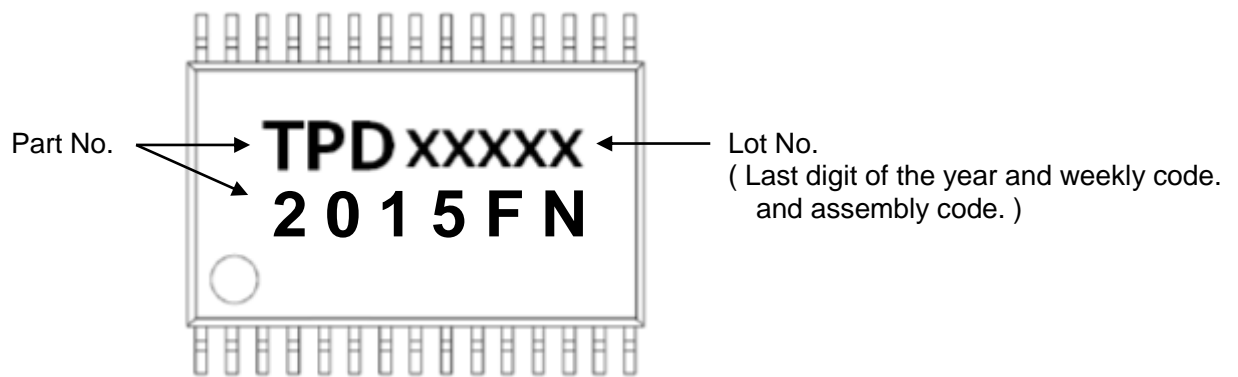
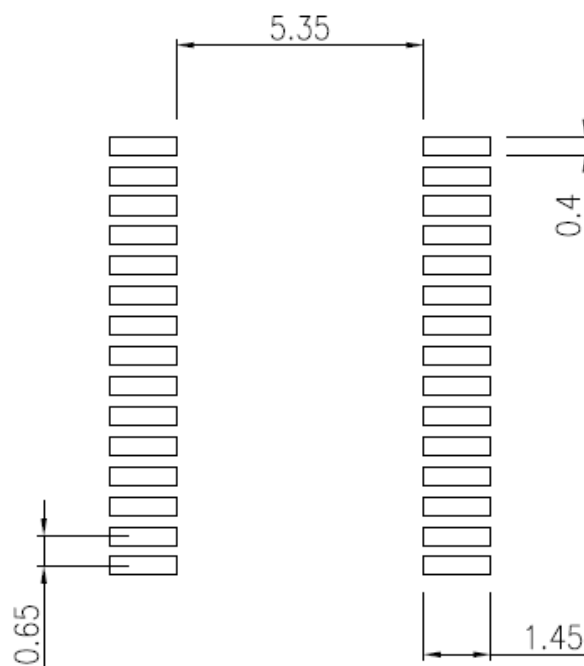

**Figure 13.2 Marking**

**13.3. Land Pattern Dimensions for Reference only**

SSOP30-P-300-0.65

"Unit: mm"



**Figure 13.3 Land Pattern Dimensions for Reference only**

---

## 14. IC Usage Considerations

### 14.1. Notes on handling of ICs

The absolute maximum ratings of a semiconductor device are a set of ratings that must not be exceeded, even for a moment.

Since the power supply reverse connection protection is not built-in, take measures with an external circuit.

Since the negative bias protection circuit of the output terminal is not built-in, when a negative bias is applied to the output terminal, be sure to connect a diode for back electromotive voltage absorption (FWD) between OUT and GND.

### 14.2. Notes on moisture-proof packaging

After opening the moisture-proof package, mount it within 168 hours in an environment of 30 °C and RH 60% or less.

Since it cannot be baked due to embossing, be sure to use it within the permissible range after opening the moisture-proof packaging.

The standard packing quantity for taping is 2000 pieces / reel.



---

## RESTRICTIONS ON PRODUCT USE

Toshiba Corporation and its subsidiaries and affiliates are collectively referred to as "TOSHIBA". Hardware, software and systems described in this document are collectively referred to as "Product".

- TOSHIBA reserves the right to make changes to the information in this document and related Product without notice.
- This document and any information herein may not be reproduced without prior written permission from TOSHIBA. Even with TOSHIBA's written permission, reproduction is permissible only if reproduction is without alteration/omission.
- Though TOSHIBA works continually to improve Product's quality and reliability, Product can malfunction or fail. Customers are responsible for complying with safety standards and for providing adequate designs and safeguards for their hardware, software and systems which minimize risk and avoid situations in which a malfunction or failure of Product could cause loss of human life, bodily injury or damage to property, including data loss or corruption. Before customers use the Product, create designs including the Product, or incorporate the Product into their own applications, customers must also refer to and comply with (a) the latest versions of all relevant TOSHIBA information, including without limitation, this document, the specifications, the data sheets and application notes for Product and the precautions and conditions set forth in the "TOSHIBA Semiconductor Reliability Handbook" and (b) the instructions for the application with which the Product will be used with or for. Customers are solely responsible for all aspects of their own product design or applications, including but not limited to (a) determining the appropriateness of the use of this Product in such design or applications; (b) evaluating and determining the applicability of any information contained in this document, or in charts, diagrams, programs, algorithms, sample application circuits, or any other referenced documents; and (c) validating all operating parameters for such designs and applications. **TOSHIBA ASSUMES NO LIABILITY FOR CUSTOMERS' PRODUCT DESIGN OR APPLICATIONS.**
- **PRODUCT IS NEITHER INTENDED NOR WARRANTED FOR USE IN EQUIPMENTS OR SYSTEMS THAT REQUIRE EXTRAORDINARILY HIGH LEVELS OF QUALITY AND/OR RELIABILITY, AND/OR A MALFUNCTION OR FAILURE OF WHICH MAY CAUSE LOSS OF HUMAN LIFE, BODILY INJURY, SERIOUS PROPERTY DAMAGE AND/OR SERIOUS PUBLIC IMPACT ("UNINTENDED USE").** Except for specific applications as expressly stated in this document, Unintended Use includes, without limitation, equipment used in nuclear facilities, equipment used in the aerospace industry, lifesaving and/or life supporting medical equipment, equipment used for automobiles, trains, ships and other transportation, traffic signaling equipment, equipment used to control combustions or explosions, safety devices, elevators and escalators, and devices related to power plant. **IF YOU USE PRODUCT FOR UNINTENDED USE, TOSHIBA ASSUMES NO LIABILITY FOR PRODUCT.** For details, please contact your TOSHIBA sales representative or contact us via our website.
- Do not disassemble, analyze, reverse-engineer, alter, modify, translate or copy Product, whether in whole or in part.
- Product shall not be used for or incorporated into any products or systems whose manufacture, use, or sale is prohibited under any applicable laws or regulations.
- The information contained herein is presented only as guidance for Product use. No responsibility is assumed by TOSHIBA for any infringement of patents or any other intellectual property rights of third parties that may result from the use of Product. No license to any intellectual property right is granted by this document, whether express or implied, by estoppel or otherwise.
- **ABSENT A WRITTEN SIGNED AGREEMENT, EXCEPT AS PROVIDED IN THE RELEVANT TERMS AND CONDITIONS OF SALE FOR PRODUCT, AND TO THE MAXIMUM EXTENT ALLOWABLE BY LAW, TOSHIBA (1) ASSUMES NO LIABILITY WHATSOEVER, INCLUDING WITHOUT LIMITATION, INDIRECT, CONSEQUENTIAL, SPECIAL, OR INCIDENTAL DAMAGES OR LOSS, INCLUDING WITHOUT LIMITATION, LOSS OF PROFITS, LOSS OF OPPORTUNITIES, BUSINESS INTERRUPTION AND LOSS OF DATA, AND (2) DISCLAIMS ANY AND ALL EXPRESS OR IMPLIED WARRANTIES AND CONDITIONS RELATED TO SALE, USE OF PRODUCT, OR INFORMATION, INCLUDING WARRANTIES OR CONDITIONS OF MERCHANTABILITY, FITNESS FOR A PARTICULAR PURPOSE, ACCURACY OF INFORMATION, OR NONINFRINGEMENT.**
- Do not use or otherwise make available Product or related software or technology for any military purposes, including without limitation, for the design, development, use, stockpiling or manufacturing of nuclear, chemical, or biological weapons or missile technology products (mass destruction weapons). Product and related software and technology may be controlled under the applicable export laws and regulations including, without limitation, the Japanese Foreign Exchange and Foreign Trade Law and the U.S. Export Administration Regulations. Export and re-export of Product or related software or technology are strictly prohibited except in compliance with all applicable export laws and regulations.
- Please contact your TOSHIBA sales representative for details as to environmental matters such as the RoHS compatibility of Product. Please use Product in compliance with all applicable laws and regulations that regulate the inclusion or use of controlled substances, including without limitation, the EU RoHS Directive. **TOSHIBA ASSUMES NO LIABILITY FOR DAMAGES OR LOSSES OCCURRING AS A RESULT OF NONCOMPLIANCE WITH APPLICABLE LAWS AND REGULATIONS.**

---

Toshiba Electronic Devices & Storage Corporation

<https://toshiba.semicon-storage.com/>

## X-ON Electronics

Largest Supplier of Electrical and Electronic Components

*Click to view similar products for [Power Switch ICs - Power Distribution](#) category:*

*Click to view products by [Toshiba](#) manufacturer:*

Other Similar products are found below :

[TLE6232GP](#) [NCP45520IMNTWG-L](#) [VND5E004ATR-E](#) [FPF1018](#) [DS1222](#) [NCV380HMUAJAATBG](#) [SZNCP3712ASNT3G](#)  
[NCP45520IMNTWG-H](#) [VND5004ATR-E](#) [AP22811BW5-7](#) [SLG5NT1437VTR](#) [SZNCP3712ASNT1G](#) [DML1008LDS-7](#) [TS13011-QFNR](#)  
[VND7012AYTR](#) [NCV459MNWTBG](#) [NCP4545IMNTWG-L](#) [NCV8412ASTT1G](#) [NCV8412ASTT3G](#) [FPF2260ATMX](#) [SLG5NT1765V](#)  
[SLG5NT1757V](#) [NCP45780IMN24RTWG](#) [AP2151DMPG-13](#) [AP2151AMP-13](#) [NCP45540IMNTWG-L](#) [TPS2022P](#) [FPF2495BUCX](#)  
[NCP45650IMNTWG](#) [NCV8412ADDR2G](#) [DK5V100R20S](#) [BTS7020-2EPA](#) [BTT6100-2ERA](#) [BTS71220-4ESA](#) [DK5V100R15M](#)  
[WS3220C9-9/TR](#) [BTT6030-2ERA](#) [TLE75602-ESH](#) [BTS5200-4EKA](#) [DK5V150R25M](#) [DK5V45R25](#) [DK5V100R25S](#) [AW35206FOR](#)  
[BTS7120-2EPA](#) [TLE75008-ESD](#) [BTS7040-1EPA](#) [BTT6030-1ERA](#) [DK5V60R10S](#) [DK5V45R25S](#) [DK5V60R10](#)