

# TOSHIBA

## Industrial Inverter (For 3-phase induction motors)

### Instruction Manual

# TOSVERT VF-S15

<Detailed manual>

3-phase 240V class	0.4 to 15kW
1-phase 240V class	0.2 to 2.2kW
3-phase 500V class	0.4 to 15kW

#### NOTICE

1. Make sure that this instruction manual is delivered to the end user of the inverter unit.
2. Read this manual before installing or operating the inverter unit, and store it in a safe place for reference.

E6581611

Safety  
precautions

**I**

Contents

Read first

**1**

Connection

**2**

Operations

**3**

Setting  
parameters

**4**

Main  
parameters

**5**

Other  
parameters

**6**

Operation  
with external  
signal

**7**

Monitoring the  
operation status

**8**

Measures  
to satisfy the  
standards

**9**

Peripheral  
devices

**10**

Table of  
parameters  
and data

**11**

Specifications

**12**

Before making  
a service call

**13**

Inspection and  
maintenance

**14**



Warranty

**15**

Disposal of the  
inverter

**16**



## Explanation of markings

Marking	Meaning of marking
 <b>Warning</b>	Indicates that errors in operation may lead to death or serious injury.
 <b>Caution</b>	Indicates that errors in operation may lead to injury (*1) to people or that these errors may cause damage to physical property. (*2)

(\*1) Such things as injury, burns or shock that will not require hospitalization or long periods of outpatient treatment.

(\*2) Physical property damage refers to wide-ranging damage to assets and materials.

## Meanings of symbols





Marking	Meaning of marking
	Indicates prohibition (Don't do it). What is prohibited will be described in or near the symbol in either text or picture form.
	Indicates an instruction that must be followed. Detailed instructions are described in illustrations and text in or near the symbol.
	-Indicates warning. What is warned will be described in or near the symbol in either text or picture form. -Indicates caution. What the caution should be applied to will be described in or near the symbol in either text or picture form.

control, traffic, safety device, amusement, or medical.



It may be considerable whether to apply, under the special condition or an application where strict quality control may not be required. Please contact your Toshiba distributor.



- ▼ Please use our product in applications where do not cause serious accidents or damages even if product is failure, or please use in environment where safety equipment is applicable or a backup circuit device is provided outside the system.
- ▼ Please do not use our product for any load other than three-phase induction motors in general industrial use. (Use in other than properly applied three-phase induction motors may cause an accident.)  
Single-phase input model is output by the inverter as three-phase output and cannot drive a single-phase motor.

## ■ Handling

 <b>Warning</b>		Reference section
 Disassembly prohibited	<ul style="list-style-type: none"><li>• Never disassemble, modify or repair. This can result in electric shock, fire and injury. Call your Toshiba distributor for repairs.</li></ul>	2.
 Prohibited	<ul style="list-style-type: none"><li>• Never remove the terminal block cover when power is on. The unit contains many high voltage parts and contact with them will result in electric shock.</li><li>• Do not stick your fingers into openings such as cable wiring holes and cooling fan covers. This can result in electric shock or other injury.</li><li>• Do not place or insert any kind of object (electrical wire cuttings, rods, wires etc.) into the inverter. This can result in electric shock or fire.</li><li>• Do not allow water or any other fluid to come in contact with the inverter. This can result in electric shock or fire.</li></ul>	2.1 2. 2. 2.
 Mandatory action	<ul style="list-style-type: none"><li>• Turn the power on only after attaching the terminal block cover. If the power is turned on without the terminal block cover attached, this can result in electric shock or other injury.</li><li>• If the inverter begins to emit smoke or an unusual odor, or unusual sounds, immediately turn the power off. Continuous use of the inverter in such a state may cause fire. Call your Toshiba distributor for repairs.</li><li>• Always turn the power off if the inverter is not used for long periods of time since there is a possibility of malfunction caused by leaks, dust and other material. If power is left on with the inverter in that state, it may result in fire.</li></ul>	2.1 3. 3.



## ■ Transportation & installation

 <b>Warning</b>		Reference section
 Prohibited	<ul style="list-style-type: none"> <li>• Do not install or operate the inverter if it is damaged or any component is missing. This can result in electric shock or fire. Call your Toshiba distributor for repairs.</li> <li>• Do not place any inflammable objects near the inverter.</li> </ul> <p>If an accident occurs in which flame is emitted, this could lead to fire.</p> <ul style="list-style-type: none"> <li>• Do not install in any location where the inverter could come into contact with water or other fluids.</li> </ul> <p>This can result in <b>electric shock or fire</b>.</p>	<p>1.4.4</p> <p>1.4.4</p> <p>1.4.4</p>
 Mandatory action	<ul style="list-style-type: none"> <li>• Operate under the environmental conditions prescribed in the instruction manual. Operations under any other conditions may result in malfunction.</li> <li>• Mount the inverter on a metal plate.</li> <li>• The rear panel gets very hot. Do not install in an inflammable object, this can result in fire.</li> <li>• Do not operate with the terminal block cover removed. This can result in electric shock. Failure to do so can lead to risk of electric shock and can result in death or serious injury.</li> <li>• An emergency stop device must be installed that fits with system specifications (e.g. shut off input power then engage mechanical brake). Operation cannot be stopped immediately by the inverter alone, thus resulting in an accident or injury.</li> <li>• All options used must be those specified by Toshiba. The use of any other option may result in an accident.</li> <li>• When using switchgear for the inverter, it must be installed in a cabinet. Failure to do so can lead to risk of electric shock.</li> </ul>	<p>1.4.4</p> <p>1.4.4</p> <p>1.4.4</p> <p>1.4.4</p> <p>1.4.4</p> <p>10</p>

 <b>Caution</b>		Reference section
 Prohibited	<ul style="list-style-type: none"> <li>• When transporting or carrying, do not hold by the front panel covers. The covers may come off and the unit will drop, resulting in injury.</li> <li>• Do not install in any area where the unit would be subject to large amounts of vibration. This could cause the unit to fall, resulting in bodily injury.</li> </ul>	<p>2.</p> <p>1.4.4</p>



- If braking is necessary (to hold motor shaft), install a mechanical brake.
- The brake on the inverter will not function as a mechanical hold, and if used for that purpose, injury may result.



## ■ Wiring

 <b>Warning</b>		Reference section
 Prohibited	<ul style="list-style-type: none"> <li>• Do not connect input power to the output (motor side) terminals (U/T1, V/T2, W/T3). Connecting input power to the output could destroy the inverter or cause a fire.</li> <li>• Do not insert a braking resistor between DC terminals (between PA/+ and PC/- or PO and PC/-). It could cause a fire.</li> <li>• First shut off input power and wait at least 15 minutes before touching terminals and wires on equipment (MCCB) that is connected to inverter power side. Touching the terminals and wires before that time could result in electric shock.</li> <li>• Do not shut down the external power supply on ahead when VIA terminal is used as logic input terminal by external power supply. It could cause unexpected result as VIA terminal is ON status.</li> </ul>	2.2 2.2 2.2 2.2
 Mandatory action	<ul style="list-style-type: none"> <li>• Electrical construction work must be done by a qualified expert. Connection of input power by someone who does not have that expert knowledge may result in fire or electric shock.</li> <li>• Connect output terminals (motor side) correctly. If the phase sequence is incorrect, the motor will operate in reverse and that may result in injury.</li> <li>• Wiring must be done after installation. If wiring is done prior to installation, that may result in injury or electric shock.</li> <li>• The following steps must be performed before wiring.               <ol style="list-style-type: none"> <li>(1) Turn off all input power.</li> <li>(2) Wait at least 15 minutes and check to make sure that the charge lamp is no longer lit.</li> <li>(3) Use a tester that can measure DC voltage (400VDC or 800VDC or more), and check to make sure that the voltage to the DC main circuits (across PA/+ - PC/-) is 45V or less. If these steps are not properly performed, the wiring will cause electric shock.</li> </ol> </li> <li>• Tighten the screws on the terminal block to specified torque. If the screws are not tightened to the specified torque, it may lead to fire.</li> <li>• Check to make sure that the input power voltage is +10%, -15% of the rated power voltage (±10% when the load is 100% in continuous operation) written on the name plate. If the input power voltage is not +10%, -15% of the rated power voltage (±10% when the load is 100% in continuous operation), this may result in fire.</li> <li>• Set a parameter <math>F 109</math> when VIA or VIB terminals are used as logic input terminal. If it is not set, it could result in malfunction.</li> <li>• Set a parameter <math>F 147</math> when S3 terminal is used as PTC input terminal. If it is not set, it could result in malfunction.</li> </ul>	2.1 2.1 2.1 2.1 2.1 1.4.4 2.2 2.2

 Prohibited	the output (motor side) terminals. This could cause a fire.	
--	--	--



## ■ Operations

 <b>Warning</b>		Reference section
 Prohibited	<ul style="list-style-type: none"> <li>Never touch the internal connector while the upper terminal cover of control panel is opened. There is a risk of electrical shock because it carries a high voltage.</li> <li>Do not touch inverter terminals when electrical power is going to the inverter even if the motor is stopped. Touching the inverter terminals while power is connected to it may result in electric shock.</li> <li>Do not touch switches when the hands are wet and do not try to clean the inverter with a damp cloth. Such practices may result in electric shock.</li> <li>Do not go near the motor in alarm-stop status when the retry function is selected. The motor may suddenly restart and that could result in injury. Take measures for safety, e.g. attaching a cover to the motor, against accidents when the motor unexpectedly restarts.</li> </ul>	1.3.2  3.  3.  3.
 Mandatory action	<ul style="list-style-type: none"> <li>Turn the input power on only after attaching the terminal block cover. When enclosed inside a cabinet and used with the terminal block cover removed, always close the cabinet doors first and then turn the power on. If the power is turned on with the terminal block cover or cabinet doors open may result in electric shock.</li> <li>Make sure that operation signals are off before resetting the inverter after malfunction. If the inverter is reset before turning off the operating signal, the motor may restart suddenly, resulting in injury.</li> <li>If incorrect setting, the drive may have some damage or unexpected movement. Be sure to set the setup menu correctly.</li> </ul>	3.  3.  3.1



 <b>Caution</b>		Reference section
 Prohibited	<ul style="list-style-type: none"> <li>Observe all permissible operating ranges of motors and mechanical equipment. (Refer to the motor's instruction manual.) Not observing these ranges may result in injury.</li> <li>Do not set the stall prevention level (<math>F_{\text{B}} \text{ } i</math>) extremely low. If the stall prevention level parameter (<math>F_{\text{B}} \text{ } i</math>) is set at or below the no-load current of the motor, the stall preventive function will be always active and increase the frequency when it judges that regenerative braking is taking place. Do not set the stall prevention level parameter (<math>F_{\text{B}} \text{ } i</math>) below 30% under normal use conditions.</li> </ul>	3.  6.29.2

occur even the motor no-load current.  
 Make enough space among each phase cable or install the filter (MSF) as countermeasure.



■ When operation by using remote keypad is selected

 Warning		Reference section
 Mandatory action	<ul style="list-style-type: none"> <li>Set the parameter Communication time-out time (<i>F B Q 3</i>), Communication time-out action (<i>F B Q 4</i>) and Disconnection detection of extension panel (<i>F 7 3 i</i>). If these are not properly set, the inverter can not be stopped immediately in breaking communication and this could result in injury and accidents.</li> </ul>	6.38.1
	<ul style="list-style-type: none"> <li>An emergency stop device and the interlock that fit with system specifications must be installed. If these are not properly installed, the inverter can not be stopped immediately and this could result in injury and accidents.</li> </ul>	6.38.1

■ When sequence for restart after a momentary failure is selected (inverter)



 Caution		Reference section
 Mandatory action	<ul style="list-style-type: none"> <li>Stand clear of motors and mechanical equipment. If the motor stops due to a momentary power failure, the equipment will start suddenly after power is restored. This could result in unexpected injury.</li> </ul>	5.9
	<ul style="list-style-type: none"> <li>Attach caution label about sudden restart after a momentary power failure on inverters, motors and equipment for prevention of accidents in advance.</li> </ul>	5.9

■ When retry function is selected (inverter)

 Caution		Reference section
 Mandatory action	<ul style="list-style-type: none"> <li>Stand clear of motors and equipment. If the motor and equipment stop when the alarm is given, selection of the retry function will restart them suddenly after the specified time has elapsed. This could result in unexpected injury.</li> </ul>	6.19.3
	<ul style="list-style-type: none"> <li>Attach caution label about sudden restart in retry function on inverters, motors and equipment for prevention of accidents in advance.</li> </ul>	6.19.3

 Mandatory action	discovered and that could result in accidents.	14. 14.2
	<ul style="list-style-type: none"> <li>Before inspection, perform the following steps. <ol style="list-style-type: none"> <li>Turn off all input power to the inverter.</li> <li>Wait at least 15 minutes and check to make sure that the charge lamp is no longer lit.</li> <li>Use a tester that can measure DC voltages (400V/800V DC or more), and check that the voltage to the DC main circuits (across PA/+ - PC/-) is 45V or less.</li> </ol> </li> </ul> Performing an inspection without carrying out these steps first could lead to electric shock.	

## ■ Disposal

 <b>Caution</b>		Reference section
 Mandatory action	<ul style="list-style-type: none"> <li>If you dispose of the inverter, have it done by a specialist in industry waste disposal (*). If you dispose of the inverter by yourself, this can result in explosion of capacitor or produce noxious gases, resulting in injury.</li> </ul>	16.
	(*) Persons who specialize in the processing of waste and known as "industrial waste product collectors and transporters" or "industrial waste disposal persons". Please observe any applicable law, regulation, rule or ordinance for industrial waste disposal.	

## ■ Attach caution labels

Shown here are examples of caution labels to prevent, in advance, accidents in relation to inverters, motors and other equipment. Be sure to affix the caution label where it is easily visible when selecting the auto-restart function (5.9) or the retry function (6.19.3).

If the inverter has been programmed for restart sequence of momentary power failure, place warning labels in a place where they can be easily seen and read. (Example of caution label)
 <b>Caution (Functions programmed for restart)</b>
Do not go near motors and equipment. Motors and equipment that have stopped temporarily after momentary power failure will restart suddenly after recovery.

If the retry function has been selected, place warning labels in a location where they can be easily seen and read. (Example of caution label)
 <b>Caution (Functions programmed for retry)</b>
Do not go near motors and equipment. Motors and equipment that have stopped temporarily after an alarm will restart suddenly after the specified time has elapsed.



1.4	Notes on the application .....	A-21
2.	Connection .....	B-1
2.1	Cautions on wiring .....	B-1
2.2	Standard connections .....	B-3
2.3	Description of terminals .....	B-6
3.	Operations .....	C-1
3.1	How to Set the Setup Menu .....	C-2
3.2	Simplified Operation of the VF-S15 .....	C-4
3.3	How to operate the VF- S15 .....	C-9
4.	Setting parameters .....	D-1
4.1	Setting and Display Modes .....	D-1
4.2	How to set parameters .....	D-3
4.3	Functions useful in searching for a parameter or changing a parameter setting .....	D-7
4.4	Checking the region settings selection .....	D-13
4.5	EASY key function .....	D-14
5.	Main parameters .....	E-1
5.1	Meter setting and adjustment .....	E-1
5.2	Setting acceleration/deceleration time .....	E-4
5.3	Maximum frequency .....	E-5
5.4	Upper limit and lower limit frequencies .....	E-6
5.5	Base frequency .....	E-7
5.6	Setting the electronic thermal .....	E-8
5.7	Preset-speed operation (speeds in 15 steps) .....	E-16
5.8	Switching between two frequency commands .....	E-19
5.9	Auto-restart (Restart of coasting motor) .....	E-21
5.10	Changing operation panel display .....	E-23
6.	Other parameters .....	F-1
6.1	Parameters useful for setting and adjustments .....	F-2
6.2	Selection of operation mode .....	F-12
6.3	Selecting control mode .....	F-17

6.13	Stop at lower-limit frequency operation (sleep function).....	F-48
6.14	Jog run mode .....	F-49
6.15	Jump frequency - avoiding resonant frequencies.....	F-51
6.16	Bumpless operation .....	F-52
6.17	Low voltage operation .....	F-54
6.18	PWM carrier frequency .....	F-54
6.19	Trip-less intensification.....	F-60
6.20	Drooping control.....	F-73
6.21	Light-load high-speed operation function .....	F-75
6.22	Braking function .....	F-75
6.23	Acceleration/deceleration suspend function (Dwell function) .....	F-76
6.24	PID control .....	F-78
6.25	Setting motor constants.....	F-85
6.26	Torque limit.....	F-91
6.27	Acceleration/deceleration time 2 and 3 .....	F-96
6.28	Shock monitoring function.....	F-100
6.29	Protection functions.....	F-101
6.30	Forced fire-speed control function.....	F-115
6.31	Override .....	F-116
6.32	Analog input terminal function selection.....	F-119
6.33	Adjustment parameters .....	F-120
6.34	Operation panel parameter .....	F-124
6.35	Tracing functions.....	F-134
6.36	Integrating wattmeter .....	F-134
6.37	Parameter registration to easy setting mode.....	F-134
6.38	Communication function.....	F-135
6.39	Permanent magnet motors.....	F-143
6.40	Traverse function.....	F-144
7.	Operations with external signal .....	G-1
7.1	Operating external signals .....	G-1
7.2	Applied operations by an I/O signal (operation from the terminal block) .....	G-2
7.3	Speed instruction (analog signal) settings from external devices .....	G-12

10. Peripheral devices .....	J-1
10.1 Selection of wiring materials and devices .....	J-1
10.2 Installation of a magnetic contactor .....	J-4
10.3 Installation of an overload relay .....	J-5
10.4 Optional external devices .....	J-6
11. Table of parameters and data .....	K-1
11.1 Frequency setting parameter .....	K-1
11.2 Basic parameters .....	K-1
11.3 Extended parameters .....	K-5
11.4 Default settings by inverter rating .....	K-28
11.5 Default settings by setup menu .....	K-29
11.6 Input Terminal Function .....	K-30
11.7 Output Terminal Function .....	K-34
11.8 Application easy setting .....	K-38
11.9 Unchangeable parameters in running .....	K-39
12. Specifications .....	L-1
12.1 Models and their standard specifications .....	L-1
12.2 Outside dimensions and mass .....	L-4
13. Before making a service call - Trip information and remedies .....	M-1
13.1 Trip causes/warnings and remedies .....	M-1
13.2 Restoring the inverter from a trip .....	M-7
13.3 If the motor does not run while no trip message is displayed .....	M-8
13.4 How to determine the causes of other problems .....	M-9
14. Inspection and maintenance .....	N-1
14.1 Regular inspection .....	N-1
14.2 Periodical inspection .....	N-2
14.3 Making a call for servicing .....	N-5
14.4 Keeping the inverter in storage .....	N-5

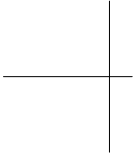

iv

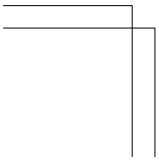



**Mandatory action**

Use an inverter that conforms to the specifications of power supply and three-phase induction motor being used. If the inverter being used does not conform to those specifications, not only will the three-phase induction motor not rotate correctly, but it may also cause serious accidents through overheating and fire.

**Rating label**

**Inverter main unit**

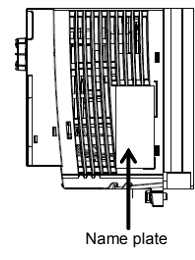

Model  
Power supply  
Motor capacity



**Carton box**

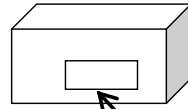

Type indication label

**Setup sheet**

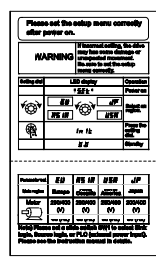

**Danger label**



**Name plate**

**TOSHIBA**  
TRANSISTOR INVERTER  
**VFS15S-2002PL-W**  
0.2kW-0.6kVA-0.25HP [0]

	INPUT	OUTPUT
GV	1PH 200...240	3PH 200...240
F(Hz)	50/60	0.1...500
I(A)	3.4	1.5

SCCR : For rating and protection refer to User Manual

Serial No. 8118 18021202 0001 (1)  
Made in Indonesia  
Motor Overload Protection Class 10

**TOSHIBA INDUSTRIAL PRODUCTS SALES CO. TSUJ**

CD-ROM

Contains the instruction manual in digital form



• Ensure proper earth connection.

**WARNING**  
 Gefahr von Verletzungen, Abstürzen, Stößen oder Brand.  
 Lesen Sie die Bedienungsanleitung.  
 • Vor dem Öffnen des Gehäuses die Stromversorgung unterbrechen.  
 • Die Stromversorgung wieder einschalten, wenn Sie die Stromversorgung wieder einschalten.  
 • Vor dem Öffnen des Gehäuses die Stromversorgung unterbrechen.

**⚠ DANGER**  
 Risk of injury, electric shock or fire.  
 Read the instruction manual. • Ensure proper earth connection.  
 Do not open the cover while power is applied.  
 Do not restart after power has been removed.

**AVVERTENZA**  
 Pericolo di lesioni, scosse elettriche o incendio.  
 Leggere attentamente il manuale d'uso.  
 • Prima di aprire il coperchio interrompere l'alimentazione.  
 • Quando si riacende l'alimentazione, assicurarsi che il coperchio sia chiuso e che l'alimentazione sia stata ripristinata.

**⚠ DANGER**  
 Risk of injury, electric shock or fire.  
 Read the instruction manual. • Ensure proper earth connection.  
 Do not open the cover while power is applied.  
 Do not restart after power has been removed.

**AVERTISSEMENT**  
 Risque de blessures, de électrocution ou d'incendie.  
 Lire attentivement le manuel d'utilisation.  
 Avant d'ouvrir le couvercle, interrompre l'alimentation.  
 Avant de rétablir l'alimentation, s'assurer que le couvercle est fermé et que l'alimentation a été rétablie.

**⚠ DANGER**  
 Risk of injury, electric shock or fire.  
 Read the instruction manual. • Ensure proper earth connection.  
 Do not open the cover while power is applied.  
 Do not restart after power has been removed.

- Germany / English
- Italian / English
- Spanish / English
- Chinese / English
- France / English

## 1.2 Contents of the product

Explanation of the name plate label

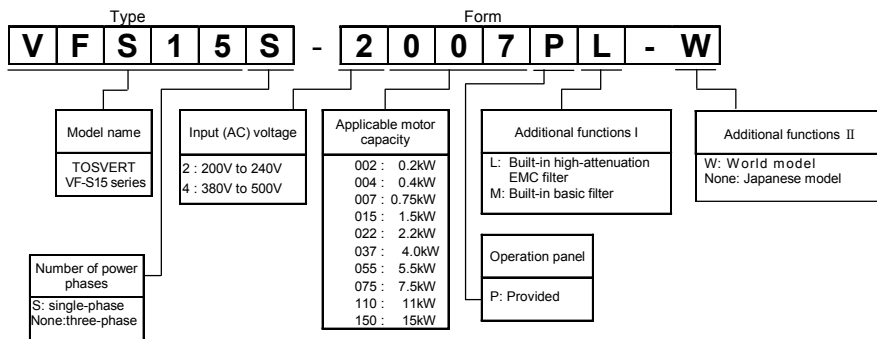

Note 1) Always shut power off first then check the ratings label of inverter held in a cabinet.

Note 2) ID label is stuck for special specification product.

Lights and blinks when using CANopen® communication option.

is lit because it is dangerous.



[Front view]

### Cover

This is the body and terminal block cover. Always close this cover before operation to avoid accidentally touching the terminal block. The serial number is recorded on the back side.

### Door lock

Slide the door lock to upside for unlock.

Hole for control circuit wiring

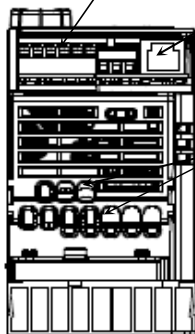

[Bottom view]

Protective label (Note 1)

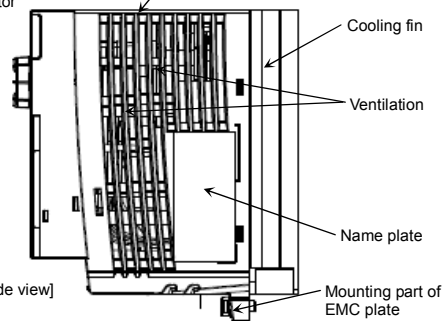

[Side view]

Note 1) Remove the protective label as shown on the next page when installing the inverter side by side with other inverters and using the inverter in locations with temperatures above 40°C.

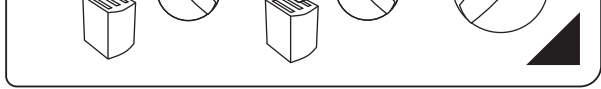

[Opening the cover]

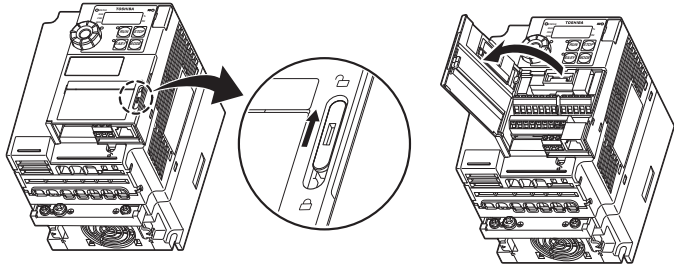

Insert a small screw driver  
and slide the door lock to  
upside for unlock.  
(Slide it to downside for lock.)

★About the monitor display

The LED on the operation panel uses the following symbols to indicate parameters and operations.

LED display (numbers)

0	1	2	3	4	5	6	7	8	9	-
0	1	2	3	4	5	6	7	8	9	-

LED display (letters)

Aa	Bb	C	c	Dd	Ee	Ff	Gg	H	h	I	i	Jj	Kk	Ll
A	b	C	c	d	E	F	G	H	h	i	i	J	K	L
Mm	Nn	O	o	Pp	Qq	Rr	Ss	Tt	Uu	Vv	Ww	Xx	Yy	Zz
m	n	O	o	P	q	r	S	t	u	v	w	x	y	z



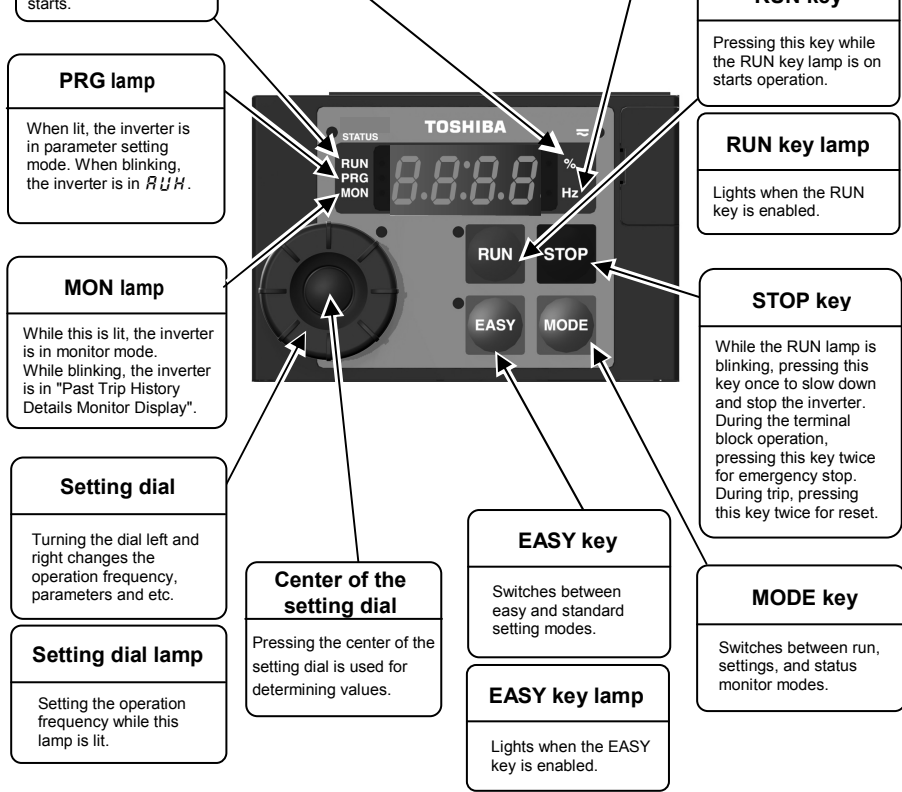



 **Caution**

 <b>Mandatory action</b>	<ul style="list-style-type: none"> <li>When removing and mounting the terminal cover or the terminal block with a screwdriver, be sure not to scratch your hand as these results in injury.</li> <li>Pressing too hard on the screwdriver may scratch the inverter.</li> <li>Always turn the power off when removing the wiring cover.</li> <li><b>After wiring is complete, be sure to replace the terminal cover.</b></li> </ul>
--	--

Use the following procedure to open the terminal cover and pull the power terminal block.

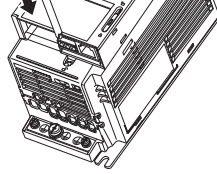
Inverter type	Procedure	Reference number
VFS15-2004PM-W to 2007PM-W VFS15S-2002PL-W to 2007PL-W	In the beginning, remove the outside terminal block cover.	(1)
	Next, remove the inside terminal block cover.	(2)
VFS15-2015PM-W to 2037PM-W VFS15S-2015PL-W, 2022PL-W VFS15-4004PL-W to 4015PL-W	In the beginning, remove the outside terminal block cover.	(3)
	Next, remove the inside terminal block cover.	(4)
VFS15-4022PL-W, 4037PL-W	In the beginning, remove the outside terminal block cover.	(3)
	Next, remove the inside terminal block cover.	(5)
VFS15-2055PM-W to 2150PM-W VFS15-4055PL-W to 4150PL-W	Follow a procedure and remove the power terminal cover.	(6)



Insert a screwdriver or other thin object into the hole indicated with the  mark.

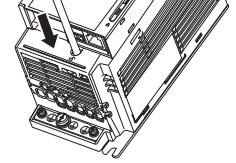

Press in on the screwdriver.

3)

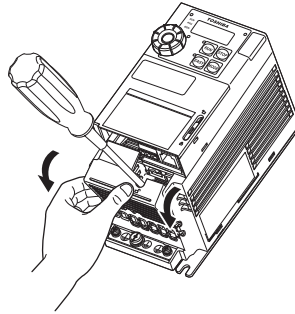

While pressing on the screwdriver, rotate the terminal cover downward to remove it.

4)

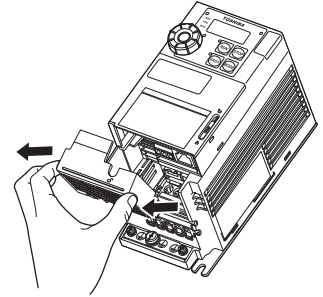

Pull the terminal cover up at an angle.

★ After wiring is complete, be sure to restore the terminal cover to its original position.

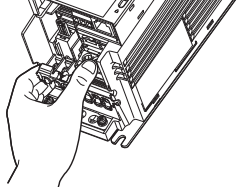

The finger is put on to the tab part of the terminal block cover.

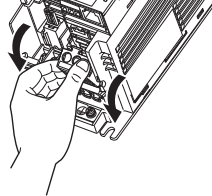

While pressing on the screwdriver, rotate the terminal cover downward to remove it.

3)

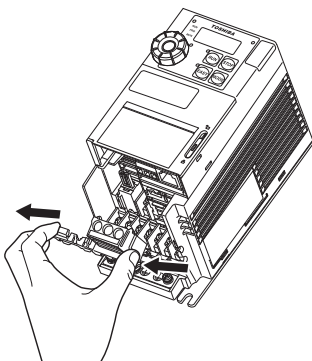

Pull the terminal cover up at an angle.

★ After wiring is complete, be sure to restore the terminal cover to its original position.

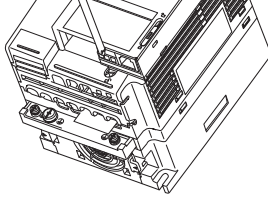

Insert a screwdriver or other thin object into the hole indicated with the  mark.

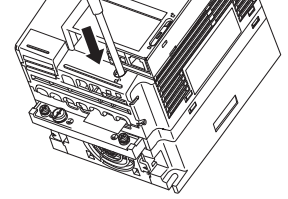

Press in on the screwdriver.

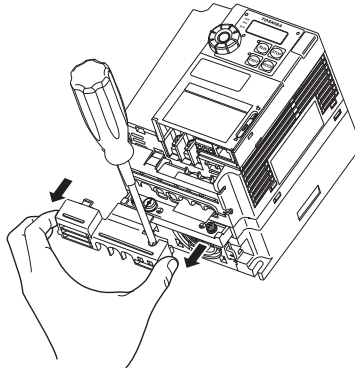
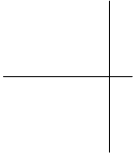

3)

While pressing on the screwdriver, slides the terminal cover downward to remove it.

★ After wiring is complete, be sure to restore the terminal cover to its original position.

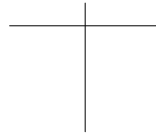
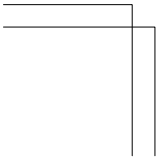

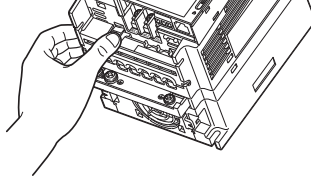

The finger is put on to the tab part of the terminal block cover.

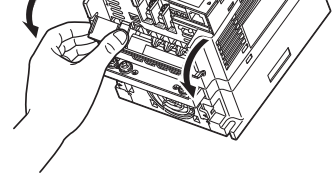

While pressing on the screwdriver, rotate the terminal cover downward to remove it.

3)

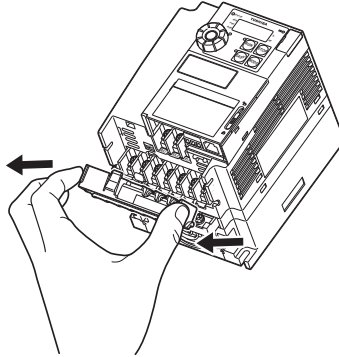

Pull the terminal cover up at an angle.

★ After wiring is complete, be sure to restore the terminal cover to its original position.

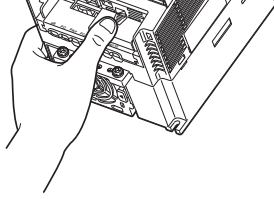

The finger is put on to the tab part of the terminal block cover.

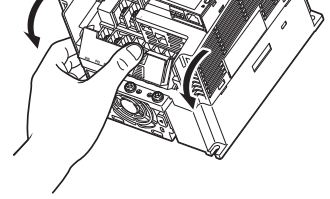

While pressing on the screwdriver, rotate the terminal cover downward to remove it.

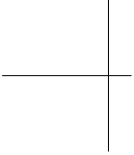

3)

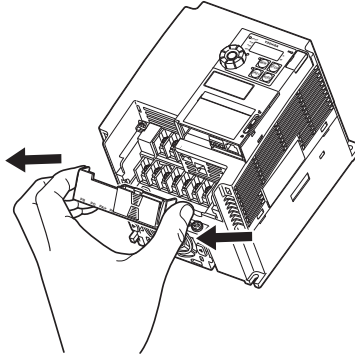

Pull the terminal cover up at an angle.

★ After wiring is complete, be sure to restore the terminal cover to its original position.

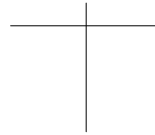
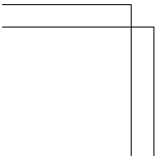

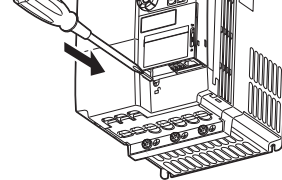

Insert a screwdriver or other thin object into the hole indicated with the  mark.

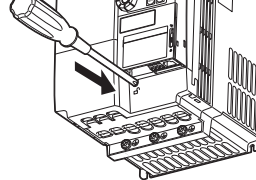

Press in on the screwdriver.

3)

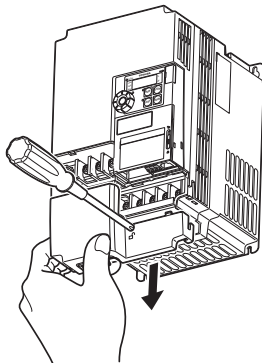

While pressing on the screwdriver, slide the terminal cover downward to remove it.

★ After wiring is complete, be sure to restore the terminal cover to its original position.



M3.5 screw	1.0 N·m	8.9 lb·in
M4 screw	1.4 N·m	12.4 lb·in
M6 screw	4.5 N·m	40.0 lb·in
M4 screw (grounding terminal)	1.4 N·m	12.4 lb·in
M5 screw (grounding terminal)	2.8 N·m	24.8 lb·in

Refer to section 2.3.1 for details about terminal functions.

VFS15-2004PM-W to 2007PM-W

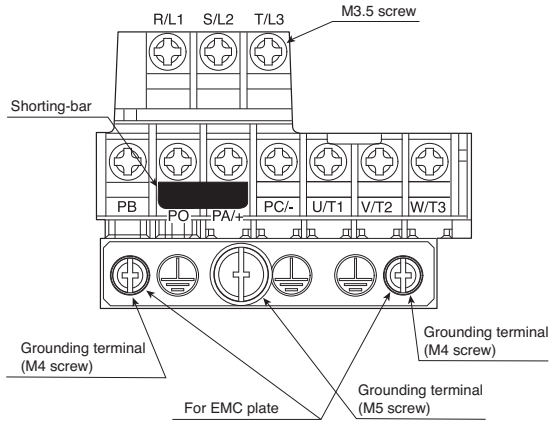

Note1) Bend the clips on the wiring port of the terminal cover to connect the PB, PO, PA+, and PC- terminals.

Note2) Be careful to insert all wires into the cage of terminal block.

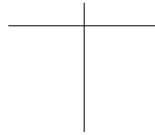
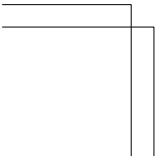

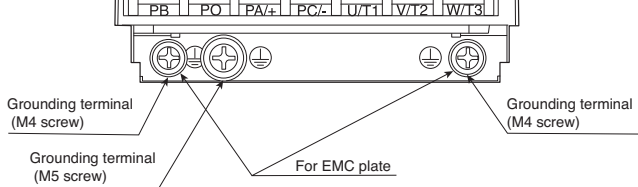

VFS15-2037PM-W

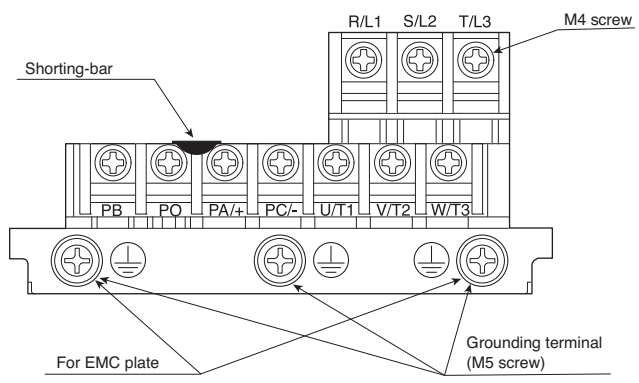

- Note1) Bend the clips on the wiring port of the terminal cover to connect the PB, PO, PA/+, and PC/- terminals.  
 Note2) Be careful to insert all wires into the cage of terminal block.

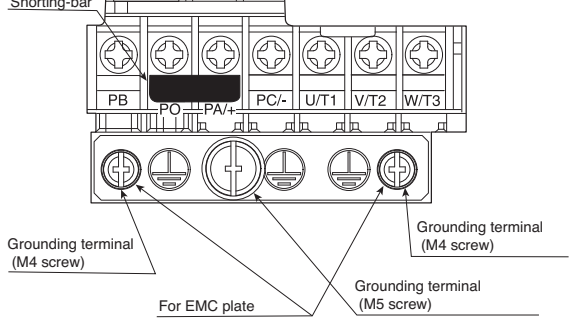

VFS15S-2015PL-W, 2022PL-W

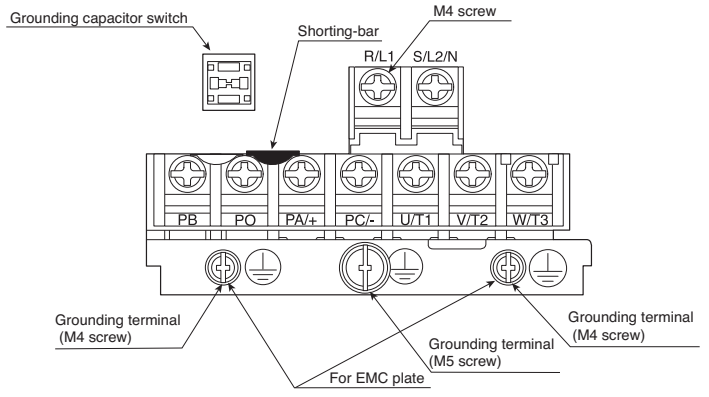

Note1) Bend the clips on the wiring port of the terminal cover to connect the PB, PO, PA/+, and PC/- terminals.  
 Note2) Be careful to insert all wires into the cage of terminal block.

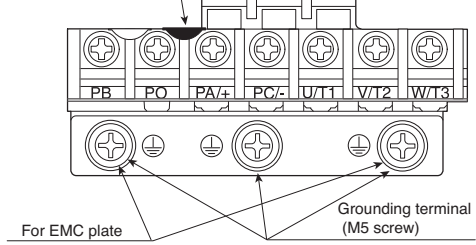

VFS15-4022PL-W, 4037PL-W

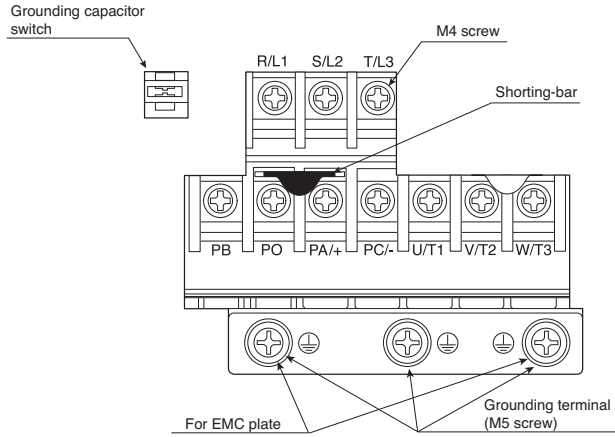

Note1) Bend the clips on the wiring port of the terminal cover to connect the PB, PO, PA+, and PC- terminals.  
 Note2) Be careful to insert all wires into the cage of terminal block.

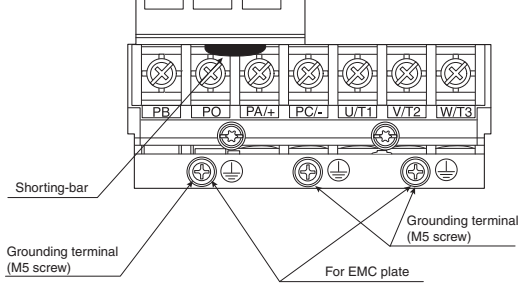

VFS15-2110PM-W, 2150PM-W

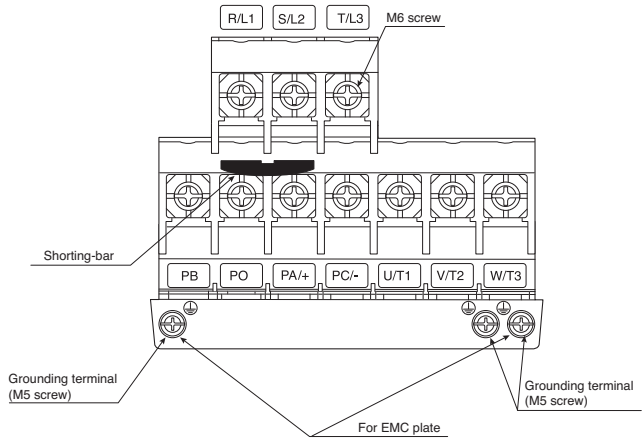

Note1) Bend the clips on the wiring port of the terminal cover to connect the PB, PO, PA/+, and PC/- terminals.  
 Note2) Be careful to insert all wires into the cage of terminal block.

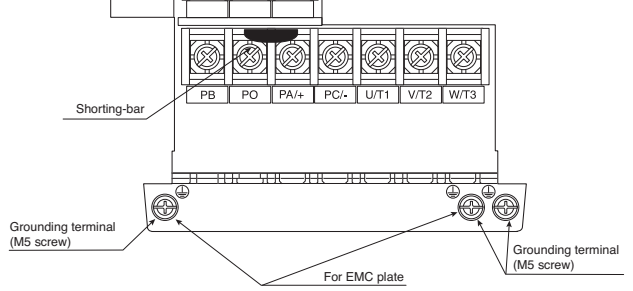

- Note1) Bend the clips on the wiring port of the terminal cover to connect the PB, PO, PA/+, and PC/- terminals.  
 Note2) Be careful to insert all wires into the cage of terminal block.

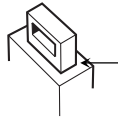

Pressing this switches the grounding capacitor's capacity from small to large. (Default setting)

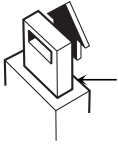

Pulling this switches the grounding capacitor's capacity from large to small. This reduces the leakage current.  
When this inverter is connected to the IT system (insulated ground of power supply or the system has Impedance), the switch has to be pulled as the figure shows.

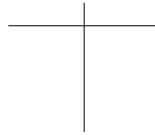
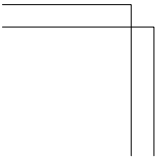
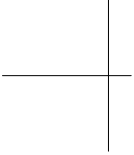

CC NO OUTP24 F R CC +SU +24



⊕ Screw for removable control terminal block



RS485 connector

Screw size	Recommended tightening torque
M3 screw	0.5 N·m
	4.4 lb·in

Stripping length: 6 (mm)  
Screwdriver: Small-sized flat-blade screwdriver  
(Blade thickness: 0.5 mm, blade width: 3.5 mm)

Refer to section 2.3.2 for details about all terminal functions.

Wire size

Conductor	1 wire	2 wires of same size
Solid	0.3-1.5mm <sup>2</sup> (AWG 22-16)	0.3-0.75mm <sup>2</sup> (AWG 22-18)
Stranded		

Recommended ferrule

Using ferrule to be improved efficiency and reliability of wiring is recommended.

Wire size mm <sup>2</sup> (AWG)	Type	
	PHOENIX CONTACT	Dinkle International.,Ltd
0.34 (22)	Al 0.34-6TQ	DN00306
0.5 (20)	Al 0.5-6WH	DN00506
0.75 (18)	Al 0.75-6GY	DN00706
1 (18)	Al 1-6RD	DN01006
1.5 (16)	Al 1.5-8BK	DN01508
*2 2 X 0.5 (-)	Al TWIN2 X 0.5-8WH	DTE00508
*2 2 X 0.75 (-)	Al TWIN2 X 0.75-8GY	DTE00708

\*1: Crimping pliers CRIMPFOX ZA3 (PHOENIX CONTACT)  
CT1 (Dinkle International.,Ltd)

\*2: These ferrules enable practical crimping of two wires in a ferrule.





being operated. If the inverter being used does not conform to those specifications, not only will the three-phase induction motor not rotate correctly, but it may cause serious accidents through overheating and fire.

### Comparisons with commercial power operation

This inverter employs the sinusoidal PWM system. However, the output voltage and output current are not perfect sine waves, they have a distorted wave that is close to sinusoidal waveform. This is why compared to operation with a commercial power there will be a slight increase in motor temperature, noise and vibration.

### Operation in the low-speed area

When running continuously at low speed in conjunction with a general purpose motor, there may be a decline in that motor's cooling effect. If this happens, operate with the output decreased from rated load. To carry out low-speed operation continuously at the rated torque, we recommend to use a inverter rated motor or a forced cooled motor designed for use with an inverter. When operating in conjunction with an inverter rated motor, you must change the inverter's motor overload protection level  $\overline{U}L\overline{r}$  to VF motor use.

### Adjusting the overload protection level

This inverter protects against overloads with its overload detection circuits (electronic thermal). The electronic thermal's reference current is set to the inverter's rated current, so it must be adjusted in line with the rated current of the motor being used in combination.

### High speed operation at and above 60Hz

Operating at frequencies greater than 60Hz will increase noise and vibration. There is also a possibility this will exceed the motor's mechanical strength limits and the bearing limits so you should inquire to the motor's manufacturer about such operation.

### Method of lubricating load mechanisms

Operating an oil-lubricated reduction gear and gear motor in the low-speed areas will worsen the lubricating effect. Check with the manufacturer of the reduction gear to find out about operable gearing area.

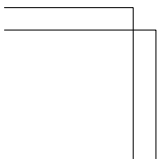
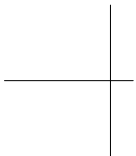

Combine with a much smaller motor according to the applicable motor rating of the inverter.

- Combined with special motors

To deal with the above lower the settings of inverter carrier frequency.

- Combined with couplings between load devices and motors with high backlash

When using the inverter in the above combination, use the S-pattern acceleration/deceleration function, or when vector control is selected, adjust the load inertia moment ratio or switch to V/f control mode.

- Combined with loads that have sharp fluctuations in rotation such as piston movements

In this case, adjust the load inertia moment ratio during vector control or switch to V/f control.

### Braking a motor when cutting off power supply

A motor with its power cut off goes into free-run, and does not stop immediately. To stop the motor quickly as soon as the power is cut off install an auxiliary brake. There are different kinds of brake devices, both electrical and mechanical. Select the brake that is best for the system.

### Load that produces regenerative torque

When combined with a load that produces regenerative torque, the overvoltage or overcurrent protection function may be activated to trip the inverter.

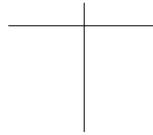
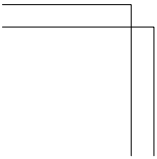
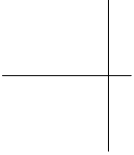

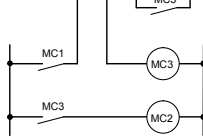

Circuit diagram 1

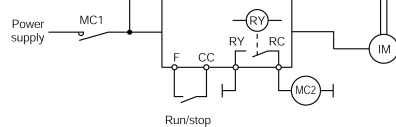

In circuit diagram 1, the brake is turned on and off through MC2 and MC3. If you do not wire it as shown in diagram 1, an over-current trip may occur because of a bound current during brake operation. (Example of standby ST assigned to terminal S2.)

In circuit diagram 2, the brake is turned on and off by using low-speed signal RY-RC.

In some situations, such as with elevators, turning the brake on and off with a low-speed signal may be appropriate. Be sure to contact us before designing your system.

### Measures to protect motors against surge voltages

In a system in which a 500V-class inverter is used to control the operation of a motor, very high surge voltages may be produced. When applied to the motor coils repeatedly for a long time, may cause deterioration of their insulation, depending on the cable length, cable routing and types of cables used. Here are some examples of measures against surge voltages.

- (1) Lower the inverter's carrier frequency.
- (2) Set the parameter  $F \bar{3} \bar{1} \bar{5}$  (Carrier frequency control mode selection) to  $\bar{2}$  or  $\bar{3}$ .
- (3) Use a motor with high insulation strength.
- (4) Insert an AC reactor or a surge voltage suppression filter between the inverter and the motor.

### Inverter Capacity

Do not use a small-capacity (kVA) inverter to control the operation of a large-capacity motor (two-class or more larger motor), no matter how light the load is. Current ripple will raise the output peak current making it easier to set off the overcurrent trip.

### Power factor correction capacitor

Power factor correction capacitors cannot be installed on the output side of the inverter. When a motor is run that has a power factor correction capacitor attached to it, remove the capacitors. This can cause inverter malfunction and capacitor destruction.

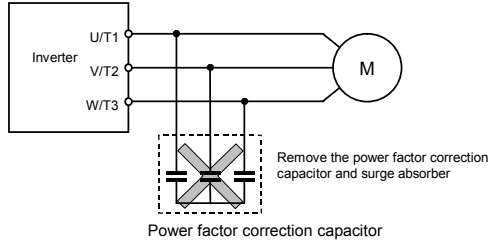
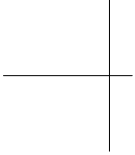

### Operating at other than rated voltage

Connections to voltages other than the rated voltage described in the rating label cannot be made. If a connection must be made to a power supply other than one with rated voltage, use a transformer to raise or lower the voltage to the rated voltage.

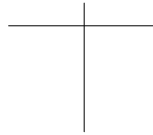
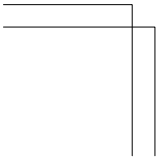



Breaking of selected inverter

There is no fuse in the inverter's main circuit. Thus, as the diagram above shows, when more than one inverter is used on the same power line, you must select interrupting characteristics so that only MCCB2 to MCCBn+1 will trip and the MCCB1 will not trip when a short occurs in the inverter (INV1). When you cannot select the proper characteristics install a circuit interrupting fuse behind MCCB2 to MCCBn+1.

### If power supply distortion is not negligible

If the power supply distortion is not negligible because the inverter shares a power distribution line with other systems causing distorted waves, such as systems with thyristors or large-capacity inverters, install an input AC reactor to improve the input power factor, to reduce higher harmonics, or to suppress external surges.

### If multiple inverters are connected with common DC bus link

When inverters are fed by AC power supply and connected with common DC bus link, ground fault trip protection may operate. In that case, set ground fault detection selection (*F 5 1 4*) to  "Disabled".

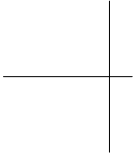

## ■ Disposal

Refer to chapter 16.

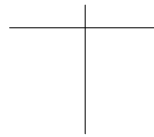
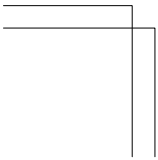

### (1) Influence of leakage current across ground

Leakage current may flow not just through the inverter system but also through ground wires to other systems. Leakage current will cause earth leakage breakers, leakage current relays, ground relays, fire alarms and sensors to operate improperly, and it will cause superimposed noise on the TV screen or display of incorrect current detection with the CT.

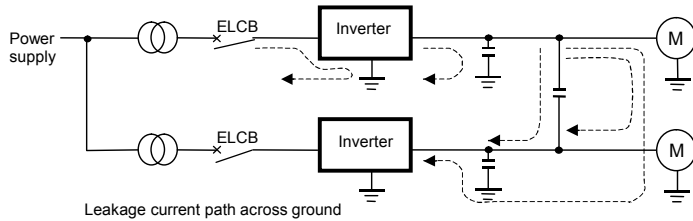

#### Remedies:

1. If there is no radio-frequency interference or similar problem, detach the built-in noise filter capacitor, using the grounding capacitor switch.
2. Reduce PWM carrier frequency.  
The setting of PWM carrier frequency is done with the parameter  $F300$ .  
Although the electromagnetic noise level is reduced, the motor acoustic noise is increased.
3. Use high frequency remedial products for earth leakage breakers

## (1) Thermal relays

The high frequency component of current leaking into electrostatic capacity between inverter output wires will increase the effective current values and make externally connected thermal relays operate improperly. If the wires are more than 50 meters long, it will be easy for the external thermal relay to operate improperly with models having motors of low rated current (several A(ampere) or less), because the leakage current will increase in proportion to the motor rating.

## Remedies:

1. Use the electronic thermal built into the inverter. (Refer to section 5.6)  
The setting of the electronic thermal is done using parameter  $U L P, L H r$ .
2. Reduce the inverter's PWM carrier frequency. However, that will increase the motor's magnetic noise.  
The setting of PWM carrier frequency is done with the parameter  $F \exists Q Q$ . (Refer to section 6.18)
3. This can be improved by installing  $0.1\mu$  to  $0.5\mu F$  - 1000V film capacitor to the input/output terminals of each phase in the thermal relay.

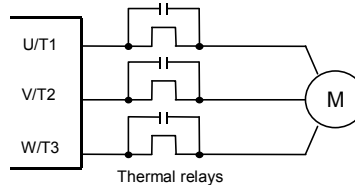



## (2) CT and ammeter



If a CT and ammeter are connected externally to detect inverter output current, the leak current's high frequency component may destroy the ammeter. If the wires are more than 50 meters long, it will be easy for the high frequency component to pass through the externally connected CT and be superimposed on and burn the ammeter with models having motors of low rated current (several A (ampere) or less), especially the 500V class low capacity (4.0kW or less) models, because the leakage current will increase in proportion to the motor's rated current.

## 1.4.4 Installation

### ■ Installation environment

This inverter is an electronic control instrument. Take full consideration to installing it in the proper operating environment.

 <b>Warning</b>	
 Prohibited	<ul style="list-style-type: none"> <li>Do not place any inflammable substances near the inverter. If an accident occurs in which flame is emitted, this could lead to fire.</li> <li>Do not install in any location where the inverter could come into contact with water or other fluids. This can result in electric shock or fire.</li> </ul>
 Mandatory action	<ul style="list-style-type: none"> <li>Operate under the environmental conditions prescribed in the instruction manual. Operations under any other conditions may result in malfunction.</li> <li>Check to make sure that the input power voltage is +10%, -15% of the rated power voltage (<math>\pm 10\%</math> when the load is 100% in continuous operation) written on the name plate. If the input power voltage is not +10%, -15% of the rated power voltage (<math>\pm 10\%</math> when the load is 100% in continuous operation), this may result in fire.</li> </ul>

 <b>Caution</b>	
 Prohibited	<ul style="list-style-type: none"> <li>Do not install the inverter in any location subject to large amounts of vibration. This could cause the unit to fall, resulting in bodily injury.</li> </ul>



When using the inverter in locations with temperatures above 40°C, remove the protective label on the top of the inverter and use the inverter with the output current reduced according to section 6.18.



[Position for measuring ambient temperature]

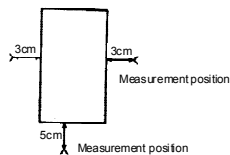

Note: The inverter is a heat-emitting body. Make sure proper space and ventilation is provided when installing in the cabinet.

- Do not install in any location that is subject to large amounts of vibration.



Note: If the inverter is installed in a location that is subject to vibration, anti-vibration measures are required. Please consult with Toshiba about these measures.

- If the inverter is installed near any of the equipment listed below, provide measures to insure against errors in operation.

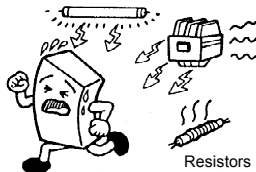

- |                      |                                   |
|----------------------|-----------------------------------|
| Solenoids:           | Attach surge suppressor on coil.  |
| Brakes:              | Attach surge suppressor on coil.  |
| Magnetic contactors: | Attach surge suppressor on coil.  |
| Fluorescent lights:  | Attach surge suppressor on coil.  |
| Resistors:           | Place far away from the inverter. |



Mandatory action

- Do not operate with the terminal block cover removed. This can result in electric shock.
- An emergency stop device must be installed that fits with system specifications (e.g. shut off input power then engage mechanical brake). Operation cannot be stopped immediately by the inverter alone, thus, resulting in an accident or injury.
- All options used must be those specified by Toshiba. The use of any other option may result in an accident.

## ⚠ Caution



Mandatory action

- The main unit must be installed on a base that can bear the unit's weight. If the unit is installed on a base that cannot withstand that weight, the unit may fall, resulting in injury.
- If braking is necessary (to hold motor shaft), install a mechanical brake. The brake on the inverter will not function as a mechanical hold, and if used for that purpose, injury may result.

### (1) Normal installation

Select an indoor location with good ventilation, and then install it upright on a flat metal plate.

When installing multiple inverters, leave at least 3 cm of space between each inverter and install them aligned horizontally.

When using the inverter in locations with temperatures above 40°C, remove the protective label on the top of the inverter and use the inverter with the output current reduced according to section 6.18.

### (2) Side-by-side installation

To align the inverters side-by-side horizontally, remove the protective label on the top of the inverter before use. When using the inverter in locations with temperatures above 40°C, use the inverter with the output current reduced.

If the door is opened 90° or more, please open the door with the left side inverter's door open when the same capacity inverters are installed with side-by-side.

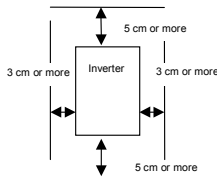

Normal installation

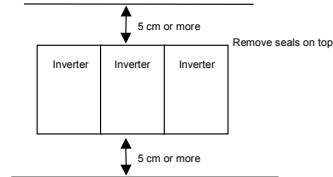

Side-by-side installation

Calorific values of the inverter and the required ventilation  
 About 5% of the rated power of the inverter will be lost as a result of conversion from AC to DC or from DC to AC. In order to suppress the rise in temperature inside the cabinet when this loss becomes heat loss, the interior of the cabinet must be ventilated and cooled.

The amount of forcible air-cooling ventilation required and the necessary heat discharge surface quantity when operating in a sealed cabinet according to motor capacity are as follows.

Voltage class	Inverter type	Calorific values (W) Note 1)		Amount of forcible air cooling ventilation required (m <sup>3</sup> /min)		Heat discharge surface area required for sealed storage cabinet (m <sup>2</sup> )		Standby power requirement (W) Note 2)	
		4kHz	12kHz	4kHz	12kHz	4kHz	12kHz		
Three-phase 240V class	VFS15-	2004PM-W	35	40	0.20	0.23	0.70	0.80	6
		2007PM-W	45.6	50	0.26	0.28	0.91	0.99	6
		2015PM-W	81	92	0.46	0.52	1.61	1.85	10
		2022PM-W	94.9	104	0.54	0.59	1.90	2.07	10
		2037PM-W	139	154	0.79	0.87	2.77	3.08	11
		2055PM-W	256	283	1.45	1.61	5.12	5.66	22
		2075PM-W	305	367	1.73	2.08	6.10	7.34	22
		2110PM-W	475	538	2.70	3.05	9.50	10.76	31
2150PM-W	557	628	3.16	3.56	11.14	12.56	31		
Single-phase 240V class	VFS15S-	2002PL-W	23	24.8	0.13	0.14	0.46	0.50	5
		2004PL-W	37	42.2	0.21	0.24	0.74	0.84	5
		2007PL-W	46	50	0.26	0.28	0.92	1.00	5
		2015PL-W	79	90	0.45	0.51	1.57	1.80	8
		2022PL-W	101	110	0.58	0.62	2.03	2.20	8
Three-phase 500V class	VFS15-	4004PL-W	30	39	0.17	0.22	0.61	0.78	12
		4007PL-W	39	50	0.22	0.28	0.78	1.00	12
		4015PL-W	58	76	0.33	0.43	1.15	1.53	12
		4022PL-W	77	102	0.44	0.58	1.53	2.04	13
		4037PL-W	131	156	0.75	0.88	2.63	3.12	13
		4055PL-W	211	263	1.20	1.49	4.22	5.26	22
		4075PL-W	254	346	1.44	1.96	5.08	6.92	22
		4110PL-W	387	470	2.20	2.67	7.74	9.40	31
4150PL-W	466	572	2.65	3.25	9.32	11.44	31		

Note 1) Case of 100% Load Continuation operation. The heat loss for the optional external devices (input AC reactor, radio noise reduction filters, etc.) is not included in the calorific values in the table

Note 2) It is power consumption when power is on but is not output (0Hz), and cooling fan is activated (model with cooling fan).

- Ground the inverter grounding terminals ( $\perp$ ).
- Install surge suppressor on any magnetic contactor and relay coils used around the inverter.
- Install noise filters if necessary.
- To comply with the EMC directives, install the optional EMC plate and fix the shield to it.
- Install EMC plate and use shielded wires.

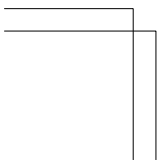
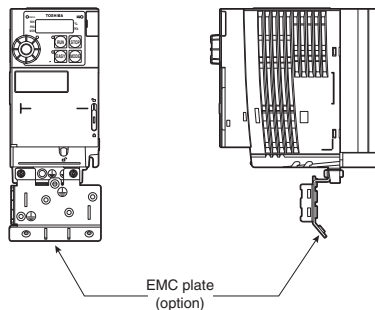
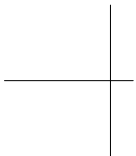

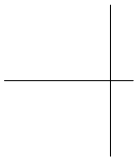
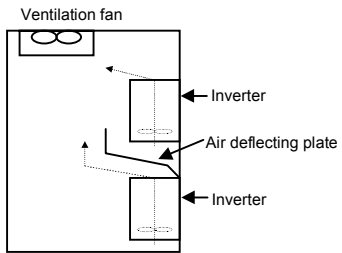

- Install an air deflecting plate so that the heat rising up from the inverter on the bottom does not affect the inverter on the top.



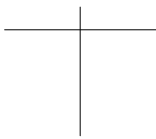
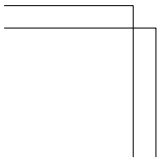

A-33



prohibited  Prohibited	<ul style="list-style-type: none"> <li>Do not stick your fingers into openings such as cable wiring holes and cooling fan covers. This can result in electric shock or other injury.</li> <li>Do not place or insert any kind of object (electrical wire cuttings, rods, wires) into the inverter. This can result in electric shock or fire.</li> <li>Do not allow water or any other fluid to come in contact with the inverter. That may result in electric shock or fire.</li> </ul>
---	--

 <b>Caution</b>	
Prohibited 	<ul style="list-style-type: none"> <li>When transporting or carrying, do not hold by the front panel covers. The covers may come off and the unit will drop, resulting in injury.</li> </ul>

## 2.1 Cautions on wiring

 <b>Warning</b>	
Prohibited 	<ul style="list-style-type: none"> <li>Never remove the terminal cover when power is on. The unit contains many high voltage parts and contact with them will result in electric shock.</li> </ul>
Mandatory action 	<ul style="list-style-type: none"> <li>Turn the power on only after attaching the terminal block cover. If the power is turned on without the terminal block cover attached, this can result in electric shock or other injury.</li> <li>Electrical construction work must be done by a qualified expert. Connection of input power by someone who does not have that expert knowledge may result in fire or electric shock.</li> <li>Connect output terminals (motor side) correctly. If the phase sequence is incorrect, the motor will operate in reverse and that may result in injury.</li> <li>Wiring must be done after installation. If wiring is done prior to installation, that may result in injury or electric shock.</li> <li>The following steps must be performed before wiring.             <ol style="list-style-type: none"> <li>Shut off all input power.</li> <li>Wait at least 15 minutes and check to make sure that the charge lamp is no longer lit.</li> <li>Use a tester that can measure DC voltage (400VDC or 800VDC or more), and check to make sure that the voltage to the DC main circuits (across PA/+ - PC/-) is 45V or less. If these steps are not properly performed, the wiring will cause electric shock.</li> </ol> </li> <li>Tighten the screws on the terminal block to specified torque. If the screws are not tightened to the specified torque, it may lead to fire.</li> </ul>

### ■ Preventing radio noise

To prevent electrical interference such as radio noise, separately bundle wires to the main circuit's power terminals (3-phase models: R/L1, S/L2, T/L3, single-phase models: R/L1, S/L2/N) and wires to the motor terminals (U/T1, V/T2, W/T3).

### ■ Control and main power supply



The control power supply and the main circuit power supply for this inverter are the same.

If a malfunction or trip causes the main circuit to be shut off, control power will also be shut off. When checking the cause of the malfunction or the trip, use the trip holding retention selection parameter.

In addition, please use an optional control power supply backup unit when only control power supply operates, even if the main circuit is shut off due to trouble or tripping.

### ■ Wiring

- Because the space between the main circuit terminals is small, use sleeved crimp-style terminals for the connections. Connect the terminals so that adjacent terminals do not touch each other.
- For grounding terminal (Ⓧ) use wires of the size that is equivalent to or larger than those given in table 10.1 and always ground the inverter (240V voltage class: D type ground, 500V voltage class: C type ground).  
Use as large and short a grounding wire as possible and wire it as close as possible to the inverter.
- For the sizes of electric wires used in the main circuit, refer to the table in section 10.1.
- The length of each wire does not exceed 30 meters. If the wire is longer than 30 meters, the wire size (diameter) must be increased.

Prohibited	<p>equipment (MCCB) that is connected to inverter power side. Touching the terminals and wires before that time could result in electric shock.</p> <ul style="list-style-type: none"> <li>Do not shut down the external power supply on ahead when VIA terminal is used as logic input terminal by external power supply. It could cause unexpected result as VIA terminal is ON status.</li> </ul>
 Mandatory action	<ul style="list-style-type: none"> <li>Set a parameter <math>F 109</math> when VIA or VIB terminals are used as logic input terminal. If it is not set, it could result in malfunction.</li> <li>Set a parameter <math>F 147</math> when S3 terminal is used as PTC input terminal. If it is not set, it could result in malfunction.</li> </ul>
 Be Grounded	<ul style="list-style-type: none"> <li>Ground must be connected securely. If the ground is not securely connected, it could lead to electric shock or fire.</li> </ul>

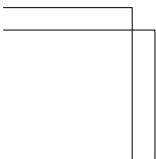
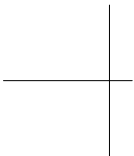



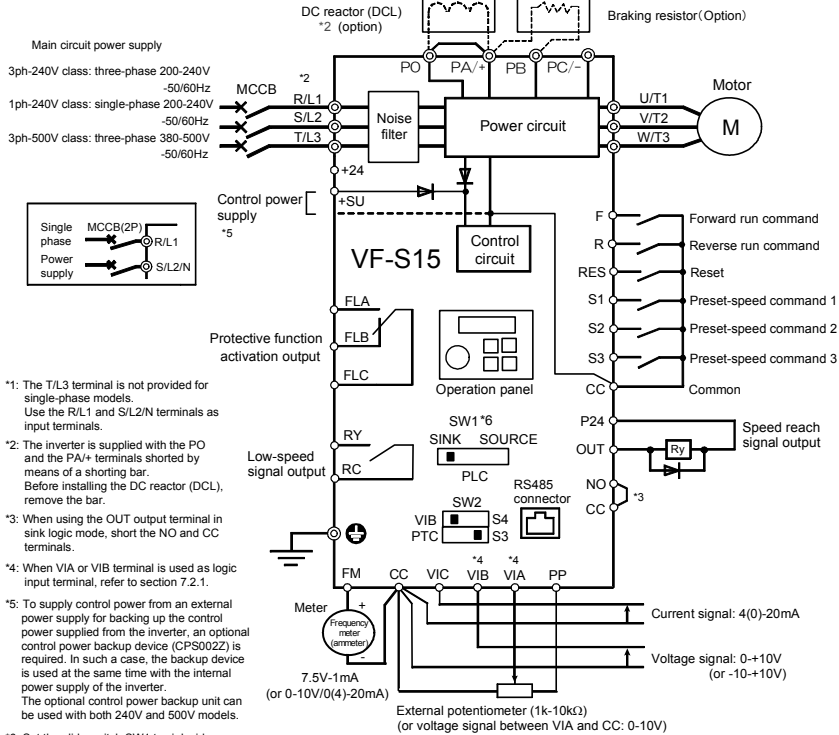

- \*1: The T/L3 terminal is not provided for single-phase models. Use the R/L1 and S/L2/N terminals as input terminals.
- \*2: The inverter is supplied with the PO and the PA/+ terminals shorted by means of a shorting bar. Before installing the DC reactor (DCL), remove the bar.
- \*3: When using the OUT output terminal in sink logic mode, short the NO and CC terminals.
- \*4: When VIA or VIB terminal is used as logic input terminal, refer to section 7.2.1.
- \*5: To supply control power from an external power supply for backing up the control power supplied from the inverter, an optional control power backup device (CPS002Z) is required. In such a case, the backup device is used at the same time with the internal power supply of the inverter. The optional control power backup unit can be used with both 240V and 500V models.
- \*6: Set the slide switch SW1 to sink side. Refer to page B-11.12 for details. Default setting is PLC side.

Main circuit power supply  
 3ph-240V class: three-phase 200-240V  
 -50/60Hz  
 1ph-240V class: single-phase 200-240V  
 -50/60Hz  
 3ph-500V class: three-phase 380-500V  
 -50/60Hz

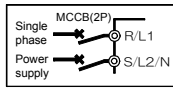

- \*1: The T/L3 terminal is not provided for single-phase models. Use the R/L1 and S/L2/N terminals as input terminals.
- \*2: The inverter is supplied with the PO and the PA/+ terminals shorted by means of a shorting bar. Before installing the DC reactor (DCL), remove the bar.
- \*3: When using the NO output terminal in source logic mode, short the P24 and OUT terminals.
- \*4: When VIA or VIB terminal is used as logic input terminal, refer to section 7.2.1.
- \*5: To supply control power from an external power supply for backing up the control power supplied from the inverter, an optional control power backup device (CPS002Z) is required. In such a case, the backup device is used at the same time with the internal power supply of the inverter. The optional control power backup unit can be used with both 240V and 500V models.
- \*6: Set the slide switch SW1 to source side. Refer to page B-11,12 for details. Default setting is PLC side.

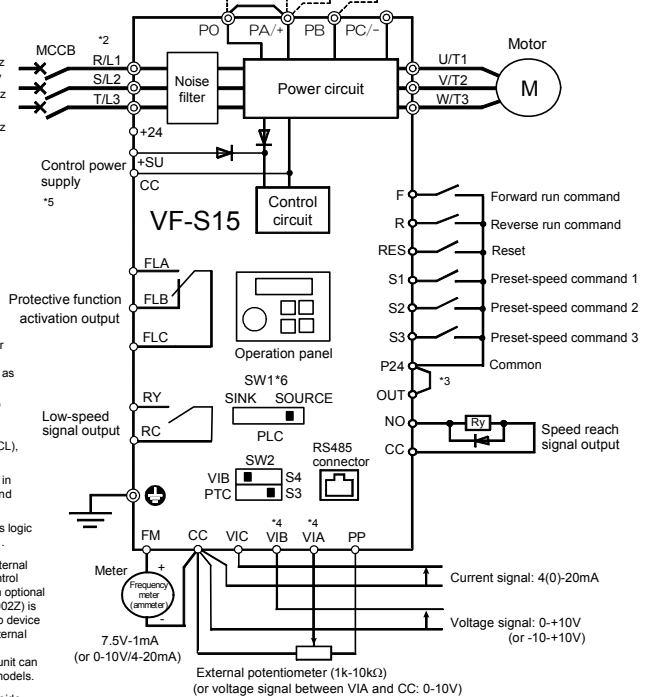

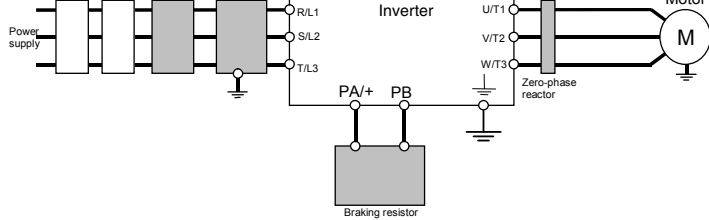

Note 1: The T/L3 terminal is not provided for any single-phase models. So if you are using single-phase models, use the R/L1 and S/L2/N terminals to connect power cables.

■ Power circuit

Terminal symbol	Terminal function
	Grounding terminal for connecting inverter. There are 3 terminals in cooling fin or mounting part of EMC plate.
R/L1,S/L2,T/L3	240V class : Three-phase 200 to 240V-50/60Hz : Single-phase 200 to 240V-50/60Hz 500V class : Three-phase 380 to 500V-50/60Hz * Single-phase inputs are R/L1 and S/L2/N terminals.
U/T1,V/T2,W/T3	Connect to three-phase motor.
PA+, PB	Connect to braking resistors. Change parameters <i>F304, F305, F308, F309</i> if necessary.
PA/+	This is a positive potential terminal in the internal DC main circuit. DC common power can be input with PC/- terminal.
PC/-	This is a negative potential terminal in the internal DC main circuit. DC common power can be input with PA/+ terminal.
PO, PA/+	Terminals for connecting a DC reactor (DCL: optional external device). Shorted by a short bar when shipped from the factory. Before installing DCL, remove the short bar.

The arrangements of power circuit terminals are different from each range.

Refer to section 1.3.3.1) for details.

Symbol	Output	Specifications
F	Input	Shorting across F-CC or P24-F causes forward rotation; open causes deceleration stop. (When Standby ST is always ON) 3 different functions can be assigned.
R	Input	Shorting across R-CC or P24-R causes reverse rotation; open causes deceleration stop. (When Standby ST is always ON) 3 different functions can be assigned.
RES	Input	This inverter protective function is reset if RES-CC or P24-RES is connected. Shorting RES-CC or P24-RES has no effect when the inverter is in a normal condition. 2 different functions can be assigned.
S1	Input	Shorting across S1-CC or P24-S1 causes preset speed operation. 2 different functions can be assigned.
S2	Input	Shorting across S2-CC or P24-S2 causes preset speed operation. By changing parameter $F 145$ setting, this terminal can also be used as a pulse train input terminal.
S3	Input	Shorting across S3-CC or P24-S3 causes preset speed operation. By changing slide switch SW2 and parameter $F 147$ setting, this terminal can also be used as a PTC input terminal.

Multifunction programmable logic input

No voltage logic input  
24Vdc-5mA or less

Sink/Source and PLC selectable using slide switch SW1  
(Default setting is PLC side)

Pulse train input (S2 terminal)  
Pulse frequency range:  
10pps~2kpps

PTC input (S3 terminal)

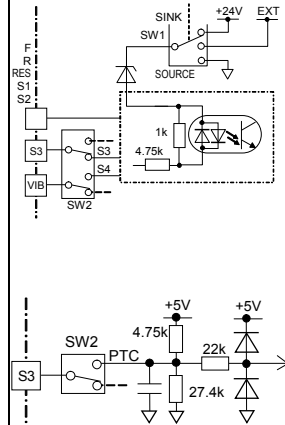

PP	Output	Analog power supply output	10Vdc (permissible load current: 10mA)	
VIA Note 1)	Input	<p>Multifunction programmable analog input. Default setting: 0-10Vdc (1/1000 resolution) and 0-60Hz (0-50Hz) frequency input (1/2000 resolution).</p> <p>By changing parameter <math>F_{I09}</math>, this terminal can also be used as a multifunction programmable logic input terminal.</p>	10Vdc (internal impedance: 30k $\Omega$ )	
VIB Note 1)	Input	<p>Multifunction programmable analog input. Default setting: 0-10Vdc (1/1000 resolution) and 0-60Hz (0-50Hz) frequency input.</p> <p>The function can be changed to -10-+10V input by parameter <math>F_{I07} = 1</math> setting.</p> <p>By switching slide switch SW2 and changing parameter <math>F_{I09}</math> setting, this terminal can also be used as a multifunction programmable logic input terminal.</p>	10Vdc (internal impedance: 30k $\Omega$ )	
VIC	Input	Multifunction programmable analog input. 4-20mA (0-20mA) input.	4-20mA (internal impedance: 250 $\Omega$ )	

		setting. Resolution Max. 1/1000.	0-10V DC volt meter Permissible load resistance: 1k $\Omega$ or more	
P24	Output	24Vdc power output	24Vdc-100mA Note 2)	
	Input	This terminal can be used as a common terminal when an external power supply is used by changing SW1 to PLC side.	-	
+24	Output	24Vdc power output	24Vdc-100mA Note 2)	
+SU	Input	DC power input terminal for operating the control circuit. Connect a control power backup device (option or 24Vdc power supply) between +SU and CC.	Voltage: 24Vdc $\pm$ 10% Current: 1A or more	

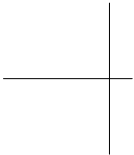

B-9

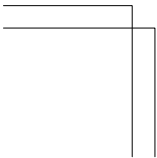

		By changing parameter $F559$ settings, these terminals can also be used as multifunction programmable pulse train output terminals.	Pulse frequency range: 10~2kpps	
FLA FLB FLC  Note 3)	Output	Multifunction programmable relay contact output. Detects the operation of the inverter's protection function. (Default setting) Contact across FLA-FLC is closed and FLB-FLC is opened during protection function operation.	Max. switching capacity 250Vac-2A 30Vdc-2A ( $\cos\phi=1$ ) : at resistive load  250Vac-1A ( $\cos\phi=0.4$ ) 30Vdc-1A ( $L/R=7ms$ )  Min. permissible load 5Vdc-100mA 24Vdc-5mA	
RY RC  Note 3)	Output	Multifunction programmable relay contact output. Default settings detect and output low-speed signal output frequencies. Multifunction output terminals to which two different functions can be assigned.	Max. switching capacity 250Vac-2A ( $\cos\phi=1$ ) : at resistive load  30Vdc-1A 250Vac-1A ( $\cos\phi=0.4$ )  Min. permissible load 5Vdc-100mA 24Vdc-5mA	

Note 1) When VIA terminal is used as logic input terminal, be sure to connect a resistor between P24 and VIA in case of sink logic, between VIA and CC in case of source logic. (Recommended resistance: 4.7k $\Omega$ -1/2W)  
It is not needed for VIB terminal.

Note 2) 100mA is the sum of P24 and +24.

Note 3) A chattering (momentary ON/OFF of contact) is generated by external factors of the vibration and the impact, etc. In particular, please set the filter of 10ms or more, or timer for measures when connecting it directly with input unit terminal of programmable controller. Please use the OUT terminal as much as possible when the programmable controller is connected.

supply, and its connections vary depending on the power supply used.  
Sink/source logic can be switched by slide switch SW1.

<Examples of connections when the inverter's internal power supply is used>

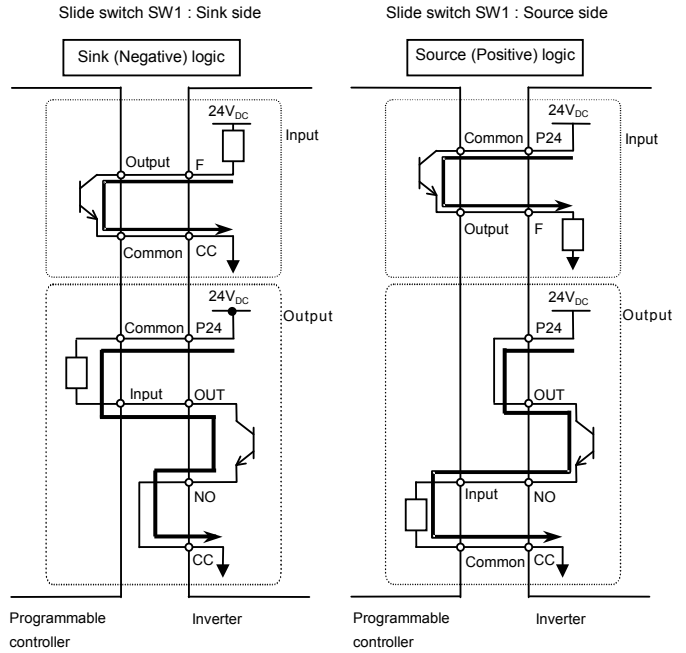



2

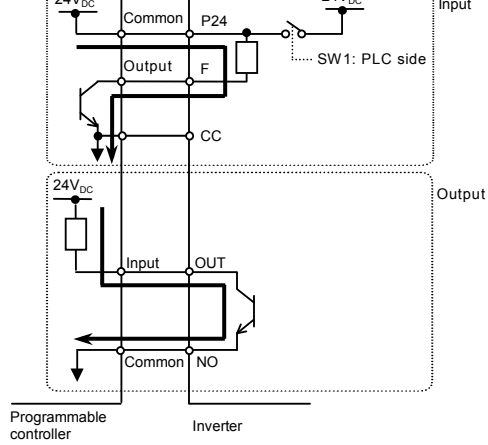
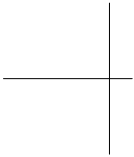

Note) Do not shut down the external power supply on ahead when VIA terminal is used as logic input terminal by external power supply.  
It could cause unexpected result as VIA terminal is ON status.

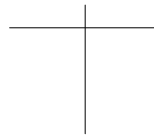
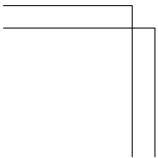

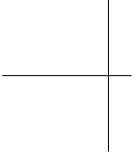

- (2) Switching of VIB terminal function: Upper SW2 (Default setting: VIB side)  
 Setting of analog input/ logic input for VIB terminal is switched by upper slide switch SW2 and parameter  $F 109$ .  
 When using VIB terminal as an analog input terminal, set the slide switch to VIB side and set the parameter  $F 109=0$ .  
 When using VIB terminal as a logic input terminal, set the slide switch to S4 side and set the parameter any value to  $F 109=1, 3, \text{ or } 4$ . Sink/ source logic depends on the slide switch SW1.  
 Match the setting of upper slide switch SW2 and parameter  $F 109$  surely.  
 If it is not, this can result in malfunction.



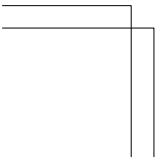

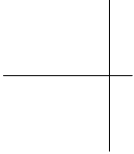
- (3) Switching of S3 terminal function: Lower SW2 (Default setting: S3 side)  
 Setting of logic input/ PTC input for S3 terminal is switched by lower slide switch SW2 and parameter  $F 147$ .  
 When using S3 terminal as a logic input terminal, set the slide switch to S3 side and set the parameter  $F 147=0$ .  
 When using S3 terminal as a PTC input terminal, set the slide switch to PTC side and set the parameter  $F 147=1$ .  
 Match the setting of lower slide switch SW2 and parameter  $F 147$  surely.  
 If it is not, this can result in malfunction.





Prohibited	<ul style="list-style-type: none"><li>Do not go near the motor in alarm-stop status when the retry function is selected. The motor may suddenly restart and that could result in injury. Take measures for safety, e.g. attaching a cover to the motor, against accidents when the motor unexpectedly restarts.</li></ul>
 Mandatory action	<ul style="list-style-type: none"><li>If the inverter begins to emit smoke or an unusual odor, or unusual sounds, immediately turn the power off. Continuous use of the inverter in such a state may cause fire. Call your Toshiba distributor for repairs.</li><li>Always turn the power off if the inverter is not used for long periods of time since there is a possibility of malfunction caused by leaks, dust and other material. If power is left on with the inverter in that state, it may result in fire.</li><li>Turn the input power on only after attaching the terminal block cover. When enclosed inside a cabinet and used with the terminal block cover removed, always close the cabinet doors first and then turn the power on. If the power is turned on with the terminal block cover or the cabinet doors open, this may result in electric shock.</li><li>Make sure that operation signals are off before resetting the inverter after malfunction. If the inverter is reset before turning off the operating signal, the motor may restart suddenly, resulting in injury.</li></ul>

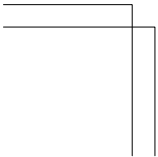

 <b>Caution</b>	
 Contact prohibited	<ul style="list-style-type: none"><li>Do not touch heat radiating fins or discharge resistors. These devices are hot, and you'll get burned if you touch them.</li></ul>
 Prohibited	<ul style="list-style-type: none"><li>Observe all permissible operating ranges of motors and mechanical equipment. (Refer to the motor's instruction manual.) Not observing these ranges may result in injury.</li></ul>



Set the setup menu according to the base frequency and the base frequency voltage of the motor connected. (If you are not sure which region code of setup menu should be selected and what values should be specified, consult your Toshiba distributor.)

Each setup menu automatically sets all parameters relating to the base frequency and the base frequency voltage of the motor connected. (See the table on the following page.)

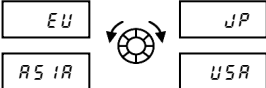
Follow these steps to change the setup menu [Example: Selecting a region code to *EU*]

Panel operated	LED display	Operation
	<i>SEt</i>	<i>SEt</i> is blinking
		Turn the setting dial, and select region code " <i>EU</i> " (Europe).
	<i>EU ⇄ In It</i>	Press the center of the setting dial to determine the region.
	<i>0.0</i>	The operation frequency is displayed (Standby).

☆ If you want to change the selected region by the setup menu, the setup menu will appear by the following settings.

Please note, however, that all setting parameters return to status of default setting.

- Set parameter *SEt* to "*0*".
- Set parameter *SEt* to "*13*".

☆ The parameter settings in the table on the following page can be changed individually even after they are selected in the setup menu.

<i>F 3 6 7</i> / <i>F 8 1 4</i>						
<i>U L U /</i> <i>F 1 7 1</i>	Base frequency voltage 1, 2	240V class	230(V)	230(V)	230(V)	200(V)
		500V class	400(V)	460(V)	400(V)	400(V)
<i>P 4</i>	V/F control mode selection		0	0	0	2
<i>F 3 0 7</i>	Supply voltage correction (output voltage limitation)		2	2	2	3
<i>F 3 1 9</i>	Regenerative over-excitation upper limit		120	120	120	140
<i>F 4 1 7</i>	Motor rated speed		1410(min <sup>-1</sup> )	1710(min <sup>-1</sup> )	1410(min <sup>-1</sup> )	1710(min <sup>-1</sup> )

Note 1) Excludes Japan.

Note 2) Slide switch SW1 is set to PLC side at default setting. Set it appropriately according to the logic used.  
Refer to page B-11 and 13 for details.

## Setting the frequency

- : (1) Setting using setting dial  
 (2) Setting using external signals  
 (0-10Vdc, 4-20mAdc, -10-+10Vdc)





Use the basic parameters  $CND$  (command mode selection) and  $FND$  (frequency setting mode selection) for selection.

[Parameter setting]

Title	Function	Adjustment range	Default setting
$CND$	Command mode selection	0: Terminal block 1: Panel keypad (including extension panel) 2: RS485 communication 3: CANopen communication 4: Communication option	1
$FND$	Frequency setting mode selection 1	0: Setting dial 1(save even if power is off) 1: Terminal VIA 2: Terminal VIB 3: Setting dial 2(press in center to save) 4: RS485 communication 5: UP/DOWN from external logic input 6: CANopen communication 7: Communication option 8: Terminal VIC 9, 10: - 11: Pulse train input 12, 13: - 14: $SRQ$	0

☆  $FND=0$  (setting dial 1) is the mode that after the frequency is set by the setting dial, the frequency is saved even if the power is turned off. The usage of this setting dial is similar to that of potentiometer.

☆ Refer to section 5.6 for details about  $FND=4$  to  $7$ ,  $11$ , and  $14$ .

	$\text{[ F r d ]}$	Turn the setting dial, and select " $\text{[ F r d ]}$ ".
	$!$	Press the center of the setting dial to read the parameter value. (Standard default: $!$ ).
	$0$	Turn the setting dial to change the parameter value to $0$ (terminal block).
	$0 \Rightarrow \text{[ F r d ]}$	Press the center of the setting dial to save the changed parameter. $\text{[ F r d ]}$ and the parameter set value are displayed alternately.

### (1) Run and stop using the panel keypad ( $\text{[ F r d ]} = !$ )

Use the **RUN** and **STOP** keys on the panel keypad to start and stop the motor.

**RUN**: Motor runs. **STOP**: Motor stops.

☆The direction of rotation is determined by the setting of parameter  $F_r$  (forward run, reverse run selection). ( $0$ : forward run,  $!$ : reverse run)

☆Forward run and reverse run are switchable with the extension panel (option). Set the parameter  $F_r$  (forward run, reverse run selection) to  $2$  or  $3$ . (Refer to section 5.8)

### (2) RUN and STOP using external signals ( $\text{[ F r d ]} = 0$ ): Sink (Negative) logic

Use external signals to the inverter terminal block to start and stop the motor.

Short **F** and **CC** terminals: run forward

Open **F** and **CC** terminals: slow down and stop

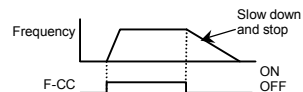

2) Assign "5b (FRR)" to an input terminal.  
Coast stop is done by shorting FRR and CC.

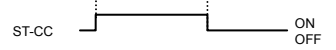



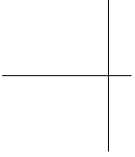

3

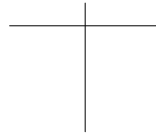
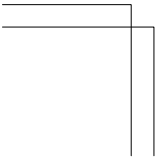

C-6





	<i>F 7 0 0</i>	Turn the setting dial, and select <i>F 7 0 0</i> .
	<i>0</i>	Press the center of the setting dial to read the parameter value. (Standard default: <i>0</i> ).
	<i>1</i>	Turn the setting dial to change the parameter value to <i>1</i> (terminal block VIA).
	<i>1</i> ⇄ <i>F 7 0 0</i>	The parameter value is written, <i>F 7 0 0</i> and the parameter value are displayed alternately several times.

\* Pressing the MODE key twice returns the display to standard monitor mode (displaying output frequency).

(1) Setting using the keypad (*F 7 0 0* = *0* or *3*)





: Moves the frequency up



: Moves the frequency down

■ Example of operating from the panel (*F 7 0 0* = *3*: press in center to save)

Panel operation	LED display	Operation
	<i>0.0</i>	Displays the output frequency. (When standard monitor display selection <i>F 7 1 0</i> = <i>0</i> [output frequency])
	<i>50.0</i>	Set the output frequency. (The frequency will not be saved if the power is turned off in this state.)
	<i>50.0</i> ⇄ <i>F 7</i>	Save the output frequency, <i>F 7</i> and the frequency are displayed alternately.

■ Example of operating from the panel (*F 7 0 0* = *0*: save even if power is off)

Panel operation	LED display	Operation
	<i>0.0</i>	Display the output frequency. (When standard monitor display selection is set as <i>F 7 1 0</i> = <i>0</i> [output frequency])
	<i>50.0</i>	Set the output frequency.
-	<i>50.0</i>	The frequency will be saved when the power is turned off in this state.

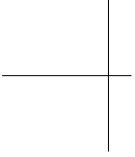

C-8

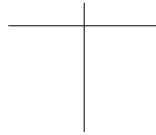
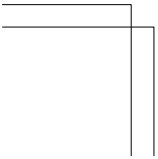

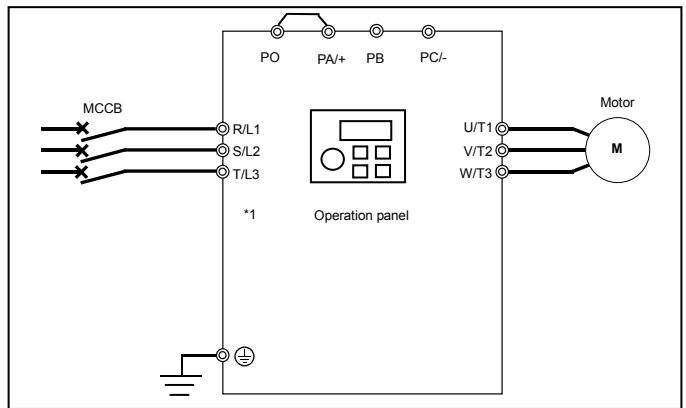
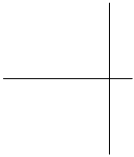

(2) Parameter setting (default setting)

Title	Function	Setting value
<i>Fn0d</i>	Command mode selection	<i>1</i>
<i>Fn0d</i>	Frequency setting mode selection 1	<i>0</i>

(3) Operation

Run/stop: Press the  and  keys on the panel.

Frequency setting: Turn the setting dial to set the frequency. The frequency setting is saved just by turning the setting dial.

\*1: Single-phase models are R/L1 and S/L2/N.

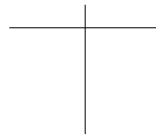
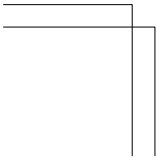

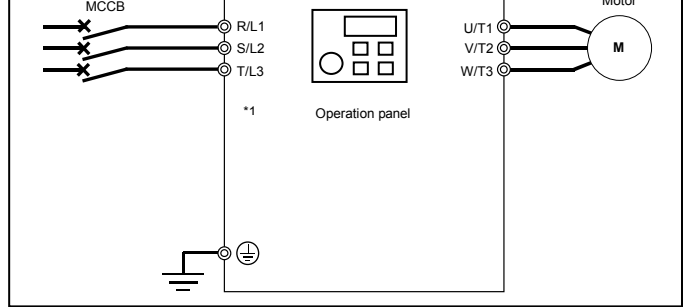

## (2) Parameter setting

Title	Function	Setting value
<i>FnFd</i>	Command mode selection	1
<i>FnFd</i>	Frequency setting mode selection 1	7

## (3) Operation

Run/stop: Press the  and  keys on the panel.

Frequency setting: Turn the setting dial to set the frequency.

To save the frequency setting, press the center of the setting dial.

*F<sub>LC</sub>* and the set frequency will flash on and off alternately, then set frequency will be retained.

The set frequency will be retained even if power supply is cut.

\*1: Single-phase models are R/L1 and S/L2/N.

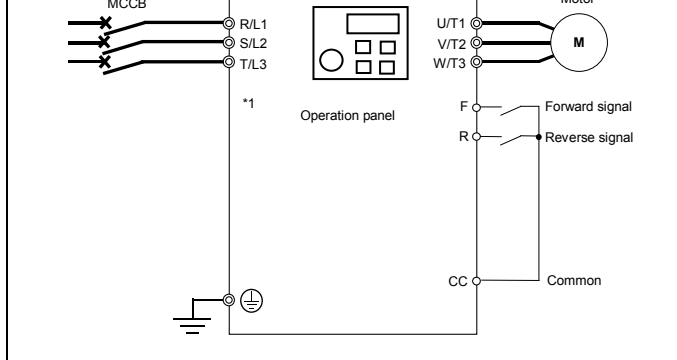

(2) Parameter setting

Title	Function	Setting value
<i>f f f d</i>	Command mode selection	<i>0</i>
<i>F f f d</i>	Frequency setting mode selection 1	<i>0 or 3</i>

(3) Operation

Run/stop: ON/OFF input to F-CC, R-CC. (with sink logic)

F is for forward run signal and R is for reverse run signal (default setting)

Frequency setting: Turn the setting dial to set the frequency.

\*1: Single-phase models are R/L1 and S/L2/N.

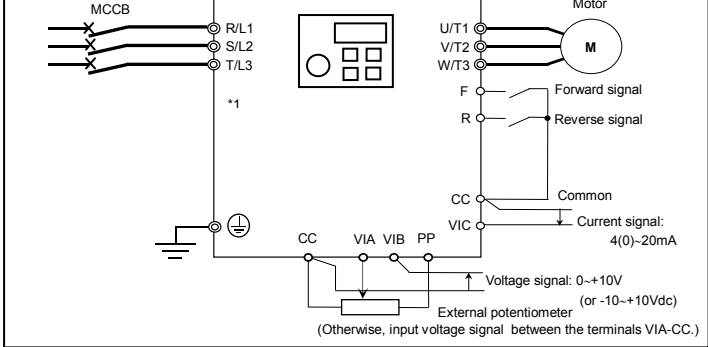

## (2) Parameter setting

Title	Function	Setting value
<i>F n Q d</i>	Command mode selection	<i>0</i>
<i>F n Q d</i>	Frequency setting mode selection 1	<i>1, 2 or 8</i>

## (3) Operation

Run/stop: ON/OFF input to F-CC, R-CC. (with sink logic)

F is for forward run signal and R is for reverse run signal (default setting)

Frequency setting: VIA: Input 0~+10V (external potentiometer), VIB: Input 0~+10V (or -10~+10Vdc) or VIC: 4(0)-20mA to set the frequency.

Set the selection of VIA, VIB or VIC in parameter *F n Q d*.

VIA : *F n Q d* = *1*

VIB : *F n Q d* = *2*

VIC : *F n Q d* = *8*

Refer to Chapter 7 for the setting of analog input characteristics.

\*1: Single-phase models are R/L1 and S/L2/N.

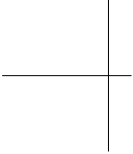

This mode is for monitoring the output frequency and setting the frequency reference value. It also displays information about status alarms during running and trips.

- Display of output frequency, etc.

$F 7 1 0$  Initial panel display selection

( $F 7 2 0$  Initial extension panel display selection)

$F 7 0 2$  Free unit display scale

- Setting frequency reference values.

- Status alarm

If there is an error in the inverter, the alarm signal and the frequency will flash alternately in the LED display.

$\overline{I}$  : When a current flows at or higher than the overcurrent stall prevention level.

$\overline{P}$  : When a voltage is generated at or higher than the over voltage stall prevention level.

$\overline{L}$  : When the cumulative amount of overload reaches 50% or more of the overload trip value, or when the main circuit element temperature reaches the overload alarm level

$H$  : When the overheat protection alarm level is reached

### Setting monitor mode

### The mode for setting inverter parameters.

⇒ How to set parameters, refer to section 4. 2.

There are two parameter read modes. Refer to section 4. 2 for details about selection and switching of modes.

**Easy setting mode** : Only the ten most frequently used parameters are displayed.

Parameters can be registered as necessary.

(max. 32 parameters)

**Standard setting mode** : Both basic and extended all parameters are displayed.

☆ Each press of the EASY key switches between the Easy setting mode and the Standard setting mode.

4

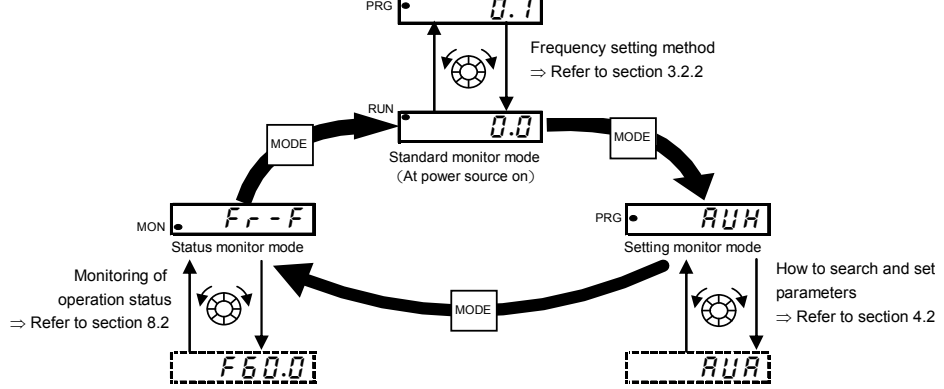





Used to select items and changing setting values. (Note)



Used to switch between the Easy and Standard setting modes. (Note)



Used to select the mode and return to the previous menu



Used to switch between the Easy and Standard setting modes.

**Easy setting mode**

: The mode changes to the Easy setting mode when the EASY key is pressed at the standard monitor mode and "EASY" is displayed. In the Easy setting mode, the EASY lamp lights.

Only the most frequently used 10 basic parameters are displayed at default setting.

Easy setting mode

Title	Function
<i>CMD</i>	Command mode selection
<i>FND</i>	Frequency setting mode selection 1
<i>ACC</i>	Acceleration time 1
<i>DEC</i>	Deceleration time 1
<i>UL</i>	Upper limit frequency
<i>LL</i>	Lower limit frequency
<i>ELT</i>	Motor electronic-thermal protection level 1
<i>FA</i>	Meter adjustment gain
<i>FUI</i>	Current/voltage unit selection
<i>PEL</i>	EASY key mode selection

☆ If the EASY key is pressed while the setting dial is being turned, values continue to be incremented or decremented even if you release your finger from the setting dial. This feature is handy when setting large values.

Note) Of the available parameters, number value parameters (*ACC* etc.) are reflected in actual operation when the setting dial is turned. Note, however, that the center of the setting dial must be pressed to save values even when the power is turned off.

Note, also, that item selection parameters (*FND* etc.) are not reflected in actual operation by just turning the setting dial. To reflect these parameters, press the center of the setting dial.

Extended parameters

: The parameters for detailed and special setting.

⇒ Refer to chapter 6 for details.

⇒ Refer to section 11.3 for parameter tables.

4

Note) There are the parameters that cannot be changed during inverter running for reasons of safety. Refer to section 11.9.

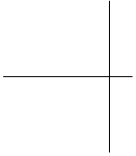

---

D-4

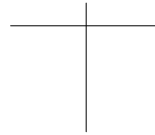
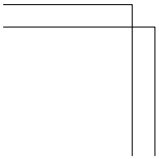

<i>dEL</i>	Deceleration time 1
<i>UL</i>	Upper limit frequency
<i>LL</i>	Lower limit frequency
<i>tHr</i>	Motor electronic-thermal protection level 1
<i>FN</i>	Meter adjustment gain
<i>F701</i>	Current/voltage unit selection
<i>PSEL</i>	EASY key mode selection

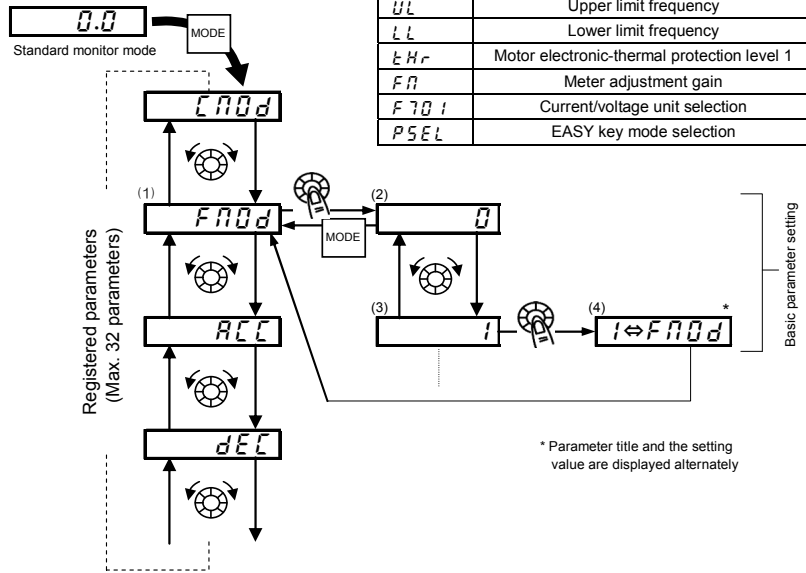

■ Setting parameters in the Easy setting mode

- (1) Select parameter to be changed. (Turn the setting dial.)
- (2) Read the programmed parameter setting. (Press the center of the setting dial.)
- (3) Change the parameter value. (Turn the setting dial.)
- (4) Press this key to save the parameter value. (Press the center of the setting dial.)

☆ To switch to the Standard setting mode, press the EASY key in the Standard monitor mode. "5 t d" is displayed, and the mode is switched.

(3) Change the parameter value. (Turn the setting dial.)

(4) Press this key to save the parameter value.  
(Press the center of the setting dial.)

4

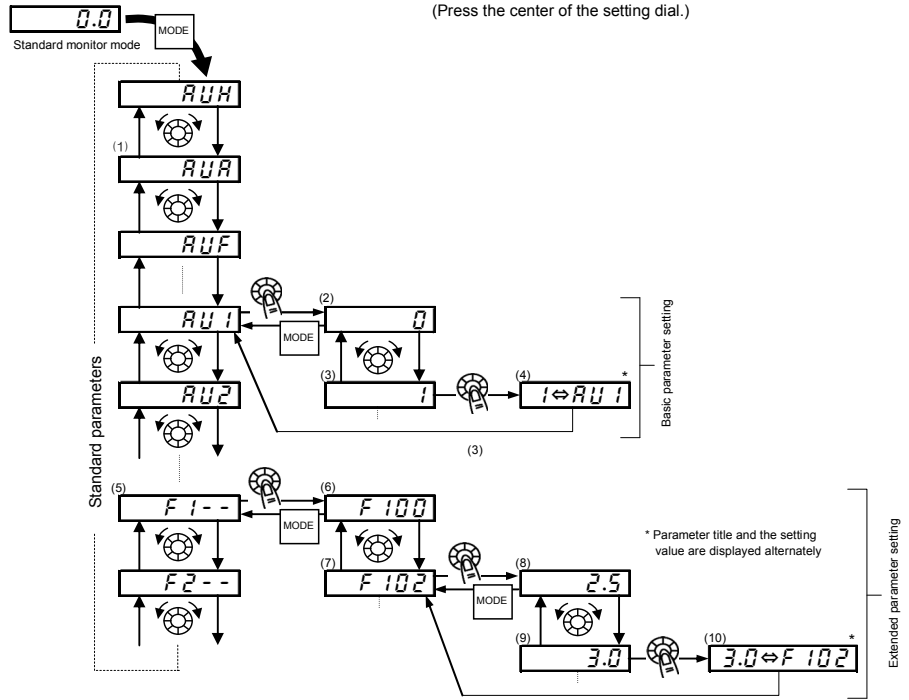

☆ To switch to the Easy setting mode, press the EASY key in the Standard monitor mode. *EASY* is displayed, and the mode is switched.

(9) Change the parameter value. (Turn the setting dial.)

(10) Press this key to save the parameter value. (Press the center of the setting dial.)

■ Adjustment range and display of parameter setting value

$H \uparrow$ : An attempt has been made to assign a value that is higher than the programmable range.

$L \downarrow$ : An attempt has been made to assign a value that is lower than the programmable range.

If the above alarm is flashing on and off, values that exceed  $H \uparrow$  or are equal or lower than  $L \downarrow$  cannot be set.

\* A setting value of the presently-selected parameter might exceed the upper limit or the lower limit by changing other parameters.

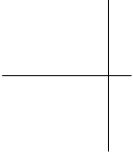

## 4.3 Functions useful in searching for a parameter or changing a parameter setting

---

This section explains functions useful in searching for a parameter or changing a parameter setting.

Changed parameters history search (History function) **RUH**

This function automatically searches for the last five parameters whose settings have been changed. To use this function, select the **RUH** parameter. (The changed parameters are displayed regardless of difference with the default settings.)

⇒ Refer to section 5.1 for details.

Easy setting parameters according to application (Application easy setting) **REA**

The necessary parameter for your machine can be easily set.

Select the machine by parameter **REA** and set by using the easy setting mode.

⇒ Refer to section 5.2 for details.

Use the  $\text{tYP}$  parameter to reset all parameters back to the default settings. To use this function, set parameter  $\text{tYP} = 3$  or  $13$ .

⇒ Refer to section 4.3.2 for details.

# 4

Call saved customer settings  $\text{tYP}$

Customer settings can be batch-saved and batch-called.

These settings can be used as customer-exclusive default settings.

To use this function, set parameter  $\text{tYP} = 7$  or  $8$ .

⇒ Refer to section 4.3.2 for details.

Search changed parameters  $\text{tRU}$

Automatically searches for only those parameters that are programmed with values different from the default setting.

To use this function, select the  $\text{tRU}$  parameter.

⇒ Refer to section 4.3.1 for details.

## 4.3.1 Searching for and resetting changed parameters

$\text{tRU}$ : Automatic edit function

### • Function











Automatically searches for only those parameters that are programmed with values different from the default setting and displays them in the  $\text{tRU}$ . Parameter setting value can also be changed while searching.

Note 1: If you reset a parameter to its factory default, the parameter will no longer appear in  $\text{tRU}$ .

Note 2: It may take several seconds to display changed parameters because all data stored in  $\text{tRU}$  is checked against the default settings. To cancel a parameter search, press the MODE key.

Note 3: Parameters which cannot be reset to the default setting after setting  $\text{tYP}$  to  $3$  are not displayed.

⇒ Refer to section 4.3.2 for details.

	<i>U - -</i>	Press the center of the setting dial to enter the user parameter setting change search mode.
 or 	<i>RCC</i>	Searches for and displays parameters different to the default settings. Parameters are changed by either pressing the center of the setting dial or turning it to the right. (Turning the setting dial to the left searches for parameter in the reverse direction.)
	<i>B.0</i>	Press the center of the setting dial to display set values.
	<i>S.0</i>	Turn the setting dial, and change set values.
	<i>S.0 ⇄ RCC</i>	Press the center of the setting dial to set values. The parameter name and set value light alternately and are written.
	<i>U - - F</i> <i>(U - - r)</i>	Use the same steps as those above and turn the setting dial to display parameters to search for or whose settings must be changed, and check or change the parameter settings.
	<i>GrU</i>	When <i>GrU</i> appears again, the search is ended.
  	Parameter display ↓ <i>GrU</i> ↓ <i>F r - F</i> ↓ <i>0.0</i>	A search can be canceled by pressing the MODE key. Press the key once while the search is underway to return to the display of parameter setting mode. Returns to the <i>GrU</i> display. After that press the MODE key and return to the status monitor mode or the standard monitor mode (display of output frequency).

4

Parameter setting		Adjustment range	Default setting
$\text{t Y P}$	Default setting	0: - 1: 50Hz default setting 2: 60Hz default setting 3: Default setting 1 (Initialization) 4: Trip record clear 5: Cumulative operation time clear 6: Initialization of type information 7: Save user setting parameters 8: Load user setting parameters 9: Cumulative fan operation time record clears 10, 11: - 12: Number of starting clear 13: Default setting 2 (complete initialization)	0

★ This function will be displayed as 0 during reading on the right. This previous setting is displayed.

Example:

★  $\text{t Y P}$  cannot be set during the inverter operating. Always stop the inverter first and then program.

### Programmed value

50 Hz default setting ( $\text{t Y P} = 1$ )

Setting  $\text{t Y P}$  to 1 sets the following parameters for base frequency 50 Hz use.

(The setting values of other parameters are not changed.)

- Maximum frequency ( $F H$ ) : 50Hz
- Base frequency 1 ( $\omega L$ ) : 50Hz
- VIA input point 2 frequency ( $F 2 0 4$ ) : 50Hz
- VIC input point 2 frequency ( $F 2 1 9$ ) : 50Hz
- Process upper limit ( $F 3 6 7$ ) : 50Hz
- Motor rated speed ( $F 4 1 7$ ) : 1410 min<sup>-1</sup>
- Upper limit frequency ( $U L$ ) : 50Hz
- Base frequency 2 ( $F 1 7 0$ ) : 50Hz
- VIB input point 2 frequency ( $F 2 1 3$ ) : 50Hz
- Automatic light-load high-speed operation frequency ( $F 3 3 0$ ) : 50Hz
- Communication command point 2 frequency ( $F 8 1 4$ ) : 50Hz



Default setting 1 (E Y P = 3)

Setting E Y P to 3 will return parameters to the default settings (exclusive of some parameters).

☆ When 3 is set, **10 14** is displayed for a short time after the settings are configured, and then disappears. Then the inverter is in standard motor mode. In this case, the trip history data is cleared.

Be aware that the following parameters do not return to the default settings even if E Y P=3 is set for maintainability. (To initialize all parameters, set E Y P= 13)

- **R 4 L** : Overload characteristic selection
- **F 4 7 0 ~ F 4 7 5** : VIA/VIB/VIC input bias / gain
- **F 0 5 L** : Meter selection
- **F 6 6 9** : Logic output/pulse train output selection
- **F 0** : Meter adjustment gain
- **F 6 8 1** : Analog output signal selection
- **S E L** : Checking the region setting
- **F 6 9 1** : Inclination characteristic of analog output
- **F 1 0 7** : Analog input terminal selection
- **F 6 9 2** : Analog output bias
- **F 1 0 9** : Analog/logic input selection (VIA/VIB)
- **F 8 8 0** : Free notes

\* Refer to "Communication manual" about parameter [ xxx.

Trip record clear (E Y P = 4)

Setting E Y P to 4 initializes the past eight sets of recorded error history data.

☆ The parameter does not change.

Cumulative operation time clear (E Y P = 5)

Setting E Y P to 5 resets the cumulative operation time to the initial value (zero).

Initialization of type information (E Y P = 6)

Setting E Y P to 6 clears the trips when an E E Y P format error occurs. But if the E E Y P displayed, contact your Toshiba distributor.

# 4

## Cumulative fan operation time record clear ( $t_{Y P} = 9$ )

Setting  $t_{Y P}$  to 9 resets the cumulative operation time to the initial value (zero).  
Set this parameter when replacing the cooling fan, and so on

## Number of starting clear ( $t_{Y P} = 12$ )

Setting  $t_{Y P}$  to 12 resets the number of starting to the initial value (zero).

## Default setting 2 ( $t_{Y P} = 13$ )

Set  $t_{Y P}$  to 13 to return all parameters to their default settings.  
When 13 is set,  $\overline{1.0 1.1}$  is displayed for a short time after the settings are configured, and then disappears. Then setup menu 5 E t is displayed. After reviewing the setup menu items, make a setup menu selection. In this case, all parameters are returned to their defaults, and the trip history data is cleared. (Refer to section 3.1)

[Parameter setting]

Title	Function	Adjustment range	Default setting
5 E t	Checking the region setting	0: Start setup menu 1: Japan (read only) 2: North America (read only) 3: Asia (read only) 4: Europe (read only)	1 *

\* Default setting values vary depending on the setup menu setting. 1 to 4 are displayed.

■ Content of region settings

The number displayed when parameter 5 E t is read indicates which of the following regions was selected on the setup menu.

4: EU (Europe) is selected on the setup menu.

3: AS OR (Asia, Oceania) is selected on the setup menu.

2: USR (North America) is selected on the setup menu.

1: JP (Japan) is selected on the setup menu.

The setup menu is started by setting 5 E t = 0.

Refer to section 3.1 for details.

Note: 1 to 4 set to parameter 5 E t are read-only. They cannot be written.

- Up to 32 arbitrary parameters can be registered to easy setting mode.  
The EASY key can select following four functions.
- Easy / Standard setting mode switching function
  - Shortcut key function
  - Local / Remote switching function
  - Peak hold function

[Parameter setting]

Title	Function	Adjustment range	Default setting
P5EL	EASY key mode selection	0: Standard setting mode at power on 1: Easy setting mode at power on 2: Easy setting mode only	0
F75Q	EASY key function selection	0: Easy / standard setting mode switching function 1: Shortcut key 2: Local / remote key 3: Monitor peak / minimum hold trigger	0

■ **Easy / Standard setting mode switching function (F75Q=0): Default setting**

It is possible to switch between standard mode and easy setting mode when you push the EASY key while the inverter is stopping.

Standard setting mode is selected when the power is turned on at default setting.

The way parameters are read out and displayed varies according to the mode selected.

**Easy setting mode**

Allows pre-registration (easy setting mode parameters) of frequently changed parameters and reading of only registered parameters (maximum of 32 types).

In the Easy setting mode, the EASY key lamp lights.

**Standard setting mode**

Standard setting mode in which all parameters are read out.

[How to read out parameters]

Use the EASY key to change between Easy setting mode and Standard setting mode, and then press the MODE key to enter the setting monitor mode.

Turn the setting dial to read the parameter.

The relation between the parameter and the mode selected is shown below.

**PSEL=2**

\* Always in easy setting mode.

However, it can be switched to standard setting mode by EASY key if it is set to  $PSEL=0, 1$ . When  $PSEL$  is not displayed in Easy setting mode,  $UnD$  is displayed and it can be temporarily switched to standard setting mode by EASY key after center of the setting dial is pushed for five seconds or more.

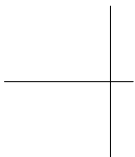

D-15

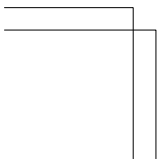

4

<i>F 752</i>	Easy setting mode parameter 2	<i>0-2999</i>	<i>4 (Fn0d)</i>
<i>F 753</i>	Easy setting mode parameter 3	<i>0-2999</i>	<i>9 (RCC)</i>
<i>F 754</i>	Easy setting mode parameter 4	<i>0-2999</i>	<i>10 (dEC)</i>
<i>F 755</i>	Easy setting mode parameter 5	<i>0-2999</i>	<i>12 (UL)</i>
<i>F 756</i>	Easy setting mode parameter 6	<i>0-2999</i>	<i>13 (LL)</i>
<i>F 757</i>	Easy setting mode parameter 7	<i>0-2999</i>	<i>600 (tHr)</i>
<i>F 758</i>	Easy setting mode parameter 8	<i>0-2999</i>	<i>6 (Fn)</i>
<i>F 759</i>	Easy setting mode parameter 9	<i>0-2999</i> (Set by communication number)	<i>999</i> (No function)
<i>F 760</i>	Easy setting mode parameter 10		
<i>F 761</i>	Easy setting mode parameter 11		
<i>F 762</i>	Easy setting mode parameter 12		
<i>F 763</i>	Easy setting mode parameter 13		
<i>F 764</i>	Easy setting mode parameter 14		
<i>F 765</i>	Easy setting mode parameter 15		
<i>F 766</i>	Easy setting mode parameter 16		
<i>F 767</i>	Easy setting mode parameter 17		
<i>F 768</i>	Easy setting mode parameter 18		
<i>F 769</i>	Easy setting mode parameter 19		
<i>F 770</i>	Easy setting mode parameter 20		
<i>F 771</i>	Easy setting mode parameter 21		
<i>F 772</i>	Easy setting mode parameter 22		
<i>F 773</i>	Easy setting mode parameter 23		
<i>F 774</i>	Easy setting mode parameter 24		
<i>F 775</i>	Easy setting mode parameter 25		
<i>F 776</i>	Easy setting mode parameter 26		
<i>F 777</i>	Easy setting mode parameter 27		
<i>F 778</i>	Easy setting mode parameter 28		
<i>F 779</i>	Easy setting mode parameter 29		
<i>F 780</i>	Easy setting mode parameter 30		
<i>F 781</i>	Easy setting mode parameter 31	<i>0-2999</i>	<i>701 (F701)</i>
<i>F 782</i>	Easy setting mode parameter 32	<i>0-2999</i>	<i>50 (PSEL)</i>

Note: If any number other than communication numbers is specified, it is regarded as *999* (no function assigned).

■ **Local / Remote switching (F 750=2)**

This function allows you to easily switch between panel operation and external operation.

To switch between control device, set F 750 to 2, and then select the desired control device, using the EASY key.

If bumpless operation selection F 295 is set to 1 (Enabled), it can be switched during operation.

Local means panel operation.

Remote means the operation that is selected by command mode selection: C n0d and frequency setting mode selection: F n0d (F 207).

In the Local mode, the EASY key lamp lights.

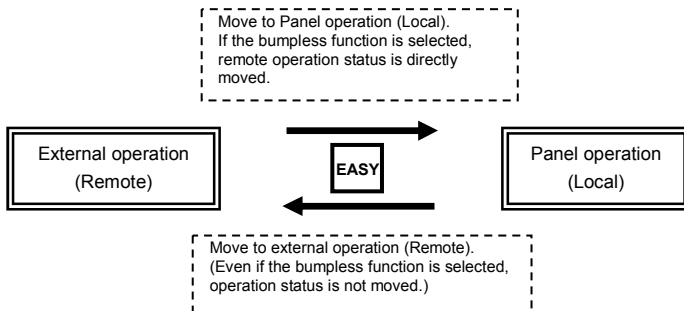

Note) Please note that if set the parameter F 750 to 0 in local mode, the panel operation state holds and it becomes different from setting of C n0d.

■ **Peak hold function (F 750=3)**

This function allows you to set peak hold and minimum hold triggers for parameters F 709, using the EASY key.

The measurement of the minimum and maximum values set for F 709 starts the instant when you press the EASY key after setting F 750 to 3.

The peak hold and minimum hold values are displayed in absolute values.

- Function

Output of 0 - 1mAdc, 0 (4) - 20mAdc, 0 - 10vdc can be selected for the output signal from the FM terminal, depending on the  $F581$  setting. Adjust the scale at  $F7$ .

Use an ammeter with a full-scale 0 - 1mAdc meter.



The  $F592$  (analog output bias) needs to be adjusted if output is 4 - 20mAdc.

[Parameter setting]

Title	Function	Adjustment range	Supposition output at $F75L=17$	Default setting
$F75L$	Meter selection	0: Output frequency 1: Output current 2: Frequency command value 3: Input voltage (DC detection) 4: Output voltage (command value) 5: Input power 6: Output power 7: Torque 8: - 9: Motor cumulative load factor 10: Inverter cumulative load factor 11: PBR (Braking resistor) cumulative load factor 12: Stator frequency 13: VIA input value 14: VIB input value 15: Fixed output 1 (output current 100% equivalent) 16: Fixed output 2 (output current 50% equivalent) 17: Fixed output 3 (Other than the output current) 18: RS485 communication data 19: For adjustments ( $F7$ set value is displayed.) 20: VIC input value 21: Pulse train input value 22: - 23: PID feedback value 24: Integral input power 25: Integral output power	Maximum frequency ( $FH$ ) - Maximum frequency ( $FH$ ) 1.5x rated voltage 1.5x rated voltage 1.85x rated power 1.85x rated power 2.5x rated torque - Rated load factor Rated load factor Rated load factor Maximum frequency ( $FH$ ) Maximum input value Maximum input value - - - Maximum value (100.0%) - Maximum input value Maximum input value - Maximum frequency ( $FH$ ) 1000x $F749$ 1000x $F749$	0
$F7$	Meter adjustment gain	-	-	-

■ Resolution: All FM terminals have a maximum of 1/1000.









- CC  The reading of the meter will fluctuate during scale adjustment.
- CC  The reading of the meter will fluctuate during scale adjustment.
- \* Optional QS-60T frequency meter is available.
  - \* Meter with a maximum scale of 1.5x the inverter's rated output current is recommended.

5

[Example of how to adjust the FM terminal frequency meter]

\* Use the meter's adjustment screw to pre-adjust zero-point.

\* Adjust  $F 6 9 1$  and  $F 6 9 2$  in advance in case of 4-20mA output.

Operation panel action	LED display	Operation
-	60.0	Displays the output frequency. (When standard monitor display selection $F 7 1 0$ is set to 0)
	RUM	The first basic parameter "RUM" (history function) is displayed.
	F $\bar{n}$	Turn the setting dial to select $F \bar{n}$ .
	60.0	Output frequency can be displayed by pressing the center of the setting dial.
	60.0	Turn the setting dial to adjust the meter. <u>The meter's indicator will change by turning setting dial.</u> (The inverter displays output frequency and it will not change with the setting dial)
	60.0 $\leftrightarrow$ F $\bar{n}$	Press the center of the setting dial to save the meter's adjustments. F $\bar{n}$ and the frequency are displayed alternately.
 + 	60.0	The display returns to displaying output frequency. (When standard monitor display selection $F 7 1 0$ is set to 0 [output frequency])

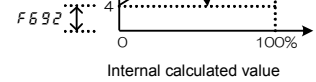
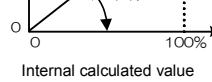

Note 1) When using the FM terminal for current output, be sure that the external load resistance is less than  $600\Omega$ .  
Use over  $1k\Omega$  external load resistance for voltage output.

Note 2)  $F\dot{N}S\dot{L} = \dot{i}2$  is the motor drive frequency.

### ■ Adjusting the meter in inverter stop state

- Adjustment of the meter for output current ( $F\dot{N}S\dot{L} = \dot{i}$ )

Adjustment of the meter for output current can be done in inverter stop state.

When setting  $F\dot{N}S\dot{L}$  to  $\dot{i}5$  for fixed output 1 (output current 100% equivalent), a signal assuming that inverter rated current (output current 100% equivalent) passes will be output from the FM terminal.

Adjust the meter with the  $F\dot{N}$  (Meter adjustment) parameter in this state.

Similarly, if you set  $F\dot{N}S\dot{L}$  to  $\dot{i}6$  for fixed output 2 (output current 50% equivalent), a signal assuming that 50% of inverter rated current (output current 50% equivalent) passes will be output from the FM terminal.

After meter adjustment is ended, set  $F\dot{N}S\dot{L}$  to  $\dot{i}$  (output current).

- Other adjustments ( $F\dot{N}S\dot{L} = 0, 2$  to  $7, 9$  to  $14, 18, 20, 21, 23$  to  $25$ )

$F\dot{N}S\dot{L} = \dot{i}7$ : When fixed output 3 (other than the output current) is set, a signal of the value for other monitors is fixed at the following values and output through the FM terminal.

100% standard value for each item is the following:

$F\dot{N}S\dot{L} = 0, 2, 12, 23$	: Maximum frequency ( $FH$ )
$F\dot{N}S\dot{L} = 3, 4$	: 1.5 times of rated voltage
$F\dot{N}S\dot{L} = 7$	: 2.5 times of rated torque
$F\dot{N}S\dot{L} = 9$ to $11$	: Rated load factor
$F\dot{N}S\dot{L} = 13, 14, 20, 21$	: Maximum input value (10V, or 20mA)
$F\dot{N}S\dot{L} = 18$	: Maximum value (100.0%)
$F\dot{N}S\dot{L} = 24, 25$	: $1000 \times F\dot{1}49$

from 0.0Hz to maximum frequency  $FH$ .

- 2) For deceleration time 1  $dEL$  programs the time that it takes for the inverter output frequency to go from maximum frequency  $FH$  to 0.0Hz.

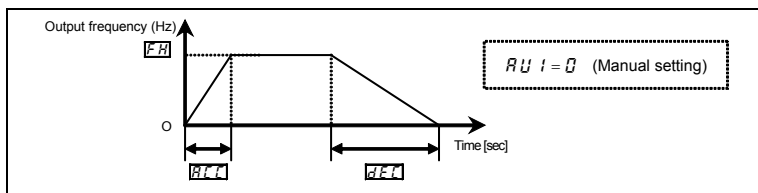

[Parameter setting]

Title	Function	Adjustment range	Default setting
$AEL$	Acceleration time 1	0.0-3600 (360.0) (s)	10.0
$dEL$	Deceleration time 1	0.0-3600 (360.0) (s)	10.0
$F519$	Setting of acceleration/deceleration time unit	0: - 1: 0.01s unit (after execution: 0) 2: 0.1s unit (after execution: 0)	0

Note1): Setting increment unit can be changed to 0.01 seconds by parameter  $F519$ .

Note2):  $F519=2$ : When the acceleration/deceleration time is set to 0.0 seconds, the inverter accelerates and decelerates 0.05 seconds.

$F519=1$ : When the acceleration/deceleration time is set to 0.00 seconds, the inverter accelerates and decelerates 0.01 seconds.

★ If the programmed value is shorter than the optimum acceleration/deceleration time determined by load conditions, overcurrent stall or overvoltage stall function may make the acceleration/deceleration time longer than the programmed time. If an even shorter acceleration/deceleration time is programmed, there may be an overcurrent trip or overvoltage trip for inverter protection. (Refer to section 13.1 for details)

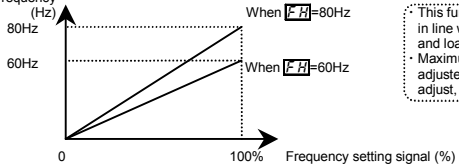

This function determines the value in line with the ratings of the motor and load.  
 • Maximum frequency cannot be adjusted during operation. To adjust, first stop the inverter.

★ If  $FH$  is increased, adjust the upper limit frequency  $UL$  as necessary.

[Parameter setting]

Title	Function	Adjustment range	Default setting
$FH$	Maximum frequency	30.0-500.0 (Hz)	80.0

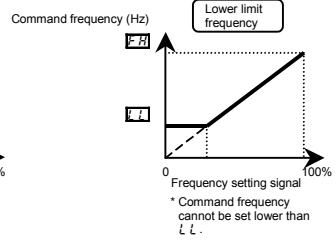
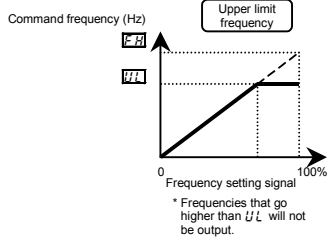

[Parameter setting]

Title	Function	Adjustment range	Default setting
UL	Upper limit frequency	0.5 - FH (Hz)	*1
LL	Lower limit frequency	0.0 - UL (Hz)	0.0

\* 1: Default setting values vary depending on the setup menu setting. Refer to section 11.5.

Note1) Do not set a value 10 times larger than LL (base frequency 1) and F17Q (base frequency 2) for UL.

If a large number is set, the output frequency can only be output at 10 times of minimum value LL and F17Q and R-DS alarm is displayed.

Note2) Output frequency lower than parameter F24Q (Starting frequency) is not output. Parameter F24Q setting is needed.

Base frequency voltage  
 $\omega \dot{L} \omega$

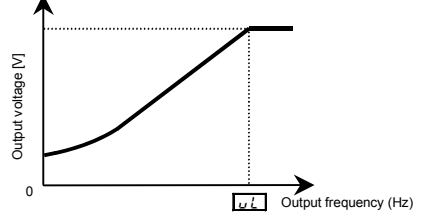

[Parameter setting]

Title	Function	Adjustment range	Default setting
$\omega \dot{L}$	Base frequency 1	20.0-500.0 (Hz)	*1
$\omega \dot{L} \omega$	Base frequency voltage1	50-330 (240V class) 50-660 (500V class)	*1

\* 1: Default setting values vary depending on the setup menu setting. Refer to section 11.5.

**F507** : Motor 150% overload detection time

**F531** : Inverter overload detection method

**F532** : Electronic-thermal memory

**F557** : Overload alarm level

- Function  
This parameter allows selection of the appropriate electronic thermal protection characteristics according to the particular rating and characteristics of the motor.

[Parameter setting]

Title	Function	Adjustment range				Default setting
<i>F507</i>	Overload characteristic selection	0: - *4 1: Constant torque characteristic (150%-60s) 2: Variable torque characteristic (120%-60s)				0
<i>tHr</i>	Motor electronic-thermal protection level 1	10 – 100 (%) / (A) *1				100
<i>OLn</i>	Electronic-thermal protection characteristic selection	Setting value		Overload protection	Overload stall	0
		0	Standard motor	valid	invalid	
		1		valid	valid	
		2		invalid	invalid	
		3		invalid	valid	
		4	VF motor (special motor)	valid	invalid	
		5		valid	valid	
		6		invalid	invalid	
7	invalid	valid				
<i>F173</i>	Motor electronic-thermal protection level 2	10 – 100 (%) / (A) *1				100
<i>F507</i>	Motor 150% overload detection time	10 – 2400 (s)				300
<i>F531</i>	Inverter overload detection method	0: 150%-60s (120%-60s) 1: Temperature estimation				0

selected, it can be set at A (amps).

\*2:  $F532 = I$ : Electronic-thermal statuses (cumulative overload value) of motor and inverter are saved when power supply is OFF. It is calculated from the saved value when power supply is ON again.

\*3: Parameter  $RUL$  is displayed as "0" during reading after this is set.

Present setting of inverter overload characteristic can be confirmed by status monitor.

Refer to monitor "Overload and region setting" of section 8.2.1.

### 1) Setting the electronic thermal protection characteristics selection $OLN$ and motor electronic thermal protection level 1 $ELR$ , 2 $F173$

The electronic thermal protection characteristics selection ( $OLN$ ) is used to enable or disable the motor overload trip function ( $OL2$ ) and the overload stall function.

While the inverter overload trip ( $OLI$ ) will be in constantly detective operation, the motor overload trip ( $OL2$ ) can be selected using the parameter  $OLN$ .

#### Explanation of terms

Overload stall: This is an optimum function for equipment such as fans, pumps and blowers with variable torque characteristics that the load current decreases as the operating speed decreases.

When the inverter detects an overload, this function automatically lowers the output frequency before the motor overload trip ( $OL2$ ) is activated. With this function, operation can be continued, without tripping, by operating using a frequency balanced by load current.

Note: Do not use the overload stall function with loads having constant torque characteristics (such as conveyor belts in which load current is fixed with no relation to speed).

### [Using standard motors (other than motors intended for use with inverters)]

When a motor is used in the lower frequency range than the rated frequency, that will decrease the cooling effects for the motor. This speeds up the start of overload detection operations when a standard motor is used in order to prevent overheating.



- Setting of motor electronic thermal protection level [ $\epsilon H r$ ] (Same as [ $r r$ ])  
When the capacity of the motor in use is smaller than the capacity of the inverter, or the rated current of the motor is smaller than the rated current of the inverter, adjust thermal protection level 1  $\epsilon H r$  for the motor in accordance with the motor's rated current.

\* When displaying as a percentage, 100% = rated output current (A) of the inverter is displayed.

Output current reduction factor  
[%]/[A]

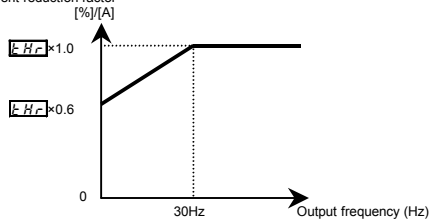

Note: The motor overload protection start level is fixed at 30Hz.

[Example of setting: When the VFS15-2007PM-W is running with a 0.4kW motor having 2A rated current]

Operation panel action	LED display	Operation
	0.0	Displays the output frequency. (Perform during operation stopped.) (When standard monitor display selection $F 7 i 0$ is set to 0 [output frequency])
MODE	R U H	The first basic parameter "R U H" (history function) is displayed.
	$\epsilon H r$	Turn the setting dial to change the parameter to $\epsilon H r$ .
	100	Parameter values can be read by pressing the center of the setting dial (default setting is 100%).
	42	Turn the setting dial to change the parameter to 42% (= motor rated current/inverter rated output current $\times 100 = 2.0/4.8 \times 100$ )
	42 $\Leftrightarrow$ $\epsilon H r$	Press the center of the setting dial to save the changed parameter. $\epsilon H r$ and the parameter are displayed alternately.

Note: The rated output current of the inverter should be calculated from the rated output current for frequencies below 4kHz, regardless of the setting of the PWM carrier frequency parameter ( $F 300$ ).

VV motors (motors designed for use with inverters) can be used in frequency ranges lower than those for standard motors, but their cooling efficiency decreases at frequencies below 6Hz.

■ Setting of motor electronic thermal protection level 1  $\boxed{F47}$  (Same as  $\boxed{F173}$ )

If the capacity of the motor is smaller than the capacity of the inverter, or the rated current of the motor is smaller than the rated current of the inverter, adjust the electronic thermal protection level 1  $\boxed{F47}$  so that it fits the motor's rated current.

\* If the indications are in percentages (%), then 100% equals the inverter's rated output current (A).

Output current reduction factor [%][A]

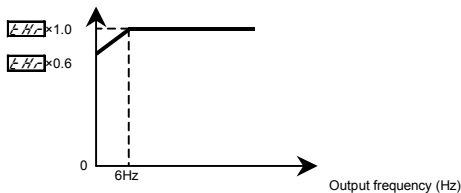

Note) The start level for motor overload reduction is fixed at 6 Hz.

2) Motor 150%-overload detection time  $\boxed{F507}$

Parameter  $\boxed{F507}$  is used to set the time elapsed before the motor trips under a load of 150% (overload trip  $\boxed{D12}$ ) within a range of 10 to 2400 seconds.

3) Inverter overload detection method  $\boxed{F531}$

As this function is set to protect the inverter unit, this function cannot be turned off by parameter setting. The inverter overload detection method can be selected using parameter  $\boxed{F531}$  (Inverter overload detection method).

[Parameter setting]

Title	Function	Adjustment range	Default setting
$\boxed{F531}$	Inverter overload detection method	0: 150%-60s (120%-60s) 1: Temperature estimation	0

If the inverter overload trip function ( $\boxed{D11}$ ) is activated frequently, this can be improved by adjusting the stall operation level  $\boxed{F501}$  downward or increasing the acceleration time  $\boxed{R11}$  or deceleration time  $\boxed{dE1}$ .

5

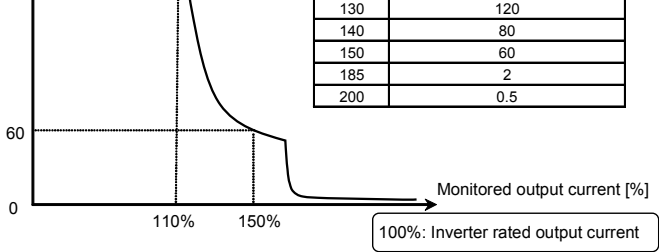

Inverter overload protection characteristics

- $F63\ i=1$  (Temperature estimation),  $RUL = 1$  (Constant torque characteristic)

This parameter adjusts automatically overload protection, predicting the inverter internal temperature rise. (diagonally shaded area in the figure below)

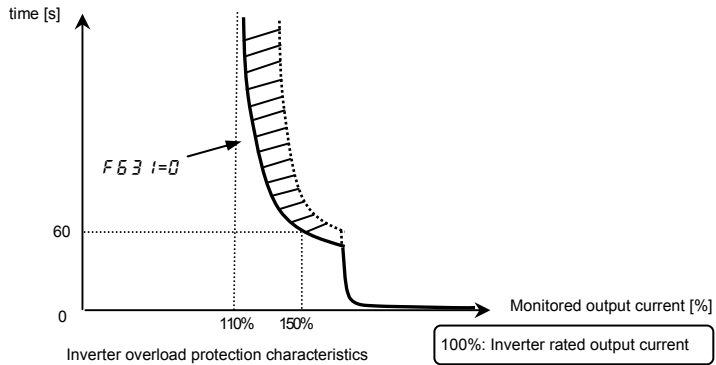

Inverter overload protection characteristics

#### 4) Electronic thermal memory **F632**

When the power is OFF, it is possible to reset or maintain the overload totaling level.

This parameter's settings are applied both to the motor's electronic thermal memory and the electronic thermal memory for inverter protection.

[Parameters settings]

Title	Function	Adjustment range	Default setting
F632	Electronic thermal memory	0: Disabled ( $t_{HR}$ , F173) 1: Enabled ( $t_{HR}$ , F173) 2: Disabled ( $t_{HR}$ ) 3: Enabled ( $t_{HR}$ )	0

☆ F632 = 1 is a function for complying with the U.S. NEC standards.

☆ Regarding to characteristic for  $RUL = 1$  setting, refer to section 3.5.3).

Note 1) In case of  $RUL = 2$  setting, be sure to install the input AC reactor (ACL) between power supply and inverter.

■  $RUL = 2$  (Variable torque characteristic),  $F \delta 3 I = 0$  (120%-60s)

5

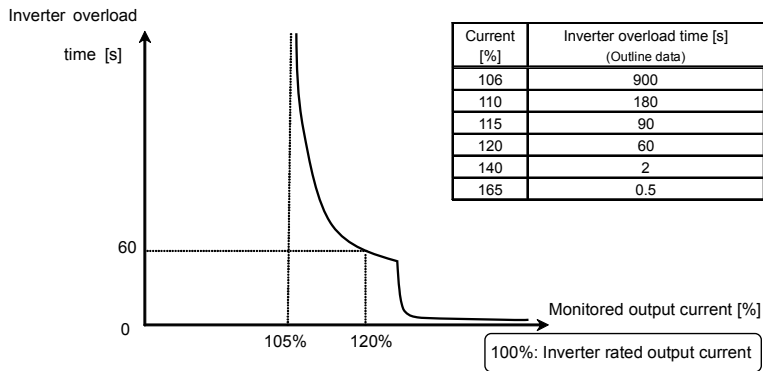

Inverter overload protection characteristic

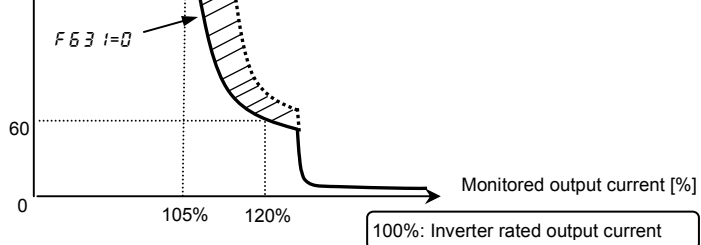

Note 1: The rated output current of inverter is changed by setting of  $F63$  =  $i$  or  $0$ .

Refer to page L-1 about each rated output current.

Note 2: Parameter  $F63$  is displayed as "0" during reading after this is set.

Note 3: Present setting of inverter overload characteristic can be confirmed by status monitor.

Refer to monitor "Overload and region setting" of section 8.2.1.

## 6) Overload alarm level $F657$

When the motor overload level reaches to  $F657$  setting value (%) of overload trip ( $OL2$ ) level, "L" will be displayed on the left side digit and the "L" and output frequency monitor will be blinking alternately on overload alarm status.

Overload alarm signal can be output from output terminal.

[Parameters settings]

Title	Function	Adjustment range	Default setting
$F657$	Overload alarm level	10-100 (%)	50

[Example of setting]: Assigning the overload alarm to the OUT terminal.

Title	Function	Adjustment range	Setting
$F131$	Output terminal selection 2A (OUT)	0-255	16: POL

17 is reverse signal.

- Function

A maximum of 15 speed steps can be selected just by switching an external logic signal. Multi-speed frequencies can be programmed anywhere from the lower limit frequency  $L_L$  to the upper limit frequency  $U_L$ .

[Setting method]

1) Run/stop

The starting and stopping control is done from the terminal block.

Title	Function	Adjustment range	Setting
$\overline{CND}$	Command mode selection	0: Terminal block 1: Panel keypad (including extension panel) 2: RS485 communication 3: CANopen communication 4: Communication option	0

2) Preset-speed frequency setting

a) Set the speed (frequency) of the number of steps necessary.

[Parameter setting]

Preset-speed 0

Title	Function	Adjustment range	Default setting
$SR0$	Preset-speed frequency 0	$L_L - U_L$ (Hz)	0.0
$FND$	Frequency setting mode selection 1	0-13 14: $SR0$	0

Frequency command set with  $SR0$  is valid when  $FND=14$  ( $SR0$ ).

( $SR0$  is valid even when the command mode selection is not  $\overline{CND}=0$ .)

Setting from speed 1 to speed 15

Title	Function	Adjustment range	Default setting
$SR1 - SR7$	Preset-speed frequency 1-7	$L_L - U_L$ (Hz)	0.0
$F287 - F294$	Preset-speed frequency 8-15	$L_L - U_L$ (Hz)	0.0

b) Speed (frequency) can be changed during operation.

Title	Function	Adjustment range	Setting
$F724$	Operation frequency setting target by setting dial	0: Panel frequency ( $F\overline{L}$ ) 1: Panel frequency ( $F\overline{L}$ ) + Preset speed frequency	1

When  $F724=1$ , speed (frequency) can be changed with the setting dial during operation. Set value of the Preset-speed frequency will change by pressing the center.

terminal	1	2	3	4	5	6	7	8	9	10	11	12	13	14	15	
S1	S1-CC	○	-	○	-	○	-	○	-	○	-	○	-	○	-	○
S2	S2-CC	-	○	○	-	-	○	○	-	-	○	○	-	-	○	○
S3	S3-CC	-	-	-	-	○	○	○	-	-	-	-	-	○	○	○
RES	RES-CC	-	-	-	-	-	-	-	-	○	○	○	○	○	○	○

★ Terminal functions are as follows.

Terminal S1..... Input terminal function selection 4A (S1)

$F \setminus I 4 = I 0$  (Preset-speed command 1: SS1)

Terminal S2..... Input terminal function selection 5 (S2)

$F \setminus I 5 = I 2$  (Preset-speed command 2: SS2)

Terminal S3..... Input terminal function selection 6 (S3)

$F \setminus I 6 = I 4$  (Preset-speed command 3: SS3)

Terminal RES..... Input terminal function selection 3A (RES)

$F \setminus I 3 = I 6$  (preset-speed command 4: SS4)

★ In the default settings, SS4 is not assigned. Assign SS4 to RES with input terminal function selection.

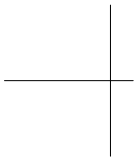

[ Example of a connection diagram ]  
(with sink logic settings)

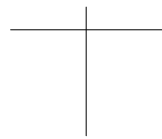
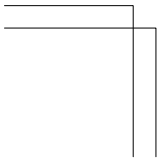
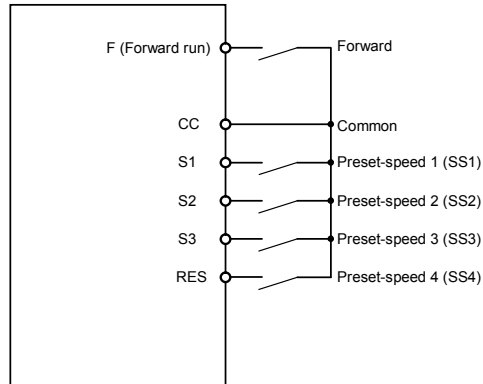



5

Frequency setting mode selection <i>F r 0 d</i>		5: UP/DOWN from external logic input 6: CANopen communication 7: Communication option 8: Terminal VIC 9, 10: - 11: Pulse train input 12, 13: - 14: <i>S r 0</i>	5: UP/DOWN from external logic input 6: CANopen communication 7: Communication option 8: Terminal VIC 9, 10: - 11: Pulse train input 12, 13: - 14: <i>S r 0</i>
Preset-speed command	Active	<b>Preset-speed command valid</b> Note)	
	Inactive	Command set with <i>F r 0 d</i> is valid	

**(The inverter doesn't accept Preset-speed command.)**

Note) The preset-speed command is always given priority when other speed commands are input at the same time.

An example of three-speed operation with the default settings is shown below.  
(Frequency settings are required for *S r 1* to *3*)

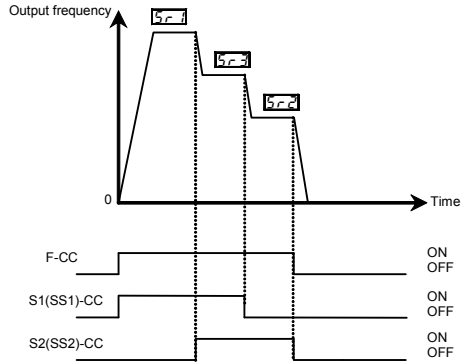

- Function

These parameters are used to switch between two frequency commands automatically or with input terminal signals.

### Parameter setting

Title	Function	Adjustment range	Default setting
<i>FNDd</i>	Frequency setting mode selection 1	0: Setting dial 1(save even if power is off) 1: Terminal VIA 2: Terminal VIB 3: Setting dial 2(press in center to save) 4: RS485 communication 5: UP/DOWN from external logic input 6: CANopen communication 7: Communication option 8: Terminal VIC	0
<i>F2D7</i>	Frequency setting mode selection 2	9, 10: - 11: Pulse train input 12, 13: - 14: <i>SRD</i>	1
<i>F2D0</i>	Frequency priority selection	0: <i>FNDd</i> (Switchable to <i>F2D7</i> by terminal input) 1: <i>FNDd</i> (Switchable to <i>F2D7</i> at 1.0 Hz or less of designated frequency)	0

#### 1) Switching with input terminal signals (Input terminal function 104/105: FCHG)

Frequency priority selection parameter *F2D0* = 0

Switch frequency command set with *FNDd* and *F2D7* by the input terminal signals.

Assign frequency setting mode forced switching function (input terminal function selection: 104) to an input terminal.

If an OFF command is entered to the input terminal block: The frequency command set with *FNDd*.

If an ON command is entered to the input terminal block: The frequency command set with *F2D7*.

Note) Input terminal function 105 is the inverse signal of the above.

5

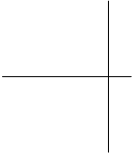

---

E-20

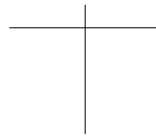
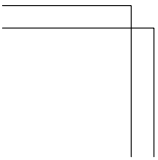

Mandatory action

- This could result in unexpected injury.
- Attach caution label about sudden restart after a momentary power failure on inverters, motors and equipment for prevention of accidents in advance.

• Function

The  $F301$  parameter detects the rotating speed and rotational direction of the motor during coasting at the event of momentary power failure, and then after power has been restored, restarts the motor smoothly (motor speed search function). This parameter also allows switching from commercial power operation to inverter operation without stopping the motor.

During operation, "r.r.y" is displayed.

[Parameter setting]

Title	Function	Adjustment range	Default setting
$F301$	Auto-restart control selection	0: Disabled 1: At auto-restart after momentary stop 2: At ST terminal off and on 3: 1 + 2 4: At start-up	0

\* If the motor is restarted in retry mode, this function will operate, regardless of the setting of this parameter.

1) Auto-restart after momentary power failure (Auto-restart function)

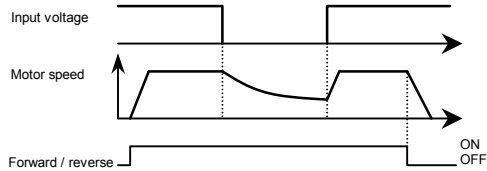

Setting  $F301$  to 1 or 3: This function operates after power has been restored following detection of an undervoltage by the main circuits and control power.

- ★ Setting  $F301$  to 2 or 3: This function operates after the ST-CC terminal connection has been opened first and then connected again.

Note 1: As the default setting for ST (Standby) is Always ON, change the following settings.

- $F10=1$  (no function)
- Assign 6: ST (Standby) to an open input terminal.

### 3) Motor speed search at starting

When  $F301$  is set to 4, a motor speed search is performed each time operation is started.

This function is useful especially when the motor is not operated by the inverter but by the external factor.

#### Warning!!

- At restart, it takes about 1 second for the inverter to check the number of revolutions of the motor. For this reason, the start-up takes more time than usual.
- Use this function when operating a system with one motor connected to one inverter. This function may not operate properly in a system configuration when multiple motors are connected to one inverter.
- In case of using this function, do not set the output phase failure detection selection ( $F505=1, 2, 4$ ).

#### Application to a crane or hoist

The crane or hoist may have its load to be moved downward during the above waiting time.

To apply the inverter to such machines, therefore, set the auto-restart control mode selection parameter to " $F301=0$ " (Disabled), Do not use the retry function, either.

Note 2: It is not malfunction that abnormal noise might be heard from the motor during the motor speed search at the auto-restart.

5

These parameters are used to change the unit of monitor display.  
% ⇔ A (ampere)/V (volt)

Current 100% = Rated current of inverter  
Input/output voltage 100% = 200Vac (240V class), 400Vac (500V class)

### ■ Example of setting

During the operation of the VFS15-2015PM-W (rated current: 8.0A) at the rated load (100% load), units are displayed as follows:

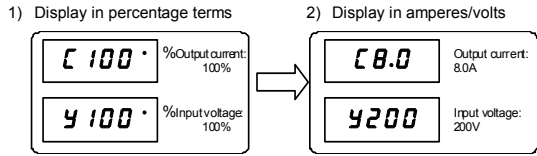

[Parameter setting]

Title	Function	Adjustment range	Default setting
<i>F 70</i>	Current/voltage unit selection	0: % 1: A (ampere) / V (volt)	0

\* The *F 70* converts the following parameter settings:

- A display : Current monitor display: Load current, torque current  
Motor electronic-thermal protection level 1 & 2    *t H r , F 173*  
DC braking current    *F 25*  
Stall prevention level 1 & 2                                *F 60* , *F 185*  
Small current detection current                            *F 6* ! !

- V display : Input voltage, output voltage

Note) Base frequency voltage 1 & 2 (*u L u , F 17* ! ) always displayed in the unit of V.

- Function

The frequency or any other item displayed on the monitor can be converted into the rotational speed of the motor or load device. The unit of the amount of processing or that of feedback can be changed at PID control.

The value obtained by multiplying the displayed frequency by the  $F702$ -set value will be displayed as follows:

$$\text{Value displayed} = \text{Monitor-displayed or parameter-set frequency} \times [F702]$$

- 1) Displaying the motor speed

To switch the display mode from 60Hz (default setting) to  $1800\text{min}^{-1}$  (the rotating speed of the 4P motor)

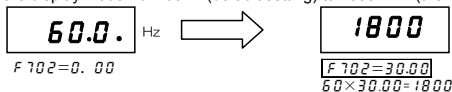

- 2) Displaying the speed of the loading unit

To switch the display mode from 60Hz (default setting) to  $6\text{m}/\text{min}^{-1}$  (the speed of the conveyor)

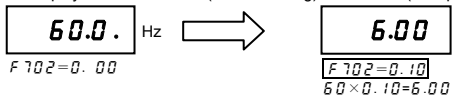

Note: This parameter displays the inverter output frequency as the value obtained by multiplying it by a positive number. This does not mean that the actual motor speed or line speed are indicated with accuracy.

[Parameter setting]

Title	Function	Adjustment range	Default setting
$F702$	Frequency free unit display magnification	0.00: Disabled (display of frequency) 0.01-200.0 (times)	0.00
$F703$	Frequency free unit coverage selection	0: All frequencies display 1: PID frequencies display	0
$F705$	Inclination characteristic of free unit display	0: Negative inclination (downward slope) 1: Positive inclination (upward slope)	1
$F706$	Free unit display bias	0.00- $FH$ (Hz)	0.00

F213, F217, F219  
 F240, F241, F242, F250, F260, F265,  
 F267, F268, F270 to F275,  
 F287~F294, F330, F331, F346, F350,  
 F367, F368, F383,  
 F390 to F393, F505, F513, F649, F812,  
 F814, A923 to A927

In case of  $F703=1$

- Free unit PID control-related parameters  $FP1d, F367, F368$

Note) The unit of the Base frequency 1 and 2 are always Hz.

■ An example of setting when  $F704$  is 80 and  $F702$  is 10.00

$F705=1, F706=0.00$

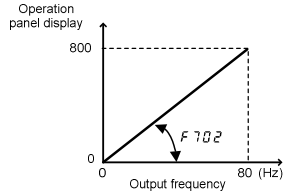

$F705=1, F706=20.00$

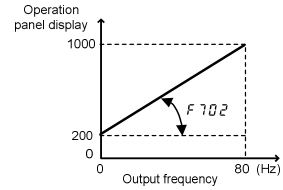

$F705=0, F706=80.00$

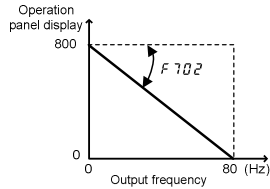













<i>AVL</i>	Overload characteristic selection	5.6, 6.18
<i>F75L</i>	Meter selection	
<i>FN</i>	Meter adjustment gain	5.1
<i>RCC</i>	Acceleration time 1	
<i>dEC</i>	Deceleration time 1	5.2
<i>FH</i>	Maximum frequency	
<i>UL</i>	Upper limit frequency	5.3
<i>LL</i>	Lower limit frequency	
<i>uL</i>	Base frequency 1	
<i>uLv</i>	Base frequency voltage 1	5.4
<i>EHr</i>	Motor electronic-thermal protection level 1	
<i>ELN</i>	Electronic-thermal protection characteristic selection	5.5
<i>5r0-5r7</i>	Preset-speed frequency 0-7	
<i>FP1d</i>	Process input value of PID control	5.6
<i>tYP</i>	Default setting	4.3.2
<i>SEt</i>	Checking the region setting	4.4
<i>PSEL</i>	EASY key mode selection	4.5
<i>GRU</i>	Automatic edit function	4.3.1
<i>F200</i>	Frequency priority selection	
<i>F207</i>	Frequency setting mode selection 2	5.8
<i>F287-F294</i>	Preset-speed frequency 8-15	
<i>F301</i>	Auto-restart control selection	5.7
<i>F519</i>	Setting of acceleration/deceleration time unit	5.9
<i>F607</i>	Motor 150% overload detection time	
<i>F631</i>	Inverter overload detection method	
<i>F632</i>	Electronic-thermal memory	5.9
<i>F657</i>	Overload alarm level	
<i>F701</i>	Current/voltage unit selection	5.10.1
<i>F702</i>	Frequency free unit display magnification	
<i>F703</i>	Frequency free unit coverage selection	
<i>F705</i>	Inclination characteristic of free unit display	5.10.2
<i>F706</i>	Free unit display bias	
<i>F724</i>	Operation frequency setting target by setting dial	5.7
<i>F750</i>	EASY key function selection	
<i>F751-F782</i>	Easy setting mode parameter 1-32	4.5

default setting and displays them in the *FRQ*. Parameter setting can also be changed within this group *RUH*.

### How to use the history function

Operation panel action	LED display	Operation
	0.0	Displays the output frequency (operation stopped). (When standard monitor display selection <i>F 7 1 0=0</i> (output frequency))
	<i>RUH</i>	The first basic parameter " <i>RUH</i> " (history function) is displayed.
	<i>ACC</i>	The parameter that was set or changed last is displayed.
	5.0	Press the center of the setting dial to display the set value.
	5.0	Turn the setting dial to change the set value.
	5.0 ↔ <i>ACC</i>	Press the center of the setting dial to save the changed value. The parameter name and the programmed value will flash on and off alternately.
	****	Turn the dial as described above to search for and display changed parameters to check and change the settings.
	<i>HERd</i> ( <i>End</i> )	<i>HERd</i> : First historic record <i>End</i> : Last historic record
  	Parameter display ↓ <i>RUH</i> ↓ <i>F r - F</i> ↓ 0.0	Press the MODE key to return to the parameter setting mode " <i>RUH</i> ." After that you can press the MODE key to return to the status monitor mode or the standard monitor mode (display of output frequency).

6

## 6.1.2 Application easy setting (AUR)

**AUR** : Application easy setting

Application easy setting (AUR):





Parameters necessary to your machine can be set easily using the application easy setting.

The parameters necessary to the machine is set to easy setting mode parameters 1-32 (F 75 1-F 782). Set the parameters using the easy setting mode. (Refer to section 4.2.)

[Parameter setting]

Title	Function	Adjustment range	Default setting
AUR	Application easy setting	0:- 1: Initial easy setting 2: Conveyor 3: Material handling 4: Hoisting 5: Fan 6: Pump 7: Compressor	0

# 6

	<i>RUR</i>	Turn the setting dial to the right to change the parameter to <i>RUR</i> .
	0	Set values are displayed by pressing the center of the setting dial.
	2	Turn the setting dial to the right to select 1 or 2.
	2 ⇌ <i>RUR</i>	Press the center of the setting dial to save the changed set value. <i>RUR</i> and the set value are displayed alternately.

- 2) The parameters necessary to the machine are set to easy setting mode parameter 1-32. (Refer to the chart below)
- 3) Set the parameters using easy setting mode. Refer to section 4.2 for easy setting mode.

Table of parameters that can be set using *RUR*

<i>RUR</i>	1: Initial easy setting	2: Conveyor	3: Material handling	4: Hoisting	5: Fan	6: Pump	7: Compressor
<i>F751</i>	<i>C00d</i>	<i>C00d</i>	<i>C00d</i>	<i>C00d</i>	<i>C00d</i>	<i>C00d</i>	<i>C00d</i>
<i>F752</i>	<i>F00d</i>	<i>F00d</i>	<i>F00d</i>	<i>F00d</i>	<i>F00d</i>	<i>F00d</i>	<i>F00d</i>
<i>F753</i>	<i>RCC</i>	<i>RCC</i>	<i>RCC</i>	<i>RCC</i>	<i>RCC</i>	<i>RCC</i>	<i>RCC</i>
<i>F754</i>	<i>dEC</i>	<i>dEC</i>	<i>dEC</i>	<i>dEC</i>	<i>dEC</i>	<i>dEC</i>	<i>dEC</i>
<i>F755</i>	<i>UL</i>	<i>UL</i>	<i>UL</i>	<i>UL</i>	<i>FH</i>	<i>FH</i>	<i>FH</i>
<i>F756</i>	<i>LL</i>	<i>LL</i>	<i>LL</i>	<i>LL</i>	<i>UL</i>	<i>UL</i>	<i>UL</i>
<i>F757</i>	<i>tHr</i>	<i>tHr</i>	<i>tHr</i>	<i>tHr</i>	<i>LL</i>	<i>LL</i>	<i>LL</i>
<i>F758</i>	<i>FN</i>	<i>FN</i>	<i>FN</i>	<i>FN</i>	<i>tHr</i>	<i>tHr</i>	<i>tHr</i>
<i>F759</i>	-	<i>Pt</i>	<i>Pt</i>	<i>Pt</i>	<i>FN</i>	<i>FN</i>	<i>FN</i>
<i>F760</i>	-	<i>QLn</i>	<i>QLn</i>	<i>QLn</i>	<i>Pt</i>	<i>Pt</i>	<i>Pt</i>
<i>F761</i>	-	<i>Sr1</i>	<i>Sr1</i>	<i>F304</i>	<i>F201</i>	<i>F201</i>	<i>F216</i>
<i>F762</i>	-	<i>Sr2</i>	<i>Sr2</i>	<i>F308</i>	<i>F202</i>	<i>F202</i>	<i>F217</i>
<i>F763</i>	-	<i>Sr3</i>	<i>Sr3</i>	<i>F309</i>	<i>F203</i>	<i>F203</i>	<i>F218</i>
<i>F764</i>	-	<i>Sr4</i>	<i>Sr4</i>	<i>F328</i>	<i>F204</i>	<i>F204</i>	<i>F219</i>
<i>F765</i>	-	<i>Sr5</i>	<i>Sr5</i>	<i>F329</i>	<i>F207</i>	<i>F207</i>	<i>FP1d</i>
<i>F766</i>	-	<i>Sr6</i>	<i>Sr6</i>	<i>F330</i>	<i>F216</i>	<i>F216</i>	<i>F359</i>
<i>F767</i>	-	<i>Sr7</i>	<i>Sr7</i>	<i>F331</i>	<i>F217</i>	<i>F217</i>	<i>F360</i>

F776	-	F252	F502	F400	F668	F612	F373
F777	-	F304	F506	F405	-	F633	F380
F778	-	F308	F507	F415	-	F667	F389
F779	-	F309	F701	F417	-	F668	F391
F780	-	F701	-	F648	-	-	F621
F781	F701	F702	-	F701	-	-	-
F782	P5EL	P5EL	P5EL	P5EL	P5EL	P5EL	P5EL

### 6.1.3 Setting a parameter using the guidance function (*RUF*)

**RUF** : Guidance function

Guidance function (*RUF*):











The guidance function refers to the special function of calling up only functions necessary to set up the inverter in response to the user's needs. When a purpose-specific guidance is selected, a group of parameters needed for the specified application (function) is formed and the inverter is switched automatically to the mode of setting the group of parameters selected. You can set up the inverter easily by simply setting the parameters in the group one after another. The guidance function (*RUF*) provides five purpose-specific guidance.

[Parameter setting]

Title	Function	Adjustment range	Default setting
<i>RUF</i>	Guidance function	0:- 1: - Note 1 2: Preset speed guidance 3: - Note 1 4: Motor 1&2 switching operation guidance 5: Motor constant setting guidance 6: - Note 1	0

Note1) 1, 3, and 6 are for manufacturer's settings. Do not change the settings.

6

	<i>RUH</i>	The first basic parameter "History ( <i>RUH</i> )" is displayed.
	<i>RUF</i>	Turn the setting dial to select the guidance function ( <i>RUF</i> ).
	<i>0</i>	Press the center of the setting dial to display <i>0</i> .
	<i>2</i>	Turn the setting dial to change to the setting value "2".
	<i>End</i>	Press the center of the setting dial to display the purpose-specific guidance parameter group (refer to following table).
	****	After moving to the purpose-specific guidance parameter group, use the setting dial to change the parameters.
	<i>End</i>	<i>End</i> is displayed on completion of the setting of the guidance parameter group.
  	Display of parameter ↓ <i>RUF</i> ↓ <i>F r - F</i> ↓ <i>0.0</i>	Press the MODE key to exit the guidance parameter group. Thereafter, return to the default monitoring mode (display of output frequency) by pressing the MODE key.

If there is anything you do not understand during this operation, press the MODE key several times to start over from the step of *RUH* display.

*HERd* or *ENd* is affixed respectively to the first or last parameter in each guidance wizard parameter group.

F113	ub
F114	F415
F115	LKr
F116	F601
Sr1	RCC
Sr2	dEC
Sr3	F170
Sr4	F171
Sr5	F172
Sr6	F173
Sr7	F185
F287	F500
F288	F501
F289	
F290	
F291	
F292	
F293	
F294	

## 6.1.4 Automatically adjusting acceleration/deceleration time

**AW1**: Automatic acceleration/deceleration

- Function

This automatically adjusts acceleration and deceleration time in line with load torque and the moment of inertia.

Refer to section 5.3 for setting acceleration/ deceleration time manually.

**AW1** = 1

\* Adjusts the acceleration/deceleration time automatically within the range of 1/8 to 8 times as long as the time set with the *RCC* or *dEC*, depending on the current rating of the inverter.

**AW1** = 2

\* Automatically adjusts speed during acceleration only. During deceleration, speed is not adjusted automatically but reduced at the rate set with *dEC*.

Set  $R U I$  (automatic acceleration/deceleration) to  $1$  or  $2$

[Parameter setting]

Title	Function	Adjustment range	Default setting
$R U I$	Automatic acceleration/deceleration	0: Disabled (manual setting) 1: Automatic 2: Automatic (only at acceleration)	0

★ When automatically setting acceleration/deceleration time, always change the acceleration/deceleration time so that it conforms to the load. For inverters that require a fixed acceleration/deceleration time, use the manual settings ( $R L L$ ,  $d E L$ ).





★ Setting acceleration/deceleration time ( $R L L$ ,  $d E L$ ) in conformance with mean load allows optimum setting that conforms to further changes in load.

★ Use this parameter after actually connecting the motor.

★ When the inverter is used with a load that fluctuates considerably, it may fail to adjust the acceleration or deceleration time in time, and therefore may be tripped.

★ Do not set  $R U I = 1$  when using a dynamic braking resistor (optional).

[Methods of setting automatic acceleration/deceleration]

Operation panel action	LED display	Operation
	$0.0$	Displays the output frequency. (When standard monitor display selection $F 7 I Q$ is set to $Q$ [output frequency])
	$R U H$	The first basic parameter "R U H" (history function) is displayed.
	$R U I$	Turn the setting dial to the right to change the parameter to $R U I$ .
	$0$	Set values are displayed by pressing the center of the setting dial.
	$1$	Turn the setting dial to the right to switch $1$ or $2$ .
	$1 \leftrightarrow R U I$	Press the center of the setting dial to save the changed set value. $R U I$ and the set value are displayed alternately.

★ Assigning the fast stop command 2 (function number 122/ 123) to any logic input terminal, it can be changed automatic deceleration by compulsion.

6



[Parameter setting]

Title	Function	Adjustment range	Default setting
<i>RU2</i>	Torque boost setting macro function	0: - 1: Automatic torque boost + auto-tuning 2: Vector control + auto-tuning 3: Energy saving + auto-tuning	0

Note1) Parameter displays on the right always return to 0 after setting. The previous setting is displayed on the left.

Ex.

Note2) Auto-tuning is performed at the start of the motor.

Caution:

When the torque boost setting macro function *RU2* is set, look at the motor's name plate and set the following parameters.

- uL* : Base frequency 1 (rated frequency)
- uLv* : Base frequency voltage 1 (rated voltage)
- F405* : Motor rated capacity
- F415* : Motor rated current
- F417* : Motor rated speed

Set the other motor constants as necessary.

### 1) Increasing torque automatically according to the load

*RU2* is set to 1 (Automatic torque boost + auto-tuning)

When torque boost setting macro function control *RU2* is set to 1 (automatic torque boost + auto-tuning), the inverter keeps track of the load current in any speed range and automatically adjusts the output voltage to ensure enough torque and stable operation.

Note 1: The same characteristic can be obtained by setting the V/F control mode selection parameter *Pt* to 2 (automatic torque boost control) and the auto-tuning parameter *F400* to 2 (auto-tuning).

⇒ Refer to section 6.25

Note 2: Setting *RU2* to 1 automatically programs *Pt* to 2.

Note 3: The same characteristic can be obtained by setting the V/F control mode selection parameter  $P\bar{L}$  to 3 (vector control) and the auto-tuning parameter  $F400$  to 2 (auto-tuning).

⇒ Refer to section 6. 25

Note 4: Setting  $RU2$  to 2 automatically programs  $P\bar{L}$  to 3.

### 3) Energy-saving operation

$RU2$  is set to 3 (Energy saving + auto-tuning)





When torque boost setting macro function control  $RU2$  is set to 3 (energy saving + auto-tuning), the inverter always passes a current appropriate to the load for energy saving.

Note 5: The same characteristic can be obtained by setting the V/F control mode selection parameter  $P\bar{L}$  to 4 (automatic energy saving) and the auto-tuning parameter  $F400$  to 2 (auto-tuning).

⇒ Refer to section 6. 25

Note 6: Setting  $RU2$  to 3 automatically programs  $P\bar{L}$  to 4.

[Example of parameter setting]

Operation panel action	LED display	Operation
	0. 0	Displays the output frequency. (Perform during operation stopped.) (When standard monitor display selection $F710$ is set to 0 [output frequency])
	$RUH$	The first basic parameter " $RUH$ " (history function) is displayed.
	$RU2$	Turn the setting dial to the right to change the parameter to $RU2$ (torque boost setting macro function).
	0 0	Set values are displayed by pressing the center of the setting dial.
	0 3	Turn the setting dial to the right to change the parameter to 3 (energy saving + auto-tuning). (Right side is the setting value, left side is the history of the previous setting.)
	0 3 ⇄ $RU2$	Press the center of the setting dial to save the changed parameter. $RU2$ and the parameter are displayed alternately.

(F400) together. That is why all parameters related to change automatically when  $RU2$  is changed.

			Automatically programmed parameters		
$RU2$		$Pt$		$F400$	
$0$	Displays $0$ after resetting	-	Check the programmed value of $Pt$ .	-	
$1$	Automatic torque boost + auto-tuning	$2$	Automatic torque boost control	$2$	Auto-tuning executed (after execution: 0)
$2$	Vector control + auto-tuning	$3$	Vector control	$2$	Auto-tuning executed (after execution: 0)
$3$	Energy saving + auto-tuning	$4$	Energy-saving	$2$	Auto-tuning executed (after execution: 0)

#### 4) Increasing torque manually (V/F constant control)

This is the setting of constant torque characteristics that are suited for such things as conveyors. It can also be used to manually increase starting torque.

If V/F constant control is programmed after changing  $RU2$ .

Set V/F control mode selection  $Pt = 0$  (V/F constant).

⇒ Refer to section 6.3

Note 7: To further increase torque, increase the torque boost value  $1ub$ .

How to set the torque boost value  $1ub$

⇒ Refer to section 6.4

Note 8: V/F control selection  $Pt = 1$  (variable torque) is an effective setting for load such as fans and pumps.

⇒ Refer to section 6.3

These parameters are used to specify which input device (panel keypad, terminal block, or communication) takes priority in entering an operation stop command or frequency setting mode (terminal VIA/VIB/VIC, setting dial, communication, or UP/DOWN from external logic).

<Command mode selection>

[Parameter setting]

Title	Function	Adjustment range	Default setting
$\zeta \eta \theta d$	Command mode selection	0: Terminal block 1: Panel keypad (including extension panel) 2: RS485 communication 3: CANopen communication 4: Communication option	1

[Programmed value]

- 0: Terminal block operation ON and OFF of an external signal run and stop operation.
- 1: Panel keypad operation Press the **RUN** and **STOP** keys on the panel keypad to run and stop. Operation can also be done from the extension panel.
- 2: RS485 communication Run/stop operations by RS485 communication from an external device. ⇒ Refer to section 6.33.
- 3: CANopen communication Run/stop operations by CANopen communication from an external device. ⇒ Refer to "CANopen communication Instruction Manual E6581911".
- 4: Communication option Run/stop operations by commands from a communication option. ⇒ Refer to each Instruction Manual of option.

\* Operation command selected by  $\zeta \eta \theta d$  and the operation commands from the terminal block can be switched alternately with ON/ OFF of input terminal. (input terminal function number 108, 109) See the table of input terminal function selection in section 11.6.

\* When priority is given to commands from a linked computer or terminal block, they have priority over the setting of  $\zeta \eta \theta d$ .

		7: Communication option 8: Terminal VIC 9, 10: - 11: Pulse train input 12, 13: - 14: <i>5 r 0</i>	
--	--	--	--

[Programmed value]

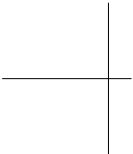
- 
- 0:** **Setting dial 1** Frequencies are set by rotating the setting dial on the inverter. Like the position of notches in a volume knob, the frequency setting value at the position of the notch is saved.  
⇒ Refer to section 3.2.2
- 1:** **Terminal VIA** A frequency command is set by means of external analog signals.  
(VIA terminal: 0 -10Vdc)  
⇒ Refer to section 3.2.2 and 7.3
- 2:** **Terminal VIB** A frequency command is set by means of external analog signals.  
(VIB terminal: 0 - +10Vdc or -10 - +10Vdc)  
⇒ Refer to section 3.2.2 and 7.3
- 3:** **Setting dial 2** Frequencies are set by rotating the setting dial on the inverter. Press the center of the setting dial to save the frequency setting value.  
⇒ Refer to section 3.2.2
- 4:** **RS485 communication** Frequencies are set by RS485 communication from an external device.  
⇒ Refer to section 6.33
- 5:** **UP/DOWN from external logic input** Frequencies are set by up/down commands from a terminal.  
⇒ Refer to section 6.6.3
- 6:** **CANopen communication** Frequencies are set by CANopen communication from an external device.  
⇒ Refer to "CANopen communication Instruction Manual E6581911".
- 7:** **Communication option** Frequencies are set by commands from a communication option.  
⇒ Refer to each Instruction Manual of option.

6

- ★ The control input terminal in which the following functions are set is always valid regardless of the setting of  $\mathcal{C}n0d$  and  $Fn0d$ .
  - Reset (valid only for tripping)
  - Standby
  - External input tripping stop command
  - Coast stop command terminal
- ★ To make changes in the command mode selection  $\mathcal{C}n0d$  and the frequency setting mode selection 1  $Fn0d$ , first stop the inverter temporarily.  
(Can be changed while in operation when  $F735$  is set to 0.)
- ★ Priority commands from communications or terminal blocks are given priority over  $Fn0d$ .

■ Preset-speed operation

$\mathcal{C}n0d$ : Set to 0 (Terminal block operation)

$Fn0d$ : Valid in all setting values.

■ Input terminal settings

Assign the following functions to the input terminal to allow switching of the frequency command by turning the terminal ON/OFF.

Input terminal function		ON	OFF
48	Forced local from communication	Enabled during communication Local (Setting of $\mathcal{C}n0d$ , $Fn0d$ )	Communication
106	Frequency setting mode terminal block	Terminal block (VIA) enabled	setting of $Fn0d$

Each of the following numbers (49, 107) are reverse signals.

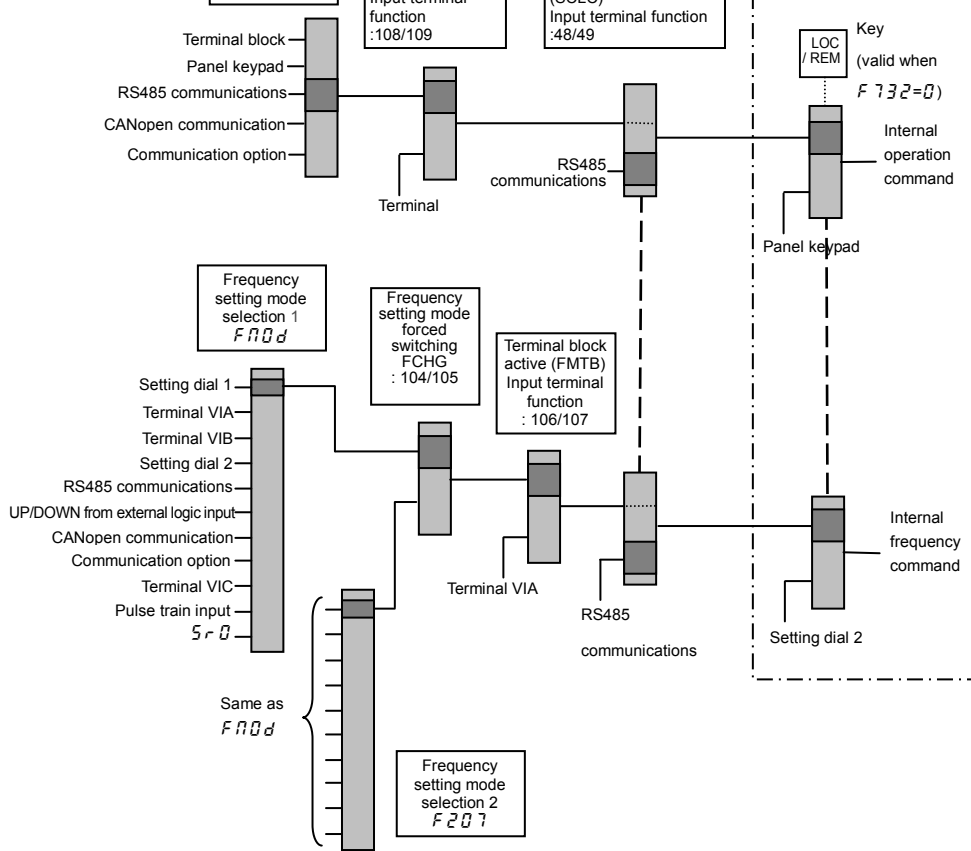

valid when  $L1700$  (command mode) is set to 1 (operation panel).

[Parameter setting]

Title	Function	Adjustment range	Default setting
$F_r$	Forward/reverse run selection (Panel keypad)	0: Forward run 1: Reverse run 2: Forward run (F/R switching on extension panel) 3: Reverse run (F/R switching on extension panel)	0

6

- ★ Using extension panel RKP007Z (option) : When  $F_r$  is set to 2 and the standard monitor is displayed, pressing the FWD/REV key changes the direction of rotation from forward to reverse after displaying the message  $F_r - r$ .  
Pressing the FWD/REV key again changes the direction of rotation from reverse to forward after displaying the message  $F_r - F$ .
- ★ Using extension panel RKP002Z (option) : When  $F_r$  is set to 2 and the standard monitor is displayed, pressing the DOWN key while pressing the ENT key changes the direction of rotation from forward to reverse after displaying the message  $F_r - r$ .  
Pressing the UP key while pressing the ENT key again changes the direction of rotation from reverse to forward after displaying the message  $F_r - F$ .
- ★ Check the direction of rotation on the status monitor. Refer to section 8.1 for details about monitor.  
 $F_r - F$  : Forward run  
 $F_r - r$  : Reverse run
- ★ When the F and R terminals are used for switching between forward and reverse rotation from the terminal block, the  $F_r$  forward/reverse run selection parameter is rendered invalid.  
Short across the F-CC (Sink logic) or P24-F (Source logic) terminals: forward rotation  
Short across the R-CC (Sink logic) or P24-R (Source logic) terminals: reverse rotation
- ★ You can use the parameter  $F105$  to select deceleration stop or reverse run for the action when both forward and reverse run signals from terminal block are ON simultaneously. The motor will decelerate to stop when the inverter was factory-configured by default.



- Variable torque
- Automatic torque boost control \*1
- Vector control \*1
- Energy saving \*1
- Dynamic energy-saving (For fan and pump)
- PM motor control
- V/F 5-point setting

\*1 Parameter setting macro torque boost:  $P_{U2}$  parameter can automatically set this parameter and auto-tuning at a time. (Refer to section 5.4)

[Parameter setting]

Title	Function	Adjustment range	Default setting
$P_{L}$	V/F control mode selection	0: V/F constant 1: Variable torque 2: Automatic torque boost control 3: Vector control 4: Energy-saving 5: Dynamic energy-saving (For fan and pump) 6: PM motor control 7: V/F 5-point setting 8: - *3	*2





\*2: Default setting values vary depending on the setup menu setting. Refer to section 11.5.

\*3: 8 is manufacturer setting parameter. Do not change the value of this parameter.

Note:  $P_{L}$  (V/F control mode selection) is valid only for the first motor.

Changes to "V/F constant control" when switching to the second motor, regardless of the  $P_{L}$  setting.

6

MODE	$P U H$	The first basic parameter " $P U H$ " (history function) is displayed.
	$P \underline{L}$	Rotate the setting dial to the right, and change the parameter to $P \underline{L}$ (V/F control mode selection).
	$\underline{2}$	Set values are displayed by pressing the center of the setting dial.
	$\underline{3}$	Rotate the setting dial to the right, and change the parameter to $\underline{3}$ (vector control).
	$\underline{3} \leftrightarrow P \underline{L}$	Press the center of the setting dial to save the changed set value. $P \underline{L}$ and the set value " $\underline{3}$ " are displayed alternately.

Caution:

When the V/F control mode selection  $P \underline{L}$  is set to  $\underline{2}$ : Automatic torque boost control,  $\underline{3}$ : Vector control,  $\underline{4}$ : Energy-saving,  $\underline{5}$ : Dynamic energy-saving, or  $\underline{6}$ : PM motor control, be sure to set the following parameters according to the motor's name plate.

- $\underline{u} \underline{L}$  : Base frequency 1 (rated frequency)
- $\underline{u} \underline{L} \underline{v}$  : Base frequency voltage 1 (rated voltage)
- $F \underline{4} \underline{Q} \underline{5}$  : Motor rated capacity
- $F \underline{4} \underline{I} \underline{5}$  : Motor rated current
- $F \underline{4} \underline{I} \underline{7}$  : Motor rated speed

Set the other motor constants as necessary

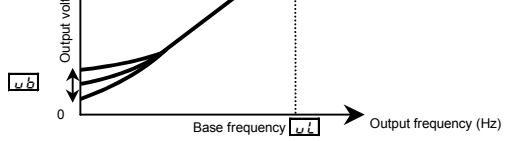

\* To increase the torque further, increase the setting value of the manual torque boost value 1 ( $u b$ ).  
 ⇒ Refer to section 5.12 for details.

## 2) Setting for fans and pumps

Setting of V/F control mode selection  $P \xi$  to  $f$  (variable torque)

This is appropriate for load characteristics of such things as fans, pumps and blowers in which the torque is proportional to the square of load rotation speed. in relation to is.

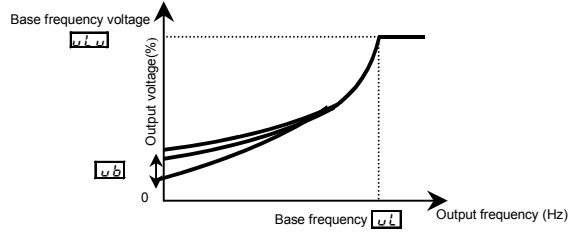

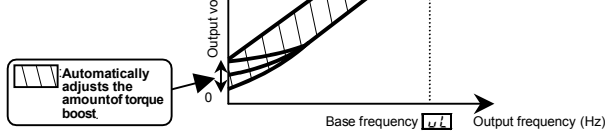

Note: This control system can oscillate and destabilize runs depending on the load. In this case, set V/F mode selection  $P\ 1 = 0$  (V/F constant) and increase manual torque boost  $u\ b$ .

6

★ Motor constant must be set

If the motor you are using is a 4P Toshiba standard motor which has the same capacity as the inverter, there is basically no need to set the motor constant. There are three setting methods as mentioned below. In any method, set the following parameters according to the motor's name plate.

$u\ 1$  (Base frequency 1),  $u\ 1\ u$  (Base frequency voltage 1),  $F\ 4\ 0\ 5$  (Motor rated capacity),  $F\ 4\ 1\ 5$  (Motor rated current),  $F\ 4\ 1\ 7$  (Motor rated speed)

1) Simultaneous setting of auto torque boost and auto-tuning ( $F\ 4\ 0\ 0 = 2$ )

Set the basic parameter  $P\ 1\ 2$  (Torque boost setting macro function) to  $1$ .

⇒ Refer to section 5.5 for details.

2) Automatic setting

Set the extended parameter  $F\ 4\ 0\ 0$  (auto-tuning) to  $5$ . ⇒ Refer to section 6.22 selection 2 for details.

3) Manual setting

Set each motor constant. ⇒ Refer to section 6.22 selection 4 for details.

4) Vector control - increasing starting torque and achieving high-precision operation.

Setting of V/F control mode selection  $P\ 1$  to  $3$  (Vector control)

Using sensorless vector control will provide the highest torque at the low speed ranges.

(1) Provides large starting torque.

(2) Effective when stable operation is required to move smoothly up from the low speeds.

(3) Effective in elimination of load fluctuations caused by motor slippage.

★ Motor constant must be set

If the motor you are using is a 4P Toshiba standard motor which has the same capacity as the inverter, there is basically no need to set the motor constant. There are three setting methods as mentioned below. In any method, set the following parameters according to the motor's name plate.

$u\ 1$  (Base frequency 1),  $u\ 1\ u$  (Base frequency voltage 1),  $F\ 4\ 0\ 5$  (Motor rated capacity),  $F\ 4\ 1\ 5$  (Motor rated current),  $F\ 4\ 1\ 7$  (Motor rated speed)

Setting of V/F control mode selection  $P_{\text{L}}$  to 4 (Energy-saving)

Energy can be saved in all speed areas by detecting load current and flowing the optimum current that fits the load.

If the motor you are using is a 4P Toshiba standard motor which has the same capacity as the inverter, there is basically no need to set the motor constant. There are three setting methods as mentioned below. In any method, set the following parameters according to the motor's name plate.

$\omega_{\text{L}}$  (Base frequency 1),  $\omega_{\text{L}} \omega$  (Base frequency voltage 1),  $F_{\text{4}} \text{C} \text{S}$  (Motor rated capacity),  $F_{\text{4}} \text{I} \text{S}$  (Motor rated current),  $F_{\text{4}} \text{I} \text{?}$  (Motor rated speed)

1) Simultaneous setting of energy-saving and auto-tuning ( $F_{\text{4}} \text{C} \text{S} = 2$ )

Set the basic parameter  $R_{\text{U}} \text{?}$  (Torque boost setting macro function) to 3

⇒ Refer to section 5.5 for details.

2) Automatic setting

Set the extended parameter  $F_{\text{4}} \text{C} \text{S}$  (auto-tuning) to 5. ⇒ Refer to section 6.22 selection 2 for details.

3) Manual setting

Set each motor constant. ⇒ Refer to section 6. 22 selection 4 for details.

## 6) Achieving further energy savings

Setting of V/F control mode selection  $P_{\text{L}}$  to 5 (Dynamic energy-saving)

More substantial energy savings than those provided by setting  $P_{\text{L}}$  to 4 can be achieved in any speed range by keeping track of the load current and passing a current appropriate to the load. The inverter cannot respond to rapid load fluctuations, so that this feature should be used only for loads, such as fans and pumps, that are free of violent load fluctuations.

### ★ Motor constant must be set

If the motor you are using is a 4P Toshiba standard motor which has the same capacity as the inverter, there is basically no need to set the motor constant. There are two setting methods as mentioned below. In any method, set the following parameters according to the motor's name plate.

$\omega_{\text{L}}$  (Base frequency 1),  $\omega_{\text{L}} \omega$  (Base frequency voltage 1),  $F_{\text{4}} \text{C} \text{S}$  (Motor rated capacity),  $F_{\text{4}} \text{I} \text{S}$  (Motor rated current),  $F_{\text{4}} \text{I} \text{?}$  (Motor rated speed)

1) Automatic setting

Set the extended parameter  $F_{\text{4}} \text{C} \text{S}$  (auto-tuning) to 5. ⇒ Refer to section 6.22 selection 2 for details.

2) Manual setting

Set each motor constant. ⇒ Refer to section 6.22 selection 4 for details.

In this mode, the base frequency and the base frequency voltage for the V/f control need to be set to operate the motor while switching a maximum of 5 different V/f characteristics.

[Parameter setting]

Title	Function	Adjustment range	Default setting
F 190	V/f 5-point setting VF1 frequency	0.0~F H (Hz)	0.0
F 191	V/f 5-point setting VF1 voltage	0.0~125.0 (%) *	0.0
F 192	V/f 5-point setting VF2 frequency	0.0~F H (Hz)	0.0
F 193	V/f 5-point setting VF2 voltage	0.0~125.0 (%) *	0.0
F 194	V/f 5-point setting VF3 frequency	0.0~F H (Hz)	0.0
F 195	V/f 5-point setting VF3 voltage	0.0~125.0 (%) *	0.0
F 196	V/f 5-point setting VF4 frequency	0.0~F H Hz	0.0
F 197	V/f 5-point setting VF4 voltage	0.0~125.0 (%) *	0.0
F 198	V/f 5-point setting VF5 frequency	0.0~F H (Hz)	0.0
F 199	V/f 5-point setting VF5 voltage	0.0~125.0 (%) *	0.0

\* 100% value is 200V for 240V class, and 400V for 500V class.

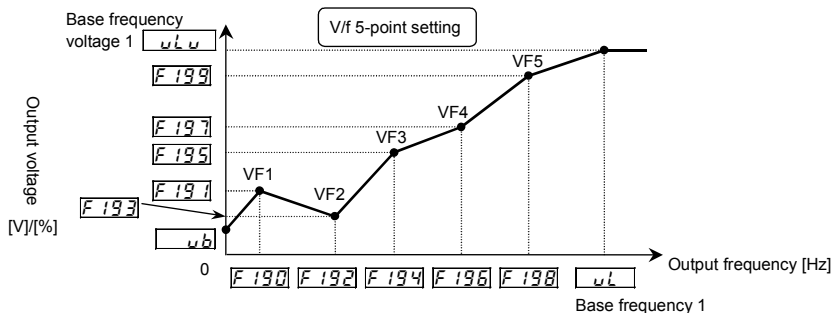

Note 1: Restrict the value of torque to boost ( $\omega b$ ) to 3% or so. Boosting the torque too much may impair the linearity between points.

Note 2: Please note if the inclination of each V/f is too high (exceeding 8.25%/Hz), R-02 (Points setting alarm 2) will occur.

### 9) Cautions for vector control

- 6) Always operate the motor in combination of one motor for one inverter. Sensorless vector control cannot be used when one inverter is operated with more than one motor.  
When using a combination of several motors, set the V/F constant ( $P_{L} = 0$ ).
- 7) The maximum length of wires between the inverter and motor is 30 meters. If the wires are longer than 30 meters, set standard auto-tuning with the wires connected to improve low-speed torque during sensorless vector control.  
However the effects of voltage drop cause motor-generated torque in the vicinity of rated frequency to be somewhat lower.
- 8) When a reactor is connected between the inverter and a motor, the motor's generated torque may fall.  
Setting auto-tuning may also cause a trip ( $E_{L} n$ ) rendering sensorless vector control unusable.

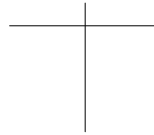
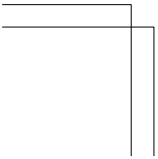
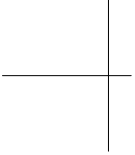

parameter.

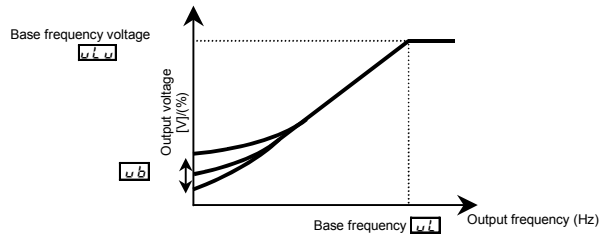

6

[Parameter setting]

Title	Function	Adjustment range	Default setting
$\omega_b$	Torque boost value 1	0.0 - 30.0 (%)	According to model (Refer to section 11.4)

★ Valid when  $P_L$  is set to 0 (V/F constant), 1 (Variable torque), or 7 (V/F 5-point setting).

Note 1: The optimum value is programmed for each inverter capacity by default setting. Be careful not to increase the torque boost rate too much because it could cause an overcurrent trip at startup.



- Function

When the output frequency exceeds the setting of  $F 100$ , an ON signal will be generated. This signal can be used as an operation signal when  $F 100$  is set to 0.0Hz, because an ON signal is put out if the output frequency exceeds 0.0Hz. This signal can also be used as an electromagnetic brake excitation/release signal.

★ Output from the relay output terminal RY-RC. (Default)

Output from the terminal FLA-FLB-FLC and OUT are possible by the parameter settings.

[Parameter setting]

Title	Function	Adjustment range	Default setting
$F 100$	Low-speed signal output frequency	0.0 - $F H$ (Hz)	0.0

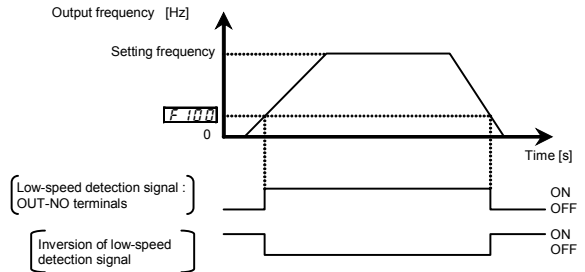

- Output terminal setting

Low-speed signal (ON signal) is output from RY-RC terminal by default setting.

Change this setting to invert the polarity of the signal.

[Parameter setting]

Title	Function	Adjustment range	Default setting
$F 130$	Output terminal selection 1A (RY-RC)	0-255 (Refer to section 11.7)	4: LOW (Low-speed detection signal)

Setting value 5 is reverse signal.

Note) Set  $F 132$  to output to FLA-FLC-FLB terminals and  $F 131$  to OUT terminal.

[Parameter setting]

■Parameter setting of designated frequency and detection band

Title	Function	Adjustment range	Default setting
$F 102$	Speed reach detection band	0.0- $F H$ (Hz)	2.5

■Parameter setting of output terminal selection

Title	Function	Adjustment range	Default setting
$F 131$	Output terminal selection 2A (OUT)	0-255 (Refer to section 11.7.)	6: RCH (Output frequency attainment signal (acceleration/deceleration completed))

Setting value 7 is reverse signal.

Note: Set  $F 132$  to output to FLA-FLC-FLB terminals and  $F 130$  to RY-RC terminal.

6

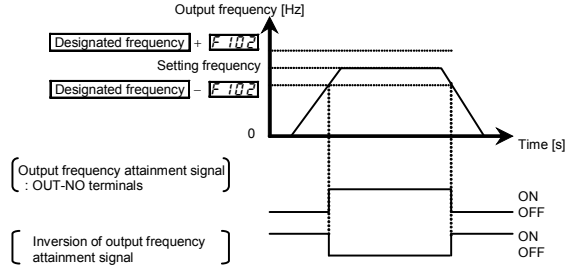

signal is generated.

[Parameter setting]

■Parameter setting of frequency and detection band

Title	Function	Adjustment range	Default setting
$F 10 1$	Speed reach setting frequency	0.0- $F H$ (Hz)	0.0
$F 10 2$	Speed reach detection band	0.0- $F H$ (Hz)	2.5

■Parameter setting of output terminal selection

Title	Function	Adjustment range	Setting
$F 13 1$	Output terminal selection 2A (OUT)	0-255 (Refer to section 11.7.)	8: RCHF (Set frequency attainment signal)

Setting value 9 is reverse signal.

Note: Set  $F 13 2$  to assign to FLA-FLC-FLB terminals and  $F 13 0$  to RY-RC terminal.

If the detection band value + the set frequency is less than the designated frequency

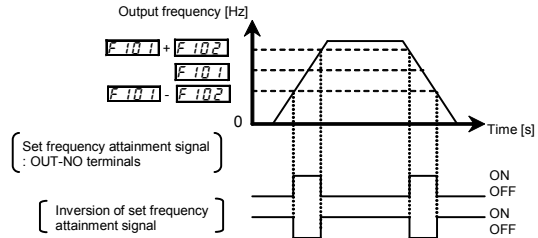

This parameter allows you to select the direction in which the motor runs when a forward run (F) command and a reverse run (R) command are entered simultaneously.

- 1) Reverse
- 2) Deceleration stop

[Parameter setting]

Title	Function	Adjustment range	Default setting
F105	Priority selection (Both F and R are ON)	0: Reverse 1: Deceleration stop	1

6

(1) [F105 = 0 (Reverse)]: If an F command and an R command are entered simultaneously, **the motor will run in the reverse direction.**

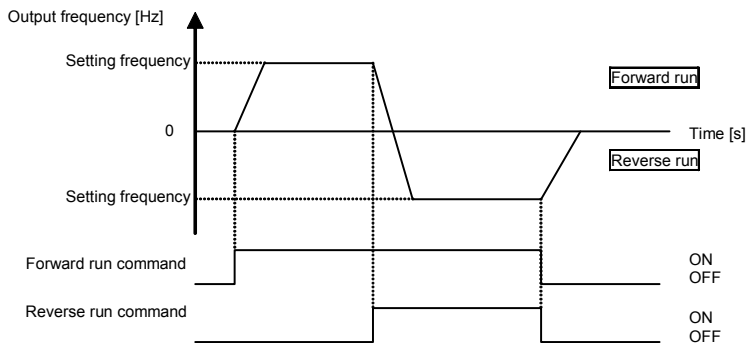

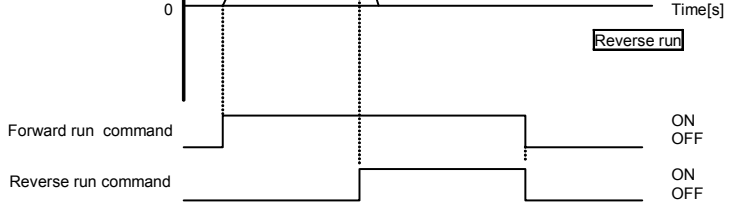

## 6.6.2 Changing the voltage range of VIB terminal

**F107**: Analog input terminal selection (VIB)

- Function  
This parameter allows you to choose the voltage signal input for the VIB terminal.

[Parameter setting]

Title	Function	Adjustment range	Default setting
F107	Analog input terminal selection (VIB)	0: 0-+10V 1: -10-+10V	0

☆ F107=0 : Input 0 to +10Vdc to VIB-CC terminals.

Resolution is maximum 1/1000 between 0 to +10Vdc.

☆ F107=1 : Input -10 to +10Vdc to VIB-CC terminals.

Resolution is maximum 1/2000 between -10 to +10Vdc.

[Parameter setting]

Title	Function	Adjustment range	Default setting
<i>F 109</i>	Analog/logic input selection (VIA/VIB)	0: VIA - analog input VIB - analog input	0
		1: VIA - analog input VIB - contact input	
		2: -	
		3: VIA - contact input (Sink) VIB - contact input	
		4: VIA - contact input (Source) VIB - contact input	

Note) When using VIA terminal as contact input terminals, be sure to insert a resistor between P24 terminal and VIA terminal in sink logic connection, and insert a resistor between VIA terminal and CC terminal in source logic connection. (Recommended resistance: 4.7kΩ-1/2W)

When using VIB terminal as contact input terminals, set the upper side of slide switch SW2 to S4 side and then set *F 109*.

6

- Function

This parameter specifies an input terminal function that is always to be kept active (ON).

**Parameter setting**

Title	Function	Adjustment range	Default setting
F104	Always active function selection 1	0-153 (Refer to section 11.6.)	0 (No function)
F108	Always active function selection 2	0-153 (Refer to section 11.6.)	0 (No function)
F110	Always active function selection 3	0-153 (Refer to section 11.6.)	6 (ST)

★Explanation of the coast stop function

When ST (Standby) is OFF, coast stops.  
 The default setting for ST (Standby) is ON. Please change the following settings:

- F110=0 (no function)
- Assign open input terminal 6: ST (Standby).

Coast stops if terminal set for ST (Standby) is set to OFF. The monitor on the inverter at this time displays 0FF

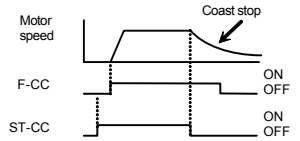

Note1) Input terminal function 8, 9 (Reset command and its inversion) cannot be assigned.

**F115**: Input terminal selection 5 (S2)    **F155**: Input terminal selection 1C (F)

**F116**: Input terminal selection 6 (S3)    **F156**: Input terminal selection 2C (R)

**F109**: Analog/logic input selection  
(VIA/VIB)

**F144**: Input terminal response time

**F117**: Input terminal selection 7 (VIB)

**F146**: Logic input/ pulse input  
selection (S2)

**F118**: Input terminal selection 8 (VIA)

**F147**: Logic input/ PTC input  
selection (S3)

⇒ Refer to section 7.2.1 for details about input terminal functions.

### 6.7.3 Modifying output terminal functions

**F130**: Output terminal selection 1A (RY-RC)

**F131**: Output terminal selection 2A (OUT)

**F132**: Output terminal selection 3 (FL)

**F137**: Output terminal selection 1B (RY-RC)

**F138**: Output terminal selection 2B (OUT)

**F139**: Output terminal logic selection (RY-RC, OUT)

⇒ Refer to section 7.2.2 for details about output terminal functions.



**F112**: Torque boost value 2

**F173**: Motor electronic-thermal protection level 2

**F185**: Stall prevention level 2

• Function

Use the above parameters to switch the operation of two motors with a single inverter and to select motor V/F characteristics (two types) according to the particular needs or operation mode.

Note: The  $P\check{E}$  (V/F control mode selection) parameter is enabled only for motor 1.  
If motor 2 is selected, V/F control will be given constant torque characteristics.

Parameter setting

Title	Function	Adjustment range	Default setting
<i>F170</i>	Base frequency 2	20.0-500.0	*1
<i>F171</i>	Base frequency voltage 2	50-330 (V) (240V class) 50-660 (V) (500V class)	*1
<i>F172</i>	Torque boost value 2	0.0-30.0 (%)	Depending on model (Refer to section 11.4)
<i>F173</i>	Motor electronic-thermal protection level 2	10-100 (%) / (A) *2	100
<i>F185</i>	Stall prevention level 2	10-199 (%) / (A), 200 : Disabled *2	150

\*1: Default setting values vary depending on the setup menu. Refer to section 11.5.

\*2: The inverter's rated current is 100%. When  $F170$  / (current and voltage unit selection) =  $I$  (A (amps)/V (volts)) is set, it can be set at A (amps).

6

OFF	OFF	OFF	OFF	OFF	<i>tHr, RCL, dEC, F502, F601</i>
ON	OFF	OFF	OFF	OFF	<i>RCL → F500, dEC → F501, F502 → F503</i>
OFF	ON	OFF	OFF	OFF	<i>RCL → F510, dEC → F511, F502 → F512</i>
OFF	OFF	ON	OFF	OFF	During stop: <i>Pt → V/F constant, uL → F170, uLv → F171, ub → F172, tHr → F173</i> During run: <i>uL → F170, uLv → F171, ub → F172</i>
OFF	OFF	OFF	ON	OFF	<i>F601 → F185</i>
-	OFF	-	-	ON	<i>Pt → 0, uL → F170, uLv → F171, ub → F172, tHr → F173 (tHr is fixed when F632=2 or 3), F601 → F185, RCL → F500, dEC → F501, F502 → F503</i>

Note 1: Each of the following numbers (25, 27, 29, 33, 153) are reverse signals.

Note 2: *Pt* and "V/F constant" cannot be switched while running. Stop the motor before switching.

*uL* and *F170*, *uLv* and *F171*, *ub* and *F172* can be switched while running.

Note 3: If motor is switched, the setting to retain and subtract an integral value of motor electronic thermal is possible.

Refer to section 5.6 for details.

■ Example of setting a terminal for switching: Sink logic

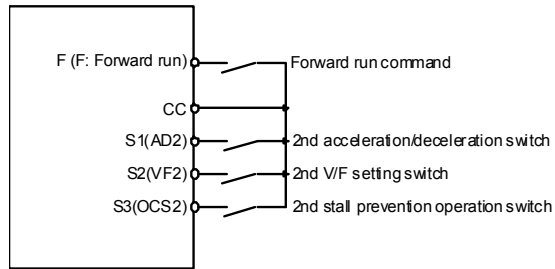

**F154** : V/f 5-point setting VF3 frequency

**F195** : V/f 5-point setting VF3 voltage

⇒ For details, refer to 8) of section 6.13.

## 6.10 Frequency priority selection

---

### 6.10.1 Using two frequency commands according to the particular situation

**F00d** : Frequency setting mode selection 1

**F200** : Frequency priority selection

**F207** : Frequency setting mode selection 2

⇒ For details, refer to section 5.8.

<b>F203</b>	VIA input point 2 setting
<b>F204</b>	VIA Input point 2 frequency
<b>F209</b>	Analog input filter
<b>F210</b>	VIB input point 1 setting
<b>F211</b>	VIB input point 1 frequency
<b>F212</b>	VIB input point 2 setting
<b>F213</b>	VIB input point 2 frequency
<b>F216</b>	VIC input point 1 setting
<b>F217</b>	VIC input point 1 frequency
<b>F218</b>	VIC input point 2 setting
<b>F219</b>	VIC input point 2 frequency
<b>F810</b>	Communication command point selection
<b>F811</b>	Communication command point 1 setting
<b>F812</b>	Communication command point 1 frequency
<b>F813</b>	Communication command point 2 setting
<b>F814</b>	Communication command point 2 frequency

- Function

Output frequency is adjusted in relation to frequency command according to external analog signals.  
VIA and VIB terminals are set to analog input.

**F209** analog input filter is effective for eliminating noise from frequency setting circuit. Increase the value if operation cannot be done because noise effects stability.

★ To fine adjust the frequency command characteristics for analog input, use the parameters **F470** to **F475**. (Refer to section 6.10.3)

		3: VIA - contact input (Sink) VIB - contact input	
		4: VIA - contact input (Source) VIB - contact input	
F201	VIA input point 1 setting	0-100 (%)	0
F202	VIA input point 1 frequency	0.0-500.0 (Hz)	0.0
F203	VIA input point 2 setting	0-100 (%)	100
F204	VIA input point 2 frequency	0.0-500.0 (Hz)	*1
F209	Analog input filter	2-1000 (ms)	64
F210	VIB input point 1 setting	-100-+100 (%)	0
F211	VIB input point 1 frequency	0.0-500.0 (Hz)	0.0
F212	VIB input point 2 setting	-100-+100 (%)	100
F213	VIB input point 2 frequency	0.0-500.0 (Hz)	*1
F216	VIC input point 1 setting	0-100 (%)	0
F217	VIC input point 1 frequency	0.0-500.0 (Hz)	0
F218	VIC input point 2 setting	0-100 (%)	100
F219	VIC input point 2 frequency	0.0-500.0 (Hz)	*1
F810	Communication command point selection	0: Disabled 1: Enabled	0
F811	Communication command point 1 setting	0-100 (%)	0
F812	Communication command point 1 frequency	0.0- <i>F H</i> (Hz)	0
F813	Communication command point 2 setting	0-100 (%)	100
F814	Communication command point 2 frequency	0.0- <i>F H</i> (Hz)	*1

\*1: Default setting values vary depending on the setup menu. Refer to section 11.5.

Note 1: Do not set point 1 and 2 to the same value. If they are set to the same value, *E r r i* is displayed.

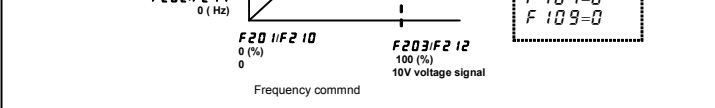

2) 4-20mA current input adjustment (VIC terminal)

6

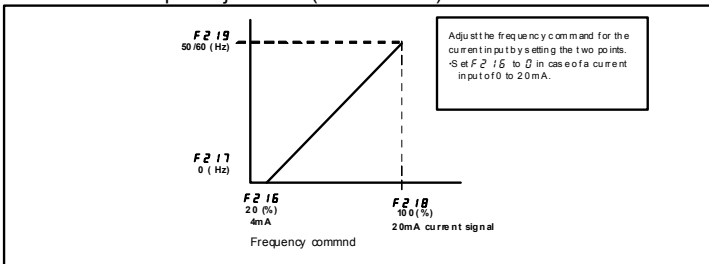

3) -10-+10 Vdc voltage input adjustment (VIB terminal)

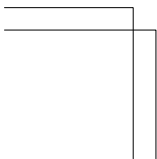
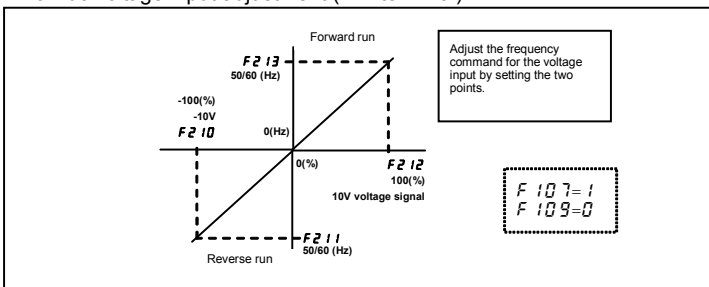

These parameters are used to fine adjust the relation between the frequency command input through the analog input terminal VIA, VIB, VIC and the output frequency.  
 Use these parameters to make fine adjustments after making rough adjustments using the parameters *F201* to *F204*, *F210* to *F213*, *F216* to *F219*

The figure below shows the characteristic of the frequency command input through the VI terminal and that of the output frequency.

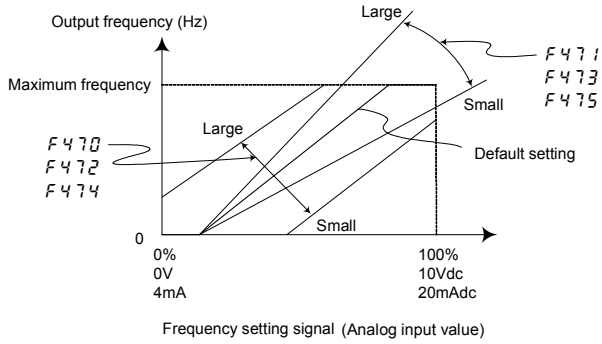

- \* Bias adjustment of analog input terminal (*F470*, *F472*, *F474*)  
 Decrease the value in case frequency is output even though the frequency command is 0 (zero) Hz.
- \* Gain adjustment of analog input terminal (*F471*, *F473*, *F475*)  
 Increase the value in case the output frequency doesn't reach the maximum frequency even though the maximum voltage and current are applied.

**F268**: Initial value of UP/DOWN frequency

**F269**: Change of the initial value of UP/DOWN frequency

- Function

These parameters are used to set an output frequency by means of a signal from an external device.

[Parameter setting]

Title	Function	Adjustment range	Default setting
F264	External logic input - UP response time	0.0 - 10.0 (s)	0.1
F265	External logic input - UP frequency steps	0.0 - FH (Hz)	0.1
F266	External logic input - DOWN response time	0.0 - 10.0 (s)	0.1
F267	External logic input - DOWN frequency steps	0.0 - FH (Hz)	0.1
F268	Initial value of UP/DOWN frequency	LL - UL (Hz)	0.0
F269	Change of the initial value of UP/DOWN frequency	0: Not changed 1: Setting of F268 changed when power is turned off	1

☆ This function is valid when the parameter *Fnd* (Frequency setting mode selection 1) = 5 is set.

### ■ Input terminal settings

Assigning the following functions to the input terminal will allow you to change (up/down) or clear the output frequency by using the terminal's ON/OFF.

Input terminal function		ON	OFF
88	Frequency UP	Frequency setting increase	Clear
90	Frequency DOWN	Frequency setting decrease	Clear
92	Clear frequency UP/DOWN	OFF → ON: External logic up/down frequency clear settings	F268 settings

Each of the following numbers (89, 91, 93) are reverse signals.



(F H I d E C) = (F 2 5 7 / F 2 5 6 setting time)  
 (F H I d E C) ≥ (F 2 5 7 / F 2 5 6 setting time)

<<Sample sequence diagram 1: Adjustment with continuous signals>>

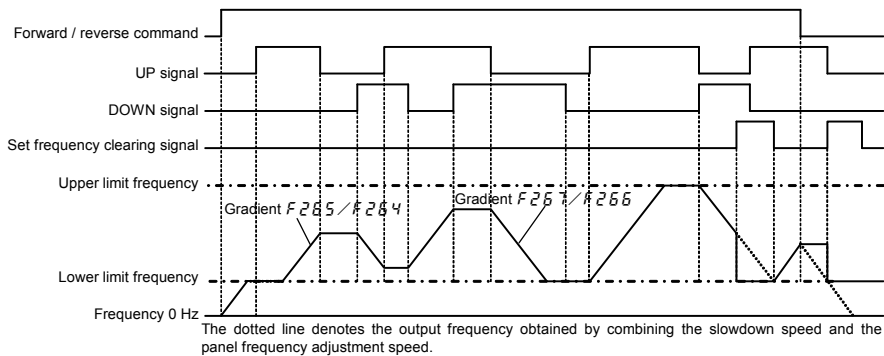

■ Adjustment with pulse signals (Operation example 2)

Set parameters as follows to stepwise adjust the frequency by one pulse:

$F 2 5 4, F 2 5 5 \leq$  Pulse On time

$F 2 5 5, F 2 5 7 =$  Frequency obtained with each pulse

\* The inverter does not respond to any pulses with an ON time shorter than that set with  $F 2 5 4$  or  $F 2 5 5$ . 12ms or more of clearing signal is allowed.

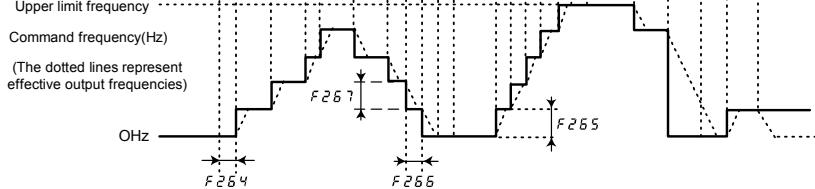

## 6

### ■ If two signals are impressed simultaneously

- If a clear single and an up or down signal are impressed simultaneously, priority will be given to the clear signal.
- If up and down signals are impressed simultaneously, the frequency will change at the specified up or down rate.

### ■ The setting of the initial up/down frequency

To adjust the frequency starting at a specified frequency other than 0.0 Hz (default initial frequency) after turning on the inverter, specify the desired frequency by setting the parameter  $F258$  (initial up/down frequency). Also, set  $F259$  (change of initial up/down frequency) to 0 (Not changed).

### ■ The change of the initial up/down frequency

To make the inverter automatically save the frequency immediately before the power is off and start operation at that frequency next time power is on, set  $F259$  (change of initial up/down frequency) to 1 (which changes the setting of  $F258$  when power is turned off).

Keep in mind that the setting of  $F258$  is changed each time power is turned off.

### ■ Frequency adjustment range

The frequency can be set from  $L$  (lower limit frequency) to  $F$  (Maximum frequency). The lower-limit frequency will be set as soon as the set frequency clearing function (function number 92, 93) is entered from the input terminal.

### ■ Minimum unit of frequency adjustment

If  $F702$  (Frequency free unit magnification) is set to 1.00, the output frequency can be adjusted in steps of 0.01Hz.

These parameters are used to set output frequency by means of pulse train input signal of S2 terminal.

[Parameter setting]

Title	Function	Adjustment range	Default setting
<i>F 146</i>	Logic input / pulse train input selection (S2)	0: Logic input 1: Pulse train input	0
<i>F 378</i>	Number of pulse train input	10-500 (pps)	25
<i>F 679</i>	Pulse train input filter	2-1000 (ms)	2

☆ This function is valid when the parameter *F 00d = 11* (Pulse train input) and *F 146 = 1* (Pulse train input) are set.

☆ Number of pulses per 1Hz is set by parameter *F 378*.

☆ Example of setting

<i>F 378</i> = 25 (pps) :	Input signal = 25 (pps)	⇒ Output frequency = 1.0 (Hz)
	Input signal = 100 (pps)	⇒ Output frequency = 4.0 (Hz)
<i>F 378</i> = 50 (pps) :	Input signal = 2k (pps)	⇒ Output frequency = 80.0 (Hz)
	Input signal = 50 (pps)	⇒ Output frequency = 1.0 (Hz)
<i>F 378</i> = 50 (pps) :	Input signal = 100 (pps)	⇒ Output frequency = 2.0 (Hz)
	Input signal = 2k (pps)	⇒ Output frequency = 40.0 (Hz)

(Note) Minimum number of pulses to inputting S2 terminal is 10 pps, and Maximum is 2 kpps.

- Function

The frequency set with  $F 240$  is put out instantly when operation is started.  
 Use the  $F 240$  parameter when a delay in response of starting torque due to the acceleration/deceleration time may affect the operation. Setting the starting frequency to a value from 0.5 to 3.0Hz is recommended. The occurrence of an overcurrent can be avoided by setting this frequency below the rated slippage of the motor.

When starting: Frequency set with  $F 240$  is output instantly.

When stopping: Output frequency turns to be 0Hz instantly with the frequency set with  $F 243$ .

[Parameter setting]

Title	Function	Adjustment range	Default setting
$F 240$	Starting frequency	0.1-10.0 (Hz)	0.5
$F 243$	Stop frequency setting	0.0: Same as $F 240$ 0.1-30.0 (Hz)	0.0

6

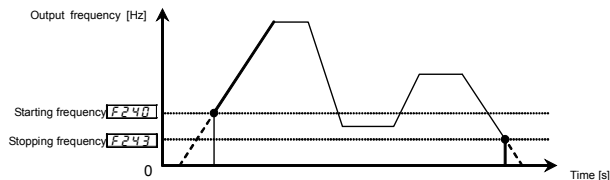

Note: Set these parameters so that the starting frequency  $F 240$  is higher than the stopping frequency  $F 243$ .  
 If the  $F 240$ -set frequency is lower than the  $F 243$ -set frequency, the inverter doesn't start when the frequency command is  $F 243$ -set frequency or less.

Parameter Setting

Title	Function	Adjustment range	Default setting
$F241$	Operation starting frequency	$0.0-FH$ (Hz)	0.0
$F242$	Operation starting frequency hysteresis	$0.0-FH$ (Hz)	0.0

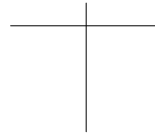
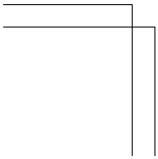
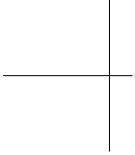
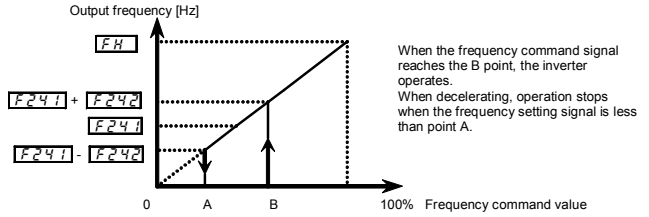

**F252**: DC braking time

- Function

A large braking torque can be obtained by applying a direct current to the motor. These parameters set the direct current to be applied to the motor, the application time and the starting frequency.

[Parameter setting]

Title	Function	Adjustment range	Default setting
F249	PWM carrier frequency during DC braking	2.0-16.0 (kHz)	4.0
F250	DC braking starting frequency	0.0-FH (Hz)	0.0
F251	DC braking current	0.0-100 (%) / (A)	50
F252	DC braking time	0.0- 25.5 (s)	1.0

6

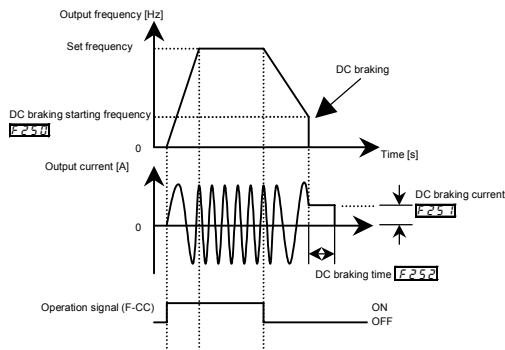

Note1: During DC braking, the overload protection sensitivity of the inverter increases. The DC braking current may be adjusted automatically to prevent tripping.

Note 2: During DC braking, the carrier frequency becomes the setting of whichever is lower parameter F249 or F300.

Note 3: DC braking can be done by using the signal at an input terminal. Input terminal 22: Assign DC braking command (23 is reverse). DC braking is applied while the terminal is ON regardless of the F250, F252 settings. Even if the terminal is OFF, DC braking is applied only for the F252 time. The amount of DC braking depends on the F251 settings.

Parameter setting			
Title	Function	Adjustment range	Default setting
F254	Motor shaft fixing control	0: Disabled, 1: Enabled	0

If the motor shaft fixing control F254 is set to 1, half amount of the braking force set with F251 (DC braking rate) will make the motor continue DC braking even after the completion of ordinary DC braking. To stop motor shaft fixing control, turn off the standby command (ST signal).

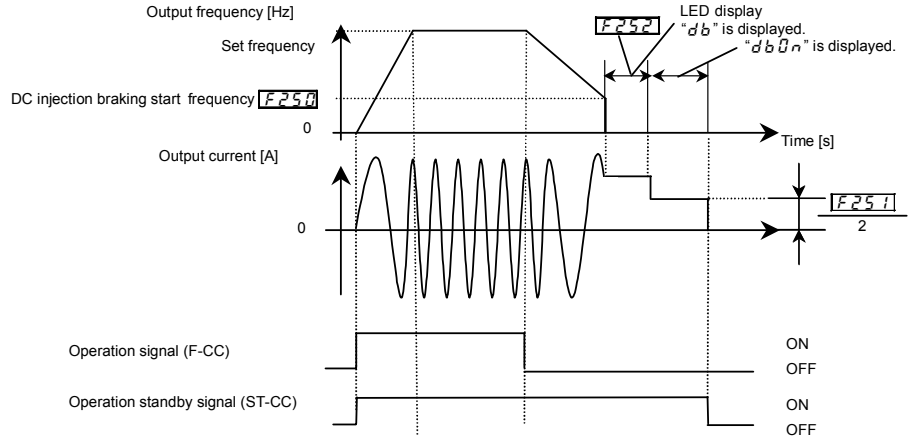

As the default setting for ST (Standby) is Always ON, change the following settings:

- F110=0 (no function)
- Assign 6: ST (Standby) to an open input terminal.

Note1: Nearly the same motor shaft fixing control can be exercised when entering a DC braking command with the signal at an input terminal.

Note2: If a power failure occurs during motor shaft fixing control and the motor starts to coast, motor shaft fixing control will be canceled.

Also, if the inverter trips during motor shaft fixing control and is restored to working order by the retry

**F391: Hysteresis for lower-limit frequency operation**

• Function

If operation at the lower-limit frequency ( $LL$ ) is carried out for the time set with  $F256$ , the inverter will automatically decelerate the motor to stop for the purpose of energy-saving. At that time, "L5LP" is displayed (alternately) on the operation panel.

Stop by this function will be canceled if a frequency command value exceeds the lower-limit frequency ( $LL$ ) +  $F391$  (Hz), or if the operation command is OFF. This function will not work until the output frequency reaches  $LL$  at the start of operation.

If the output frequency doesn't reach  $LL$  at the start of operation for malfunction of load, the inverter will automatically stop after the time set with  $F259$  elapses.

6

[Parameter setting]

Title	Function	Adjustment range	Default setting
F256	Time limit for lower-limit frequency operation	0.0: Disabled 0.1 - 600.0 (s)	0.0
F259	Lower limit frequency reach time limit at start-up	0.0: Disabled 0.1 - 600.0 (s)	0.0
F391	Hysteresis for lower-limit frequency operation	0.0-LL (Hz)	0.2

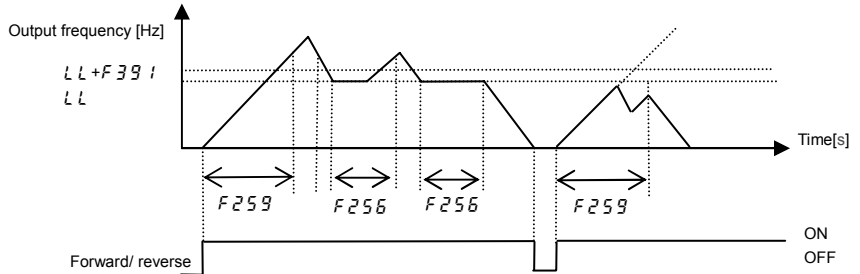

Note: This function is valid when doing forward/reverse switching.

When starting operation,  $F256$  function will not work until output frequency reaches  $LL$ .

When the output frequency exceeds  $LL$ ,  $F259$  function will be invalid until operation signal is OFF.



- Function

Use the jog run parameters to operate the motor in jog mode. Input of a jog run signal immediately generates a jog run frequency output irrespective of the designated acceleration time.

Also, you can choose the jog run start/stop mode from the panel.

Assign 18: jog run mode to an input terminal.

Ex) When assigning it to the RES terminal:  $F 113$  to  $18$ .

The motor can be operated in jog mode while the assigned input terminals are connected (RES-CC ON).

[Parameter setting]

Title	Function	Adjustment range	Default setting
$F 250$	Jog run frequency	$F 240$ -20.0 (Hz)	5.0
$F 251$	Jog run stopping pattern	0: Deceleration stop 1: Coast stop 2: DC braking	0
$F 252$	Panel jog run mode	0: Invalid 1: Valid	0

[Setting of jog run mode (RES-CC)]

Ex) Assign jog run mode to control terminal RES.

Title	Function	Adjustment range	Setting
$F 113$	Input terminal selection (RES)	0-203	18 (Jog run mode)

Note 1: During the jog run mode, low speed detection signal (LOW) is output but designated frequency reach signal (RCH) is not output, and PID control does not work.

Note 2: When only the operation panel is used for operation in jog run mode, the jog run function does not need to be assigned to any input terminal.

<Examples of jog run>

RES (JOG): ON + F:ON: Forward jog run

RES(JOG): ON + R: ON: Reverse jog run

(Frequency command + F: ON: Forward run , Frequency command + R: ON: Reverse run)

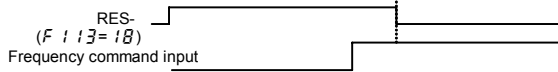

**6**

- The jog run setting terminal (RES-CC) is enabled when the value of operation frequency is that of the jog run frequency and below.  
This connection does not function when operation frequency exceeds the jog run frequency.
- The motor can be operated in jog mode while the jog run setting terminals are connected (RES-CC).
- Jog run has priority to new operation command given during operation.
- Even for  $F 2 5 1 = 0$  or  $1$ , an emergency DC braking ( $F 5 0 3 = 2$ ) is prior to the setting.
- No limits are imposed to the jog run frequency by the upper-limit frequency (parameter  $U 1$ ).

■ Panel jog mode (if  $F 2 5 2$  is set to  $1$ )

- The direction of rotation can change by using extension panel.  
Using RKP007Z : Display switches to  $F J 0 0$  and  $r J 0 0$  by every pressing the FWD/REV key.  
Using RKP002Z : Pressing the UP key changes display to  $F J 0 0$  and pressing the DOWN key changes display to  $r J 0 0$ .
- When  $F J 0 0$  is displayed, the inverter will be placed in forward jog run mode as long as the key is pressed.
- When  $r J 0 0$  is displayed, the inverter will be placed in reverse jog run mode as long as the **RUN** key is pressed.
- If you press and hold down the **RUN** key for 20 seconds or more, the key failure alarm "E - 1 7" will be displayed.

Here is the sequence in which modes change each time you press the **MODE** key.

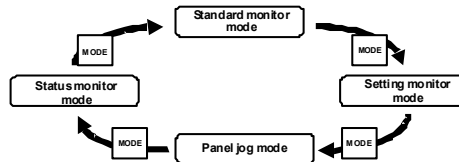

Note: When the inverter is in operation (RUN lamp is blinking) or when an operation command is issued (RUN lamp is lighting), the inverter cannot be switched to panel jog mode.

**F274**: Jump frequency 3

**F275**: Jumping width 3

- Function

Resonance due to the natural frequency of the mechanical system can be avoided by jumping the resonant frequency during operation. During jumping, hysteresis characteristics with respect to the jump frequency are given to the motor.

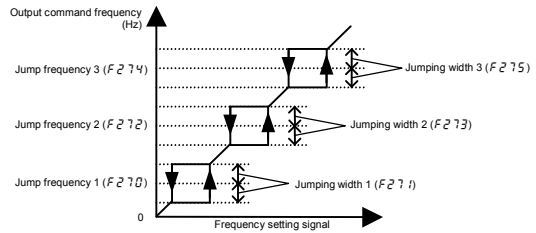

[Parameter setting]

Title	Function	Adjustment range	Default setting
F270	Jump frequency 1	0.0- <i>FH</i> (Hz)	0.0
F271	Jumping width 1	0.0-30.0 (Hz)	0.0
F272	Jump frequency 2	0.0- <i>FH</i> (Hz)	0.0
F273	Jumping width 2	0.0-30.0 (Hz)	0.0
F274	Jump frequency 3	0.0- <i>FH</i> (Hz)	0.0
F275	Jumping width 3	0.0-30.0 (Hz)	0.0

Note 1: Do not set the jump parameters, if multiple jump frequency setting width overlap.

Note 2: During acceleration or deceleration, the jumping function doesn't work for the operation frequency.

When switching from Remote mode to Local mode, the status of start and stop, and operating frequency at Remote mode are moved to Local mode.  
Running status of Local mode will not moved to Remote mode when switching from Local mode to Remote mode.

[Parameter setting]

Title	Function	Adjustment range	Default setting
<i>F 295</i>	Bumpless operation selection	0: Disabled 1: Enabled	0
<i>F 732</i>	Local/remote key prohibition of extension panel	0: Permitted 1: Prohibited	1
<i>F 750</i>	EASY key function selection	0: Easy / standard setting mode switching function 1: Shortcut key 2: Local / remote key 3: Monitor peak / minimum hold trigger 4: - 5: -	0

★ Set Local/remote function to  key.

*F 750* (EASY key function selection) = 2 (Local / remote key).

EASY lamp is lighting during local mode.

★ Local mode is the operation using operation panel.

Remote mode is the operation method selected by the command mode selection: *cmd* and Frequency setting mode selection: *cmd*

★ LOC/REM key of extension panel option (RKP007Z) is available.

In this case, set parameter *F 732* (Local/remote key prohibition of extension panel) = 0 (Permitted).

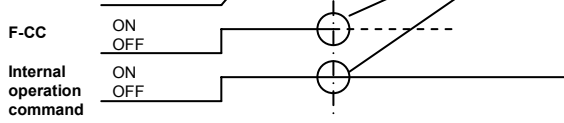

mode to Local mode.  
Motor runs continuously for the case described on the left.

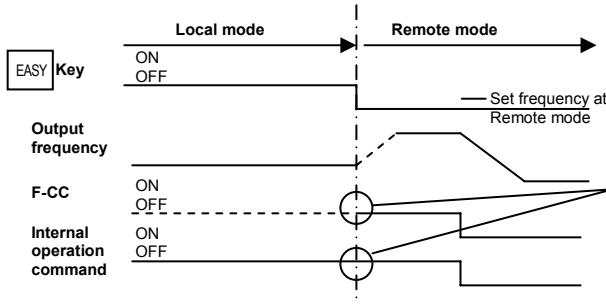
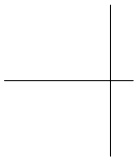

When switching from Local mode to Remote mode, setting frequency and start/stop status are determined by Remote mode status.  
For the case described on the left, the motor runs continuously because the Remote mode is "run" status.

★ To prevent from moving the setting frequency and start/stop status of Remote mode to Local mode, set *F295* to "0"(Disabled). In this case, EASY key is effective only while stopping.

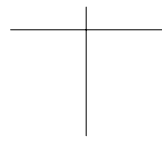
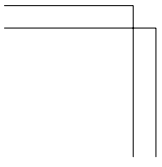

***RUL***: Overload characteristic selection

***F300***: PWM carrier frequency

***F312***: Random mode

***F316***: PWM carrier frequency control mode selection

6

• Function

- 1) With the *F300* parameter, the tone of the magnetic noise from the motor can be changed by switching the PWM carrier frequency. This parameter is also effective in preventing the motor from resonating with its load machine or its fan cover.
- 2) In addition, the *F300* parameter reduces the electromagnetic noise generated by the inverter. Reduce the carrier frequency to reduce electromagnetic noise. Note: The electromagnetic noise level is reduced, but the acoustic noise of the motor is increased.
- 3) The random mode improves hearing impression by changing the pattern of the low carrier frequency.

[Parameter setting]

Title	Function	Adjustment range	Default setting
<i>RUL</i>	Overload characteristic selection	0: - 1: Constant torque characteristic (150%-60s) 2: Variable torque characteristic (120%-60s)	0
<i>F300</i>	PWM carrier frequency	2.0-16.0 (kHz)	12.0
<i>F312</i>	Random mode	0: Disabled 1: Random mode 1 2: Random mode 2 3: Random mode 3	0
<i>F316</i>	PWM carrier frequency control mode selection	0: Carrier frequency without reduction 1: Carrier frequency with automatic reduction 2: Carrier frequency without reduction (Support for 500V models) 3: Carrier frequency with automatic reduction (Support for 500V models)	1

Note 1: Some models need reduced current ratings, depending on *F300* settings and ambient temperature.

Refer to the table on the following pages.

Note 2: Random mode is exercised when the motor is operated in a low-frequency range where it produces annoying acoustic noise.

■ De-rating of rated current

[240V class]

In case of  $RUL = I$  (Constant torque characteristic (150%-60s)) setting.

VFS15- VFS15S-	Ambient temperature	PWM carrier frequency		
		2.0k~4.0kHz	4.1k~12.0kHz	12.1k~16.0kHz
2002PL-W	40°C or less	1.5 A	1.5 A	1.5 A
	40 ~ 50°C	1.5 A	1.2 A	1.2 A
	50 ~ 60°C	1.2 A	1.1 A	1.1 A
2004 PML-W	40°C or less	3.3 A	3.3 A	3.3 A
	40 ~ 50°C	3.3 A	2.6 A	2.6 A
	50 ~ 60°C	2.6 A	2.5 A	2.5 A
2007 PML-W	40°C or less	4.8 A	4.4 A	4.2 A
	40 ~ 50°C	4.8 A	3.5 A	3.4 A
	50 ~ 60°C	3.8 A	3.3 A	3.2 A
2015 PML-W	40°C or less	8.0 A	7.9 A	7.1 A
	40 ~ 50°C	8.0 A	7.9 A	7.1 A
	50 ~ 60°C	7.6 A	6.3 A	5.7 A
2022 PML-W	40°C or less	11.0 A	10.0 A	9.1 A
	40 ~ 50°C	11.0 A	10.0 A	9.1 A
	50 ~ 60°C	10.5 A	8.0 A	7.3 A
2037PM-W	40°C or less	17.5 A	16.4 A	14.6 A
	40 ~ 50°C	17.5 A	16.4 A	14.6 A
	50 ~ 60°C	16.6 A	13.1 A	11.7 A
2055PM-W	40°C or less	27.5 A	25.0 A	25.0 A
	40 ~ 50°C	27.5 A	25.0 A	25.0 A
	50 ~ 60°C	26.1 A	20.0 A	20.0 A
2075PM-W	40°C or less	33.0 A	33.0 A	29.8 A
	40 ~ 50°C	33.0 A	33.0 A	29.8 A
	50 ~ 60°C	31.4 A	26.4 A	23.8 A
2110PM-W	40°C or less	54.0 A	49.0 A	49.0 A
	40 ~ 50°C	54.0 A	49.0 A	49.0 A
	50 ~ 60°C	51.3 A	39.2 A	39.2 A
2150PM-W	40°C or less	66.0 A	60.0 A	54.0 A
	40 ~ 50°C	66.0 A	60.0 A	54.0 A
	50 ~ 60°C	62.7 A	48.0 A	43.2 A

2037PM-W	40°C or less	19.6 A
2055PM-W	40°C or less	30.0A
2075PM-W	40°C or less	38.6 A
2110PM-W	40°C or less	56.0 A
2150PM-W	40°C or less	69.0A

6

VFS15S-	Ambient temperature	PWM carrier frequency
		2.0k~4.0kHz
2002 PL-W	40°C or less	1.9A
2004 PL-W	40°C or less	4.1 A
2007 PL-W	40°C or less	5.5A
2015 PL-W	40°C or less	10.0 A
2022 PL-W	40°C or less	12.0A



4007 PL-W	50 ~ 60°C	2.2 A	1.7 A	1.7 A
	40°C or less	4.1 A	3.7 A	3.3 A
	40 ~ 50°C	4.1 A	3.7 A	3.3 A
4015 PL-W	50 ~ 60°C	3.9 A	3.0 A	2.6 A
	40°C or less	5.5 A	5.0 A	4.5 A
	40 ~ 50°C	5.5 A	5.0 A	4.5 A
4022 PL-W	50 ~ 60°C	5.2 A	4.0 A	3.6 A
	40°C or less	9.5 A	8.6 A	7.5 A
	40 ~ 50°C	9.5 A	8.6 A	7.5 A
4037 PL-W	50 ~ 60°C	9.0 A	6.9 A	6.0 A
	40°C or less	14.3 A	13.0 A	13.0 A
	40 ~ 50°C	14.3 A	13.0 A	13.0 A
4055 PL-W	50 ~ 60°C	13.6 A	10.4 A	10.4 A
	40°C or less	17.0 A	17.0 A	14.8 A
	40 ~ 50°C	17.0 A	17.0 A	14.8 A
4075 PL-W	50 ~ 60°C	16.2 A	13.6 A	11.8 A
	40°C or less	27.7 A	25.0 A	25.0 A
	40 ~ 50°C	27.7 A	25.0 A	25.0 A
4110 PL-W	50 ~ 60°C	26.3 A	20.0 A	20.0 A
	40°C or less	33.0 A	30.0 A	26.0 A
	40 ~ 50°C	33.0 A	30.0 A	26.0 A
4150 PL-W	50 ~ 60°C	31.4 A	24.0 A	20.8 A

6

4015 PL-W	40 ~ 50°C	3.8 A	3.4 A	3.1 A
	50 ~ 60°C	3.6 A	2.7 A	2.5 A
	40°C or less	5.1 A	4.6 A	4.2 A
4022 PL-W	40 ~ 50°C	5.1 A	4.6 A	4.2 A
	50 ~ 60°C	4.8 A	3.7 A	3.4 A
	40°C or less	8.7 A	7.9 A	6.9 A
4037 PL-W	40 ~ 50°C	8.7 A	7.9 A	6.9 A
	50 ~ 60°C	8.3 A	6.3 A	5.5 A
	40°C or less	13.2 A	12.0 A	12.0 A
4055 PL-W	40 ~ 50°C	13.2 A	12.0 A	12.0 A
	50 ~ 60°C	12.5 A	9.6 A	9.6 A
	40°C or less	15.6 A	14.2 A	12.4 A
4075 PL-W	40 ~ 50°C	15.6 A	14.2 A	12.4 A
	50 ~ 60°C	14.8 A	11.4 A	9.9 A
	40°C or less	25.5 A	23.0 A	23.0 A
4110 PL-W	40 ~ 50°C	25.5 A	23.0 A	23.0 A
	50 ~ 60°C	24.2 A	18.4 A	18.4 A
	40°C or less	30.4 A	27.6 A	24.0 A
4150 PL-W	40 ~ 50°C	30.4 A	27.6 A	24.0 A
	50 ~ 60°C	28.9 A	22.1 A	19.2 A

4037 PL-W	40°C or less	11.1 A
4055 PL-W	40°C or less	17.0A
4075 PL-W	40°C or less	23.0 A
4110 PL-W	40°C or less	31.0A
4150 PL-W	40°C or less	38.0A

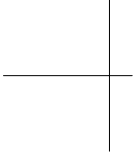

- \* In case of  $RUL = 2$  setting, be sure to install the input AC reactor (ACL) between power supply and inverter and use at ambient temperature 40°C or less. Set  $F300$  to 4.0 kHz or less.
- \* If parameter  $F316 = 0$  or  $2$  and current is increased to main module overheat level ( $OL3$ ) or to overheat level ( $OH$ ), the  $L$  alarm or  $H$  alarm occurs. If the cumulative amount of overload is increased further,  $OL3$  trip or  $OH$  trip occurs.  
In this case, to avoid such trips, reduce the stall prevention level ( $F501$ ) properly.
- \* If parameter  $F316 = 2$  or  $3$ , setting parameter  $F300$  to 4.0kHz or less is recommended. Output voltage may be reduced.
- \* PWM carrier frequency is increased at high output frequency area for stable operation, even if  $F300$  is set to low PWM carrier frequency.

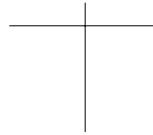
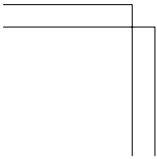

## 6.19.2 Regenerative power ride-through control/Deceleration stop during power failure/Synchronized acceleration/deceleration

**F302** : Regenerative power ride-through control (Deceleration stop)

**F317** : Synchronized deceleration time

**F318** : Synchronized acceleration time

6

### • Function

- 1) Regenerative power ride-through control: When momentary power failure occurs during operation, this function makes operation continue using the regeneration energy from a motor.
- 2) Deceleration stop during power failure: When momentary power failure occurs during operation, this function stops the motor quickly and compulsorily using the regeneration energy from the motor. (Deceleration time varies according to control.) When operation is stopped, the message "S t P" blinks on the operation panel. After the forced stop, the inverter remains static until you put off the operation command momentarily.
- 3) Synchronized acceleration/deceleration: When the inverter is used with textile machines, this function decelerate the motors synchronously to stop in the event of a momentary power failure and accelerate them to reach the targeted frequency commands synchronously at the recovery from the power failure in order to prevent thread breakage.

[Parameter setting]

Title	Function	Adjustment range	Default setting
<b>F302</b>	Regenerative power ride-through control (Deceleration stop)	0: Disabled 1: Regenerative power ride-through control 2: Deceleration stop during power failure 3: Synchronized acceleration / deceleration (signal) 4: Synchronized acceleration / deceleration (signal + power failure)	0
<b>F317</b>	Synchronized deceleration time (time elapsed between start of deceleration to stop)	0.0-3600 (360.0) (s)	2.0
<b>F318</b>	Synchronized acceleration time	0.0-3600 (360.0) (s)	2.0

■ An example of setting when  $F302=1$   
[When power is interrupted]

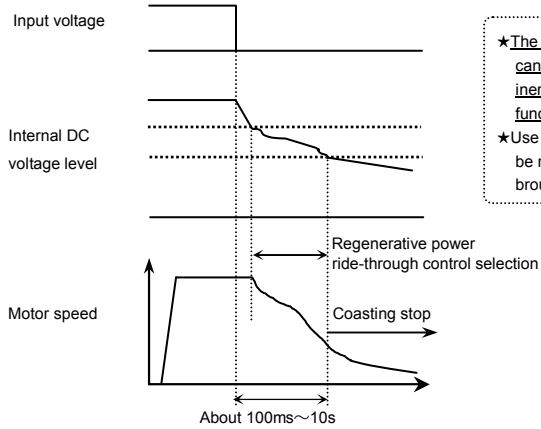

★The time for which the operation of the motor can be continued depends on the machine inertia and load conditions. Before using this function, therefore, perform verification tests.

★Use with the retry function allows the motor to be restarted automatically without being brought to an abnormal stop.

Note 4: If power is interrupted during deceleration stop, power ride-through control will not be performed.

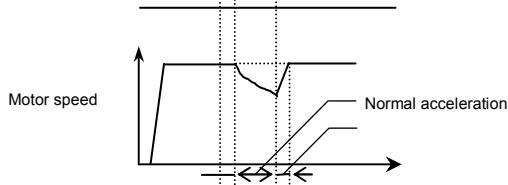

Note 5: If momentary power failure occurs during deceleration stop, power ride-through control will not be performed.

■ An example of setting when  $F302=2$

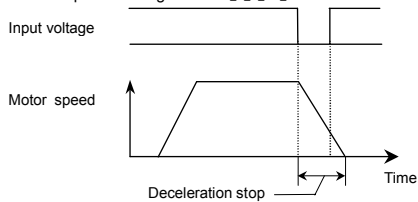

- Even after the recovery from an input power failure, the motor continues deceleration stop. If the voltage in the inverter main circuit falls below a certain level, however, control will be stopped and the motor will coast.
- If the voltage in main circuit falls below main circuit undervoltage ( $UVF$ ) level at Non-stop control during power failure, the motor will coast and inverter displays  $5tOP$  and  $0.0$  alternately. The motor continues coasting even after power supply is restored.

Motor speed

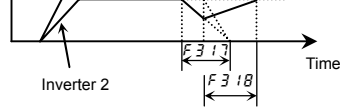

- If the parameters  $F317$ ,  $F318$  are set for same acceleration and deceleration time and if power failure synchronized signal of the input terminal functions ( $\delta 2$ ,  $\delta 3$ ) are used, multiple motors can be stopped at about the same time or make them reach each frequency command.
- If a power failure synchronized signal is ON, the synchronized deceleration function decreases the output frequency to 0Hz to decelerate the motor linearly within the time specified with  $F317$ . (The S-pattern operation function or the braking sequence cannot be used along with this function.)  
When the motor comes to a full stop, the message "5 E OP" appears.
- If the power failure synchronized signal is canceled during synchronized deceleration, the synchronized acceleration function increases the output frequency to the frequency at the start of synchronized deceleration or to the command frequency, whichever is lower, to accelerate the motor linearly within the time specified with  $F318$ . (The S-pattern operation function, the braking sequence or the auto-tuning function cannot be used along with this function.)  
When acceleration is started, the message "5 E OP" disappears.
- If a forward/reverse switching command or a stop command is issued during synchronized acceleration or deceleration, synchronized acceleration or deceleration will be canceled.
- When the motor is started again after the synchronized deceleration function stop, turn off the power failure synchronized signal.
- In case of using the synchronized deceleration function, make sure that overvoltage limit operation is not working during deceleration.

■ An example of setting when  $F302=4$

Synchronized deceleration if a power failure synchronized signal is ON or if a power failure occurs. Synchronized acceleration if the power failure synchronized signal is canceled or power is restored.

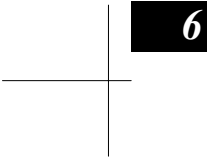

F-64

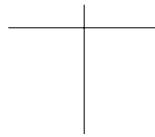
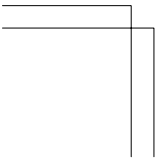



Mandatory  
action

• Attach caution label about sudden restart in retry function on inverters, motors and equipment for prevention of accidents in advance.

• Function

This parameter resets the inverter automatically when the inverter gives an alarm. During the retry mode, the motor speed search function operates automatically when necessary and thus allows smooth motor restarting.

[Parameter setting]

Title	Function	Adjustment range	Default setting
F303	Retry selection (number of times)	0: Disabled, 1-10 (Times)	0

The likely causes of tripping and the corresponding retry processes are listed below.

Cause of tripping	Retry process	Canceling conditions
Overcurrent	Up to 10 times in succession	The retry function will be canceled at once if tripping is caused by an unusual event other than: overcurrent, overvoltage, overload, overheating, or step-out. This function will also be canceled if retrying is not successful within the specified number of times.
Overvoltage	1st retry: About 1 sec after tripping	
Overload	2nd retry: About 2 sec after tripping	
Overheating	3rd retry: About 3 sec after tripping	
Step-out (for PM motor only)	10th retry: About 10 sec after tripping	

★ Retry is done only when the following trips occur.

*OC 1, OC 2, OC 3, OP 1, OP 2, OP 3, OL 1, OL 2, OL 3, OH, SOut*

★ Protective operation detection relay signals (FLA, FLB, FLC terminal signals) are not sent during use of the retry function. (Default setting)

★ To allow a signal to be sent to the protective action detection relay (FLA, B and C terminals) even during the retry process, assign function numbers 146 or 147 to F132.

★ A virtual cooling time is provided for overload tripping (OL 1, OL 2).

In this case, the retry function operates after the virtual cooling time and retry time elapsed.

★ In the event of tripping caused by an overvoltage (OP 1 to OP 3), the retry function will not be activated until the voltage in the DC section comes down to a normal level.

★ In the event of tripping caused by overheating (OH), the retry function will not be activated until the temperature in the inverter is lowered enough for restarting operation.

★ During retrying, r L r Y and the monitor display specified by Initial panel display selection parameter, F710, are displayed alternately.

★ The number of retries will be cleared if the inverter is not tripped for the specified period of time after a successful retry.

"A successful retry" means that the inverter output frequency reaches the command frequency without causing the inverter to re-trip.

- Function

The inverter does not contain a braking resistor. Connect an external braking resistor in the following cases to enable dynamic braking function:

- 1) when decelerating the motor abruptly or if overvoltage tripping ( $\overline{OP}$ ) occurs during deceleration stop
- 2) when a continuous regenerative status occurs during downward movement of a lift or the winding-out operation of a tension control machine
- 3) when the load fluctuates and results in a continuous regenerative status even during constant speed operation of a machine such as a press

[Parameter setting]

Title	Function	Adjustment range	Default setting
<i>F304</i>	Dynamic braking selection	0: Disabled 1: Enabled, Resistor overload protection enabled 2: Enabled 3: Enabled, Resistor overload protection enabled (At ST terminal on) 4: Enabled (At ST terminal on)	0
<i>F308</i>	Dynamic braking resistance	1.0-1000 ( $\Omega$ )	Depending on models (See Section 11.4)
<i>F309</i>	Dynamic braking resistor capacity	0.01-30.00 (kW)	
<i>F626</i>	Over-voltage stall protection level	100-150 (%)	136 (240V class) 141 (500V class)

★ Overload status of braking resistor can be output by assigning the braking resistor overload pre-alarm (function number : 30,31) to any logic output terminal.

Note 1) The operation level of dynamic braking is defined by parameter *F626*.

Note 2) In case of parameter *F304*= 1 to 4, the inverter will be automatically set as "without overvoltage limit operation" and controlled so that the resistor consumes the regenerative energy from the motor. (The same function as *F305*= 1)

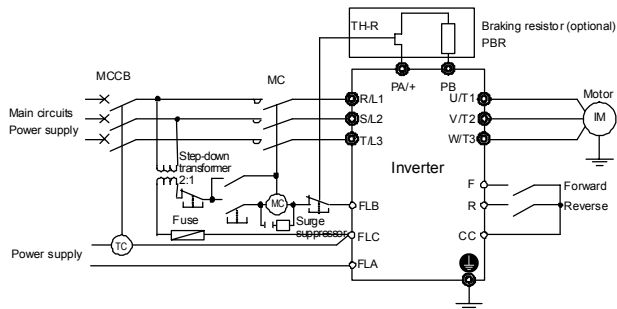
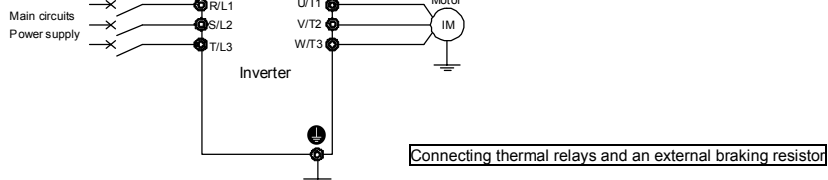

Note 1: A TC (Trip coil) is connected as shown in this figure when an MCCB with a trip coil is used instead of an MC. A step-down transformer is needed for every 500V-class inverter, but not for any 240V-class inverter.

Note 2: As a last resort to prevent fire, be sure to connect a thermal relay (THR). Although the inverter has a means of preventing overload and overcurrent to protect the braking resistor, the thermal relay is activated in case the protection function fails to work. Select and connect a thermal relay (THR) appropriately to the capacity (wattage) of the braking resistor.

- ★ To use this inverter in applications that create a continuously regenerative status (such as downward movement of a lift, a press or a tension control machine), or in applications that require deceleration stopping of a machine with a significant load inertial moment, increase the dynamic braking resistor capacity according to the operation rate required.
- ★ To connect an external dynamic braking resistor, select one with a resultant resistance value greater than the minimum allowable resistance value. Be sure to set the appropriate operation rate in *F308* and *F309* to ensure overload protection.
- ★ When using a braking resistor with no thermal fuse, connect and use a thermal relay as a control circuit for cutting the power off.



6

---

F-68

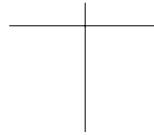
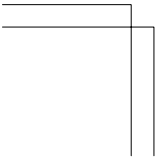

VFS15-2037PM-W	PBR-2037	120W-40Ω	90W
VFS15-2055PM-W, 2075PM-W	PBR7-004W015	440W-15Ω	130W
VFS15-2110PM-W, 2150PM-W	PBR7-008W7R5	880W-7.5Ω	270W
VFS15-4004PL-W~4022PL-W	PBR-2007	120W-200Ω	90W
VFS15-4037PL-W	PBR-4037	120W-160Ω	90W
VFS15-4055PL-W, 4075PL-W	PBR7-004W060	440W-60Ω	130W
VFS15-4110PL-W, 4150PL-W	PBR7-008W030	880W-30Ω	270W

Note 1: The data in Rating above refer to the resultant resistance capacities (watts) and resultant resistance values (Ω).

Note 2: Braking resistors for frequent regenerative braking are optionally available. For more information, contact your Toshiba distributor.

Note 3: Type-form of "PBR-" indicates the thermal fuse". Type-form of "PBR7-" indicates the thermal fuse and thermal relay.

Note 4: The default setting values of parameter  $F308$  (Dynamic braking resistance) and  $F309$  (Dynamic braking resistor capacity) are applied to braking resistor option.

### 3) Minimum resistances of connectable braking resistors

The minimum allowable resistance values of the externally connectable braking resistors are listed in the table below.

Do not connect braking resistors with smaller resultant resistances than the listed minimum allowable resistance values.

Inverter rated output capacity (kW)	240V Class		500V Class	
	Resistance of standard option	Minimum allowable resistance	Resistance of standard option	Minimum allowable resistance
0.2	200Ω	55Ω	-	-
0.4	200Ω	55Ω	200Ω	114Ω
0.75	200Ω	55Ω	200Ω	114Ω
1.5	75Ω	44Ω	200Ω	67Ω
2.2	75Ω	33Ω	200Ω	67Ω
4.0	40Ω	16Ω	160Ω	54Ω
5.5	15Ω	12Ω	60Ω	43Ω
7.5	15Ω	12Ω	60Ω	28Ω
11	7.5Ω	5Ω	30Ω	16Ω
15	7.5Ω	5Ω	30Ω	16Ω

Note: Be sure to set  $F308$  (Dynamic braking resistance) at the resistance of the dynamic braking resistor connected.

These parameters are used to keep the output frequency constant or increase it to prevent overvoltage tripping in case the voltage in the DC section rises during deceleration or varying speed operation. The deceleration time during overvoltage limit operation may increase above the designated time.

#### Overvoltage limit operation level

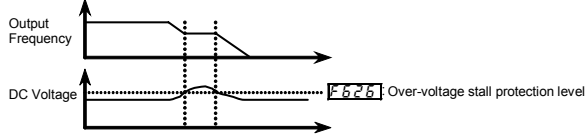

#### [Parameter setting]

Title	Function	Adjustment range	Default setting
<i>F305</i>	Overvoltage limit operation (Deceleration stop mode selection)	0: Enabled 1: Disabled 2: Enabled (Quick deceleration control) 3: Enabled (Dynamic quick deceleration control)	2
<i>F319</i>	Regenerative over-excitation upper limit	100-160 (%)	120*1
<i>F626</i>	Overvoltage stall protection level	100-150 (%) *2	136 (240V class) 141 (500V class)

\*1: Default setting values vary depending on the setup menu setting. Refer to section 11.5.

\*2: 100% corresponds to an input voltage of 200V for 240V models or to an input voltage of 400V for 500V models.

- ★ If *F305* is set to 2 (quick deceleration control), the inverter will increase the voltage to the motor (over-excitation control) to increase the amount of energy consumed by the motor when the voltage reaches the overvoltage protection level during deceleration, and therefore the motor can be decelerated more quickly than normal deceleration.
- ★ If *F305* is set to 3 (dynamic quick deceleration control), the inverter will increase the voltage to the motor (over-excitation control) to increase the amount of energy consumed by the motor as soon as the motor begins to decelerate, and therefore the motor can be decelerated still more quickly than quick deceleration.
- ★ During overvoltage limit operation, the overvoltage pre-alarm (*P* blinks) is displayed.
- ★ The parameter *F319* is used to adjust the maximum energy that the motor consumes during deceleration. Specify a larger value if the inverter trips during deceleration because of an overvoltage. When *F305* is set 2 or 3, this function works.
- ★ Parameter *F626* serves also as a parameter for setting the regenerative braking level.

Output voltage limitation: Limits the voltage at frequencies exceeding the base frequency ( $\omega L \omega$ ) to prevent outputting the voltage exceeding base frequency voltage ( $\omega L \omega$ ).  
 Applied when operating a special motor with low induced voltage.

[Parameter setting]

Title	Function	Adjustment range	Default setting
$\omega L \omega$	Base frequency voltage1	50-330 (240V class) 50-660 (500V class)	*1
$F 3 0 7$	Supply voltage correction (output voltage limitation)	0: Supply voltage uncorrected, output voltage limited 1: Supply voltage corrected, output voltage limited 2: Supply voltage uncorrected, output voltage unlimited 3: Supply voltage corrected, output voltage unlimited	*1

\*1: Default setting values vary depending on the setup menu setting. Refer to section 11.5.

- ★ If  $F 3 0 7$  is set to "0" or "2", the output voltage will change in proportion to the input voltage.
- ★ Even if the base frequency voltage ( $\omega L \omega$  parameter) is set above the input voltage, the output voltage will not exceed the input voltage.
- ★ The ratio of voltage to frequency can be adjusted according to the rated motor voltage and frequency. Setting  $F 3 0 7$  to "0" or "1" prevents the output voltage from increasing, even if the input voltage changes when operation frequency exceeds the base frequency.
- ★ When the V/F control mode selection parameter ( $P 1$ ) is set to any number between 2 to 6, the supply voltage is corrected regardless of the setting of  $F 3 0 7$ .

0 Output frequency  $\omega_L$

\* The above is applied when V/F control mode selection parameter  $P_{\omega}$  is set to "0" or "1".

$\frac{\omega_L}{\text{Rated voltage}} > 1$  the output voltage can be prevented from exceeding the input voltage.

0 Output frequency  $\omega_L$

[F307=2: No voltage compensation/no output voltage limit]

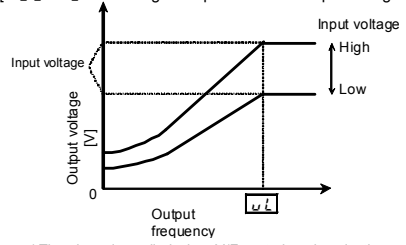

\* The above is applied when V/F control mode selection parameter  $P_{\omega}$  is set to "0" or "1".

$\frac{\omega_L}{\text{Rated voltage}} > 1$  the output voltage can be prevented from exceeding the input voltage.

[F307=3: Voltage compensation/no output voltage control]

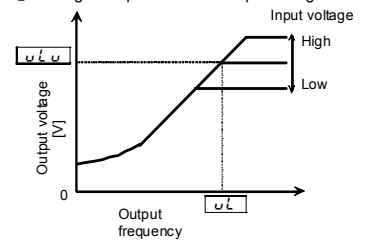

\* Note that even if the input voltage is set less than  $\omega_L$ , an output voltage over  $\omega_L$  occurs for a base frequency of  $\omega_L$  or higher output frequency.

Note: Rated voltage is fixed at 200V for 240V class and 400V for 500V class.

6



[Parameter setting]

Title	Function	Adjustment range	Default setting
<i>F311</i>	Reverse-run prohibition	0: Forward/reverse run permitted 1: Reverse run prohibited 2: Forward run prohibited	0

## 6.20 Drooping control

---

***F320***: Droop gain

***F323***: Droop insensitive torque band

***F324***: Droop output filter

- Function

Drooping control has the function to prevent loads from concentrating at a specific motor because of a load imbalance when multiple inverters are used to operate one machine.

These parameters are used to allow the motor to "slip" according to the load torque current. The insensitive torque band and the gain can be adjusted using these parameters.

[Parameter setting]

Title	Function	Adjustment range	Default setting
<i>F320</i>	Droop gain	0.0-100.0 (%)	0.0
<i>F323</i>	Droop insensitive torque band	0-100 (%)	10
<i>F324</i>	Droop output filter	0.1-200.0	100.0

★ The drooping control function is to operate the power-running motor at operating frequency  $f_1$  (Hz), which is lower than command frequency  $f_0$  (Hz) by droop frequency  $\Delta f$  (Hz), when the torque current is  $T_1$  (%). (See the figure above.)

- The droop frequency  $\Delta f$  can be calculated using the following expression.  
Droop frequency  $\Delta f$  (Hz) = base frequency  $[f_b]$   $\times$   $F_{\text{droop}} \times (T_1 - F_{\text{ins}})$
- When the torque current is above the specified droop insensitive torque band ( $F_{\text{ins}}$ ), the frequency is reduced during power running or increased during regenerative braking. The figure above shows an example of the operating frequency during power running. During regenerative braking, control is performed to increase the frequency.
- The drooping control function is activated above the torque current set with  $F_{\text{act}}$ .
- The amount of droop frequency  $\Delta f$  varies depending on the amount of torque current  $T_1$ .

Note: If the base frequency  $f_b$  exceeds 100Hz, count it as 100Hz.

Control is exercised between the starting frequency ( $F_{\text{st}}$ ) and the maximum frequency ( $F_H$ ).

[An example of calculation]

Parameter setting: Base frequency  $f_b = 60$  (Hz), droop gain  $F_{\text{droop}} = 10$  (%)

Droop insensitive torque band  $F_{\text{ins}} = 30$  (%)

Droop frequency  $\Delta f$  (Hz) and operating frequency  $f_1$  when command frequency  $f_0$  is 50 (Hz) and torque current  $T_1$  is 100 (%) are as follows;

$$\begin{aligned} \text{Droop frequency } \Delta f \text{ (Hz)} &= f_b \times F_{\text{droop}} \times (T_1 - F_{\text{ins}}) \\ &= 60 \text{ (Hz)} \times 10 \text{ (\%)} \times (100 \text{ (\%)} - 30 \text{ (\%)}) \\ &= 4.2 \text{ (Hz)} \end{aligned}$$

$$\text{Operation frequency } f_1 \text{ (Hz)} = f_0 - \Delta f = 50 \text{ (Hz)} - 4.2 \text{ (Hz)} = 45.8 \text{ (Hz)}$$

- F331**: Light-load high-speed operation frequency
- F332**: Light-load high-speed operation load waiting time
- F333**: Light-load high-speed operation load detection time
- F334**: Light-load high-speed operation heavy load detection time
- ⇒ Refer to "Functions for lift application: E6581871" for details.
- operation frequency constant power running
- F338**: Switching load torque during regenerative braking

---

## 6.22 Braking function

---

### 6.22.1 Brake sequence control

- F325**: Brake releasing waiting time
- F326**: Brake releasing small current detection level
- F340**: Creeping time 1
- F341**: Braking mode selection
- F342**: Load portion torque input selection
- F343**: Hoisting torque bias input
- F344**: Lowering torque bias multiplier
- F345**: Brake release time
- F346**: Creeping frequency
- F347**: Creeping time 2
- F348**: Braking time learning function

⇒ Refer to "Functions for lift application: E6581871" for details.

## 0.20 Acceleration/deceleration suspend function (Dwell function)

**F349** : Acceleration/deceleration suspend function  
**F352** : Deceleration suspend frequency

**F350** : Acceleration suspend frequency  
**F353** : Deceleration suspend time

**F351** : Acceleration suspend time

6

### • Function

This function suspends acceleration and deceleration when starting and stopping during the transportation of heavy load by temporarily running the motor at a constant speed according to the delay in braking. It also prevents the occurrence of overcurrent at starting and slippage at stopping by fixing the timing with brake.

There are two ways to suspend acceleration or deceleration: suspending it automatically by setting the suspend frequency and time using parameters, and suspending it by means of a signal from an external control device.

### [Parameter setting]

Title	Function	Adjustment range	Setting value
<b>F349</b>	Acceleration/deceleration suspend function	0:Disabled 1:Parameter setting 2:Terminal input	0
<b>F350</b>	Acceleration suspend frequency	0.0- <i>F<sub>H</sub></i> (Hz)	0.0
<b>F351</b>	Acceleration suspend time	0.0-10.0 (s)	0.0
<b>F352</b>	Deceleration suspend frequency	0.0- <i>F<sub>H</sub></i> (Hz)	0.0
<b>F353</b>	Deceleration suspend time	0.0-10.0 (s)	0.0

Note1: The acceleration suspend frequency (**F350**) should not be set below the starting frequency (**F240**).

Note2: The deceleration suspend frequency (**F352**) should not be set below the stop frequency (**F243**).

Note3: If the output frequency is lowered by a stall prevention function, the acceleration suspend function may be activated.

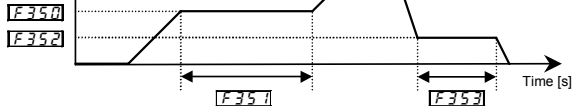

2) To suspend acceleration or deceleration by means of a signal from an external control device

Set  $\text{F} 115$  for an input terminal. As long as ON signals are inputted, the motor continues to rotate at a constant speed.

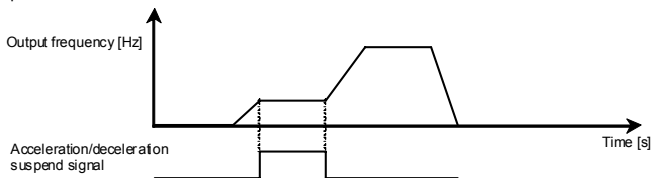

Ex.) When setting the acceleration/deceleration suspend signal to S3 terminal

Title	Function	Adjustment range	Example of setting
$F 115$	Input terminal selection 6 (S3)	0-203	60 (Acceleration/ deceleration suspend signal)

Function No. 61 is the inversion signal.

Note: If the operation signal is ON after Acceleration/ deceleration suspend signal is ON, the inverter will operate at frequency set with  $F 240$ .

■ If the stall control function is activated during constant-speed rotation

The frequency changes momentarily as a result of stall control, but the time for which the frequency changes is included in the suspend time.

### ■ Stall control

The inverter will automatically change the operation frequency when it detects an overcurrent, overload or overvoltage. Configure each stall control setting using the following parameters.

Overcurrent stall : *F 60 1* (Stall prevention level 1)

Overload stall : *OLN* (Electronic thermal protection characteristic selection)

Overvoltage stall : *F 305* (Overvoltage limit operation)

Note: When the frequency command value, the acceleration suspend frequency (*F 350*), and the deceleration suspend frequency (*F 352*) have the same setting, the acceleration/ deceleration suspend function will not work.

## 6.24 PID control

<i>F P 1 d</i> : Process input value of PID control	<i>F 368</i> : Process lower limit
<i>F 167</i> : Frequency command agreement detection range	<i>F 369</i> : PID control feedback signal selection
<i>F 359</i> : PID control waiting time	<i>F 372</i> : Process increasing rate (speed type PID control)
<i>F 360</i> : PID control	<i>F 373</i> : Process decreasing rate (speed type PID control)
<i>F 361</i> : Delay filter	<i>F 380</i> : PID forward/reverse characteristics selection
<i>F 362</i> : Proportional gain	<i>F 389</i> : PID control reference signal selection
<i>F 363</i> : Integral gain	
<i>F 366</i> : Differential gain	
<i>F 367</i> : Process upper limit	

<i>F 3 1 8</i>	Process input value of PID control	<i>F 3 6 8</i> - <i>F 3 6 7</i> (Hz)	0.0
<i>F 3 5 9</i>	PID control waiting time	0-2400 (s)	0
<i>F 3 6 0</i>	PID control	0: Disabled 1: Process type PID control 2: Speed type PID control	0
<i>F 3 6 1</i>	Delay filter	0.0-25.0 (s)	0.1
<i>F 3 6 2</i>	Proportional gain	0.01-100.0	0.30
<i>F 3 6 3</i>	Integral gain	0.01-100.0	0.20
<i>F 3 6 6</i>	Differential gain	0.00-2.55	0.00
<i>F 3 6 7</i>	Process upper limit	0.0- <i>F H</i> (Hz)	60.0 *1
<i>F 3 6 8</i>	Process lower limit	0.0- <i>F 3 6 7</i> (Hz)	0.0
<i>F 3 6 9</i>	PID control feedback signal selection	0: Disabled 1: Terminal VIA 2: Terminal VIB 3: Terminal VIC 4 to 6: -	0
<i>F 3 7 2</i>	Process increasing rate (speed type PID control)	0.1-600.0 (s)	10.0
<i>F 3 7 3</i>	Process decreasing rate (speed type PID control)	0.1-600.0 (s)	10.0
<i>F 3 8 0</i>	PID forward/reverse characteristics selection	0: Forward 1: Reverse	0
<i>F 3 8 9</i>	PID control reference signal selection	0: fmod/f207 selected 1: Terminal VIA 2: Terminal VIB 3: fpid 4: RS485 communication 5: UP/DOWN from external logic input 6: CANopen communication 7: Communication option 8: Terminal VIC 9, 10: - 11: Pulse train input	0

\*1: Default setting value vary depending on the setup menu setting. Refer to section 11.5.

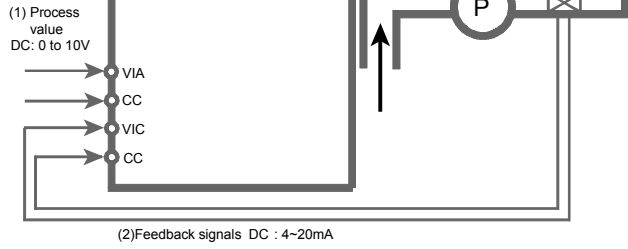

## 2) Selecting process value and feedback value

Process value (frequency) and feedback value can be combined as follows for the PID control.

(1) Process value	(2) Feedback value
PID control reference signal selection <i>F 3 8 9</i>	PID control feedback signal selection <i>F 3 6 9</i>
0: <i>F 0 0 d / F 2 0 7</i> selected 1: Terminal VIA 2: Terminal VIB 3: <i>F P i d</i> 4: RS485 communication 5: UP/DOWN from external logic input 6: CANopen communication 7: Communication option 8: Terminal VIC 9, 10: - 11: Pulse train input	0: Disabled 1: Terminal VIA 2: Terminal VIB 3: Terminal VIC 4 to 6: -

Note 1: When setting *F 3 8 9*, do not select the same signal used for feedback input.

Note 2: When *3* is selected at *F 3 8 9*, the amount of processing will be the value set at *F P i d*.

Value of *F P i d* can be set or changed during operation with the use of setting dial, and then saved in *F P i d*. Please note that this value is not for *F 1* setting (panel operation frequency).

Note 3: Signal is put out when the amount of feedback matches to the amount of processing. Assign function number 144 or 145 to an output terminal.



Note 4: Assigning the function number 36 (PID control prohibition) to an input terminal. PID control function is stopped temporarily while the terminal is ON.

#### 4) Adjusting the PID control gain level

Adjust the PID control gain level according to the process quantities, the feedback signals and the object to be controlled.

[Parameter settings]

Title	Function	Adjustment range	Default setting
<i>F 362</i>	Proportional gain (P)	0.01 - 100.0	0.30
<i>F 363</i>	Integral gain (I)	0.01 - 100.0 (1/s <sup>-1</sup> )	0.20
<i>F 366</i>	Derivative gain (D)	0.00 - 2.55 (s)	0.00

#### *F 362* (P-gain adjustment parameter)

This parameter adjusts the proportional gain level during PID control. A correction value proportional to the particular deviation (the difference between the process value and the feedback value) is obtained by multiplying this deviation by the parameter setting.

A larger P-gain adjustment value gives faster response. Too large an adjustment value, however, results in an unstable event such as hunting.

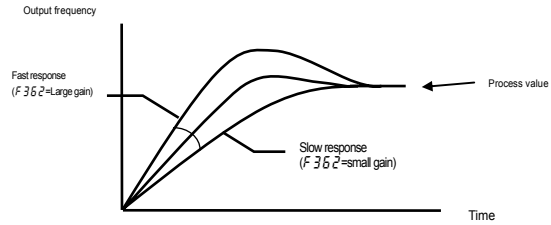

6

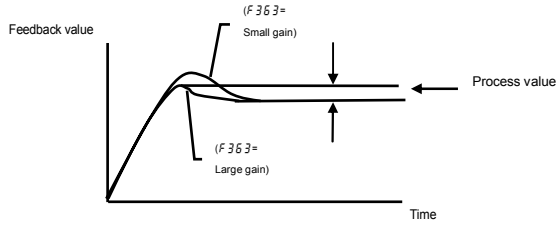

- ★ Assign function number 52 (PID integral/derivative clear) to an input terminal. It is possible to calculate integral/derivative amounts always as 0 (zero) while the input terminal is ON.

### F 365 (D-gain adjustment parameter)

This parameter adjusts the differential gain level during PID control. This gain increases the speed of response to a rapid change in deviation (difference between the process value and the feedback value). Note that setting the gain beyond necessity may cause fluctuations in output frequency, and thus operation to become unstable.

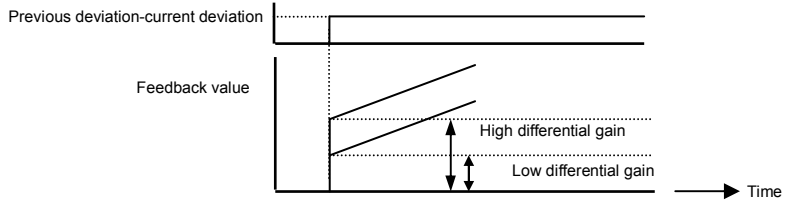

- ★ Assign function number 52 (PID integral/derivative clear) to an input terminal, and it is possible to calculate integral/derivative amounts always as 0 (zero) while the input terminal is ON.

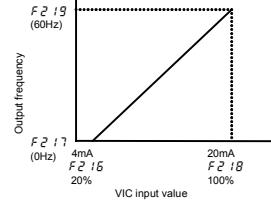
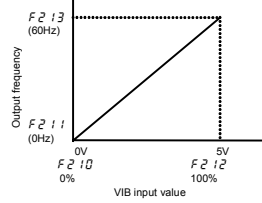
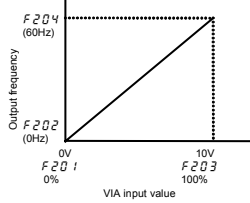

### 6) Setting the time elapsed before PID control starts

Waiting time until starting PID control system can be set to avoid PID control until the control system becomes stable.

The inverter ignores feedback input signals, carries out operation at the frequency determined by the amount of processing for the period of time specified with  $F359$ , and enters the PID control mode after the elapsed time.

### 7) PID control forward/reverse characteristic switch

PID input characteristics can be reversed.

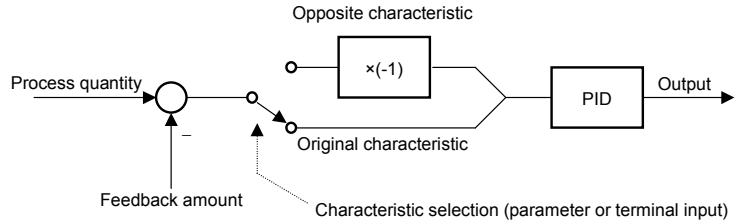

- When characteristic is reversed according to parameters, set PID calculation reverse selection parameter  $F380$  is 1: Set reverse characteristics.
- When characteristic is reversed using logic input terminal, assign function number 54/55, PID characteristics switching, to an input terminal.

Note) If reverse characteristics is selected for parameter  $F380$  and terminal input at the same time,

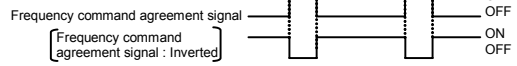
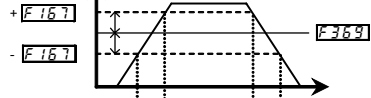

6

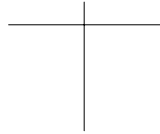
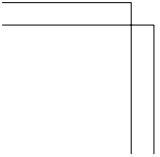
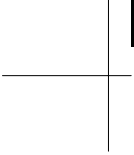

F402: Automatic torque boost value

F453: Load inertia moment ratio

F405: Motor rated capacity

F462: Speed reference filter coefficient

F415: Motor rated current

To use vector control, automatic torque boost and automatic energy saving, motor constant setting (motor tuning) is required. The following three methods are available to set motor constants.

- 1) Using the torque boost setting macro function (RU2) for setting the V/F control mode selection (PE) and auto-tuning (F400=2) collectively
- 2) Setting V/F control mode selection (PE) and auto-tuning (F400) independently
- 3) Combining the V/F control mode selection (PE) and manual tuning

Caution:

If the settings for V/F control mode selections PE are 2: automatic torque boost control, 3: vector control, 4: energy-saving, and 5: Dynamic energy-saving, make sure to confirm the motor's name plate and set the following parameters;

UL: Base frequency 1 (rated frequency)

ULV: Base frequency voltage 1 (rated voltage)

F405: Motor rated capacity

F415: Motor rated current

F417: Motor rated speed

Set the other motor constants as necessary.

[Selection 1: Setting by parameter setting macro torque boost]

This is the easiest among the available methods. It conducts vector control and auto-tuning at the same time. Be sure to set the motor for UL, ULV, F405, F415, F417.

Set RU2 to 1 (Automatic torque boost + auto-tuning)

Set RU2 to 2 (Vector control + auto-tuning)

Set RU2 to 3 (Energy-saving + auto-tuning)

Refer to section 6.1 for details of the setting method.

Prm	Function	Adjustment Range	Default Setting
F400	Auto-tuning	0: Auto-tuning disabled 1: Initialization of F402 (after execution : 0) 2: Auto-tuning executed (after execution: 0) 3: - 4: Motor constant auto calculation (after execution: 0) 5: 4+2 (after execution: 0)	0

Set F400 to 2 before the start of operation. Auto-tuning is performed at the start of the motor and set F402, F412.

6

★ Precautions on auto-tuning

- (1) Conduct auto-tuning after the motor has been connected properly and operation completely stopped.  
If auto-tuning is conducted immediately after operation stops, the presence of a residual voltage may result in abnormal tuning.
- (2) Voltage is applied to the motor during tuning even though it barely rotates. During tuning, "Rt n" is displayed on the operation panel.
- (3) Tuning is performed when the motor starts for the first time after F400 is set to 2.  
Tuning is usually completed within three seconds. If it is aborted, the motor will trip with the display of Et n / and no constants will be set for that motor.
- (4) High-speed motors, high-slip motors or other special motors cannot be auto-tuned. For these motors, perform manual tuning using Selection 3 described below.
- (5) Provide cranes and hoists with sufficient circuit protection such as mechanical braking. Insufficient motor torque while tuning may cause machine stalling/falling.
- (6) If auto-tuning is impossible or an "Et n /" auto-tuning error is displayed, perform manual tuning with selection 4.

[Selection 3: Setting vector control and motor constant automatically]

After setting uL, uLv, F405, F415 and F417, motor constants calculated automatically.  
F402, F412 and F416 are set automatically.

Set the motor constant parameter F400 to 4 (auto calculation)

Set F400=5, when auto-tuning is executed after setting motor constants automatically.

<i>F 4 0 5</i>	Motor rated capacity	0.01-22.00 (kW)	the capacity (Refer to section 11.4)
<i>F 4 1 5</i>	Motor rated current	0.1-100.0 (A)	
<i>F 4 1 6</i>	Motor no-load current	10-90 (%)	
<i>F 4 1 7</i>	Motor rated speed	100-64000 (min <sup>-1</sup> )	*1
<i>F 4 5 9</i>	Load inertia moment ratio	0.1-100.0 (times)	1.0
<i>F 4 6 2</i>	Speed reference filter coefficient	0-100	35
<i>t H r</i>	Motor electronic thermal protection level 1	10-100 (%) / (A)	100

\*1: Default setting values vary depending on the setup menu setting. Refer to section 11.5.

Setting procedure Adjust the following parameters:

- F 4 0 1*: Set the compensation gain for the slipping of the motor. A higher slip frequency reduces motor slipping correspondingly. After setting *F 4 1 7*, set *F 4 0 1* for fine adjustment. Be careful as inputting a value larger than necessary causes hunting and other unstable operation.
- F 4 0 2*: Adjust the primary resistive component of the motor. Torque reduction due to possible voltage drop during low-speed operation can be suppressed by setting a large value in this parameter. Be careful as setting a value larger than necessary may lead to an increased current and then cause a trip at low speeds. (Perform adjustments according to the actual operation.)
- F 4 0 5*: Set the motor's rated capacity according to the motor's name plate or test report.
- F 4 1 5*: Set the rated current of the motor. For the rated current, see the motor's nameplate or test report.
- F 4 1 6*: Set the ratio of the no-load current of the motor to the rated current. Enter the value in % that is obtained by dividing the no-load current specified in the motor's test report by the rated current. A larger value increases the excitation current.
- F 4 1 7*: Set the rated rotational speed of the motor. For the rated current, see the motor's nameplate or test report.
- ★ Adjustment method for the moment of inertia of the load
- F 4 5 9*: Adjusts the excess response speed. A larger value gives a smaller overshoot at the acceleration/deceleration completion point. In the default settings, the moment of inertia of the load (including the motor shaft) value is optimally set considering a motor shaft of 1x. When the moment of inertia of the load is not 1x, set a value that matches that actual moment of inertia of the load.
- t H r*: If the rated capacity of the motor is one size smaller than that of the inverter, lower the thermal protective level according to the rated current of the motor.

**Caution:**

If a combination of the inverter rating and the motor capacity is different for more than 2 classes, vector control may not operate correctly.

**F417**: Motor rated speed

**F459**: Load inertia moment ratio

Caution:

If the settings for V/F control mode selections  $P\tau = 5$ : vector control for PM motor  
Look at the motor's name plate and set the following parameters.

- $\omega L$ : Base frequency 1 (rated frequency) that is calculated from Back EMF
- $\omega L V$ : Base frequency voltage 1 (rated voltage) that is calculated from Back EMF
- F405**: Motor rated capacity
- F415**: Motor rated current
- F417**: Motor rated speed
- F912**: Q axis inductance per phase
- F913**: D axis inductance per phase

6

[Selection 1: Setting PM motor control and auto-tuning ]

After setting  $P\tau = 5$ , auto-tuning occurs.

Set the auto-tuning parameter **F400** to 2 (Auto-tuning enabled)

[Parameter setting]

Title	Function	Adjustment range	Default setting
<b>F400</b>	Auto-tuning	0: Auto-tuning disabled 1: Initialization of <b>F402</b> , <b>F912</b> , <b>F913</b> (after execution : 0) 2: Auto-tuning executed (after execution: 0) 3: - 4: - 5: -	0

Note1) When parameter  $P\tau = 5$  is selected, **F400=3** to **5** do not work.



- Tuning is usually completed within three seconds. If it is aborted, the motor will trip with the display of  $E \text{ } \epsilon \text{ } n \text{ } i$  and no constants will be set for that motor.
- (4) If special motors cannot be auto-tuned, perform manual tuning follow Selection 2 described below.
  - (5) Provide cranes and hoists with sufficient circuit protection such as mechanical braking. Insufficient motor torque while tuning may cause machine stalling/falling.
  - (6) If auto-tuning is impossible or an " $E \text{ } \epsilon \text{ } n \text{ } i$ " auto-tuning error is displayed, perform manual tuning with Selection 2.

### [Selection 2: Setting PM motor control and manual tuning]

If an " $E \text{ } \epsilon \text{ } n \text{ } i$ " tuning error is displayed during auto-tuning or when PM motor control characteristics are to be improved, set motor constants manually.

[Parameter setting]

Title	Function	Adjustment range	Default setting
$F 4 0 2$	Automatic torque boost value	0.1-30.0 (%)	Depends on the capacity (Refer to section 11.4)
$F 4 0 5$	Motor rated capacity	0.01-22.00 (kW)	
$F 4 1 5$	Motor rated current	0.1-100.0 (A)	
$F 4 1 7$	Motor rated speed	100-64000 ( $\text{min}^{-1}$ )	*1
$F 4 5 9$	Load inertia moment ratio	0.1-100.0 (times)	1.0
$F 4 6 2$	Speed reference filter coefficient	0-100	35
$F 9 1 2$	Q axis inductance per phase	0.01-650.0 (mH)	10.00
$F 9 1 3$	D axis inductance per phase	0.01-650.0 (mH)	10.00
$\epsilon H r$	Motor electronic thermal protection level 1	10-100 (%) / (A)	100

\*1: Default setting values vary depending on the setup menu setting.

Setting procedure Adjust the following parameters:

$F 4 0 2$ : Adjust the primary resistive component of the motor. Decreases in torque due to a possible voltage drop during low-speed operation can be suppressed by setting a large value in this parameter. Be careful as setting a value larger than necessary may lead to an increased current causing a trip at low speeds. (Perform adjustments according to the actual operation.) If the test report exists, see the stator resistance value per phase.

$$F 4 0 2 = \sqrt{3} \times R_s \times F 4 1 5 / V_{type} \times 100 [\%]$$

$R_s$  is Stator resistance per phase [ohm]  $V_{type}$  is 200 or 400 [V] (depend on voltage class)

moment of inertia of the load is not 1X, set a value that matches that actual moment of inertia of the load.

$\xi Hr$  : If the rated capacity of the motor is one size smaller than that of the inverter, lower the thermal protective level according to the rated current of the motor.

\* Sensorless vector control may not operate properly if the motor capacity differs from the applicable rated capacity of the inverter by more than two grades.

Caution:

If a combination of the inverter rating and the motor capacity is different for more than 2 items, PM motor control may not operate correctly.



6

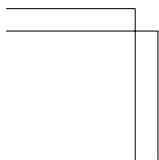

**F444**: Power running torque limit 2 level

• **Function**

Decrease the output frequency according to the overload condition when the motor torque reaches a certain set level. This function will be invalid when setting a torque limit parameter at 250. You can also select limiting the constant output or constant torque in the constant output zone. This function will not work when the parameter  $P\tau=0, 1, 7$  setting.

■ **Setting methods**

When setting limits to torque, use internal parameters (Torque limits can also be set with an external control device.)

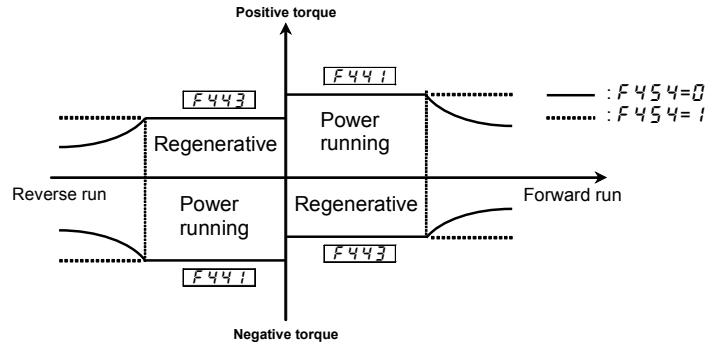

With the parameter  $F454$ , you can select the item for limit treatment in the constant output zone (somewhat weak magnetic field) from constant output ( $F454=0$ : default setting) or constant torque ( $F454=1$ ). Output voltage limit option ( $F307=1$ ) is recommended for the parameter  $F307$  (supply voltage correction).

F 4 5 4	Constant output zone torque limit selection	0: Constant output limit 1: Constant torque limit	0
---------	---	--	---

Using parameters, two different torque limits can be set for each operating status: power running and regenerative braking. Refer to Section 7.2.1 for the setting for switching from the terminal board.

Power running torque limit 1 : F 4 4 1

Regenerative braking torque limit 1 : F 4 4 3

Power running torque limit 2 : F 4 4 4

Regenerative braking torque limit 2 : F 4 4 5

Note: If the value set with F 5 0 1 (stall prevention level) is smaller than the torque limit, then the value set with F 5 0 1 acts as the torque limit.

6

## 6.26.2 Torque limit mode selection at acceleration/deceleration

**F 4 5 1** : Acceleration/deceleration operation after torque limit

### •Function

Using this function in combination with the mechanical brake of the lifting gear (such as a crane or hoist) makes it possible to minimize the delay before the brake starts working, and thus prevents the load from falling due to torque decrease.

Moreover, it improves the motor's response during inching operation and keeps the load from sliding down.

[Parameter setting]

Title	Function	Adjustment range	Default setting
F 4 5 1	Acceleration/deceleration operation after torque limit	0: In sync with acceleration / deceleration 1: In sync with min. time	0

(1) F 4 5 1=0 (In sync with acceleration/deceleration)

The increase in operation frequency is inhibited by the activation of the torque limit function. In this control mode, therefore, the actual speed is always kept in sync with the operation frequency. The operation frequency restarts to increase when torque decreases as a result of the release of the mechanical brake, so the time required for reaching the specified speed is the sum of the delay in operation of the mechanical brake and the acceleration time.

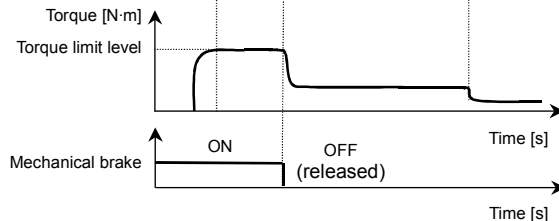

(2)  $F 45 \ i = t$  (In sync with min. time)

The operation frequency keeps increasing, even if the torque limit function is activated.

In this control mode, the actual speed is kept in sync with the operation frequency, while torque is held at a limit level in spite of torque decrease when releasing the mechanical brake. The use of this function prevents the load from failing and improves the motor's response during inching operation.

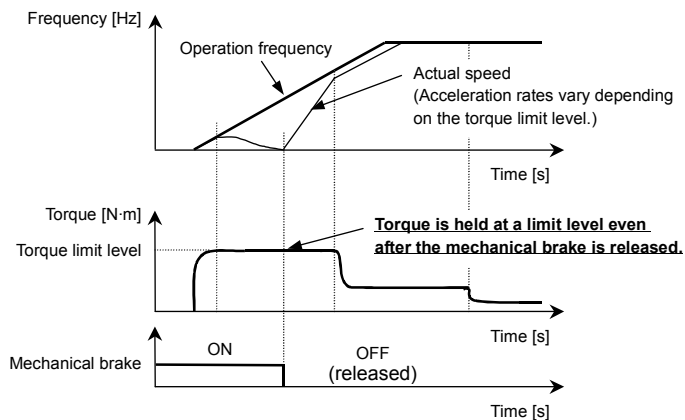

[Parameter setting]

Title	Function	Adjustment range	Default setting
F452	Power running stall continuous trip detection time	0.00-10.00 (s)	0.00
F441	Power running torque limit 1 level	0-249%, 250:Disabled	250
F601	Stall prevention level 1	10-199, 200 (disabled)	150

6

1) In case of overcurrent stall

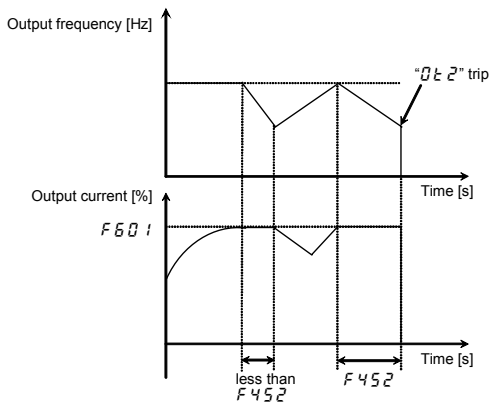

D.L.2 trip is occurred if the output current reached the stall prevention level (F601) or more, and this situation maintain in F452 during power running.

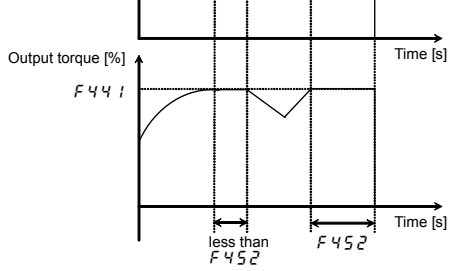

$\bar{U} \bar{t} \bar{2}$  trip is occurred if the output torque reached the power running torque limit level ( $F44 I$ ) or more, and this situation maintain in  $F45 2$  during power running.

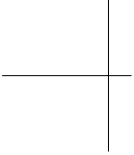

F-95

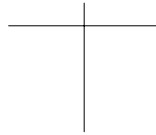
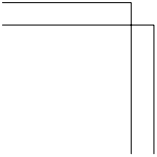

- Function

These parameters allow you to select an acceleration/deceleration pattern that suits the intended use.

Title	Function	Adjustment range	Default setting
F502	Acceleration/ deceleration 1 pattern	0: Linear, 1: S-pattern 1, 2: S-pattern 2	0
F506	S-pattern lower-limit adjustment amount	0-50 (%)	10
F507	S-pattern upper-limit adjustment amount	0-50 (%)	10

6

1) Linear acceleration/deceleration

A general acceleration/ deceleration pattern. This pattern can usually be used.

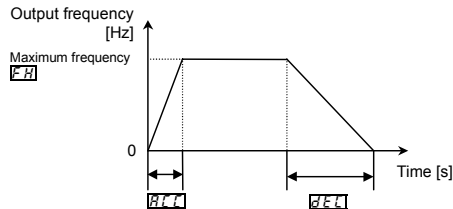

2) S-pattern 1 acceleration/deceleration

Select this pattern to accelerate/decelerate the motor rapidly to a high-speed region with an output frequency of 60Hz or more or to minimize the shocks applied during acceleration/deceleration. This pattern is suitable for pneumatic transport machines.

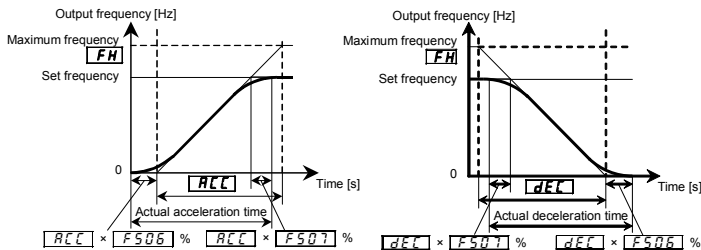



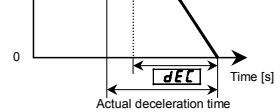
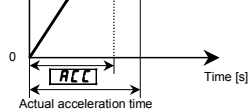

## 6.27.2 Switching of an acceleration/deceleration time 1, 2, 3

**F500**: Acceleration time 2

**F501**: Deceleration time 2

**F503**: Acceleration/deceleration 2 pattern

**F504**: Acceleration/deceleration selection (1,2,3) (panel keypad)

**F505**: Acceleration/deceleration 1 and 2 switching frequency

**F510**: Acceleration time 3

**F511**: Deceleration time 3

**F512**: Acceleration/deceleration 3 pattern

**F513**: Acceleration/deceleration 2 and 3 switching frequency

**F519**: Setting of acceleration/deceleration time unit

- Function

Three different times for acceleration and deceleration can be specified individually. Choose from the following for the method of selection or switching:

- 1) Selection by means of parameters
- 2) Switching by changing frequencies
- 3) Switching by means of terminals

<i>F519</i>	Setting of acceleration/deceleration time unit	1: 0.01s unit (after execution: 0) 2: 0.1s unit (after execution: 0)	0
-------------	--	---	---

★ Default setting is 0.1s unit. Acceleration/deceleration time unit can be changed to 0.01s unit by *F519=1* setting. (The value of *F519* return to 0 after setting.)

1) Selection using parameters

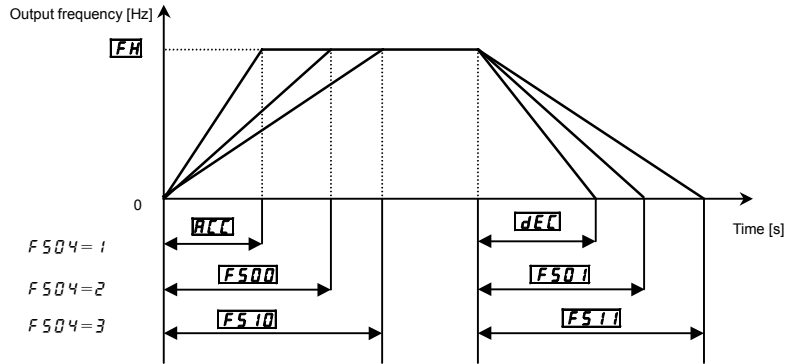

Acceleration/deceleration time 1 is initially set as the default. Acceleration/deceleration time 2 and 3 can be selected by changing the setting of the *F504*.  
Enabled if *EN0d=1* (panel input enabled)

2) Switching by frequencies (Switching the acceleration/deceleration time automatically at the frequency setting of *F505*)

Title	Function	Adjustment range	Default setting
<i>F505</i>	Acceleration/deceleration 1 and 2 switching frequency	0.0 (disabled) 0.1- $\bar{U}L$ (Hz)	0.0
<i>F513</i>	Acceleration/deceleration 2 and 3 switching frequency	0.0 (disabled) 0.1- $\bar{U}L$ (Hz)	0.0

Note: Acceleration/deceleration patterns are changed from pattern 1 to pattern 2 and from pattern 2 to pattern 3 in increasing order of frequency, regardless of the order in which frequencies are changed. (For example, if *F505* is larger than *F513*, *F513* pattern 1 is selected in the frequency range below the frequency set with *F505*.)

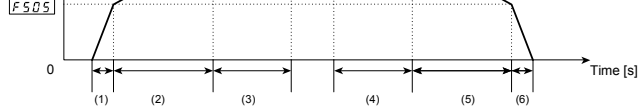

- |   |   |
|---|---|
| (1) Acceleration at the gradient corresponding to acceleration time $R \zeta \zeta$       | (4) Deceleration at the gradient corresponding to deceleration time $F \zeta ! !$     |
| (2) Acceleration at the gradient corresponding to acceleration time $F \zeta \zeta \zeta$ | (5) Deceleration at the gradient corresponding to deceleration time $F \zeta \zeta !$ |
| (3) Acceleration at the gradient corresponding to acceleration time $F \zeta ! \zeta$     | (6) Deceleration at the gradient corresponding to deceleration time $d \zeta \zeta$   |

3) Switching using external terminals (Switching the acceleration/deceleration time via external terminals)

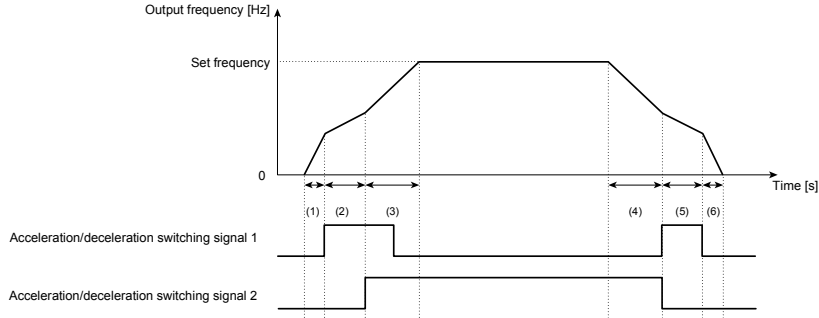

- |   |   |
|---|---|
| (1) Acceleration at the gradient corresponding to acceleration time $R \zeta \zeta$       | (4) Deceleration at the gradient corresponding to deceleration time $F \zeta ! !$     |
| (2) Acceleration at the gradient corresponding to acceleration time $F \zeta \zeta \zeta$ | (5) Deceleration at the gradient corresponding to deceleration time $F \zeta \zeta !$ |
| (3) Acceleration at the gradient corresponding to acceleration time $F \zeta ! \zeta$     | (6) Deceleration at the gradient corresponding to deceleration time $d \zeta \zeta$   |

<i>F 1 15</i>	Input terminal selection 5 (S2)	0-203	24 (the second acceleration/deceleration mode selection)
<i>F 1 16</i>	Input terminal selection 6 (S3)	0-203	26 (the third acceleration/deceleration mode selection)

■ Acceleration/ deceleration pattern

Acceleration/deceleration patterns can be selected individually, using the acceleration/deceleration 1, 2 and 3 parameters.

- 1) Linear acceleration/deceleration
- 2) S-pattern acceleration/deceleration 1
- 3) S-pattern acceleration/deceleration 2

Title	Function	Adjustment range	Setting value
<i>F 5 0 2</i>	Acceleration/ deceleration 1 pattern	0: Linear 1: S-pattern 1 2: S-pattern 2	0
<i>F 5 0 3</i>	Acceleration/ deceleration 2 pattern		0
<i>F 5 1 2</i>	Acceleration/ deceleration 3 pattern		0

- ★ For an explanation of acceleration/deceleration patterns, see 6.23.1.
- ★ Both the settings of the S-pattern lower-limit and upper-limit adjustment parameters (*F 5 0 6* and *F 5 0 7*) are applied to any acceleration/deceleration S-pattern.

## 6. 28 Shock monitoring function

*F 5 9 0*: Shock monitoring

*F 5 9 1*: Shock monitoring trip/ alarm selection

*F 5 9 2*: Shock monitoring detection direction selection

*F 5 9 3*: Shock monitoring detection level

*F 5 9 5*: Shock monitoring detection time

*F 5 9 6*: Shock monitoring detection hysteresis

*F 5 9 7*: Shock monitoring detection start waiting time

*F 5 9 8*: Shock monitoring detection action selection



⇒ Refer to "Shock monitoring function Instruction Manual: E6581875".

Refer to section 5.6.

## 6.29.2 Setting of stall prevention level

**F601**: Stall prevention level 1

**F185**: Stall prevention level 2

 <b>Caution</b>	
 Prohibited	<ul style="list-style-type: none"> <li>Do not set the stall prevention level (<b>F601</b>) extremely low. If the stall prevention level parameter (<b>F601</b>) is set at or below the no-load current of the motor, the stall preventive function will be always active and increase the frequency when it judges that regenerative braking is taking place. Do not set the stall prevention level parameter (<b>F601</b>) below 30% under normal use conditions.</li> </ul>

- Function

This parameter adjusts the output frequency by activating a current stall prevention function against a current exceeding the **F601**-specified level.

[Parameter setting]

Title	Function	Adjustment range	Default setting
<b>F601</b>	Stall prevention level 1	10-199 (%) / (A), 200: Disabled	150
<b>F185</b>	Stall prevention level 2		

[Display during operation of the stall prevention]

During an **OL** alarm status, (that is, when there is a current flow in excess of the stall prevention level), the output frequency changes. At the same time, to the left of this value, "L" is displayed flashing on and off.

Example of display

**L 50**

★ The switching from **F601** to **F185** can be performed by entering a command through terminals. Refer to section 6.4.1 for details.

Note: The 100% standard value is the rated output current indicated on the nameplate.

Title	Function	Adjustment range	Default setting
F502	Inverter trip retention selection	0: Cleared with power off 1: Retained with power off	0

- ★ The causes of up to eight trips that occurred in the past can be displayed in status monitor mode. (Refer to section 8.3)
  - ★ Data displayed in status monitor mode when the inverter is tripped is cleared when power is turned off. Check the details monitor for the history of past trips. (Refer to section 8.2.2)
  - ★ Trip records are retained even if power is turned off and turned back on during retry operation.
- Flow of operation when F502=1

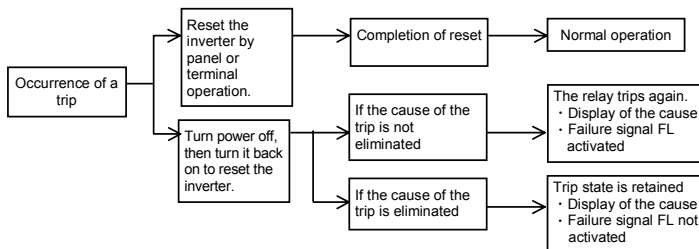

## 6.29.4 Emergency stop

**F515**: Deceleration time at emergency stop

**F603**: Emergency stop selection

**F604**: DC braking time during emergency stop

- Function

Set the stop method for an emergency. When operation stops, a trip occurs (E displays) and failure signal FL operates.

When F603 is set to 2 (Emergency DC braking), set F251 (DC braking amount) and F604 (DC braking time during emergency stop).

When F603 is set to 3 (Deceleration stop), set F515 (Deceleration time at emergency stop).

<i>F 6 0 3</i>	Emergency stop selection	2: Emergency DC braking 3: Deceleration stop ( <i>F 5 1 5</i> ) 4: Quick deceleration stop 5: Dynamic quick deceleration stop	0
<i>F 6 0 4</i>	DC braking time during emergency stop	0.0-20.0 (s)	1.0
<i>F 2 5 1</i>	DC braking current	0 - 100 (%)	50

Setting example) When assigning the emergency stop function to S2 terminal

Title	Function	Adjustment range	Setting
<i>F 1 1 4</i>	Input terminal selection 4A (S1)	0 - 203	20: EXT (Emergency stop by external signal)

Setting value 21 is reverse signal.

Note 1) Emergency stopping via the specified terminal is possible, even during panel operation.

## 2) Emergency stop from the operation panel

Emergency stop from the operation panel is possible by pressing the STOP key on the panel twice while the inverter is not in the panel control mode.

(1) Press the STOP key ..... "E F F" will blink.

(2) Press the STOP key once again ..... Operation will come to a trip stop in accordance with the setting of the *F 6 0 3* parameter.

After this, "E" will be displayed and a failure detection signal generated (FL relay is activated).

Note: While an emergency stop signal is input at a terminal, the trip cannot be reset. Clear the signal and then reset the trip.

Set  $F605$  to  $5$  to open the motor-inverter connection by switching commercial power operation to inverter operation.

Detection errors may occur for special motors such as high-speed motors.

$F605=0$ : No tripping. (Failure signal FL not activated)

$F605=1$ : With the power on, the output phase failure will be detected when the first operation starts.

The inverter will trip if the phase failure status persists for one second or more. (Failure signal FL activated)

$F605=2$ : The inverter checks for output phase failures every time the operation starts. The inverter will trip if the phase failure status persists for one second or more. (Failure signal FL activated)

$F605=3$ : The inverter checks for output phase failures during operation. The inverter will trip if the phase failure status persists for one second or more. (Failure signal FL activated)

$F605=4$ : The inverter checks for output phase failures at the start and during operation. The inverter will trip if the phase failure status persists for one second or more. (Failure signal FL activated)

$F605=5$ : If the inverter detects an all-phase failure, it will restart on completion of reconnection. The inverter does not check for output phase failures when restarting after a momentary power failure. (Failure signal FL not activated)

[Parameter setting]

Title	Function	Adjustment range	Default setting
$F605$	Output phase failure detection selection	0: Disabled 1: At start-up (only one time after power on) 2: At start-up (each time) 3: During operation 4: At start-up + during operation 5: Detection of cutoff on output side	0

Note1) A check for output phase failures is made during auto-tuning, regardless of the setting of this parameter.

Note2) When parameter  $P\tau=5$  or  $6$  is selected,  $F605=3$  to  $5$  do not work.



when the motor capacity is smaller than the inverter capacity.

If the power capacity is larger than the inverter capacity (more than 500kVA or more than 10 times), detection errors may occur. If this actually happens, install an AC reactor .

$F\delta\delta\delta=0$ : No tripping. (Failure signal FL not activated)

$F\delta\delta\delta=1$ : Phase failure detection is enabled during operation. The inverter will trip if the abnormal voltage status of main circuit capacitor persists for few minutes or more. (Failure signal FL activated)

[Parameter setting]

Title	Function	Adjustment range	Default setting
$F\delta\delta\delta$	Input phase failure detection selection	0: Disabled 1: Enabled	1

Note1: Setting  $F\delta\delta\delta$  to 0 (input phase failure detection: disabled) may result in a breakage of the capacitor in the inverter main circuit if operation is continued under a heavy load in spite of the occurrence of an input phase failure.

Note2: Parameter  $F\delta\delta\delta$  is invalid for single-phase input model.

Note3: When operating the inverter with DC input, set  $F\delta\delta\delta=0$  (none).

- Function

If the output current falls below the value set at  $F611$  and doesn't return above  $F611+F609$  for a time that exceeds the value set at  $F612$ , tripping or output alarm will be activated.  
 $UC$  is displayed in the event of a trip.

$F610=0$ : No tripping. (Failure signal FL not activated)

A small current alarm can be put out from the output terminal.

$F610=1$ : The inverter will trip if a current below the current set with  $F611$  flows for the period of time specified with  $F612$ . (Failure signal FL activated)

[Parameter setting]

Title	Function	Adjustment range	Default setting
$F609$	Small current detection hysteresis	1-20 (%)	10
$F610$	Small current trip/alarm selection	0: Alarm only 1: Tripping	0
$F611$	Small current detection current	0-150 (%) / (A)	0
$F612$	Small current detection time	0-255 (s)	0

<Example of operation>

Output terminal function: 26 (UC) Low current detection

$F610=0$  (Alarm only)

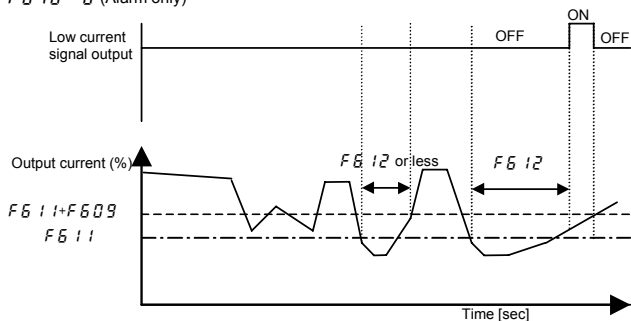

\* When setting  $F610$  to 1 (Trip), trip after low current is detected for the period of time set with  $F612$ . After tripping, the low current signal remains ON.

$F 6 13=0$ : Detection is executed in the length of the standard pulse every time you start up the inverter.  
 $F 6 13=1$ : Detection is executed in the length of standard pulse only during the first start-up after putting on the power or after resetting.

$F 6 13=2$ : Detection is executed with the short-time pulse every time you start up the inverter.

$F 6 13=3$ : Detection is executed with the short-time pulse only for the first time after putting power on or after resetting.

[Parameter setting]

Title	Function	Adjustment range	Default setting
$F 6 13$	Detection of output short-circuit at start-up	0: Each time (standard pulse) 1: Only one time after power on (standard pulse) 2: Each time (short pulse) 3: Only one time after power on (short pulse)	0

## 6.29.9 Ground fault detection function

**$F 6 14$** : Ground fault detection selection

- Function

This parameter detects inverter ground fault. If a ground fault occurs in the inverter unit or output side, the inverter will trip and the failure signal FL will be activated.  $E F 2$  is displayed in the event of a trip.

$F 6 14=0$ : No tripping. (Failure signal FL not activated)

$F 6 14=1$ : Ground fault detection is enabled. The inverter will trip if the ground fault is occurred.  
(Failure signal FL activated)

[Parameter setting]

Title	Function	Adjustment range	Default setting
$F 6 14$	Ground fault detection selection	0: Disabled 1: Enabled	1

Note: When ground fault detection function sets to "Disabled", installing of ground detector such as ground relay is recommended.

- Function

If the torque value exceeds the value set at  $F\check{E} 1\check{E}$  and doesn't return below  $F\check{E} 1\check{E}-F\check{E} 1\check{G}$  for a time that exceeds the value set at  $F\check{E} 1\check{B}$ , tripping or output alarm will be activated.  $\check{G}t$  is displayed in the event of a trip.

$F\check{E} 1\check{S}=0$ : No tripping. (Failure signal FL not activated)

An over-torque alarm can be put out by setting the output terminal function selection parameter.

$F\check{E} 1\check{S}=1$ : The inverter trips when a torque exceeding the  $F\check{E} 1\check{E}$ -specified level has been detected for longer than the  $F\check{E} 1\check{B}$ -specified time. (Failure signal FL activated)

[Parameter setting]

Title	Function	Adjustment range	Default setting
$F\check{E} 1\check{S}$	Over-torque trip/alarm selection	0: Alarm only 1: Tripping	0
$F\check{E} 1\check{E}$	Over-torque detection level	0 (disabled), 1-250 (%)	150
$F\check{E} 1\check{B}$	Over-torque detection time	0.0-10.0 (s) Note	0.5
$F\check{E} 1\check{G}$	Over-torque detection hysteresis	0-100 (%)	10

Note:  $F\check{E} 1\check{B}=0.0$  seconds is the shortest time detected on control.

6

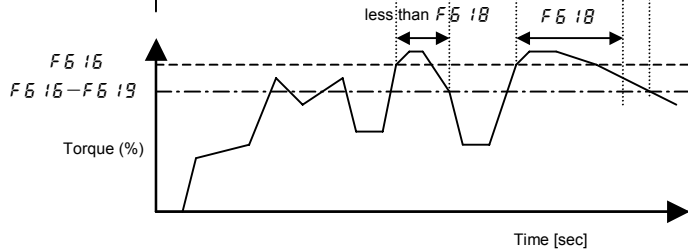

When  $F615 = 1$  (tripping), the inverter will trip if over-torque lasts for the period of time set with  $F618$ . The over-torque signal remains ON.

## 6.29.11 Cooling fan control selection

### **F620**: Cooling fan ON/OFF control

- Function

Operate the cooling fan only when the ambient temperature is high or during operation. This function will extend the service life of the cooling fan than when it is always running while the power is ON.

$F620=0$ : Cooling fan automatically controlled. Cooling fan operates only when the ambient temperature is high during operation.

$F620=1$ : Cooling fan not automatically controlled. The fan is always running when the inverter is on.

★ If the ambient temperature is high, even when the inverter is stopped, the cooling fan automatically operates.

[Parameter setting]

Title	Function	Adjustment range	Default setting
$F620$	Cooling fan ON/OFF control	0: ON/OFF control 1: Always ON	0

Title	Function	Adjustment range	Default setting
<i>F521</i>	Cumulative operation time alarm setting	0.0-999.0 (100 hours)	876.0

★ "0.1" displayed on the monitor refers to 10 hours, and therefore "1.0" denotes 100 hours.

Ex.: 38.5 displayed on the monitor = 3850 (hours)

★ Monitor display of cumulative operation time alarm.

It can be confirmed in parts replacement alarm information of status monitor mode.

An example of display: 

★ Signal output of cumulative operation time alarm

Assign the cumulative operation time alarm function to any output terminal.

Ex.: When assigning the cumulative operation alarm signal output function to the OUT terminal

Title	Function	Adjustment range	Setting
<i>F131</i>	Output terminal selection 2A (OUT)	0-255	56: COT (Cumulative operation time alarm)

Setting value 57 is reverse signal.

★ The cumulative operation time until present time can be checked in status monitor mode.

(Refer to chapter 8)

★ The monitor value of cumulative operation time is reset to 0(zero) by setting  $\text{tYP}=5$  (cumulative operation time clear).

(Refer to section 4.3.2)

## 6.29.13 Undervoltage trip

### *F527*: Undervoltage trip/alarm selection

- Function

This parameter is used for selecting the control mode when an undervoltage is detected. Trip information is displayed as "UP I".

*F527=0*: The inverter is stopped. However, it is not tripped (Failure signal FL not activated).

The inverter is stopped when the voltage does not exceed about 60 % of its rating.

*F527=1*: Inverter is stopped. It is also tripped (Failure signal FL activated), only after detection of a voltage not exceeding about 60% of its rating.

## 6.29.14 Analog input break detection

**F633**: Analog input break detection level (VIC)

**F644**: Operation selection of analog input break detection (VIC)

**F649**: Fallback frequency

- Function

The inverter will trip if the VIC value remains below the specified value for about 0.3 seconds. In such a case, trip "E-18" and alarm "AL05" is displayed.

F633=0: Disabled...Not detected.

F633=1-100...The inverter will trip if the VIC input remains below the specified value for about 0.3 seconds.

[Parameter setting]

Title	Function	Adjustment range	Default setting
F633	Analog input break detection level (VIC)	0: Disabled 1-100%	0
F644	Operation selection of analog input break detection (VIC)	0: Tripping 1: Alarm only (Coast stop) 2: Alarm only (F649 frequency) 3: Alarm only (Maintain running) 4: Alarm only (Deceleration stop)	0
F649	Fallback frequency	L L -UL (Hz)	0.0

Note : The VIC input value may be judged earlier to be abnormal, depending on the degree of deviation of the analog data detected.

[Parameter setting]

Title	Function	Adjustment range	Default setting
F 6 3 4	Annual average ambient temperature (parts replacement alarms)	1: -10 to +10°C 2: 11-20°C 3: 21-30°C 4: 31-40°C 5: 41-50°C 6: 51-60°C	3

★ Display of part replacement alarm information

The time of replacement can be confirmed with the part replacement alarm information in the Status monitor mode. (Refer to chapter 8)

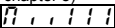
An example of display: 

★ Output of part replacement alarm signal

The parts replacement alarm is assigned to the output terminal.

Setup example) When the parts replacement alarm is assigned to the OUT terminal

Title	Function	Adjustment range	Setting
F 1 3 1	Output terminal selection 2A (OUT)	0-255	128: LTA (Parts replacement alarm)

Setting value 129 is reverse signal.

Note 1: Using F 6 3 4, enter the annual average temperature around the inverter. Be careful not to enter the annual highest temperature.

Note 2: Set F 6 3 4 at the time of installation of the inverter, and do not change its setting after the start of use. Changing the setting may cause parts replacement alarm calculation error.

★ The cumulative power on time, cumulative fan operation time and cumulative operation time until present time can be checked by setting status monitor mode. (Refer to chapter 8)

★ The monitor value of cumulative fan operation time and cumulative operation time are reset to 0(zero) by parameter t Y P (Refer to section 4.3.2) .

6



Function

This function is used to protect motor from overheating using the signal of PTC built-in motor.  
The trip display is "E - 32".

[Parameter setting]

Title	Function	Adjustment range	Default setting
F 147	Logic input / PTC input selection (S3)	0: Logic input 1: PTC input	0
F 545	PTC thermal selection	1: Tripping 2: Alarm only	1
F 546	PTC detection resistor value	100-9999 (Ω)	3000

Note : Protecting PTC thermal, set F 147= 1 (PTC input) and slide switch SW2 to PTC side.  
 ★ Tripping level is defined by F 545 setting. Alarm level is defined by 60% of F 545 setting.  
 ★ Connect the PTC between S3 and CC terminals.  
 Detection temperature can be set by F 545 setting.

[Connection]

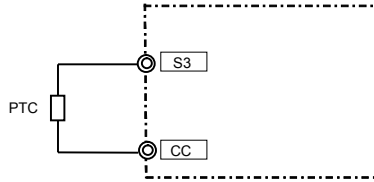

★ Output of PTC input alarm signal

The PTC input alarm is assigned to the output terminal.

Setup example) When the PTC input alarm is assigned to the OUT terminal

Title	Function	Adjustment range	Setting
F 131	Output terminal selection 2A (OUT)	0-255	150: PTCA (PTC input alarm signal)

Setting value 151 is reverse signal.

Title	Function	Adjustment range	Default setting
F 6 4 B	Number of starting alarm	0.0-999.0 (10000 times)	999.0

★ "0.1" displayed on the monitor refers to 1000 times, and therefore "1.0" denotes 10000 times.

Ex.: 38.5 displayed on the monitor = 385000 (times)

★ Display of number of starting alarm information

Number of starting alarm information in the Status monitor mode allows you to check on the time of replacement. (Refer to chapter 8)

An example of display: 

★ Output of number of starting alarm signal

The number of starting alarm is assigned to the output terminal.

Setup example) When the number of starting alarm is assigned to the OUT terminal

Title	Function	Adjustment range	Setting
F 1 3 1	Output terminal selection 2A (OUT)	0-255	162: NSA (Number of starting alarm)

Setting value 163 is reverse signal.

★ The number of starting, forward number of starting and reverse number of starting until present time can be monitored by setting status monitor mode. (Refer to chapter 8)

★ The monitor value of the number of starting, number of forward run and number of reverse run are reset to 0 (zero) by setting  $t 4 P = 1 2$  (number of starting clear). (Refer to section 4.3.2)

6

(1) Input terminal function 56 (FORCE) : Input signal is retained once signal is ON.  
 Motor runs at the speed set by the parameter "F 2 9 4".  
 Motor is forced to operate in case of light failure.

Note: This case needs to power off in order to stop

(2) Input terminal function 58 (FIRE) : Input signal is retained once signal is ON.  
 Motor runs at the speed set by the parameter "F 2 9 4".

Note: In either case, power terminal should be off in order to stop.

[Parameter setting]

Title	Function	Adjustment range	Default setting
F 6 5 0	Forced fire-speed control selection	0: Disabled 1: Enabled	0
F 2 9 4	Preset-speed frequency 15	L L - U L (Hz)	0.0

[Setup example of input terminal]

When the terminal "RES" is assigned.

Title	Function	Adjustment range	Setting value
F 1 1 3	Input terminal selection 3A (RES)	0 - 203	56 ( Forced run operation ) or 58 ( Fire speed operation )

Each setting value 57, 59 are reverse signal.

★ "F i r E" and output frequency are blinking during forced run operation and fire-speed operation.

**F220** : VIC input point 1 rate

**F221** : VIC input point 2 rate

**F660** : Override addition input selection

**F661** : Override multiplication input selection

**F729** : Operation panel override multiplication gain

6

• **Function**

These parameters are used to adjust reference frequencies by means of external input.

[Parameter setting]

Title	Function	Adjustment range	Default setting
<b>F205</b>	VIA input point 1 rate	0-250 (%)	0
<b>F206</b>	VIA input point 2 rate	0-250 (%)	100
<b>F214</b>	VIB input point 1 rate	-250-+250 (%)	0
<b>F215</b>	VIB input point 2 rate	-250-+250 (%)	100
<b>F220</b>	VIC input point 1 rate	0-250 (%)	0
<b>F221</b>	VIC input point 2 rate	0-250 (%)	100
<b>F660</b>	Override addition input selection	0: Disabled 1: Terminal VIA 2: Terminal VIB 3: Terminal VIC 4: <b>F729</b>	0
<b>F661</b>	Override multiplication input selection	0: Disabled 1: Terminal VIA 2: Terminal VIB 3: Terminal VIC 4: <b>F729</b>	0
<b>F729</b>	Operation panel override multiplication gain	-100-+100 (%)	0

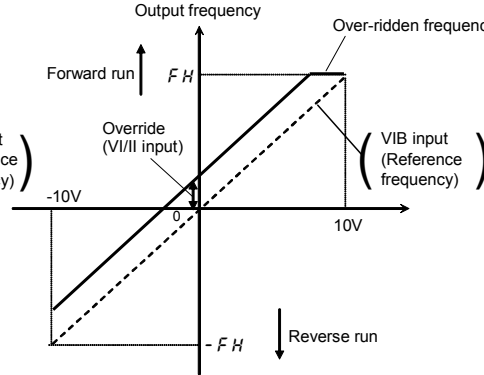
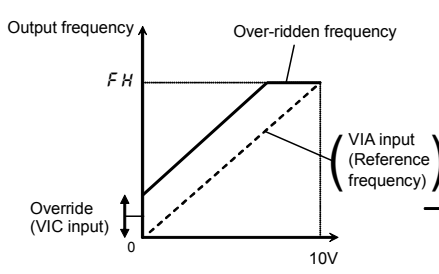
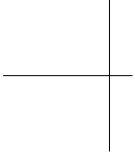

Ex.1:

$F_{\text{REF}} = 3$  (VIC input),  $F_{\text{OVR}} = 0$  (disabled)

**Output frequency = Reference frequency + Override (VIC input [Hz])**

Ex.2:

$F_{\text{REF}} = 1$  (VIA input),  $F_{\text{OVR}} = 0$  (disabled)

**Output frequency = Reference frequency + Override (VIA input [Hz])**

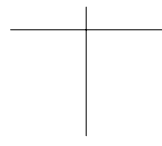
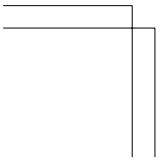

frequency

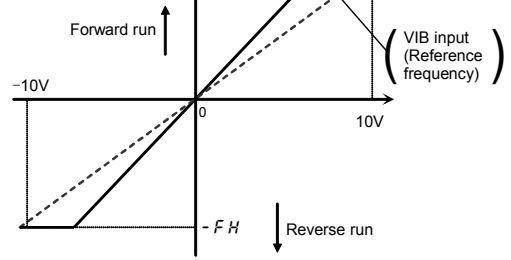
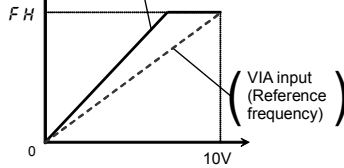

6

Ex.1:

*F 6 6 0=0* (Disabled), *F 6 6 1=3* (VIC input), *F 0 0 d=1* (VIA input), *F H=8 0.0*, *U L=8 0.0*

VIA input (*F 2 0 1=0*, *F 2 0 2=0.0*, *F 2 0 3=1 0 0*, *F 2 0 4=8 0.0*)

VIC input (*F 2 1 6=0*, *F 2 2 0=0*, *F 2 1 8=1 0 0*, *F 2 2 1=1 0 0*)

⇒ Setting of VIA input: Refer to Section 7.3.1, Setting of VIC input: Refer to Section 7.3.2.

**Output frequency = Reference frequency × {1 + Override (VIC input [%]/100)}**

Ex.2:

*F 6 6 0=0* (Disabled), *F 6 6 1=1* (VIA input), *F 0 0 d=2* (VIB input), *F H=8 0.0*, *U L=8 0.0*

VIB input (*F 2 1 0=0*, *F 2 1 1=0.0*, *F 2 1 2=1 0 0*, *F 2 1 3=8 0.0*)

VIA input (*F 2 0 1=0*, *F 2 0 5=0*, *F 2 0 3=1 0 0*, *F 2 0 6=1 0 0*)

⇒ Setting of VIB input: Refer to Section 7.3.3, Setting of VIA input: Refer to Section 7.3.1.

**Output frequency = Reference frequency × {1 + Override (VIA input [%]/100)}**

Ex.3:

Title	Function	Adjustment range	Default setting
<i>F 7 2 9</i>	Operation panel override multiplication gain	- 1 0 0-+ 1 0 0%	0

**Output frequency = Reference frequency × {1 + Override (*F 7 2 9* setting value [%]/100)}**

Function

Parameter is normally set from operation panel. However some parameters can be continuously set from external analog input by using this function. VIB terminal is used.

[Parameter setting]

Title	Function	Adjustment range	Default setting
<i>F214</i>	VIB input point 1 rate	-250~+250 (%)	0
<i>F215</i>	VIB input point 2 rate	-250~+250 (%)	100
<i>F663</i>	Analog input terminal function selection (VIB)	0: Frequency command 1: Acceleration/deceleration time 2: Upper limit frequency 3, 4: - 5: Torque boost value 6: Stall prevention level 7: Motor electronic-thermal protection level 8 to 10: - 11: Base frequency	0

★ Analog input terminal function assigns VIB terminal. The range of analog input voltage is 0% to +100%. From -100% to 0% cannot be used.

★ The parameter that is selected by *F663* can be adjusted range as following table.

Setting of <i>F663</i>	Object parameter	VIB : 0% input	VIB : 100% input
0: Frequency command	-	-	-
1: Acceleration/ deceleration time	<i>ACC, DEC, F500, F501, F510, F511</i>	Parameter setting value x <i>F214</i>	Parameter setting value x <i>F215</i>
2: Upper limit frequency	<i>UL</i>	Parameter setting value x <i>F214</i>	Parameter setting value x <i>F215</i>
5: Torque boost value	<i>ub, F172</i>	Parameter setting value x <i>F214</i>	Parameter setting value x <i>F215</i>
6: Stall prevention level	<i>F185, F601</i>	Parameter setting value x <i>F214</i>	Parameter setting value x <i>F215</i>
7: Motor electronic-thermal protection level	<i>THR, F173</i>	Parameter setting value x <i>F214</i>	Parameter setting value x <i>F215</i>
11: Base frequency	<i>ULU, F171</i>	Parameter setting value x <i>F214</i>	Parameter setting value x <i>F215</i>

Note: Adjustments are made by the inverter itself, so no changes are made to parameter settings

Function

Pulse signal can be output each time integral input power reaches integral power unit that is set by

*F 6 6 7*.

Pulse output width is set by *F 6 6 8*.

[Parameter setting]

Title	Function	Adjustment range	Default setting
<i>F 6 6 7</i>	Integral input power pulse output unit	0: 0.1kWh 1: 1kWh 2: 10kWh 3: 100kWh	1
<i>F 6 6 8</i>	Integral input power pulse output width	0.1-1.0 (s)	0.1

Setting example) When integral input power pulse is output from output terminal

Title	Function	Adjustment range	Setting
<i>F 1 3 1</i>	Output terminal selection 2A	0 - 255	180: IPU (Integral input power pulse output signal)

There is no reverse signal.

### 6.33.2 Pulse train output for meters

*F 6 6 9*: Logic output/pulse train output selection (OUT)

*F 6 7 6*: Pulse train output function selection (OUT)

*F 6 7 7*: Maximum numbers of pulse train output

*F 6 7 8*: Pulse train output filter

- Function  
Pulse trains can be sent out through the OUT output terminals.  
Set a pulse output mode and the number of pulses.

Ex.: When operations frequencies (0 to 60Hz) are put out by means of 0 to 600 pulses

*F H*=60.0, *F 6 6 9*=1, *F 6 7 6*=0, *F 6 7 7*=0.60



F 5 7 5	Pulse train output function selection (OUT)	3: Input voltage (DC detection)	150%	0			
		4: Output voltage (command value)	150%				
		5: Input power	185%				
		6: Output power	185%				
		7: Torque	250%				
		8: -	-				
		9: Motor cumulative load factor	100%				
		10: Inverter cumulative load factor	100%				
		11: PBR (Braking resistor) cumulative load factor	100%				
		12: Stator frequency	FH				
		13: VIA input value	10 V				
		14: VIB input value	10 V				
		15: Fixed output 1 (output current 100% equivalent)	185%				
		16: Fixed output 2 (output current 50% equivalent)	185%				
		17: Fixed output 3 (Other than the output current)	100%				
		18: Communication data	100.0%				
		19: -	-				
		20: VIC input value	-				
		21, 22: -	20mA				
		23: PID feedback value	-				
		F 5 7 7	Maximum numbers of pulse train output		0.50-2.00 (kpps)	-	0.80
		F 5 7 8	Pulse train output filter		2-1000 (ms)	-	64

★ Digital panel meter for reference  
 Type: K3MA-F (OMRON)  
 Connection terminal: OUT-E4, NO-E5

Note 1: When item of F 5 7 5 reaches "Reference of max. value", the number of pulse train set by F 5 7 7 are sent to output terminals (OUT)

Note 2: The ON pulse width is maintained constant.

The ON pulse width is fixed at a width that causes the duty to reach 50% at the maximum pulse number set with F 5 7 7.

Therefore, the duty is variable.

For example, the ON pulse width is approximately 0.6 ms when F 5 7 7 = 0.80 (pps)  
 approximately 0.5 ms when F 5 7 7 = 1.00 (pps)  
 approximately 0.3 ms when F 5 7 7 = 1.60 (pps)

Note 3: The minimum pulse output rate is 10pps. Keep in mind that no pulses can be put out at any rate smaller than this.

Note 4: F 5 7 5 =  $f_c$  is the motor drive frequency.

- Function

Output signal from the FM terminal can be switched between 0 to 1mAdc output, 0 to 20mAdc output, and 0 to 10Vdc output with the  $F5B1$  setting. The standard setting is 0 to 1mAdc output.

\* Optional frequency meter: When using QS60T, set  $F5B1=0$  (meter option (0 to 1mA) output).

[Parameter setting]

Title	Function	Adjustment range	Default setting
$F5B1$	Analog output signal selection	0: Meter option (0 to 1mA) 1: Current (0 to 20mA) output 2: Voltage (0 to 10V) output	0
$F5B4$	Analog output filter	2-1000 (ms)	2
$F5G1$	Inclination characteristic of analog output	0: Negative inclination (downward slope) 1: Positive inclination (upward slope)	1
$F5G2$	Analog output bias	-1.0 - +100.0 (%)	0.0

Note 1: In case of 0 to 20mAdc (4 to 20mAdc) output, or 0 to 10Vdc output, set  $F5B1$  to 1 or 2.

In case of 4 to 20mAdc output,  $F5G2$  needs adjustment.

6

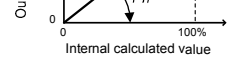

$F_{681}=1, F_{691}=0, F_{692}=100(\%)$

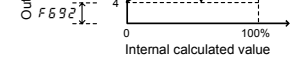
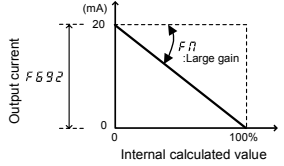

$F_{681}=1, F_{691}=0, F_{692}=100(\%)$

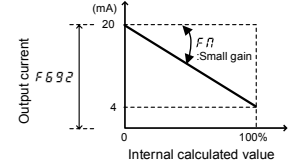

★ The analog output inclination can be adjusted using the parameter  $F_{68}$ .  
Refer to section 5.1 about how to adjustment.

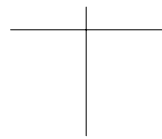
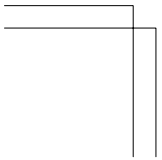
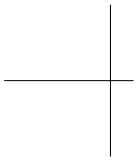

**F 731**: Disconnection detection of extension panel

**F 732**: Local/remote key prohibition of extension panel

**F 733**: Panel operation prohibition (RUN key)

**F 734**: Panel emergency stop operation prohibition

**F 735**: Panel reset operation prohibition

**F 736**: *CNOdIFNOd* change prohibition during operation

**F 737**: All key operation prohibition

**F 738**: Password setting (*F 700*)

**F 739**: Password verification

- Function

These parameters allow you to prohibit or allow operation of the RUN and STOP keys on the operation panel and the change of parameters. Using these parameters, you can also prohibit various key operations. Lock parameters with a password to prevent configuration.

[Parameter setting]

Title	Function	Adjustment range	Default setting
<i>F 700</i>	Parameter protection selection	0: Permitted 1: Writing prohibited (Panel and extension panel) 2: Writing prohibited (1 + RS485 communication) 3: Reading prohibited (Panel and extension panel) 4: Reading prohibited (3 + RS485 communication)	0
<i>F 730</i>	Panel frequency setting prohibition ( <i>FL</i> )	0: Permitted, 1: Prohibited	0
<i>F 731</i>	Disconnection detection of extension panel	0: Permitted, 1: Prohibited	0
<i>F 732</i>	Local/remote key prohibition of extension panel	0: Permitted, 1: Prohibited	1
<i>F 733</i>	Panel operation prohibition (RUN key)	0: Permitted, 1: Prohibited	0

<i>F 739</i>	Password verification	0: Password unset 1-9998 9999: Password set	0
--------------	-----------------------	---	---

★ Parameters can be edited regardless of the setting of *F 700* by assigning the parameter editing permission (function number 110, 111) to an input terminal.

Note1: *F 700=2* and *4* will be available after reset operation.

When protection using a password is necessary, set and remove with the following method.

### ■ Password setup method

Preparation: Parameters other than *F 700*, *F 738*, and *F 739* cannot be changed when *F 700* is set to *1* to *4*.

- (1) When *F 738* or *F 739* is read out and the value is *0*, a password hasn't been set.  
You can set a password.
- (2) When *F 738* or *F 739* is read out and the value is *9999*, a password has already been set.
- (3) You can set a password if it hasn't been set. Select and register a number from *1* to *9998* for *F 738*.  
The number is the password. Do not forget your password as it is required to release the lock.
- (4) The settings for parameter *F 700* cannot be changed.

Note2: The lock cannot be released if you forget the password. Do not forget this password as we cannot retrieve it.

Note3: Password cannot be set when parameter *F 700=0*.

Set the password after parameter *F 700=1* to *4*.

Note4: Password can be read out to parameter writer (optional device) only for 5 minutes after setting *F 738*. Please note that password will not be able to read out due to password protection after 5 minutes have elapsed or when the power is off.

### ■ Password examination method

- (1) When *F 738* or *F 739* are read out and the value is *9999*, a password has already been set.  
Password has to be removed in order to change parameters.
- (2) Enter a the number (*1* to *9998*) registered to *F 739* when the password was set for *F 738*.
- (3) If the password matches, *PR55* blinks on the display and the password is removed.
- (4) If the password is incorrect, *FR 1L* blinks on the display and *F 739* is displayed again.
- (5) When the password is removed, the setting for parameter *F 700* can be changed.
- (6) By setting parameter *F 700=0*, the all parameter settings can be changed.

Note5: Entry of *F 739* setting is possible up to 3 times. Please note it is impossible to set, if you enter the wrong number for 3 times. Number of times is reset after power is off.

<i>F 114</i>	Input terminal selection 4A (S1)	0-203	200: PWP (Parameter editing prohibition)
<i>F 115</i>	Input terminal selection 5 (S2)	0-203	202: PRWP (Parameter reading prohibition)

Setting value 201, 203 are reverse signal.

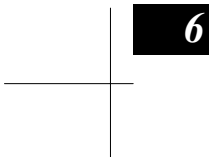

F-126

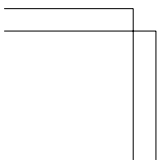

**F702**: Frequency free unit display magnification

**F703**: Frequency free unit coverage selection

**F705**: Inclination characteristic of free unit display

**F706**: Free unit display bias

⇒ Refer to section 5.10.2.

## 6.34.4 Change the steps in which the value increment

**F707**: Free step 1 (1-step rotation of setting dial)

**F708**: Free step 2 (panel display)

- Function

Changeable step width can be changed at panel frequency setting.

This function is useful when only running with frequencies of intervals of 1 Hz, 5 Hz, and 10 Hz units.

Note 1: The settings of these parameters don't work when the free unit selection (**F702**) is enabled.

Note 2: In case setting other than 0 to **F707** and increasing frequency by turning the setting dial to the right, frequency will not be increased beyond this point with the **H L** alarm when the frequency exceeds **UL** (Upper limit frequency) with just one more step rotation.

Similarly, when decreasing the frequency by turning the setting dial to the left and if the frequency falls below **LL** (lower limit frequency) with just one more step rotation, the **LL** alarm is displayed in advance and the frequency cannot be lowered beyond this point.

### ■ When **F707** is not 0.00, and **F708** = 0 (disabled)

Under normal conditions, the frequency command value from the operation panel increases by 0.1 Hz when you turn the setting dial to the right. If **F707** is not 0.00, the frequency command value will increase by the value with **F707** each time you turn the setting dial to the right by 1 step. Similarly, the frequency command value from the operation panel will decrease by the value set with **F707** when you turn the setting dial to the left by 1 step.

$F 707$	dial)	0.01- $F H$ (Hz)	0.00
$F 708$	Free step 2 (panel display)	0: Automatic 1-255	0

#### ■ Operation example 1

$F 707 = 0.00$  (disabled)

By rotating the setting dial 1 step, the panel frequency command value changes only 0.1 Hz.

When  $F 707 = 10.00$  (Hz) is set

Rotating the setting dial 1 step changes the panel frequency command value in 10.00 Hz increments, from 0.00 up to 60.00 (Hz).

#### ■ Operation example 2

When  $F 707 = 1.00$  (Hz), and  $F 708 = 1$ :

By rotating the setting dial 1 step, the frequency setting  $F \bar{L}$  changes in steps of 1Hz: 0 → 1 → 2 → ... → 60 (Hz) and also the value displayed on the operation panel changes in steps of 1. Use these settings to hide decimal fractions and also the value displayed on the operation panel changes in steps of 1. Use these settings to hide decimal fractions.

### 6.34.5 Select the initial display of the panel

$F 710$ : Initial panel display selection

$F 720$ : Initial extension panel display selection

- Function

This parameter specifies display format of the standard monitor mode when power is ON. Different contents can be displayed on the operation panel of main unit and the extension panel (option).

#### ■ Changing the display format while power is ON

When the power is ON, the standard monitor mode displays the output frequency (default setting) such as " $\bar{L}.0$ " or " $\bar{L} F F$ ". This format can be changed to any other monitor display format by setting  $F 710$ .

However, the initial letter including  $\bar{L}$  or  $\bar{L}$  will not be displayed. When the power is ON, set the display of the extension panel at  $F 720$ .

★ Different contents can be displayed on the operation panel of main unit and the extension panel (option).



F 7 10	Initial panel display selection	9: Motor cumulative load factor 10: Inverter cumulative load factor 11: PBR (Braking resistor) cumulative load factor 12: Stator frequency (Hz/free unit) 13: VIA input value (%) 14: VIB input value (%) 15 to 17: - 18: Arbitrary code from communication 19: - 20: VIC input value (%) 21: Pulse train input value (pps) 22: -	0
F 7 20	Initial extension panel display selection	23: PID feedback value (Hz/free unit) 24: Integral Input power (kWh) 25: Integral Output power (kWh) 26: Motor load factor (%) 27: Inverter load factor (%) 28: Inverter rated current (A) 29: FM output value (%) 30: Pulse train output value (pps) 31: Cumulative power on time (100 hours) 32: Cumulative fan operation time (100 hours) 33: Cumulative operation time (100 hours) 34: Number of starting (10000 times) 35: Forward number of starting (10000 times) 36: Reverse number of starting (10000 times) 37: Number of trip (times) 38, 39: - 40: Inverter rated current (Carrier frequency corrected) 41 to 51: - 52: Frequency command value / output frequency (Hz/free unit)	0

★ For details on F 7 10 / F 7 20 = 18, see "Communication Function Instruction Manual : E6581913".  
 Note: If F 7 20 = 18 setting, fixed value is displayed.

**F709**: Standard monitor hold function**F746**: Status monitor filter

- Function  
The standard monitor display can be hold.  
Some status monitors can be filtered to display.

6

☆ If **F709** is set to 0, the monitored values selected with **F710** (standard monitor display selection parameter) are displayed. For peak hold values and minimum hold values, the minimum values in each operation cycle are displayed. When the motor is at a standstill, the values monitored last are held as they were until the motor is started the next time.

The maximum and minimum values monitored after power is turned on is always displayed no matter whether the motor is in operation or at a standstill.

The maximum and minimum values are cleared to press the EASY key by setting **F750** to 3.

☆ "Output current", "Input voltage", "Output voltage" and "Torque" can be filtered by **F746**.

⇒ Refer to chapter 8 about status monitor.

[Parameter setting]

Title	Function	Adjustment range	Default setting
<b>F709</b>	Standard monitor hold function	0: Real time 1: Peak hold 2: Minimum hold	0
<b>F746</b>	Status monitor filter	8-1000 (ms)	200
<b>F750</b>	EASY key function selection	0: Easy / standard setting mode switching function 1: Shortcut key 2: Local / remote key 3: Monitor peak / minimum hold trigger 4: - 5: -	0

operation.

Parameter setting	At coast stop	Under voltage in main circuit alarm occurrence
$F719=0$	Operation command canceled	Operation command retained
$F719=1$	Operation command retained	
$F719=2$	Operation command canceled	

Operation command retained :

Inverter restarts due to canceling coast stop at coast stop.

Inverter restarts due to supply power source again when the under voltage in main circuit alarm (U.V.F) occurs.

Operation command canceled :

Inverter doesn't restart after coast stop or occurring the under voltage in main circuit alarm (U.V.F).

Press RUN key to operate again in panel operation.

Switch to ON the operation command in RS485 communication operation.

Title	Function	Adjustment range	Default setting
$F719$	Selection of operation command clear	0: Clear at coast stop and retained at U.V.F. 1: Retained at coast stop and U.V.F. 2: Clear at coast stop and U.V.F. 3: 2+ clear when C.U.V is changed	1

[Setup example of input terminal]

When it is assigned to the RES terminal.

Title	Function	Adjustment range	Setting
$F113$	Input terminal selection 3A (RES)	0-203	6: ST (Standby)
$F113$	Input terminal selection 3A (RES)	0-203	96: FRR (Coast stop command)

Setting value 7, 97 are reverse signal.

- 1) Deceleration stop  
The motor slows down to a stop in the deceleration time set with  $dEC$  (or  $F501$  or  $F511$ ).
- 2) Coast stop  
The inverter cuts off power supply to the motor. The motor comes to a stop after coasting for a while. Depending on the load, the motor may keep running for a longer time.

[Parameter setting]

Title	Function	Adjustment range	Default setting
$F721$	Panel stop pattern	0: Deceleration stop 1: Coast stop	0

6

## **F 794**: 7th and 8th characters of **F 790**

- Function

These parameters allow you to change the characters on panel display at power on.  
Default setting is "HELL0".

### [Parameter setting]

Title	Function	Adjustment range	Default setting
<i>F 790</i>	Panel display selection at power on	0: <i>HELL0</i> 1: <i>F 791</i> to <i>F 794</i> 2, 3: -	0
<i>F 791</i>	1st and 2nd characters of <i>F 790</i>	0-FFFF	2d2d
<i>F 792</i>	3rd and 4th characters of <i>F 790</i>	0-FFFF	2d2d
<i>F 793</i>	5th and 6th characters of <i>F 790</i>	0-FFFF	2d2d
<i>F 794</i>	7th and 8th characters of <i>F 790</i>	0-FFFF	2d2d

Select *F 790*= 1 and set displayed characters with *F 791* to *F 794* if it is displayed characters other than "HELL0".

Refer to "ASCII LED" of "Communication Function Instruction Manual : E6581912" about setting characters and set by hex number.

## 6.36 Integrating wattmeter

**F748** : Integrating wattmeter retention selection

**F749** : Integrating wattmeter display unit selection

6

• **Function**

At the main power off, display unit of integral output power values and whether or not retain integral output power values are selectable.

The integrating wattmeter display can be cleared by the signal to the input terminal.

Input terminal function 74, 75 (Integrating wattmeter display clear)

Title	Function	Adjustment range	Default setting
<i>F 748</i>	Integrating wattmeter retention selection	0: Disabled 1: Enabled	0
<i>F 749</i>	Integrating wattmeter display unit selection	0:1=1kWh 1:1=10kWh 2:1=100kWh 3:1=1000kWh 4:1=10000kWh	Depends on the capacity (Refer to section 11.4)

## 6.37 Parameter registration to easy setting mode

**F750** : EASY key function selection



**F751** to **F782** : Easy setting mode parameter 1 to 32

Up to 32 arbitrary parameters can be registered to easy setting mode.

⇒ Refer to section 4.5 for details.

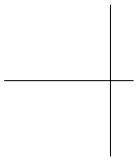
<b>F802</b>	Inverter number	<b>F823</b>	Selection of communication protocol
<b>F803</b>	Communication time-out time	<b>F856</b>	Number of motor poles for communication
<b>F804</b>	Communication time-out action	<b>F870</b>	Block write data 1
<b>F805</b>	Communication waiting time	<b>F871</b>	Block write data 2
<b>F806</b>	Setting of master and slave for communication between inverters	<b>F875</b>	Block read data 1
<b>F808</b>	Communication time-out detection condition	<b>F876</b>	Block read data 2
<b>F810</b>	Communication command point selection	<b>F877</b>	Block read data 3
<b>F811</b>	Communication command point 1 setting	<b>F878</b>	Block read data 4
<b>F812</b>	Communication command point 1 frequency	<b>F879</b>	Block read data 5
<b>F813</b>	Communication command point 2 setting	<b>F899</b>	Communication function reset



 <b>Warning</b>	
 Mandatory action	<ul style="list-style-type: none"> <li>Set the parameter Communication time-out time (<i>F803</i>), Communication time-out action (<i>F804</i>) and Disconnection detection of extension panel (<i>F731</i>). If these are not properly set, the inverter cannot be stopped immediately in breaking communication and this could result in injury and accidents.</li> <li>An emergency stop device and the interlock that fit with system specifications must be installed. If these are not properly installed, the inverter cannot be stopped immediately and this could result in injury and accidents.</li> </ul>

Refer to "Communication Function Instruction Manual : E6581913" for details.

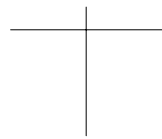
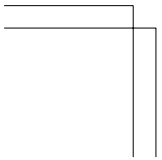

- This function allows you to set up a network that makes it possible to carry out proportional operation of multiple inverters (without using a computer).
- ★ Timer function ...Function used to detect cable interruptions during communication. When data is not sent even once to the inverter during a user-defined period of time, an inverter trip ( $E r r 5$  is displayed on the panel) or an output terminal alarm (" $E$ " is displayed) can be output.
  - ★ Broadcast communication function ...Function used to send a command (data write) to multiple inverters with a single communication.
  - ★ Peer-to-peer communication function ...Refers to the function that enables the master inverter to send the data selected with a parameter to all slave inverters on the same network. This function allows you to set up a network that makes it possible to carry out synchronized operation or proportional operation (setting of point frequencies) in an abbreviated manner.
  - ★ Communication protocol ...Toshiba inverter protocol and Modbus RTU protocol are supported

★ 2-wire RS485 communication options are as follows.

- (1) USB communication conversion unit (Type: USB001Z)  
Cable for communication between the inverter and the unit (Type: CAB0011 (1m), CAB0013 (3m), CAB0015 (5m))  
Cable for communication between the unit and computer: Use a commercially available USB 1.1 or 2.0 cables. (Type: A-B, Cable length: 0.25 to 1.5m)
- (2) Parameter writer (Type: RKP002Z)  
Communication cable (Type: CAB0011 (1m), CAB0013 (3m), CAB0015 (5m))
- (3) Parameter writer (Type: PWU003Z)  
RJ45 cable (1m) is attached.
- (4) Extension panel (Type: RKP007Z)  
Communication cable (Type: CAB0071 (1m), CAB0073 (3m), CAB0075 (5m))

Note1) In case of using above options, set the parameter  $F B 5 = 0.00$

■ Settings for run/stop via communication

Title	Function	Adjustment range	Standard defaults	Setting example
$C n d$	Command mode selection	0 - 4	1 (Panel keypad)	2 (RS485 communications)



[Parameter setting]			
Title	Function	Adjustment range	Default setting
<i>F800</i>	Baud rate	3: 9600bps 4: 19200bps 5: 38400bps	4
<i>F801</i>	Parity	0: No parity 1: Even parity 2: Odd parity	1
<i>F802</i>	Inverter number	0-247	0
<i>F803</i>	Communication time-out time *1	0: Disabled 0.1-100.0 (s)	0.0
<i>F804</i>	Communication time-out action *1	0: Alarm only 1: Trip (Coast stop) 2: Trip (Deceleration stop)	0
<i>F805</i>	Communication waiting time	0.00-2.00	0.00
<i>F806</i>	Setting of master and slave for communication between inverters	0: Slave (0 Hz command issued in case the master inverter fails) 1: Slave (Operation continued in case the master inverter fails) 2: Slave (Emergency stop tripping in case the master inverter fails) 3: Master (transmission of frequency commands) 4: Master (transmission of output frequency signals)	0
<i>F808</i>	Communication time-out detection condition	0: Valid at any time 1: Communication selection of <i>F80d</i> or <i>L80d</i> 2: 1 + during operation	1
<i>F810</i>	Communication command point selection	0: Disabled 1: Enabled	0
<i>F811</i>	Communication command point 1 setting	0-100	0
<i>F812</i>	Communication command point 1 frequency	0.0- <i>FH</i>	0
<i>F813</i>	Communication command point 2 setting	0-100	100
<i>F814</i>	Communication command point 2 frequency	0.0- <i>FH</i>	*2
<i>F829</i>	Selection of communication protocol	0: Toshiba inverter protocol 1: Modbus RTU protocol	0

6

<i>F870</i>	Block write data 1	2: Communication command 3: Frequency command value 4: Output data on the terminal block 5: FM analog output 6: Motor speed command	0
<i>F871</i>	Block write data 2		0
<i>F875</i>	Block read data 1	0: No selection 1: Status information 1 2: Output frequency 3: Output current 4: Output voltage 5: Alarm information 6: PID feedback value	0
<i>F876</i>	Block read data 2	7: Input terminal monitor 8: Output terminal monitor 9: Terminal VIA monitor 10: Terminal VIB monitor 11: Terminal VIC monitor	0
<i>F877</i>	Block read data 3	12: Input voltage (DC detection) 13: Motor speed 14: Torque	0
<i>F878</i>	Block read data 4		0
<i>F879</i>	Block read data 5		0
<i>F899</i>	Communication function reset	0: - 1: Reset (after execution: 0)	0

\*1: Disabled.....Indicates that the inverter will not be tripped even if a communication error occurs.

Trip..... The inverter trips when a communication time-over occurs.

In this case a trip information *E r r 5* flashes on and off on the operation panel.

Alarm ..... When a communication time-over occurs, an alarm can be output from the output terminal.

Output terminal function: 78 (RS485 communication error) or 79 (RS485 communication error reverse)

\*2: Default setting values vary depending on the setup menu setting. Refer to section 11.5.

Note2) Changes to the parameters *F800*, *F801* and *F805* do not take effect until the power is turned off and then on again.

frequency setting mode selection (*F F U d*) settings.

Moreover, selecting local mode with the EASY key as Local / remote key function changes to panel frequency/panel operation mode.

### ■ Transmission specifications

Item	Specifications	
Communication protocol	TOSHIBA inverter protocol	MODBUS-RTU protocol
Interface	RS485 compliant	
Transmission scheme	Half duplex [Serial bus type (Line terminations resistor necessary at both ends of system)]	
Wiring	2-wire	
Transmission distance	500 m max. (total length)	
Connection terminals	32max. (including upper host computer) Inverters connected in the system: 32max.	
Synchronization scheme	Start-stop synchronization	
Communication baud rate	9600 bps to 38.4kbps	
Character transmission	<ASCII mode> JIS X0201 8-bit(ASCII) <Binary mode> Binary codes fixed to 8 bits	Binary codes fixed to 8 bits
Error detecting scheme 1	Parity: Even/Odd/Non parity (selectable using a parameter)	
Error detecting scheme 2	Checksum	CRC
Stop bit length	Received by inverter : 1bit / Sent by inverter : 2 bits	
Order of bit transmission format	Low-order bits transmitted first	
Character transmission format	11-bit characters (Stop bit =1 , with parity)	
Inverter Number	<ASCII mode> 0-99 <Binary mode> 0-63 (3Fh)	1-247
Broadcast communication	Inverter Number should be set to <ASCII mode> ** (*? or ?* (?=0-9) is available) <Binary mode> 255 (0FFh)	Inverter Number should be set to 0
Frame length	Variable	
Error correction	None	
Response monitoring	None	
Other	Inverter operation at communication time-over: Select from trip/alarm/none → When alarm is selected, an alarm is output from the output terminal. When trip is selected, <i>E r 5</i> blinks on the panel.	

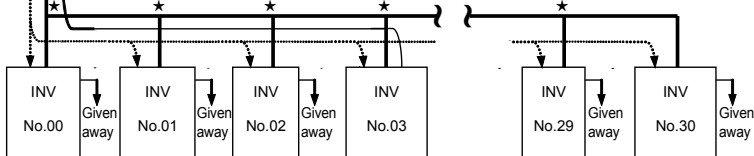

**6**

INV= inverter

"Given away": Only the inverter with the selected inverter number conducts data processing. All other inverters, even if they have received the data, give it away and stand by to receive the next data.

★ : Use the terminal block to branch the cable.

- (1) Data is sent from the host computer.
- (2) Data from the computer is received at each inverter and the inverter numbers are checked.
- (3) The command is decoded and processed only by the inverter with the selected inverter number.
- (4) The selected inverter responds by sending the processing results, together with its own inverter number, to the host computer.
- (5) As a result, only the selected inverter starts operating in accordance with the operation frequency command by communicating independently.

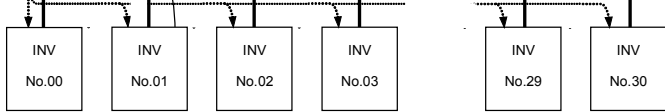

INV= inverter

★ : Split the cable among terminal blocks.

- (1) Send data from the host computer.
- (2) The inverters receive data from the host computer and the inverter number is checked.
- (3) When \* is next to the position of an inverter number, it is judged a broadcast. The command is decoded and processed.
- (4) To prevent data conflicts, only inverters where \* is overwritten to 0 can reply with data to the host computer.
- (5) As a result, all inverters are operating with the broadcast operation frequency command.

Note: Specify inverter numbers by group for group broadcasts.

(Function only for ASCII mode. For parity mode, see the Communications Function Instruction Manual.)

(Ex) When \*1 is set, inverters 01, 11, 21, 31 to 91 can be broadcast to.

In this case, the inverter specified in 01 can reply.

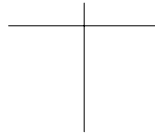
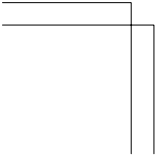
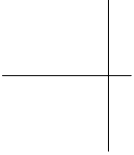

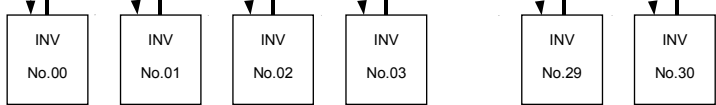

INV= inverter

★: Use the terminal block to branch the cable.

- (1) The master inverter transmits frequency command data to its slave inverters.
- (2) The slave inverter calculate a frequency reference from the data received and save the frequency calculated.
- (3) As a result, all slave inverters operate at the same frequency as the master inverter.

Note: The master inverter always sends frequency command data to its slave inverters.

The slave inverters are always on standby so that they can receive an frequency command from the master inverter at anytime.

### 6.38.3 Free notes

**F880**: Free notes

- Function  
To enable easier management and maintenance of the inverter, it is possible to enter the identification number.

[Parameter setting]

Title	Function	Adjustment range	Default setting
<b>F880</b>	Free notes	0 – 65530 (65535)	0

**[200]** to **[249]** : DeviceNet option parameters  
**[400]** to **[449]** , **[850]** to **[899]** : EtherCAT option parameters  
**[500]** to **[549]** : EtherNet common parameters  
**[550]** to **[599]** : EtherNet/IP option parameters  
**[600]** to **[649]** : Modbus TCP option parameters

★ CANopen option (Type: CAN001Z, CAN002Z, CAN003Z)  
CC- Link option (Type: CCL003Z)  
Profibus DP option (Type: PDP003Z)  
DeviceNet option (Type: DEV003Z)  
EtherNet / IP-Modbus TCP option (Type: IPE002Z)  
EtherCAT option (Type: IPE003Z)  
⇒ Refer to each Instruction Manual of option for details.

## 6.39 Permanent magnet motors

---

**[910]** : Step-out detection current level  
**[911]** : Step-out detection time  
**[912]** : q-axis inductance  
**[913]** : d-axis inductance  
**[915]** : Factory specific coefficient 9L

- Function

If the permanent magnet motor (PM motor) steps out and if the exciting current increases (it increases in such a case) and remains above the value set with **[910]** for the period of time set with **[911]**, the inverter will judge the motor to be stepping out and trip it. At that time, the trip message "SOUt" is displayed.

⇒ Refer to section 6.29.2 about setting motor constants.

Note 1: When using an PM motor, consult your Toshiba dealer, since the inverter is not compatible with all types of PM motors.

Note 2: The inverter may fail to detect step-out in some cases, because it uses an electrical method to detect step-out. To avoid detection failures, you are recommended to install a mechanical step-out detector.

## 6.40 Traverse function

---



6

**F980**: Traverse selection

**F981**: Traverse acceleration time

**F982**: Traverse deceleration time

**F983**: Traverse step

**F984**: Traverse jump step

⇒ Refer to "Traverse control Instruction Manual : E6581877" for details.



set the parameters.

[Procedure for setting parameters]

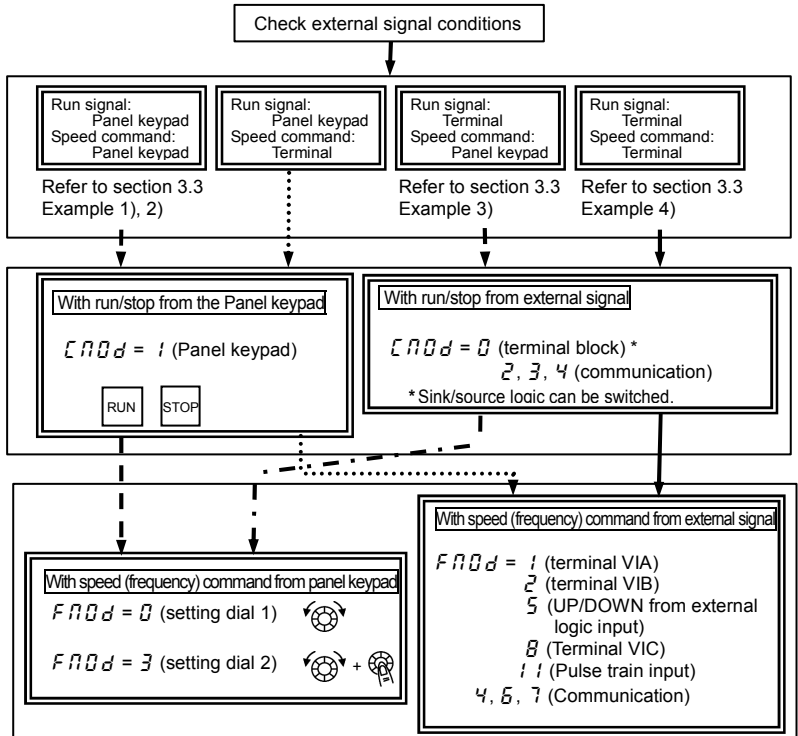

\* For settings based on communication, refer to the Communication Manual (E6581913) or section 6.33.

This function is used to send a signal to the input terminal from an external programmable controller to operate or configure the inverter.

The ability to select from a variety of functions allows for flexible system design.

Default settings of slide switch SW1 and SW2 are as follows;

SW1: PLC side, SW2: VIB side and S3 side.

Refer to page B-11 to 13 for details.

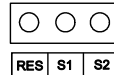
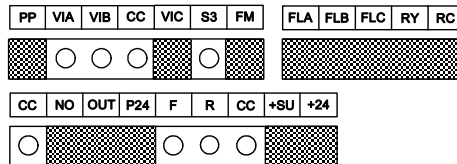
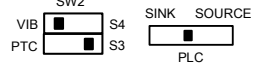

## ■ Settings for the logic input terminal function

Terminal symbol	Title	Function	Adjustment range	Default setting
F	F 111	Input terminal selection 1A (F)	0-203 Note 1)	2 (F)
	F 151	Input terminal selection 1B (F)		0 (No function)
	F 155	Input terminal selection 1C (F)		0 (No function)
R	F 112	Input terminal selection 2A (R)	0-203 Note 1)	4 (R)
	F 152	Input terminal selection 2B (R)		0 (No function)
	F 156	Input terminal selection 2C (R)		0 (No function)
RES	F 113	Input terminal selection 3A (RES)	0-203 Note 1)	8 (RES)
	F 153	Input terminal selection 3B (RES)		0 (No function)
S1	F 114	Input terminal selection 4A (S1)	0-203 Note 1)	10 (SS1)
	F 154	Input terminal selection 4B (S1)		0 (No function)
S2	F 115	Input terminal selection 5 (S2)	0-203 Note 3)	12 (SS2)
	F 146	Logic input / pulse train input selection (S2)	0: Logic input 1: Pulse train input	0
S3	F 116	Input terminal selection 6 (S3)	0-203 Note 4)	14 (SS3)
	F 147	Logic input / PTC input selection (S3)	0: Logic input 1: PTC input	0
VIB	F 117	Input terminal selection 7 (VIB)	8-55 Note 5)	16 (SS4)
VIA	F 118	Input terminal selection 8 (VIA)	8-55 Note 6)	24 (AD2)
VIA VIB	F 109	Analog/logic input selection (VIA/VIB)	0-4	0
F to VIB	F 144	Input terminal response time	1-1000 (ms) Note 7)	1

Note 7) When stable operation cannot be attained because of frequency setting circuit noise, increase the value of  $F 144$ .

### ■ Connecting

- 1) For logic input

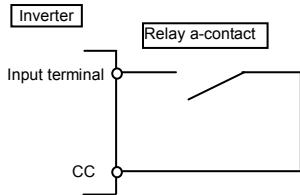

With sink settings

★ Operates by short circuiting between the input terminal and CC (common). Use for forward run, reverse run, preset-speed and so on.

- 2) For connection (sink logic) via transistor output

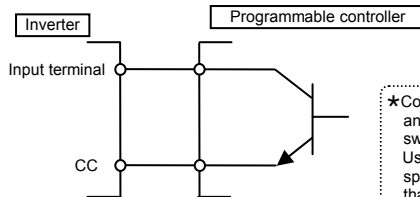

★ Control by connecting the input terminal and CC (common) to the output (non-logic switch) of the programmable controller. Use for forward run, reverse run, preset-speed and so on. Use a 5 mA transistor that operates at 24 V dc.

### ■ Usage example ... 3-wire operation (one-push operation)

Use the 3-wire operation function to operate the inverter, maintaining operation without using the sequence circuit by inputting an external signal (reset logic signal).

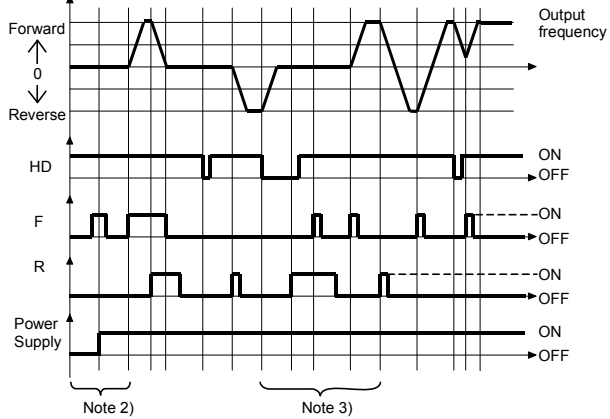
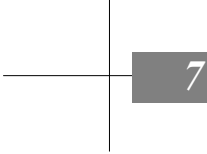

- Note 1) Set  $F110 = 5$  (ST: standby) and  $C100d = 0$  (terminal block) for 3 wire operation. Assign HD (operation hold) to any input terminal at input terminal selection. When assigning the S2 terminal as shown above, set  $F115 = 50$  (HD: Operation hold).
- Note 2) If the terminals are ON before turning on the power, terminal input is ignored when the power is turned ON. (Prevents sudden movements.) After turning the power ON, turn terminal input ON again.
- Note 3) When HD is OFF, F and R are ignored even when ON. R does not operate even if it's ON when HD is ON. Likewise in this state, F does not operate even if it's ON. Turn F and R OFF and then turn them ON.
- Note 4) During 3 wire operation, sending the jog run mode command stops operation.
- Note 5) Be aware that DC braking continues even if a startup signal is input during DC braking.
- Note 6) Only F and R maintain HD (operation hold). When using F or R in combination with other functions, be aware that the other functions do not hold. For example, when F and SS1 are assigned, F holds, but SS1 does not.

[Parameter settings]

Terminal symbol	Title	Function	Adjustment range	Setting example
S2	$F115$	Input terminal selection 5 (S2)	0-203	50: HD (Operation hold)

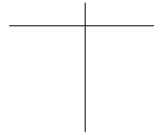
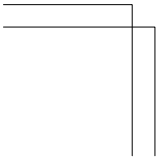

4	5	Reverse run command			prohibitive signal
6	7	Standby	80	81	Holding of RY-RC terminal output
8	9	Reset command	82	83	Holding of OUT-NO terminal output
10	11	Preset-speed command 1	88	89	Frequency UP *2
12	13	Preset-speed command 2	90	91	Frequency DOWN *2
14	15	Preset-speed command 3	92	93	Clear frequency UP/DOWN *2
16	17	Preset-speed command 4	96	97	Coast stop command
18	19	Jog run mode	98	99	Forward/reverse selection
20	21	Emergency stop by external signal	100	101	Run/Stop command
22	23	DC braking command	104	105	Frequency reference command forced switching
24	25	2nd acceleration/deceleration	106	107	Frequency setting mode terminal block
26	27	3rd acceleration/deceleration	108	109	Command mode terminal block
28	29	2nd V/F control mode switching	110	111	Parameter editing permission
32	33	2nd stall prevention level	120	121	Fast stop command 1
36	37	PID control prohibition	122	123	Fast stop command 2
46	47	External thermal error input	134	135	Traverse permission signal
48	49	Forced local from communication	136	137	Low voltage operation
50	51	Operation hold (hold of 3-wire operation)	140	141	Forward deceleration
52	53	PID integral/differential clear	142	143	Forward stop
54	55	PID characteristics switching	144	145	Reverse deceleration
56	57	Forced run operation	146	147	Reverse stop
58	59	Fire speed operation	148 to 151		Factory specific coefficient *1
60	61	Acceleration/deceleration suspend signal	152	153	No.2 motor switching
62	63	Power failure synchronized signal	200	201	Parameter editing prohibition
64	65	Factory specific coefficient *1	202	203	Parameter reading prohibition
70	71	Factory specific coefficient *1			

\*1: Factory specific coefficients are manufacturer setting menus. Do not change the value of these parameters.

\*2: Active when  $F R D$  (frequency setting mode selection) = 5 (UP/DOWN from external logic input) is set.

The frequency setup range is from  $0.0$  to  $F H$  (maximum frequency). The acceleration/deceleration time relative to the set frequency is  $R L / d E L$  while the acceleration/deceleration speed is not switched.

☆ Refer to section 11.6 for details about the input terminal function.

or both of them is ON.

Default settings of slide switch SW1 and SW2 are as follows;

SW1: PLC side, SW2: VIB side and S3 side.

Refer to page B-11 to 13 for details.

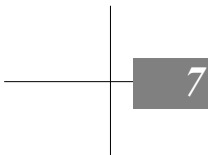
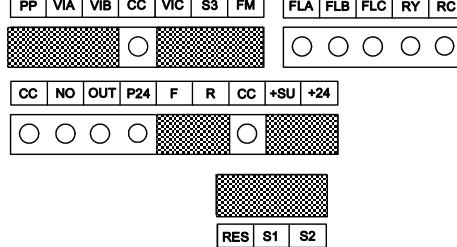

## ■ Usage

Function of FLA, B, C terminals:  
Set at parameter  $F 132$  (Note 1)

Function of RY terminal:  
Set at parameter  $F 130$  and  $137$  (Note 1)

Function of OUT terminal:  
Set at parameter  $F 134$  and  $138$

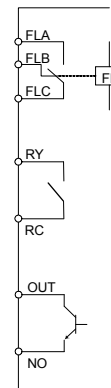

Note1) A chattering (momentary ON/OFF of contact) is generated by external factors of the vibration and the impact, etc. In particular, please set the filter of 10ms or more, or timer for measures when connecting it directly with input unit terminal of programmable controller. Please use the OUT terminal as much as possible when the programmable controller is connected.

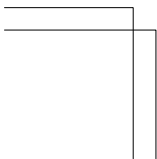

Leave parameter  $F 137$  as the default setting ( $F 137 = 255$ ).

Note 3) When assigning 1 type of function to the OUT terminal, set only  $F 131$ .

Leave parameter  $F 138$  as the default setting ( $F 138 = 255$ ).

■ Assign two types of functions to the output terminal (RY-RC, OUT)

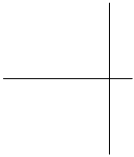

Terminal symbol	Title	Function	Adjustment range	Default setting
RY-RC	$F 130$	Output terminal selection 1A	0 - 255	4 (Low-speed detection signal)
	$F 137$	Output terminal selection 1B		255 (Always ON)
OUT	$F 131$	Output terminal selection 2A		6 (Output frequency attainment signal)
	$F 138$	Output terminal selection 2B		
RY-RC, OUT	$F 139$	Output terminal logic selection	0: $F 130$ and $F 137$ $F 131$ and $F 138$ 1: $F 130$ or $F 137$ $F 131$ and $F 138$ 2: $F 130$ and $F 137$ $F 131$ or $F 138$ 3: $F 130$ or $F 137$ $F 131$ or $F 138$	0

Note 4)  $F 131$  and  $F 138$  are active only when  $F 669 = 0$ : Logic output (default).  
 Function is inactive when  $F 669 = 1$ : Pulse train output is set.

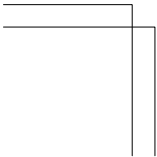

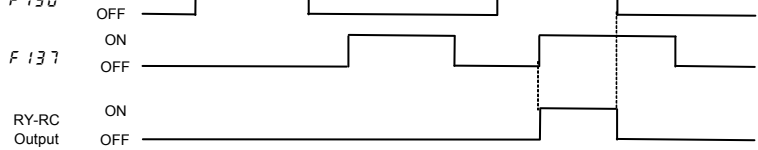

\* OUT terminal outputs signals when parameter  $F 139 = 0$  or  $2$ , and the functions set at parameters  $F 131$  and  $F 138$  are simultaneously turned on.

## (2) Output signals when either one of two types of functions is turned ON. <OR>

In case of RY-RC terminal, signals are output when parameter  $F 139 = 1$  or  $3$ , and either of the functions set at parameters  $F 130$  and  $F 137$  is turned on.

☆ Timing chart

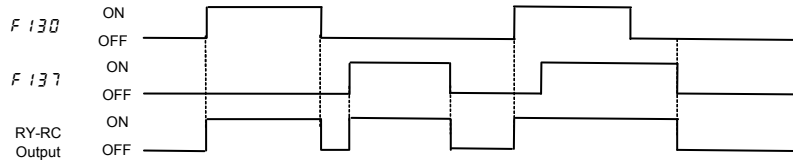

\*OUT terminal outputs signals when parameter  $F 139 = 2$  or  $3$ , and either of the functions set at parameters  $F 131$  and  $F 138$  is turned on.

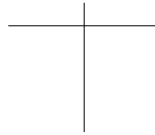
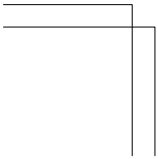
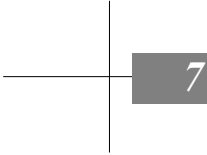



Function No.	Code	Function	Action
80	HDRY	Holding of RY-RC terminal output	ON : Once turned on, RY-RC are held on. OFF: The status of RY-RC changes in real time according to conditions.
82	HDOUT	Holding of OUT-NO terminal output	ON : Once turned on, OUT-NO are held on. OFF: The status of OUT-NO changes in real time according to conditions.

Each one of the following numbers (81, 83) is an inverse signal.

### ■ Usage example ...operational signal, brake signal

Low-speed detection signal outputs the signal when the output frequency exceeds the setting of  $F100$ .

This signal can be used as an operation signal by setting  $F100$  to 0.0Hz. (Default setting)

This signal can also be used as an electromagnetic brake excitation/release signal.

Setting example) When outputting the brake signal from RY-RC terminal

Title	Function	Adjustment range	Example of setting
$F100$	Low-speed signal output frequency	0.0 - $FH$ (Hz)	2.5
$F130$	Output terminal selection 1A (RY-RC)	0-255	4: LOW (Low-speed detection signal)

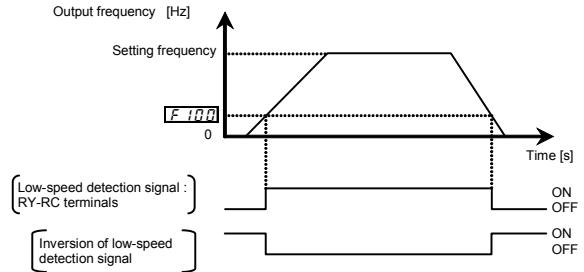

Positive logic	Negative logic		Positive logic	Negative logic	
0	1	Frequency lower limit	108	109	Heavy load output
2	3	Frequency upper limit	120	121	Lower limit frequency stop
4	5	Low-speed detection signal	122	123	Power failure synchronized operation
6	7	Output frequency attainment signal (acceleration/deceleration completed)	124	125	Traverse in progress
8	9	Set frequency attainment signal	126	127	Traverse deceleration in progress
10	11	Fault signal (trip output)	128	129	Parts replacement alarm
14	15	Over-current detection pre-alarm	130	131	Over-torque detection pre-alarm
16	17	Overload detection pre-alarm	132	133	Frequency setting mode selection 1/2
20	21	Overheat detection pre-alarm	136	137	Panel / remote selection
22	23	Overvoltage detection pre-alarm	138	139	Forced continuous operation in progress
24	25	Power circuit undervoltage detection	140	141	Specified frequency operation in progress
26	27	Small current detection	144	145	Signal in accordance of frequency command
28	29	Over-torque detection	146	147	Fault signal (output also at a retry waiting)
30	31	Braking resistor overload pre-alarm	150	151	PTC input alarm signal
40	41	Run/Stop	152	153	Factory specific coefficient *1
42	43	Serious failure	154	155	Analog input break detection alarm
44	45	Light failure	156	157	F terminal status
50	51	Cooling fan ON/OFF	158	159	R terminal status
52	53	In jogging operation	160	161	Cooling fan replacement alarm
54	55	Operation panel / terminal block operation	162	163	Number of starting alarm
56	57	Cumulative operation time alarm	166	167	Acceleration operation in progress
58	59	Communication option communication error	168	169	Deceleration operation in progress
60	61	Forward/reverse run	170	171	Constant speed operation in progress
62	63	Ready for operation 1	172	173	DC braking in progress
64	65	Ready for operation 2	174 to 179		Factory specific coefficient *1
68	69	Brake release	180	181	Integral input power pulse output signal
70	71	Pre-alarm	182	183	Shock monitoring pre-alarm signal
78	79	RS485 communication error	222 to 253		Factory specific coefficient *1
92	93	Designated data output 1	254		Always OFF
94	95	Designated data output 2	255		Always ON
106	107	Light load output			

\*1: Factory specific coefficients are manufacturer setting menus. Do not change the value of these parameters.

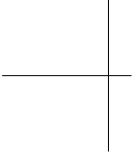

G-11

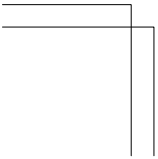

The selective function of analog input terminals gives system design flexibility. The maximum resolution is 1/1000. Default settings of slide switch SW1 and SW2 are as follows;  
SW1: PLC side, SW2: VIB side and S3 side. Refer to page B-11 to 13 for details.

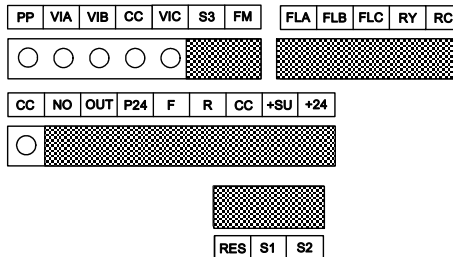

7

### ■ Analog input terminal function settings

Terminal symbol	Title	Function	Adjustment range	Default setting
VIA	<i>F 2 0 1</i>	VIA input point 1 setting	0 - 100%	0
	<i>F 2 0 2</i>	VIA input point 1 frequency	0.0 - 500.0Hz	0.0
	<i>F 2 0 3</i>	VIA input point 2 setting	0 - 100%	100
	<i>F 2 0 4</i>	VIA input point 2 frequency	0.0 - 500.0Hz	*1
VIB	<i>F 2 1 0</i>	VIB input point 1 setting	-100 - +100%	0
	<i>F 2 1 1</i>	VIB input point 1 frequency	0.0 - 500.0Hz	0.0
	<i>F 2 1 2</i>	VIB input point 2 setting	-100 - +100%	100
	<i>F 2 1 3</i>	VIB input point 2 frequency	0.0 - 500.0Hz	*1
VIC	<i>F 2 1 6</i>	VIC input point 1 setting	0 - 100%	20
	<i>F 2 1 7</i>	VIC input point 1 frequency	0.0 - 500.0Hz	0.0
	<i>F 2 1 8</i>	VIC input point 2 setting	0 - 100%	100
	<i>F 2 1 9</i>	VIC input point 2 frequency	0.0 - 500.0Hz	*1
VIA to VIC	<i>F 2 0 9</i>	Analog input filter	2 - 1000 ms Note 1)	64

\*1: Default setting values vary depending on the setup menu setting. Refer to section 11.5.

Note1) When stable operation cannot be attained because of frequency setting circuit noise, increase the value of *F 2 0 9*.

Note 2) Refer to section 5.8 when switching between two types of analog signals.

Title	Function	Adjustment range	Default setting	Setting example
<i>C 00 d</i>	Command mode selection	0 - 4	1 (panel keypad)	0 (terminal block)
<i>F 00 d</i>	Frequency setting mode selection 1	0 - 14	0 (setting dial 1)	1 (terminal VIA)
<i>F 10 9</i>	Analog/logic input selection (VIA/VIB)	0 - 4	0	0 or 1 (Analog input)
<i>F 20 1</i>	VIA input point 1 setting	0 - 100%	0	0
<i>F 20 2</i>	VIA input point 1 frequency	0.0 - 500.0Hz	0.0	0.0
<i>F 20 3</i>	VIA input point 2 setting	0 - 100%	100	100
<i>F 20 4</i>	VIA input point 2 frequency	0.0 - 500.0Hz	*1	50.0/60.0
<i>F 20 9</i>	Analog input filter	2 - 1000 ms	64	64

\*1: Default setting values vary depending on the setup menu setting. Refer to section 11.5.

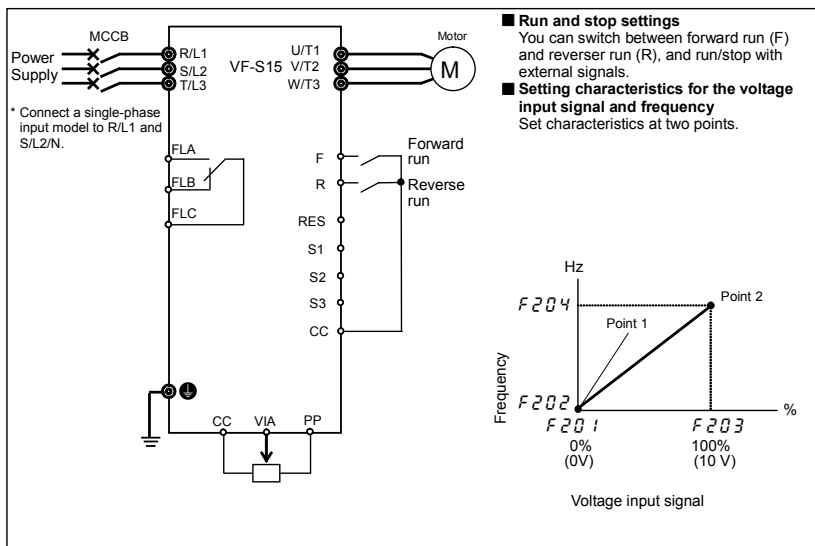

<i>F 2 0 0</i>	Command mode selection	0 - 4	(panel keypad)	(terminal block)
<i>F 2 0 1</i>	Frequency setting mode selection 1	0 - 14	0 (setting dial 1)	8 (terminal VIC)
<i>F 2 1 5</i>	VIC input point 1 setting	0 - 100%	20	20 (or 0)
<i>F 2 1 7</i>	VIC input point 1 frequency	0.0 - 500.0Hz	0.0	0.0
<i>F 2 1 8</i>	VIC input point 2 setting	0 - 100%	100	100
<i>F 2 1 9</i>	VIC input point 2 frequency	0.0 - 500.0Hz	*1	50.0/60.0
<i>F 2 0 9</i>	Analog input filter	2 - 1000 ms	64	64

\*1: Default setting values vary depending on the setup menu setting. Refer to section 11.5.

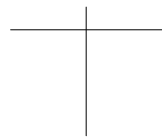
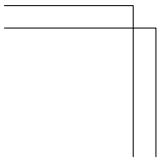
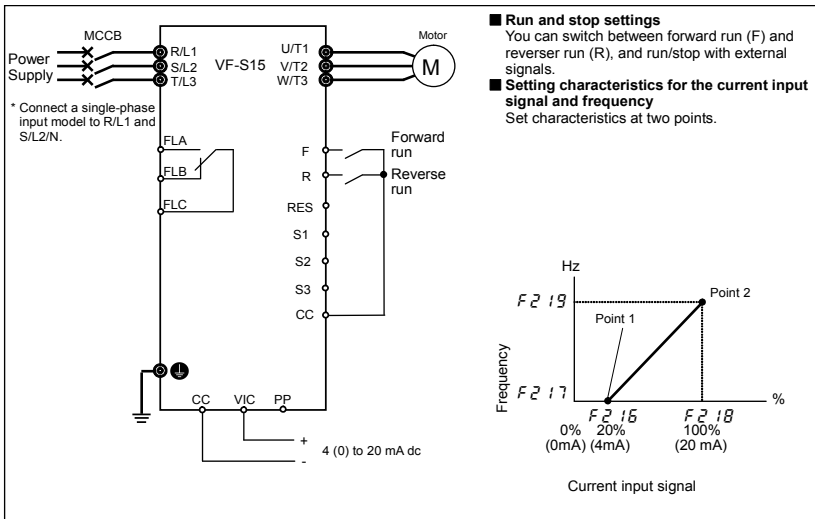
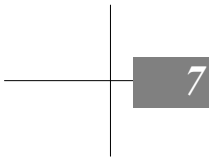





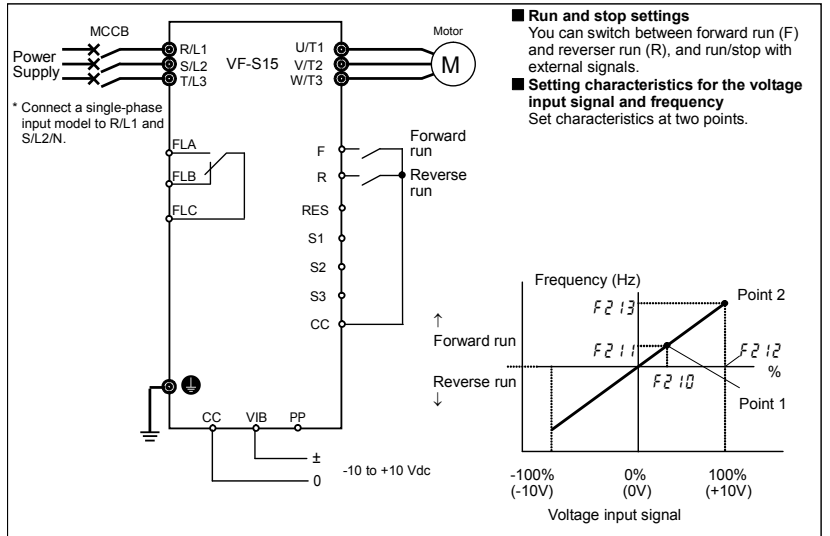

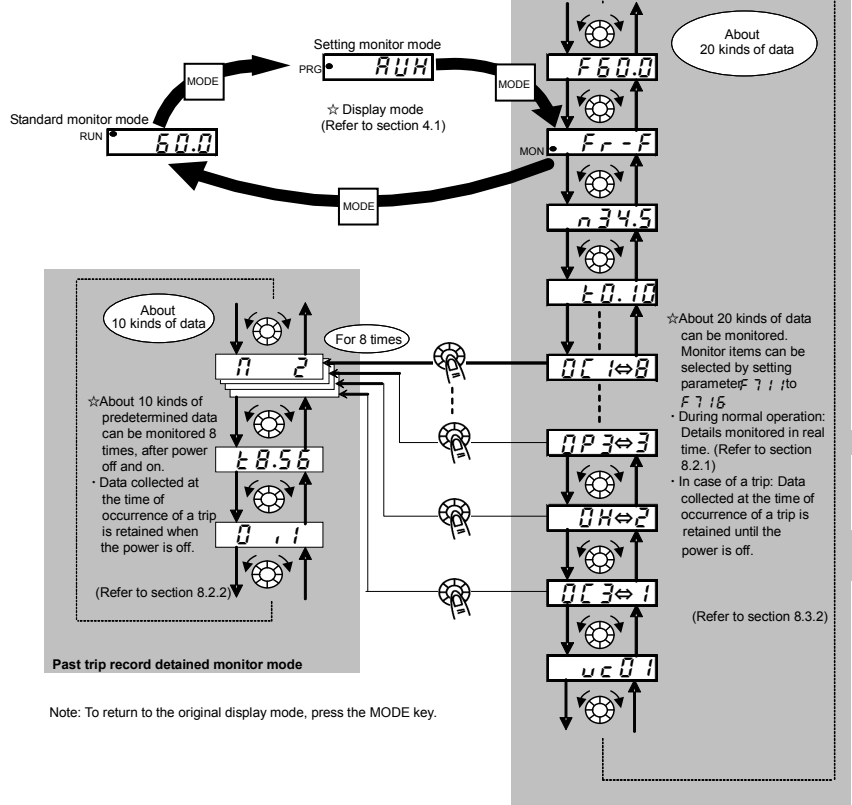



Selection	Setting	(Setting clear)	(Terminal VIB)
F 107	Analog input terminal selection (VIB)	0: 0-+10V 1: -10-+10V	1 (-10 - +10V)
F 209	Analog/logic input selection (VIA/VIB)	0 - 4	0 (Analog input)
F 210	VIB input point 1 setting	-100 - +100%	0 0
F 211	VIB input point 1 frequency	0.0 - 500.0Hz	0.0 0.0
F 212	VIB input point 2 setting	-100 - +100%	100 100
F 213	VIB input point 2 frequency	0.0 - 500.0Hz	*1 50.0/60.0
F 209	Analog input filter	2 - 1000 ms	64 64

\*1: Default setting values vary depending on the setup menu setting. Refer to section 11.5.







	Item displayed	Panel operated	LED display	Communication No.	Description
	Output frequency *		60.0		The output frequency is displayed (Operation at 60Hz). (When standard monitor display selection $F 7 10$ is set at 0 (output frequency))
	Parameter setting mode		RUH		The first basic parameter "RUH" (history function) is displayed.
	Direction of rotation		$F_r - F$	FE01	The direction of rotation is displayed. ( $F_r - F$ : forward run, $F_r - r$ : reverse run)
Note 1	Frequency command value *		$F 60.0$	FE02	The frequency command value (Hz/free unit) is displayed. (In case of $F 7 11=2$ )
Note 2	Output current *		$L 80$	FC02	The inverter output current (load current) (%A) is displayed. (In case of $F 7 12=1$ )
Note 2 Note 3	Input voltage *		$4 100$	FC05	The inverter Input voltage (DC detection) (%V) is displayed. (In case of $F 7 13=3$ )
Note 2	Output voltage *		$P 100$	FC08	The inverter output voltage (%V) is displayed. (In case of $F 7 14=4$ )
	Input power *		$h 12.3$	FC06	The inverter input power (kW) is displayed. (In case of $F 7 15=5$ )
	Output power *		$H 11.8$	FC07	The inverter output power (kW) is displayed. (In case of $F 7 16=6$ )
	Inverter load factor *		$L 70$	FE27	The inverter load factor (%) is displayed. (In case of $F 7 17=27$ )
	Output frequency *		$60.0$	FE00	The output frequency (Hz/free unit) is displayed. (In case of $F 7 18=0$ )

\* Monitor items can be selected by setting parameters  $F 7 10$  to  $F 7 18$ . ( $F 7 20$ ). Refer to Note 12.

Refer to page H-8 and 9 for notes.

(Continued overleaf)

					VIB S3 S2	R RES S1
Note 5	Output terminal		0 . . . 1	FE07	<p>The ON/OFF status of each of the control signal output terminals (RY-RC, OUT, FL) are displayed in bits.</p> <p>ON: 1 OFF: 0</p>	
	CPU1 version		v 1 0 1	FE08	The version of the CPU1 is displayed.	
	CPU2 version		v c 0 1	FE73	The version of the CPU2 is displayed.	
	Inverter rated current		R 3 3 . 0	FE70	The inverter rated current (A) is displayed.	
Note 6	Overload and region setting		C - E U	0998 0099	The inverter overload characteristic and region setting is displayed.	
Note 7	Past trip 1		0 P 2 ⇔ 1	FE10	Past trip 1 (displayed alternately)	
Note 7	Past trip 2		0 H ⇔ 2	FE11	Past trip 2 (displayed alternately)	
Note 7	Past trip 3		0 P 3 ⇔ 3	FE12	Past trip 3 (displayed alternately)	
Note 7	Past trip 4		0 L 1 ⇔ 4	FE13	Past trip 4 (displayed alternately)	
Note 7	Past trip 5		0 L r ⇔ 5	FD10	Past trip 5 (displayed alternately)	
Note 7	Past trip 6		0 C 1 ⇔ 6	FD11	Past trip 6 (displayed alternately)	
Note 7	Past trip 7		0 C 2 ⇔ 7	FD12	Past trip 7 (displayed alternately)	
Note 7	Past trip 8		n E r r ⇔ 8	FD13	Past trip 8 (displayed alternately)	

Refer to page H-8 and 9 for notes.

(Continued overleaf)

receiving or transmitting : /  
not receiving or not transmitting: ,

Note 8	Parts replacement alarm information		$n \dots \dots !$	FE79	<p>The ON/OFF status of each of the cooling fan, circuit board capacitor, main circuit capacitor of parts replacement alarm, cumulative operation time or number of starting are displayed in bits.</p>
	Cumulative operation time		$t 10.1$	FE14	The cumulative operation time is displayed. (0.10=10 hours, 1.00=100 hours)
Note 9	Number of starting		$n 34.5$	FD32	Number of starting (10000 times)
	Default display mode		$60.0$		The output frequency is displayed (Operation at 60Hz).

8

### 8.2.2 Display of detailed information on a past trip

Details on a past trip (of trips 1 to 8) can be displayed, as shown in the table below, by pressing the center of the setting dial when the trip record is selected in the status monitor mode.

Unlike the "Display of trip information at the occurrence of a trip" in 8.3.2, details on a past trip can be displayed, even after the inverter is turned off or reset.

	Item displayed	Panel operated	LED display	Description
Note 10	Past trip 1		$001 \leftrightarrow 1$	Past trip 1 (displayed alternately)
	Continuous trips		$n 2$	For $00A$ , $00L$ and $Err5$ the number of times (maximum of 31) the same trip occurred in succession is displayed (unit: times). Detailed information is recorded at the latest value.

Note 2	Output current		<i>C 150</i>	The inverter output current when the trip occurred is displayed. (%/A)
Note 2 Note 3	Input voltage		<i>Y 120</i>	The inverter input voltage (DC detection) when the trip occurred is displayed. (%/V).
Note 2	Output voltage		<i>P 100</i>	The inverter output voltage when the trip occurred is displayed. (%/V)
Note 4	Input terminal		<i>.....</i>	<p>The ON/OFF status of each of the control signal input terminals (F, R, RES, S1, S2, S3, VIB, VIA) are displayed in bits.</p> <p>ON: <i>!</i> OFF: <i>.</i></p>
Note 5	Output terminal		<i>0 . . .</i>	<p>The ON/OFF status of each of the control signal output terminals (RY-RC, OUT, FL) are displayed in bits.</p> <p>ON: <i>!</i> OFF: <i>.</i></p>
Note 9	Cumulative operation time		<i>t 8.56</i>	The cumulative operation time when the trip occurred is displayed. (0.10=10 hours, 1.00=100 hours)
	Past trip 1		<i>0C1 ⇔ !</i>	Press this key to return to past trip 1.











\*The monitor value of a trip is not always recorded as the maximum value because of the time required for detection.

Refer to page H-8 and 9 for notes.

### 8.3.2 Display of trip information at the occurrence of a trip

At the occurrence of a trip, the same information as that displayed in the mode described in "8.2.1 Status monitor under normal conditions", can be displayed, as shown in the table below, if the inverter is not turned off or reset. To display trip information after turning off or resetting the inverter, follow the steps described in "8.2.2 Display of detailed information on a past trip".

#### ■ Example of call-up of trip information

Item displayed	Panel operated	LED display	Communication No.	Description
Cause of trip		<i>OP2</i>		Status monitor mode (The code blinks if a trip occurs.) The motor coasts and comes to a stop (coast stop).
Parameter setting mode		<i>RUH</i>		The first basic parameter " <i>RUH</i> " (history function) is displayed.
Direction of rotation		<i>F r - F</i>	FE01	The direction of rotation at the occurrence of a trip is displayed. ( <i>F r - F</i> : forward run, <i>F r - r</i> : reverse run).
Note 1 Frequency command value *		<i>F 60.0</i>	FE02	The frequency command value (Hz/free unit) at the occurrence of a trip is displayed. (In case of <i>F 7 1 1=2</i> )
Note 2 Output current *		<i>130</i>	FC02	The output power of the inverter at the occurrence of a trip (%/A) is displayed. (In case of <i>F 7 1 2=1</i> )
Note 2 Note 3 Input voltage *		<i>4141</i>	FC05	The inverter input voltage (DC detection) (%/V) at the occurrence of a trip is displayed. (In case of <i>F 7 1 3=3</i> )
Note 2 Output voltage *		<i>P 100</i>	FC08	The output voltage of the inverter at the occurrence of a trip (%/V) is displayed. (In case of <i>F 7 1 4=4</i> )
Input power *		<i>h 12.3</i>	FC06	The inverter input power (kW) is displayed. (In case of <i>F 7 1 5=5</i> )
Output power *		<i>H 11.8</i>	FC07	The inverter output power (kW) is displayed. (In case of <i>F 7 1 6=6</i> )
Inverter load factor *		<i>L 70</i>	FE27	The inverter load factor (%) at the occurrence of a trip is displayed. (In case of <i>F 7 1 7=27</i> )
Output frequency *		<i>o 60.0</i>	FE00	The inverter output frequency (Hz/free unit) at the occurrence of a trip is displayed. (In case of <i>F 7 1 8=0</i> )

\* Monitor items can be selected by settings parameters *F 7 10* to *F 7 18* (*F 7 20*). Note 12

Refer to page H-8 and 9 for notes.





(Continued overleaf)

Note 5	Output terminal		0 . . . 1	FE07	<p>The ON/OFF status of each of the control signal output terminals (RY-RC, OUT, FL) are displayed in bits.</p> <p>ON: 1 OFF: 0</p>
	CPU1 version		u 1 0 1	FE08	The version of the CPU1 is displayed.
	CPU2 version		u c 0 1	FE73	The version of the CPU2 is displayed.
	Inverter rated current		R 3 3 . 0	FE70	The inverter rated current (A) is displayed.
Note 6	Overload and region setting		C - E U	0998 0099	The inverter overload characteristic and region setting is displayed.
Note 7	Past trip 1		0 P 2 ⇔ 1	FE10	Past trip 1 (displayed alternately)
Note 7	Past trip 2		0 H ⇔ 2	FE11	Past trip 2 (displayed alternately)
Note 7	Past trip 3		0 P 3 ⇔ 3	FE12	Past trip 3 (displayed alternately)
Note 7	Past trip 4		0 L 1 ⇔ 4	FE13	Past trip 4 (displayed alternately)
Note 7	Past trip 5		0 L r ⇔ 5	FD10	Past trip 5 (displayed alternately)
Note 7	Past trip 6		0 C 1 ⇔ 6	FD11	Past trip 6 (displayed alternately)
Note 7	Past trip 7		0 C 2 ⇔ 7	FD12	Past trip 7 (displayed alternately)
Note 7	Past trip 8		n E r r ⇔ 8	FD13	Past trip 8 (displayed alternately)

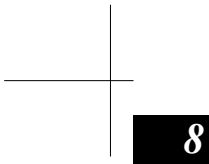
Refer to page H-8 and 9 for notes.

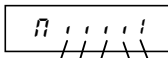
(Continued overleaf)



				receiving or transmitting : ! transmitting not receiving or not transmitting: ;	
Note 8	Parts replacement alarm information		<i>n . . . . . !</i>	FE79	The ON/OFF status of each of the cooling fan, circuit board capacitor, main circuit capacitor of parts replacement alarm, cumulative operation time or number of starting are displayed in bits.  ON: ! OFF: ; 
Note 9	Cumulative operation time		<i>t 10.1</i>	FE14	The cumulative operation time is displayed. (0.10=10 hours, 1.00=100 hours)
	Number of starting		<i>n 34.5</i>	FD32	Number of starting (10000 times)
	Default display mode		<i>OP2</i>		The cause of the trip is displayed.

Note 1: The characters to the left disappear at 100 Hz or more. (Ex: 120 Hz is *120.0*)

Note 2: You can switch between % and A (ampere)/V (volt), using the parameter *F 70 !* (current/voltage unit selection).

Note 3: The input (DC) voltage displayed is  $1/\sqrt{2}$  times as large as the rectified d.c. input voltage.

Note 4: < VIA bar > *F 109 = 3, 4* (Contact input): activated ON/OFF depend on VIA terminal input.  
*F 109 = 0 to 2* (Analog input): always OFF.

< VIB bar > *F 109 = 1 to 4* (Contact input): activated ON/OFF depend on VIB terminal input.  
*F 109 = 0* (Analog input): always OFF.

< S2 bar > *F 146 = 0* (Contact input): activated ON/OFF depend on S2 terminal input.  
*F 146 = 1* (Pulse train input): always OFF.

< S3 bar > *F 147 = 0* (Contact input): activated ON/OFF depend on S3 terminal input.  
*F 147 = 1* (PTC input): always OFF.

Note 5: < OUT bar > *F 669 = 0* (Logic output): activated ON/OFF depend on OUT terminal output.  
*F 669 = 1* (Pulse train output): always OFF.

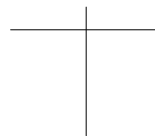
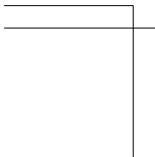

Note 7: Past trip records are displayed in the following sequence: 1 (latest trip record) 02004000007000 (oldest trip record). If no trip occurred in the past, the message "n E r r" will be displayed. Details on past trip record 1 to 8 can be displayed by pressing the center of the setting dial when past trip 1 to 8 is displayed. Refer to section 8.2.2 for details.

Note 8: Parts replacement alarm is displayed based on the value calculated from the annual average ambient temperature specified using  $F 5 3 4$ , the ON time of the inverter, the operating time of the motor and the output current (load factor). Use this alarm as a guide only, since it is based on a rough estimation.

Note 9: The cumulative operation time increments only when the machine is in operation.

Note 10: If there is no trip record, n E r r is displayed.

Note 11: Of the items displayed on the monitor, the reference values of items expressed in percent are listed below.

- Output current: The current monitored is displayed in percentage. The value indicated on the nameplate is 100%. The unit can be switched to A (amperes).
- Input voltage: The voltage displayed is the voltage determined by converting the voltage measured in the DC section into an AC voltage. The reference value (100% value) is 200V (240V class), 400V (500V class). The unit can be switched to V (volts).
- Output voltage: The voltage displayed is the output command voltage. The reference value (100% value) is 200V (240V class), 400V (500V class). This unit can be switched to V (volts).
- Load factor of inverter: Depending on the PWM carrier frequency ( $F 3 0 0$ ) setting and so on, the actual rated current may become smaller than the rated output current indicated on the nameplate. With the actual rated current at that time (after a reduction) as 100%, the proportion of the load current to the rated current is indicated in percent. The load factor is also used to calculate the conditions for overload trip ( $0 L 1$ ).

Note 12: Status monitor of \* mark is displayed by  $F 7 1 0$  to  $F 7 1 8$  and  $F 7 2 0$  setting. The left side character is as following table by each parameter setting number.

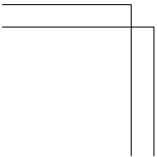
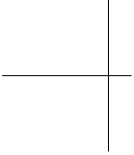



6	H 2.8	Output power *1	kW	FC07
7	q 8.0	Torque *1, *2	%	FC04
9	G 6.0	Motor cumulative load factor	%	FE23
10	L 8.0	Inverter cumulative load factor	%	FE24
11	r 8.0	PBR (Braking resistor) cumulative load factor	%	FE25
12	b 5 1.0	Stator frequency	Hz / free unit	FE15
13	A 6.5	VIA input value	%	FE35
14	b 4.5	VIB input value *2	%	FE36
18	*3	Arbitrary code from communication	*3	*3
20	C 3.5	VIC input value	%	FE37
21	P 8.0.0	Pulse train input value	pps	FE56
23	d 4.0.0	PID feedback value	Hz / free unit	FE22
24	h 3.5.6	Integral input power	Depend on F 7.4.9	FE76
25	H 3.4.0	Integral output power	Depend on F 7.4.9	FE77
26	G 7.5	Motor load factor	%	FE26
27	L 7.0	Inverter load factor	%	FE27
28	R 3.3.0	Inverter rated current	A	FE70
29	F 7.0	FM output value	%	FE40
30	P 8.0.0	Pulse train output value	pps	FD40
31	P 3.4.5	Cumulative power on time	100 hours	FE80
32	F 2.8.6	Cumulative fan operation time	100 hours	FD41
33	t 2 7.7	Cumulative operation time	100 hours	FD14
34	n 8.9.0	Number of starting times	10000 times	FD32
35	F 4.5.5	Forward number of starting times	10000 times	FD33
36	r 4.3.5	Reverse number of starting times	10000 times	FD34
37	R 2	Number of trip	times	FD35
40	R 3.3.0	Inverter rated current (Carrier frequency corrected)	A	FD70
52	c 5.0.0	During stop : Frequency command value During operation : Output frequency	Hz / free unit	FE99

F 7 1.0  
to F 7 1.8,  
F 7 2.0

8

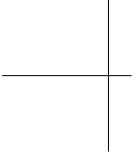

H-11

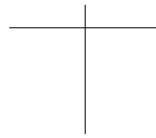
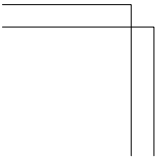

with other machines or systems for the purpose of controlling them. So they themselves were not considered to be subject to the EMC Directive. However the component also became subject to law with the enforcement of the new EMC Directive in 2007. For this reason, we put CE mark on all inverters in accordance with the EMC Directive and the Low Voltage Directive.

The CE mark must be put on all machines and systems with built-in inverters because such machines and systems are subject to the above directives. If they are "final" products, they might also be subject to the Machinery Directive. It is the responsibility of the manufacturers of such final products to put the CE mark on each final product. In order to make machines and systems with built-in inverters comply with the EMC Directive and the Low Voltage Directive, this section explains how to install inverters and what measures should be taken to satisfy the EMC Directive.

We have tested representative models with them installed under the environment described later in this manual to check for conformity with the EMC Directive. However, we cannot check the inverters under your operating environment. EMC varies depending on the composition of the control panel with a built-in inverter(s), the relationship with other built-in electrical components, the wiring condition, the layout condition, and so on. Therefore, please verify yourself whether your machine or system conforms to the EMC Directive.

### 9.1.1 About the EMC Directive

The CE mark must be put on every final product that includes an inverter(s) and a motor(s). In this series of inverters are equipped with an EMC filter and complies with the EMC Directive if wiring is carried out correctly.

- EMC Directive  
2004/108/EC

The EMC standards are broadly divided into two categories; Emission and Immunity, each of which is further categorized according to the operating environment of each individual machine. Since inverters are intended for use with industrial systems under industrial environments, they fall within the EMC categories listed in Table 1 below. We consider that the tests required for machines and systems as final products are almost the same as those required for inverters.

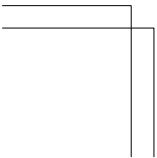
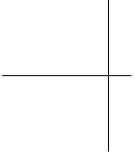

## 9.1.2 Measures to satisfy the EMC Directive

This subsection explains what measures must be taken to satisfy the EMC Directive.

(1) Insert an EMC filter on the input side of the inverter to reduce transmission noise and radiation noise from input cables.

Single-phase 240V class and three-phase 500V class inverters are equipped with an EMC filter.

Table 2 Combinations of inverter and EMC filter

Three-phase 240 V class

Inverter type	Combination of inverter and filter	
	Conductive noise IEC61800-3, category C2 (PWM carrier frequency of 4kHz and motor wiring length of 5m or less)	Conductive noise IEC61800-3, category C1 (PWM carrier frequency of 4kHz and motor wiring length of 1m or less)
VFS15-2004PM-W		
VFS15-2007PM-W		
VFS15-2015PM-W		
VFS15-2022PM-W		
VFS15-2037PM-W		
VFS15-2055PM-W		
VFS15-2075PM-W		
VFS15-2110PM-W		
VFS15-2150PM-W		

Contact your Toshiba distributor.

9

VFS15S-2015PL-W	
VFS15S-2022PL-W	

Three-phase 500 V class

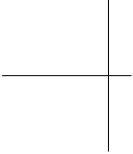

Inverter type	Conductive noise IEC61800-3, category C2 (PWM carrier frequency of 12kHz and motor wiring length of 5m or less)	Conductive noise IEC61800-3, category C3 (PWM carrier frequency of 12kHz and motor wiring length of 25m or less)
VFS15-4004PL-W	Built-in filter	-
VFS15-4007PL-W		
VFS15-4015PL-W		
VFS15-4022PL-W		
VFS15-4037PL-W		
VFS15-4055PL-W	-	Built-in filter
VFS15-4075PL-W		
VFS15-4110PL-W		
VFS15-4150PL-W		

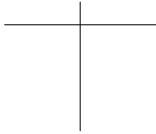
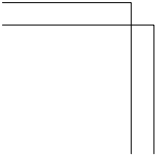

- (5) It is effective to earth shielded cables in the vicinity of the inverter and cabinet (within a radius of 10cm from each of them). Inserting a ferrite core in a shielded cable is even more effective in limiting the radiation noise.
- (6) To further limit the radiation noise, insert a zero-phase reactor in the inverter output line and insert ferrite cores in the earth cables of the metal plate and cabinet.

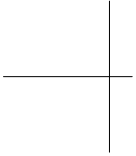

9



I-4

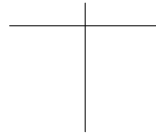
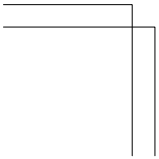

modifying it as shown below.

Remove the covering of the cable and fix the shield in the metal saddle.

Fixed by insulation lock

EMC plate

Braking resistor wiring (Shielded cables)  
PA+, PB

Control wiring (Shielded cables)

Power supply wiring (Shielded cables)  
R/L1, S/L2, S/L2/N, T/L3



Motor wiring (Shielded cables)  
U/T1, V/T2, W/T3

Control wiring (Shielded cables)

## 9.1.4 Measures to satisfy the Low Voltage Directive

When incorporating the inverter into a machine or system, it is necessary to take the following measures so that the inverter satisfies the Low Voltage Directive.

- (1) Install the inverter in a cabinet and ground the inverter enclosure. When doing maintenance, be extremely careful not to put your fingers into the inverter through a wiring hole and touch a charged part, which may occur depending on the model and capacity of the inverter used.
- (2) Connect earth wiring to the earth terminal on the EMC plate. Or install the EMC plate (attached as standard) and another cable connect to earth terminal on the EMC plate. Refer to the table in 10.1 for details about earth cable sizes. A minimum wire size of  $10\text{mm}^2$  may be required to meet standards limiting leakage current.
- (3) Install a non-fuse circuit breaker or a fuse on the input side of the inverter. (Refer to section 10.1 and 9.2.3)

## 9.2 Compliance with UL Standard and CSA Standard

This inverter that conform to the UL Standard and CSA Standard based on the rated current of the nameplate have the UL/CSA mark on the nameplate.

### 9.2.1 Compliance with Installation

A UL certificate was granted on the assumption that the inverter would be installed in a cabinet. Therefore, install the inverter in a cabinet and if necessary, take measures to maintain the ambient temperature (temperature in the cabinet) within the specified temperature range. (Refer to section 1.4.4)

### 9.2.2 Compliance with Connection

Use the UL conformed cables (Rating  $75\text{ }^{\circ}\text{C}$  or more, Use the copper conductors only.) to the main circuit terminals (R/L1, S/L2, S/L2/N, T/L3, U/T1, V/T2, W/T3).

For instruction in the United States, Integral solid state short circuit protection does not provide branch circuit protection. Branch circuit protection must be provided in accordance with the National Electrical Code and any additional local codes.



■ AIC, Fuse and Wire sizes

Inverter model	Voltage (V)	Input withstand rating (kA)	Output Interrupt rating (kA)	Branch circuit protection	Rating (A)	Cable sizes of power circuit	Earth Cable
Markig	Y	(1)	X (2)	Z1	Z2	-	-
VFS15-2004PM-W	240	5	5	Class CC	7	AWG 14	AWG 14
VFS15-2007PM-W	240	5	5	Class J	15	AWG 14	AWG 14
VFS15-2015PM-W	240	5	5	Class J	25	AWG 14	AWG 14
VFS15-2022PM-W	240	5	5	Class J	25	AWG 12	AWG 14
VFS15-2037PM-W	240	5	5	Class J	45	AWG 10	AWG 10
VFS15-2055PM-W	240	22	5	Class J	60	AWG 8	AWG 10
VFS15-2075PM-W	240	22	5	Class J	70	AWG 6	AWG 10
VFS15-2110PM-W	240	22	5	Class J	100	AWG 6*2	AWG 8
VFS15-2150PM-W	240	22	5	Class J	110	AWG 6*2	AWG 8
VFS15S-2002PL-W	240	1	5	Class CC	7	AWG 14	AWG 14
VFS15S-2004PL-W	240	1	5	Class J	15	AWG 14	AWG 14
VFS15S-2007PL-W	240	1	5	Class J	25	AWG 14	AWG 14
VFS15S-2015PL-W	240	1	5	Class J	40	AWG 10	AWG 12
VFS15S-2022PL-W	240	1	5	Class J	45	AWG 10	AWG 10
VFS15-4004PL-W	500	5	5	Class CC	6	AWG 14	AWG 14
VFS15-4007PL-W	500	5	5	Class CC	6	AWG 14	AWG 14
VFS15-4015PL-W	500	5	5	Class CC	12	AWG 14	AWG 14
VFS15-4022PL-W	500	5	5	Class J	15	AWG 14	AWG 14
VFS15-4037PL-W	500	5	5	Class J	25	AWG 12	AWG 14
VFS15-4055PL-W	500	22	5	Class J	40	AWG 10	AWG 10
VFS15-4075PL-W	500	22	5	Class J	40	AWG 8	AWG 10
VFS15-4110PL-W	500	22	5	Class J	60	AWG 8	AWG 10
VFS15-4150PL-W	500	22	5	Class J	70	AWG 6	AWG 10

Suitable for use on a circuit capable of delivering not more than   X   rms symmetrical kilo Amperes,   Y   Volts maximum, when protected by   Z1   with a maximum rating of   Z2  .

Selects the electronic thermal protection characteristics that fit with the ratings and characteristics of the motor.  
(Refer to section 3.5)  
In case of multi motor operation with one inverter, thermal relay should be connected to each motor.

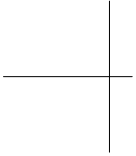

9



I-8

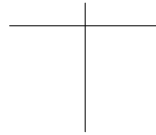
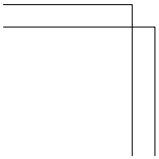



Be Grounded

• Ground must be connected securely.  
If the ground is not securely connected, it could lead to electric shock or fire.

## 10.1 Selection of wiring materials and devices

### ■ Selection of wire size

Voltage class	Applicable motor (kW)	Wire size (mm <sup>2</sup> ) Note 4)							
		Power circuit Note 1) Note 5)						DC Reactor (Optional)	
		Input			Output				
		without DCL		with DCL		IEC Compliant	For Japan *1	IEC Compliant	For Japan *1
IEC Compliant	For Japan *1	IEC Compliant	For Japan *1						
3 phase 240V class	0.4	1.5	2.0	1.5	2.0	1.5	2.0	1.5	2.0
	0.75	1.5	2.0	1.5	2.0	1.5	2.0	1.5	2.0
	1.5	1.5	2.0	1.5	2.0	1.5	2.0	1.5	2.0
	2.2	2.5	2.0	1.5	2.0	1.5	2.0	1.5	2.0
	4.0	4.0	2.0	2.5	2.0	2.5	2.0	4.0	2.0
	5.5	10	5.5	4.0	2.0	6.0	3.5	6.0	3.5
	7.5	16	8.0	6.0	3.5	10	3.5	10	5.5
	11	25	14	10	5.5	16	8.0	16	8.0
	15	35	22	16	14	25	14	25	14
	18.5	50	22	25	14	35	14	35	22
1 phase 240V class	0.2	1.5	2.0	1.5	2.0	1.5	2.0	1.5	2.0
	0.4	1.5	2.0	1.5	2.0	1.5	2.0	1.5	2.0
	0.75	1.5	2.0	1.5	2.0	1.5	2.0	1.5	2.0
	1.5	2.5	2.0	2.5	2.0	1.5	2.0	2.5	2.0
	2.2	4.0	2.0	4.0	2.0	1.5	2.0	4.0	2.0
	3.0	4.0	2.0	4.0	2.0	1.5	2.0	4.0	2.0
3 phase 500V class	0.4	1.5	2.0	1.5	2.0	1.5	2.0	1.5	2.0
	0.75	1.5	2.0	1.5	2.0	1.5	2.0	1.5	2.0
	1.5	1.5	2.0	1.5	2.0	1.5	2.0	1.5	2.0
	2.2	1.5	2.0	1.5	2.0	1.5	2.0	1.5	2.0
	4.0	2.5	2.0	1.5	2.0	1.5	2.0	1.5	2.0
	5.5	4.0	2.0	1.5	2.0	2.5	2.0	2.5	2.0
	7.5	6.0	3.5	2.5	2.0	2.5	2.0	4.0	2.0
	11	10	5.5	4.0	2.0	6.0	3.5	6.0	3.5
	15	16	8.0	6.0	3.5	10	3.5	10	5.5
	18.5	16	8.0	10	5.5	10	5.5	16	8.0

240V class	4.0	2.5	2.0	4.0	3.5
	5.5	4.0	2.0	10	5.5
	7.5	6.0	3.5	16	5.5
	11	16	5.5	16	8.0
	15	25	14	16	8.0
	18.5	25	14	25	8.0
1 phase 240V class	0.2	1.5	2.0	2.5	2.0
	0.4	1.5	2.0	2.5	2.0
	0.75	1.5	2.0	2.5	2.0
	1.5	1.5	2.0	2.5	2.0
	2.2	1.5	2.0	4.0	3.5
	3.0	1.5	2.0	4.0	3.5
	0.4	1.5	2.0	2.5	2.0
3 phase 500V Class	0.75	1.5	2.0	2.5	2.0
	1.5	1.5	2.0	2.5	2.0
	2.2	1.5	2.0	2.5	2.0
	4.0	1.5	2.0	2.5	2.0
	5.5	1.5	2.0	4.0	3.5
	7.5	2.5	2.0	6.0	3.5
	11	4.0	2.0	10	5.5
	15	6.0	3.5	16	5.5
	18.5	10	5.5	16	5.5

\*1: For Japan: JEAC8001-2005 compliant

Note 1: Sizes of the wires connected to the input terminals R/L1, S/L2 and T/L3 (Single-phase models are R/L1 and S/L2/N) and the output terminals U/T1, V/T2 and W/T3 when the length of each wire does not exceed 30m. If there is a need to bring the inverter into UL compliance, use wires specified in chapter 9.

Note 2: For the control circuit, use shielded wires 0.75 mm<sup>2</sup> or more in diameter.

Note 3: For grounding, use wires with a size equal to or larger than the above.

Note 4: The wire sizes specified in the above table apply to HIV wires (copper wires shielded with an insulator with a maximum allowable temperature of 75°C) used at an ambient temperature of 50°C or less.

Note 5: In case of  $P_{UL} = 2$  setting, contact your Toshiba distributor for wire size.

10

3 phase 240V class	4.0	23.8	15.9	30	20	32	20
	5.5	35.6	21.5	50	30	50	32
	7.5	46.1	28.9	60	40	60	32
	11	63.1	41.5	100	60	80	50
	15	82.1	55.7	125	75	100	60
	18.5	89.1	70.0	125	100	100	80
	1 phase 240V class	0.2	3.4	2.0	5	5	20
0.4		5.9	4.0	10	5	20	20
0.75		10.0	7.6	15	10	20	20
1.5		17.8	14.6	30	20	32	20
2.2		24.0	20.1	30	30	32	32
3.0		24.0	23.6	30	30	32	32
3 phase 500V class	0.4	2.1	0.9	5	5	20	20
	0.75	3.6	1.8	5	5	20	20
	1.5	6.4	3.4	10	5	20	20
	2.2	8.8	4.8	15	10	20	20
	4.0	13.7	8.3	20	15	20	20
	5.5	20.7	11.2	30	15	32	20
	Note 6)	7.5	26.6	15.1	40	20	32
	11	36.6	21.7	50	30	50	32
	15	47.7	29.0	60	40	60	32
	18.5	52.7	36.3	75	50	60	50

The recommended molded case circuit breaker (MCCB) must be connected to primary side of each inverter to protect the wiring system.

Note 1: Selections for use the Toshiba 4-pole standard motor with power supply voltage of 200V/ 400 - 50Hz.

Note 2: Be sure to attach a surge absorber to the exciting coil of the relay and the magnetic contactor.

Note 3: When using the auxiliary contacts 2a of the magnetic contactor MC for the control circuit, connect the contacts 2a in parallel to increase reliability.

Note 4: When a motor is driven by commercial power supply using commercial power supply / inverter switching circuit, use a magnetic contactor appropriated AC-3 class the motor rated current.

Note 5: Select an MCCB with a current breaking rating appropriate to the capacity of the power supply, because short-circuit currents vary greatly depending on the capacity of the power supply and the condition of the wiring system. The MCCB, MC and ELCB in this table were selected, on the assumption that a power supply with a normal capacity would be used.

Note 6: For the operation and control circuits, regulate the voltage at 200V to 240V with a step-down transformer for 500V class.

Note 7: In case of  $RUL = 2^2$  setting, be sure to select the wiring device for 1 rating up motor.

Note 8: Regarding influence of leakage current, refer to section 1.4.3.

## ■ Magnetic contactor in the primary circuit

To detach the inverter from the power supply in any of the following cases, insert a magnetic contactor (primary-side magnetic contactor) between the inverter and the power supply.

- (1) If the motor overload relay is tripped
- (2) If the protective detector (FL) built into the inverter is activated
- (3) In the event of a power failure (for prevention of auto-restart)
- (4) If the resistor protective relay is tripped when a braking resistor (option) is used

When using the inverter with no magnetic contactor (MC) on the primary side, install a molded-case circuit breaker with a voltage tripping coil instead of an MC and adjust the circuit breaker so that it will be tripped if the protective relay referred to above is activated. To detect a power failure, use an undervoltage relay or the like.

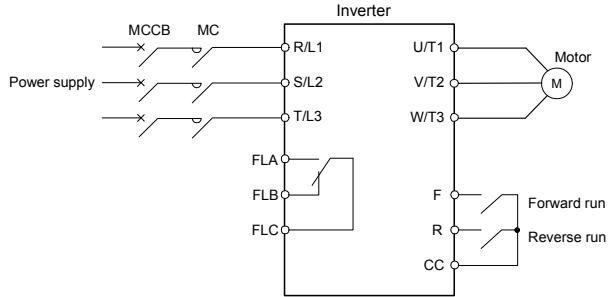

Example of connection of a magnetic contactor in the primary circuit

### Notes on wiring

- When frequently switching between start and stop, do not use the magnetic contactor on the primary side as an on-off switch for the inverter. Instead, stop and start the inverter by using terminals F and CC (forward run) or R and CC (reverse run).
- Be sure to attach a surge absorber to the exciting coil of the magnetic contactor (MC).

## 10.3 Installation of an overload relay

---

- 1) This inverter has an electronic-thermal overload protective function.  
In the following cases, however, an overload relay suitable for the adjustment of the motor electronic thermal protection level ( $t_{Hr}$ ) and appropriate to the motor used should be installed between the inverter and the motor.
  - When using a motor with a current rating different to that of the corresponding Toshiba general-purpose motor
  - When operating a single motor with an output smaller than that of the applicable standard motor or more than one motor simultaneously.
- 2) When using this inverter to operate a constant-torque motor, such as the Toshiba VF motor, adjust the protection characteristic of the electronic thermal protection unit ( $D L P$ ) to the VF motor use.
- 3) It is recommended to use a motor with a thermal relay embedded in the motor coil to give sufficient protection to the motor, especially when it runs in a low-speed range.

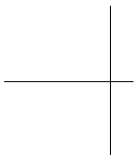

---

J-5

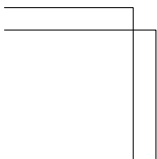

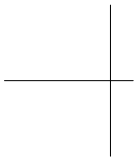

**10**

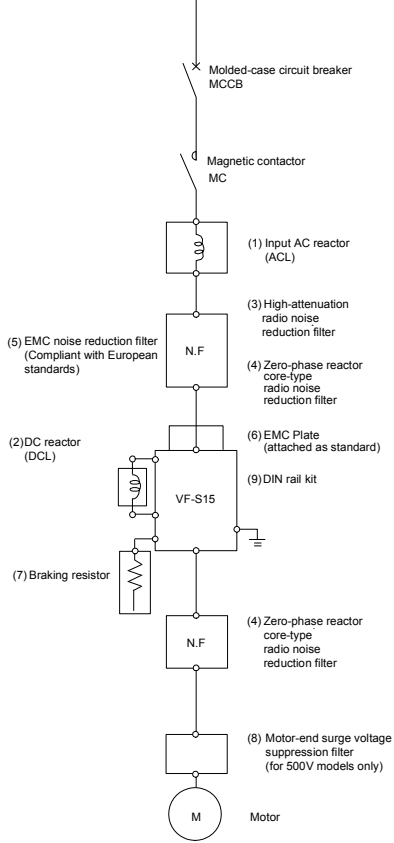

- (10) Parameter writer : RKP002Z  
PWU003Z
- (11) Extension panel : RKP007Z
- (12) Remote control panel : CBVR-7B1
- (13) Frequency meter : QS60T
- (14) FRH kit : FRH KIT
- (15) USB communication converter : USB001Z
- (16) CC-Link communication option : CCL003Z
- (17) Profibus DP communication option : PDP003Z
- (18) DeviceNet communication option : DEV003Z
- (19) EtherNet / IP-Modbus TCP communication option : IPE002Z  
IPE003Z
- (20) EtherCAT communication option : IPE003Z
- (21) CANopen communication option : CAN001Z  
CAN002Z  
CAN003Z

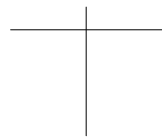
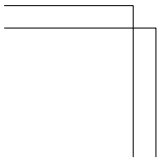



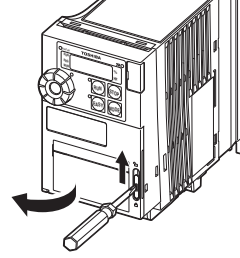
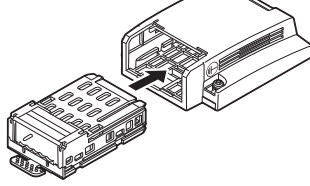

③ Remove the option connector cover on the front cover from the back side.

④ Close the front cover and lock it.

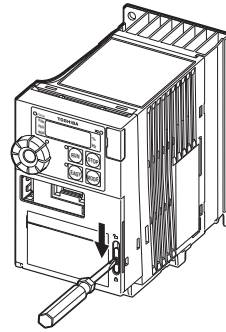
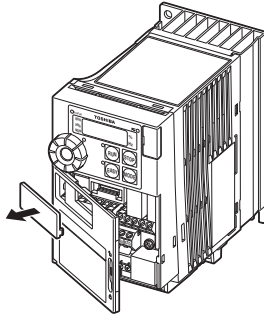

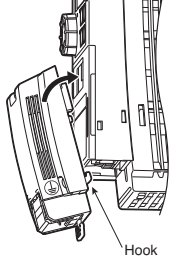

Hook

Side view

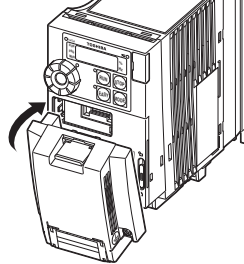

■ The option is mounted

■ How to wire the grounding cable

Wire the attached grounding cable to grounding terminal of inverter.

**10**

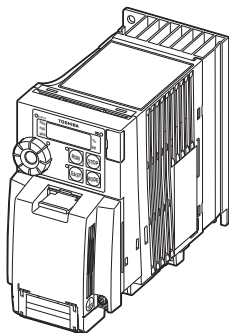

After mounting the option adapter,  
the depth increases 25.5mm.

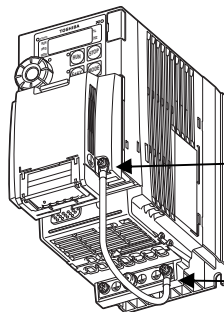

Grounding terminal of the option adapter  
Recommended tightening torque  
: 0.5N · m

Grounding terminal of the inverter

## 11.2 Basic parameters

- Five navigation functions

Title	Communication No.	Function	Unit	Minimum setting unit Panel/Communication	Adjustment range	Default setting	User setting	Reference
<i>RUH</i>	-	History function	-	-	Displays parameters in groups of five in the reverse order to that in which their settings were changed. * (Possible to edit)	-		6.1.1
<i>RUJ</i>	0090	Application easy setting *10	-	-	0: - 1: Initial easy setting 2: Conveyor 3: Material handling 4: Hoisting 5: Fan 6: Pump 7: Compressor	0		6.1.2
<i>RUJ</i>	0093	Guidance function	-	-	0: - 1: - 2: Preset speed guidance 3: - 4: Motor 1 & 2 switching operation guidance 5: Motor constant setting guidance 6: -	0		6.1.3
<i>RUJ</i>	0094	Overload characteristic selection	-	-	0: - 1: Constant torque characteristic (150%-60s) 2: Variable torque characteristic (120%-60s)	0		5.6 6.18
<i>RUJ</i>	0000	Automatic acceleration/ deceleration	-	-	0: Disabled (manual setting) 1: Automatic 2: Automatic (only at acceleration)	0		5.2 6.1.4
<i>RUJ</i>	0001	Torque boost setting macro function	-	-	0: - 1: Automatic torque boost + auto-tuning 2: Vector control + auto-tuning 3: Energy saving + auto-tuning	0		6.1.5

\*10: Refer to section 11.8 about parameters that are set by this parameter.

						1: Terminal VIA 2: Terminal VIB 3: Setting dial 2(press in center to save) 4: RS485 communication 5: UP/DOWN from external logic input 6: CANopen communication 7: Communication option 8: Terminal VIC 9, 10: - 11: Pulse train input 12, 13: - 14: $5r\bar{g}$			6.10.1 5.8 7.3
$F\bar{n}5L$	0005	Meter selection	-	-		0: Output frequency 1: Output current 2: Frequency command value 3: Input voltage (DC detection) 4: Output voltage (command value) 5: Input power 6: Output power 7: Torque 8: - 9: Motor cumulative load factor 10: Inverter cumulative load factor 11: PBR (Braking resistor) cumulative load factor 12: Stator frequency 13: VIA input value 14: VIB input value 15: Fixed output 1 (output current 100% equivalent) 16: Fixed output 2 (output current 50% equivalent) 17: Fixed output 3 (Other than the output current) 18: RS485 communication data 19: For adjustments ( $F\bar{n}$ set value is displayed.) 20: VIC input value 21: Pulse train input value 22: - 23: PID feedback value 24: Integral input power 25: Integral output power	0		5.1
$F\bar{n}$	0006	Meter adjustment gain	-	-	-		-		
$F\bar{r}$	0008	Forward/reverse run selection (Panel keypad)	-	-		0: Forward run 1: Reverse run 2: Forward run (F/R switching on extension panel) 3: Reverse run (F/R switching on extension panel)	0		6.2.2



					record clears 10, 11: - 12: Number of starting clear 13: Default setting 2 (Complete initialization)			
SEt	0099	Checking the region setting *5	-	-	0: Start setup menu 1: Japan (read only) 2: North America (read only) 3: Asia (read only) 4: Europe (read only)	*1		4.4
PSEL	0050	EASY key mode selection	-	-	0: Standard setting mode at power on 1: Easy setting mode at power on 2: Easy setting mode only	0		4.5
F1--	-	Extended parameter starting at 100	-	-	-	-	-	4.2.2
F2--	-	Extended parameter starting at 200	-	-	-	-	-	
F3--	-	Extended parameter starting at 300	-	-	-	-	-	
F4--	-	Extended parameter starting at 400	-	-	-	-	-	
F5--	-	Extended parameter starting at 500	-	-	-	-	-	
F6--	-	Extended parameter starting at 600	-	-	-	-	-	
F7--	-	Extended parameter starting at 700	-	-	-	-	-	
F8--	-	Extended parameter starting at 800	-	-	-	-	-	
F9--	-	Extended parameter starting at 900	-	-	-	-	-	
R---	-	Extended parameter starting at A	-	-	-	-	-	
C---	-	Extended parameter starting at C	-	-	-	-	-	
GRU	-	Automatic edit function	-	-	-	-	-	4.3.1

\*1: Default setting values vary depending on the setup menu setting. Refer to section 11.5.

\*5: Set "0" to activate the setup menu. Refer to section 11.5 about setting contents selected in setup menu.

F 102	0102	Speed reach detection band	Hz	0.1/0.01	0.0-F H	2.5		6.5.2 6.5.3
F 104	0104	Always active function selection 1	-	-	0-153 *6	0 (No function)		6.7.1
F 105	0105	Priority selection (Both F and R are ON)	-	-	0: Reverse 1: Deceleration Stop	1		6.6.1
F 107	0107	Analog input terminal selection (VIB)	-	-	0: 0-+10V 1: -10-+10V	0		6.6.2 6.10.2 7.3
F 108	0108	Always active function selection 2	-	-	0-153 *6	0 (No function)		6.7.1
F 109	0109	Analog/logic input selection (VIA/VIB)	-	-	0: VIA - analog input VIB - analog input 1: VIA - analog input VIB - contact input 2: - 3: VIA - contact input (Sink) VIB - contact input 4: VIA - contact input (Source) VIB - contact input	0		6.6.3 6.7.2 6.10.2 7.2.1 7.3
F 110	0110	Always active function selection 3	-	-	0-153 *6	6 (ST)		6.7.1
F 111	0111	Input terminal selection 1A (F)	-	-	0-203 *6	2 (F)		6.7.2 7.2.1
F 112	0112	Input terminal selection 2A (R)	-	-		4 (R)		
F 113	0113	Input terminal selection 3A (RES)	-	-		8 (RES)		
F 114	0114	Input terminal selection 4A (S1)	-	-		10 (SS1)		
F 115	0115	Input terminal selection 5 (S2)	-	-		12 (SS2)		
F 116	0116	Input terminal selection 6 (S3)	-	-		14 (SS3)		
F 117	0117	Input terminal selection 7 (VIB)	-	-		16 (SS4)		
F 118	0118	Input terminal selection 8 (VIA)	-	-		8-55 *6	24 (AD2)	

\*6: Refer to section 11.6 for details about input terminal function.

F 137	0137	Output terminal selection 1B (RY-RC)	-	-		255 (always ON)		
F 138	0138	Output terminal selection 2B (OUT)	-	-		255 (always ON)		
F 139	0139	Output terminal logic selection (RY-RC, OUT)	-	-	0: F 130 and F 137 F 131 and F 138 1: F 130 or F 137 F 131 and F 138 2: F 130 and F 137 F 131 or F 138 3: F 130 or F 137 F 131 or F 138	0		
F 144	0144	Input terminal response time	ms	1/1	1-1000	1		6.7.2 7.2.1
F 146	0146	Logic input / pulse train input selection (S2)	-	-	0: Logic input 1: Pulse train input	0		6.7.2 6.10.5 7.2.1
F 147	0147	Logic input / PTC input selection (S3)	-	-	0: Logic input 1: PTC input	0		2.3.2 6.7.2 6.29.16 7.2.1
F 151	0151	Input terminal selection 1B (F)	-	-	0-203 *6	0		6.7.2 7.2.1
F 152	0152	Input terminal selection 2B (R)	-	-		0		
F 153	0153	Input terminal selection 3B (RES)	-	-		0		
F 154	0154	Input terminal selection 4B (S1)	-	-		0		
F 155	0155	Input terminal selection 1C (F)	-	-		0		
F 156	0156	Input terminal selection 2C (R)	-	-		0		
F 167	0167	Frequency command agreement detection range	Hz	0.1/0.01	0.0-F H	2.5		6.24

\*6: Refer to section 11.6 for details about input terminal function.

\*7: Refer to section 11.7 for details about output terminal function.



		level 2						6.29.1
F185	0185	Stall prevention level 2	% (A)	1/1	10-199, 200 (disabled)		150	6.8.1 6.29.2
F190	0190	V/f 5-point setting VF1 frequency	Hz	0.1/0.01	0.0-FH		0.0	6.3 6.9
F191	0191	V/f 5-point setting VF1 voltage	%	0.1/0.01	0.0-125.0		0.0	
F192	0192	V/f 5-point setting VF2 frequency	Hz	0.1/0.01	0.0-FH		0.0	
F193	0193	V/f 5-point setting VF2 voltage	%	0.1/0.01	0.0-125.0		0.0	
F194	0194	V/f 5-point setting VF3 frequency	Hz	0.1/0.01	0.0-FH		0.0	
F195	0195	V/f 5-point setting VF3 voltage	%	0.1/0.01	0.0-125.0		0.0	
F196	0196	V/f 5-point setting VF4 frequency	Hz	0.1/0.01	0.0-FH		0.0	
F197	0197	V/f 5-point setting VF4 voltage	%	0.1/0.01	0.0-125.0		0.0	
F198	0198	V/f 5-point setting VF5 frequency	Hz	0.1/0.01	0.0-FH		0.0	
F199	0199	V/f 5-point setting VF5 voltage	%	0.1/0.01	0.0-125.0		0.0	

• Frequency parameters

Title	Communication No.	Function	Unit	Minimum setting unit Panel/Communication	Adjustment range	Default setting	User setting	Reference
F200	0200	Frequency priority selection	-	-	0: FFD (Switchable to F207 by terminal input) 1: FFD (Switchable to F207 at 1.0Hz or less of designated frequency)	0		5.8 6.10.1
F201	0201	VIA input point 1 setting	%	1/1	0-100	0		6.10.2 7.3
F202	0202	VIA input point 1 frequency	Hz	0.1/0.01	0.0-500.0	0.0		
F203	0203	VIA input point 2 setting	%	1/1	0-100	100		
F204	0204	VIA input point 2 frequency	Hz	0.1/0.01	0.0-500.0	*1		
F205	0205	VIA input point 1 rate	%	1/0.01	0-250	0		6.31
F206	0206	VIA input point 2 rate	%	1/0.01	0-250	100		
F207	0207	Frequency setting mode selection 2	-	-	0-14 (Same as FFD)	1		5.8 6.10.1

\*1: Default setting values vary depending on the setup menu setting. Refer to section 11.5.

\*2: Default setting values vary depending on the capacity. Refer to section 11.4.

F 2 14	0214	VIB input point 1 rate	%	1/0.01	-250-+250	0		6.31 6.32
F 2 15	0215	VIB input point 2 rate	%	1/0.01	-250-+250	100		
F 2 16	0216	VIC input point 1 setting	%	1/1	0-100	20		6.10.2 7.3
F 2 17	0217	VIC input point 1 frequency	Hz	0.1/0.01	0.0-500.0	0.0		
F 2 18	0218	VIC input point 2 setting	%	1/1	0-100	100		
F 2 19	0219	VIC input point 2 frequency	Hz	0.1/0.01	0.0-500.0	*1		
F 2 20	0220	VIC input point 1 rate	%	1/0.01	0-250	0		6.31
F 2 21	0221	VIC input point 2 rate	%	1/0.01	0-250	100		
F 2 39	0239	Factory specific coefficient 2A	-	-	-	-		* 3
F 2 40	0240	Starting frequency	Hz	0.1/0.01	0.1-10.0	0.5		6.11.1
F 2 41	0241	Operation starting frequency	Hz	0.1/0.01	0.0-F H	0.0		6.11.2
F 2 42	0242	Operation starting frequency hysteresis	Hz	0.1/0.01	0.0-F H	0.0		
F 2 43	0243	Stop frequency setting	Hz	0.1/0.01	0.0: Same as F 2 40 0.1-30.0	0.0		6.11.1
F 2 49	0249	PWM carrier frequency during DC braking	kHz	0.1/0.1	2.0-16.0	4.0		6.12.1
F 2 50	0250	DC braking starting frequency	Hz	0.1/0.01	0.0-F H	0.0		
F 2 51	0251	DC braking current	%(A)	1/1	0-100	50		
F 2 52	0252	DC braking time	s	0.1/0.1	0.0-25.5	1.0		
F 2 54	0254	Motor shaft fixing control	-	-	0: Disabled 1: Enabled (after DC braking)	0		6.12.2
F 2 55	0255	Time limit for lower-limit frequency operation	s	0.1/0.1	0: Disabled 0.1-600.0	0.0		6.13
F 2 57	0257	Factory specific coefficient 2B	-	-	-	-		* 3
F 2 58	0258	Factory specific coefficient 2C	-	-	-	-		* 3
F 2 59	0259	Lower limit frequency reach time limit at start-up	s	0.1/0.1	0.0: Disabled 0.1-600.0	0.0		6.13

\*1: Default setting values vary depending on the setup menu setting. Refer to section 11.5.

\*3: Factory specific coefficient parameters are manufacturer setting parameters. Do not change the value of these parameters.

F265	0265	External logic input - UP frequency steps	Hz	0.1/0.01	0.0-FH	0.1	
F266	0266	External logic input - DOWN response time	s	0.1/0.1	0.0-10.0	0.1	
F267	0267	External logic input - DOWN frequency steps	Hz	0.1/0.01	0.0-FH	0.1	
F268	0268	Initial value of UP/DOWN frequency	Hz	0.1/0.01	L-L-U-L	0.0	
F269	0269	Change of the initial value of UP/DOWN frequency	-	-	0: Not changed 1: Setting of F268 changed when power is turned off	1	
F270	0270	Jump frequency 1	Hz	0.1/0.01	0.0-FH	0.0	6.15
F271	0271	Jumping width 1	Hz	0.1/0.01	0.0-30.0	0.0	
F272	0272	Jump frequency 2	Hz	0.1/0.01	0.0-FH	0.0	
F273	0273	Jumping width 2	Hz	0.1/0.01	0.0-30.0	0.0	
F274	0274	Jump frequency 3	Hz	0.1/0.01	0.0-FH	0.0	
F275	0275	Jumping width 3	Hz	0.1/0.01	0.0-30.0	0.0	
F287	0287	Preset-speed frequency 8	Hz	0.1/0.01	L-L-U-L	0.0	5.7
F288	0288	Preset-speed frequency 9	Hz	0.1/0.01	L-L-U-L	0.0	
F289	0289	Preset-speed frequency 10	Hz	0.1/0.01	L-L-U-L	0.0	
F290	0290	Preset-speed frequency 11	Hz	0.1/0.01	L-L-U-L	0.0	
F291	0291	Preset-speed frequency 12	Hz	0.1/0.01	L-L-U-L	0.0	
F292	0292	Preset-speed frequency 13	Hz	0.1/0.01	L-L-U-L	0.0	
F293	0293	Preset-speed frequency 14	Hz	0.1/0.01	L-L-U-L	0.0	
F294	0294	Preset-speed frequency 15	Hz	0.1/0.01	L-L-U-L	0.0	
F295	0295	Bumpless operation selection	-	-	0: Disabled 1: Enabled	0	6.16
F297	0297	Low voltage operation upper limit frequency	Hz	0.1/0.01	0.0: Disabled 0.1-30.0	0.0	6.17
F298	0298	Low voltage operation DC voltage	Vdc	1/0.1	240V class: 72(96)-168 *11 500V class: 72(120)-336 *11	120	

\*3: Factory specific coefficient parameters are manufacturer setting parameters. Do not change the value of these parameters.

\*11: 240V class : 4.0kW or less : 72 to 168V, 5.5kW or more : 96 to 168V.

500V class : 4.0kW or less : 72 to 336V, 5.5kW or more : 120 to 336V.

F 3 0 2	0302	Regenerative power ride-through control (Deceleration stop)	-	-	0: Disabled 1: Regenerative power ride-through control 2: Deceleration stop during power failure 3: Synchronized acceleration / deceleration (signal) 4: Synchronized acceleration / deceleration (signal + power failure)	0		6.19.2
F 3 0 3	0303	Retry selection (number of times)	Times	1/1	0: Disabled 1-10	0		6.19.3
F 3 0 4	0304	Dynamic braking selection	-	-	0: Disabled 1: Enabled, Resistor overload protection enabled 2: Enabled 3: Enabled, Resistor overload protection enabled (At ST terminal on) 4: Enabled (At ST terminal on)	0		6.19.4
F 3 0 5	0305	Overvoltage limit operation (Deceleration stop mode selection)	-	-	0: Enabled 1: Disabled 2: Enabled (Quick deceleration control) 3: Enabled (Dynamic quick deceleration control)	2		6.19.5
F 3 0 7	0307	Supply voltage correction (output voltage limitation)	-	-	0: Supply voltage uncorrected, output voltage limited 1: Supply voltage corrected, output voltage limited 2: Supply voltage uncorrected, output voltage unlimited 3: Supply voltage corrected, output voltage unlimited	*1		6.19.6
F 3 0 8	0308	Dynamic braking resistance	$\Omega$	0.1/0.1	1.0-1000	*2		6.19.4
F 3 0 9	0309	Dynamic braking resistor capacity	kW	0.01/0.01	0.01-30.00	*2		
F 3 1 0	0310	Factory specific coefficient 3A	-	-	-	-		* 3
F 3 1 1	0311	Reverse-run prohibition	-	-	0: Forward/reverse run permitted 1: Reverse run prohibited 2: Forward run prohibited	0		6.19.7
F 3 1 2	0312	Random mode	-	-	0: Disabled 1: Random mode 1 2: Random mode 2 3: Random mode 3	0		6.18
F 3 1 4	0314	Factory specific coefficient 3B	-	-	-	-		* 3

\*1: Default setting values vary depending on the setup menu setting. Refer to section 11.5.

\*2: Default setting values vary depending on the capacity. Refer to section 11.4.

\*3: Factory specific coefficient parameters are manufacturer setting parameters. Do not change the value of these parameters.

		deceleration time (time elapsed between start of deceleration to stop)						
F 3 1 8	0318	Synchronized acceleration time (time elapsed between start of acceleration to achievement of specified speed)	s	0.1/0.01	0.0-3600 (360.0)	2.0		
F 3 1 9	0319	Regenerative over-excitation upper limit	%	1/1	100-160	*1		6.19.5
F 3 2 0	0320	Droop gain	%	0.1/0.1	0.0-100.0	0.0		6.20
F 3 2 3	0323	Droop insensitive torque band	%	1/1	0-100	10		
F 3 2 4	0324	Droop output filter	-	0.1/0.1	0.1-200.0	100.0		
F 3 2 5	0325	Brake releasing waiting time	s	0.01/0.01	0.00-2.50	0.00		6.22.1
F 3 2 6	0326	Brake releasing small current detection level	%	1/1	0-100	0		
F 3 2 7	0327	Factory specific coefficient 3C	-	-	-	-		* 3
F 3 2 8	0328	Light-load high-speed operation selection	-	-	0:Disabled 1:High-speed operation speed set automatically (Power running at F command: Increase) 2:High-speed operation speed set automatically (Power running at R command: Increase) 3:High-speed operation speed set with F 3 3 0 (Power running at F command: Increase) 4:High-speed operation speed set with F 3 3 0 (Power running at R command: Increase)	0		6.21
F 3 2 9	0329	Light-load high-speed learning function	-	-	0:No learning 1:Forward run learning 2:Reverse run learning	0		
F 3 3 0	0330	Automatic light-load high-speed operation frequency	Hz	0.1/0.01	30.0- $\bar{U}$ $\bar{L}$	*1		
F 3 3 1	0331	Light-load high-speed operation switching lower limit frequency	Hz	0.1/0.01	5.0- $\bar{U}$ $\bar{L}$	40.0		
F 3 3 2	0332	Light-load high-speed operation load waiting time	s	0.1/0.1	0.0-10.0	0.5		

\*1: Default setting values vary depending on the setup menu setting. Refer to section 11.5.

\*3: Factory specific coefficient parameters are manufacturer setting parameters. Do not change the value of these parameters.

F 3 3 6	0336	torque during power running Heavy-load torque during power running	%	1/0.01	-250- +250	100				
F 3 3 7	0337	Heavy-load torque during constant power running	%	1/0.01	-250- +250	50				
F 3 3 8	0338	Switching load torque during regenerative braking	%	1/0.01	-250- +250	50				
F 3 3 9	0339	Factory specific coefficient 3D	-	-	-	-				* 3
F 3 4 0	0340	Creeping time 1	s	0.01/0.01	0.00-10.00	0.00				6.22.1
F 3 4 1	0341	Braking mode selection	-	-	0: Disabled 1: Forward winding up 2: Reverse winding up 3: Horizontal operation	0				
F 3 4 2	0342	Load portion torque input selection	-	-	0: Disabled 1: Terminal VIA 2: Terminal VIB 3: Terminal VIC 4: F 3 4 3	4				
F 3 4 3	0343	Hoisting torque bias input (valid only when F 3 4 2=4)	%	1/0.01	-250- +250	100				
F 3 4 4	0344	Lowering torque bias multiplier	%	1/0.01	0-100	100				
F 3 4 5	0345	Brake release time	s	0.01/0.01	0.00-10.00	0.05				
F 3 4 6	0346	Creeping frequency	Hz	0.1/0.01	F 2 4 0 -20.0	3.0				
F 3 4 7	0347	Creeping time 2	s	0.01/0.01	0.00-10.00	0.10				
F 3 4 8	0348	Braking time learning function	-	1/1	0:Disabled 1: Learning (0 after adjustment)	0				
F 3 4 9	0349	Acceleration/deceleration suspend function	-	1/1	0:Disabled 1:Parameter setting 2:Terminal input	0				6.23
F 3 5 0	0350	Acceleration suspend frequency	Hz	0.1/0.01	0.0-F H	0.0				
F 3 5 1	0351	Acceleration suspend time	s	0.1/0.1	0.0-10.0	0.0				
F 3 5 2	0352	Deceleration suspend frequency	Hz	0.1/0.01	0.0-F H	0.0				
F 3 5 3	0353	Deceleration suspend time	s	0.1/0.1	0.0-10.0	0.0				
F 3 5 9	0359	PID control waiting time	s	1/1	0-2400	0				6.24
F 3 6 0	0360	PID control	-	-	0: Disabled 1: Process type PID control 2: Speed type PID control	0				

K-12

F 3 6 8	0368	Process lower limit	Hz	0.1/0.01	0.0-3.6	0.0		
F 3 6 9	0369	PID control feedback signal selection	-	-	0: Disabled 1: Terminal VIA 2: Terminal VIB 3: Terminal VIC 4 to 6: -	0		
F 3 7 2	0372	Process increasing rate (speed type PID control)	s	0.1/0.1	0.1-600.0	10.0		
F 3 7 3	0373	Process decreasing rate (speed type PID control)	s	0.1/0.1	0.1-600.0	10.0		
F 3 7 5	0375	Factory specific coefficient 3E	-	-	-	-		* 3
F 3 7 6	0376	Factory specific coefficient 3F	-	-	-	-		
F 3 7 8	0378	Number of pulse train input	pps	1/1	10-500	25		6.10.5
F 3 8 0	0380	PID forward/reverse characteristics selection	-	-	0: Forward 1: Reverse	0		6.24
F 3 8 2	0382	Hit and stop control	-	-	0: Disabled 1: Enabled 2: -	0		6.22.2
F 3 8 3	0383	Hit and stop control frequency	Hz	0.1/0.01	0.1-30.0	5.0		
F 3 8 4	0384	Factory specific coefficient 3G	-	-	-	-		* 3
F 3 8 5	0385	Factory specific coefficient 3H	-	-	-	-		
F 3 8 6	0386	Factory specific coefficient 3I	-	-	-	-		
F 3 8 9	0389	PID control reference signal selection	-	-	0: F I D d i f f e r e n t 1 selected 1: Terminal VIA 2: Terminal VIB 3: F P I d 4: RS485 communication 5: UP/DOWN from external logic input 6: CANopen communication 7: Communication option 8: Terminal VIC 9, 10: - 11: Pulse train input	0		6.24
F 3 9 0	0390	Factory specific coefficient 3J	-	-	-	-		* 3
F 3 9 1	0391	Hysteresis for lower-limit frequency operation	Hz	0.1/0.01	0.0-UL	0.2		6.13
F 3 9 4	0394	Factory specific coefficient 3K	-	-	-	-		* 3

\*1: Default setting values vary depending on the setup menu setting. Refer to section 11.5.

\*3: Factory specific coefficient parameters are manufacturer setting parameters. Do not change the value of these parameters.

					4: Constant torque calculation (after execution: 0)			
F 4 0 1	0401	Slip frequency gain	%	1/1	0-250	70		
F 4 0 2	0402	Automatic torque boost value	%	0.1/0.1	0.1-30.0	* 2		
F 4 0 5	0405	Motor rated capacity	kW	0.01/0.01	0.01-22.00	* 2		
F 4 1 2	0412	Motor specific coefficient 1	-	-	-	-		* 4
F 4 1 5	0415	Motor rated current	A	0.1/0.1	0.1-100.0	* 2		6.25
F 4 1 6	0416	Motor no-load current	%	1/1	10-90	* 2		
F 4 1 7	0417	Motor rated speed	min-1	1/1	100-64000	*1		
F 4 4 1	0441	Power running torque limit 1 level	%	1/0.01	0-249%, 250:Disabled	250		6.26.1
F 4 4 3	0443	Regenerative braking torque limit 1 level	%	1/0.01	0-249%, 250:Disabled	250		
F 4 4 4	0444	Power running torque limit 2 level	%	1/0.01	0-249%, 250:Disabled	250		
F 4 4 5	0445	Regenerative braking torque limit 2 level	%	1/0.01	0-249%, 250:Disabled	250		
F 4 5 1	0451	Acceleration/deceleration operation after torque limit	-	1/1	0: In sync with acceleration / deceleration 1: In sync with min. time	0		6.26.2
F 4 5 2	0452	Power running stall continuous trip detection time	s	0.01/0.01	0.00-10.00	0.00		6.26.3
F 4 5 4	0454	Constant output zone torque limit selection	-	-	0:Constant output limit 1:Constant torque limit	0		6.26.1
F 4 5 8	0458	Motor specific coefficient 2	-	-	-	-		* 4
F 4 5 9	0459	Load inertia moment ratio	Times	0.1/0.1	0.1-100.0	1.0		6.25
F 4 6 0	0460	Motor specific coefficient 3	-	-	-	-		* 4
F 4 6 1	0461	Motor specific coefficient 4	-	-	-	-		
F 4 6 2	0462	Speed reference filter coefficient	-	-	0-100	35		6.25
F 4 6 7	0467	Motor specific coefficient 5	-	-	-	-		* 4

\*1: Default setting values vary depending on the setup menu setting. Refer to section 11.5.

\*2: Default setting values vary depending on the capacity. Refer to section 11.4.

\*4: Motor specific coefficient parameters are manufacturer setting parameters. Do not change the value of these parameters.



F 4 7 4	0474	VIC input bias	-	1/1	0-255	128		
F 4 7 5	0475	VIC input gain	-	1/1	0-255			

• Torque boost parameters 2

Title	Communications No.	Function	Unit	Minimum setting unit Panel/Communication	Adjustment range	Default setting	User setting	Reference
F 4 8 0	0480	Motor specific coefficient 6	-	-	-	-		* 4
F 4 8 5	0485	Motor specific coefficient 7	-	-	-	-		
F 4 9 0	0490	Motor specific coefficient 8	-	-	-	-		
F 4 9 5	0495	Motor specific coefficient 9	-	-	-	-		
F 4 9 9	0499	Motor specific coefficient 10	-	-	-	-		

\*4: Motor specific coefficient parameters are manufacturer setting parameters. Do not change the value of these parameters.

• Acceleration/deceleration time parameters

Title	Communication No.	Function	Unit	Minimum setting unit Panel/Communication	Adjustment range	Default setting	User setting	Reference
F 5 0 0	0500	Acceleration time 2	s	0.1/0.1	0.0-3600 (360.0) *8	10.0		6.27.2
F 5 0 1	0501	Deceleration time 2	s	0.1/0.1	0.0-3600 (360.0) *8	10.0		
F 5 0 2	0502	Acceleration/deceleration 1 pattern	-	-	0: Linear 1: S-pattern 1 2: S-pattern 2	0		6.27.1
F 5 0 3	0503	Acceleration/deceleration 2 pattern	-	-		0		6.27.2
F 5 0 4	0504	Acceleration/deceleration selection (1, 2, 3) (Panel keypad)	-	-	1: Acceleration/deceleration 1 2: Acceleration/deceleration 2 3: Acceleration/deceleration 3	1		
F 5 0 5	0505	Acceleration/deceleration 1 and 2 switching frequency	Hz	0.1/0.01	0.0 (disabled) 0.1- $\frac{U_L}{L}$	0.0		
F 5 0 6	0506	S-pattern lower-limit adjustment amount	%	1/1	0-50	10		6.27.1
F 5 0 7	0507	S-pattern upper-limit adjustment amount	%	1/1	0-50	10		
F 5 1 0	0510	Acceleration time 3	s	0.1/0.1	0.0-3600 (360.0) *8	10.0		6.27.2

\*8: These parameters can be changed to 0.01s unit by setting F 5 1 9 = 1.

<i>F 5 15</i>	0515	Deceleration time at emergency stop	s	0.1/0.1	0.0-3600 (360.0) *8	10.0		6.29.4
<i>F 5 19</i>	0519	Setting of acceleration/deceleration time unit	-	-	0: - 1: 0.01s unit (after execution: 0) 2: 0.1s unit (after execution: 0)	0		5.2 6.27.2
<i>F 5 90</i>	0590	Shock monitoring	-	-	0: Disabled 1: Current detection 2: Torque detection	0		6.28
<i>F 5 91</i>	0591	Shock monitoring trip/alarm selection	-	-	0: Alarm only 1: Tripping	0		
<i>F 5 92</i>	0592	Shock monitoring detection direction selection	-	-	0: Over-current / torque detection 1: Low-current / torque detection	0		
<i>F 5 93</i>	0593	Shock monitoring detection level	%	1/1	0-250	150		
<i>F 5 95</i>	0595	Shock monitoring detection time	s	0.1/0.1	0.0-10.0	0.5		
<i>F 5 96</i>	0596	Shock monitoring detection hysteresis	%	1/1	0-100	10		
<i>F 5 97</i>	0597	Shock monitoring detection start waiting time	s	0.1/0.1	0.0-300.0	0.0		
<i>F 5 98</i>	0598	Shock monitoring detection action selection	-	-	0: During operation 1: During operation (except acceleration / deceleration)	0		

\*8: These parameters can be changed to 0.01s unit by setting *F 5 19* = 1.

## II

						4: Quick deceleration stop 5: Dynamic quick deceleration stop			
F 6 0 4	0604	DC braking time during emergency stop	s	0, 1/0, 1	0.0-20.0		1.0		
F 6 0 5	0605	Output phase failure detection selection	-	-	0: Disabled 1: At start-up (only one time after power on) 2: At start-up (each time) 3: During operation 4: At start-up + during operation 5: Detection of cutoff on output side		0		6.29.5
F 6 0 7	0607	Motor 150% overload detection time	s	1/1	10-2400		300		5.6 6.29.1
F 6 0 8	0608	Input phase failure detection selection	-	-	0: Disabled 1: Enabled		1		6.29.6
F 6 0 9	0609	Small current detection hysteresis	%	1/1	1-20		10		6.29.7
F 6 1 0	0610	Small current trip/alarm selection	-	-	0: Alarm only 1: Tripping		0		
F 6 1 1	0611	Small current detection current	% (A)	1/1	0-150		0		
F 6 1 2	0612	Small current detection time	s	1/1	0-255		0		
F 6 1 3	0613	Detection of output short-circuit at start-up	-	-	0: Each time (standard pulse) 1: Only one time after power on (standard pulse) 2: Each time (short pulse) 3: Only one time after power on (short pulse)		0		6.29.8
F 6 1 4	0614	Ground fault detection selection	-	-	0: Disabled 1: Enabled		1		6.29.9
F 6 1 5	0615	Over-torque trip/alarm selection	-	-	0: Alarm only 1: Tripping		0		6.29.10
F 6 1 6	0616	Over-torque detection level	%	1/0, 0.1	0 (disabled) 1-250		150		
F 6 1 8	0618	Over-torque detection time	s	0, 1/0, 1	0.0-10.0		0.5		
F 6 1 9	0619	Over-torque detection hysteresis	%	1/1	0-100		10		
F 6 2 0	0620	Cooling fan ON/OFF control	-	-	0: ON/OFF control 1: Always ON		0		6.29.11
F 6 2 1	0621	Cumulative operation time alarm setting	100 hours	0, 1/0, 1 (=10 hours)	0.0-999.0		876.0		6.29.12
F 6 2 5	0625	Factory specific coefficient 6A	-	-	-		-		*3
F 6 2 6	0626	Over-voltage stall protection level	%	1/1	100-150		*2		6.19.4 6.19.5

\*3: Factory specific coefficient parameters are manufacturer setting parameters. Do not change the value of these parameters.

F 6 3 2	0632	Electronic-thermal memory	-	-	0: Disabled (E H r, F 1 7 3) 1: Enabled (E H r, F 1 7 3) 2: Disabled (E H r) 3: Enabled (E H r)	0		5.8 6.29.1
F 6 3 3	0633	Analog input break detection level (VIC)	%	1/1	0: Disabled, 1-100	0		6.29.14
F 6 3 4	0634	Annual average ambient temperature (parts replacement alarms)	-	-	1: -10 to +10°C 2: 11-20°C 3: 21-30°C 4: 31-40°C 5: 41-50°C 6: 51-60°C	3		6.29.15
F 6 4 3	0643	Factory specific coefficient 6C	-	-	-	-		* 3
F 6 4 4	0644	Operation selection of analog input break detection (VIC)	-	-	0: Tripping 1: Alarm only (Coast stop) 2: Alarm only (F 5 4 9 frequency) 3: Alarm only (Maintain running) 4: Alarm only (Deceleration stop)	0		6.29.14
F 6 4 5	0645	PTC thermal selection	-	-	1: Tripping 2: Alarm only	1		6.29.16
F 6 4 6	0646	PTC detection resistor value	Ω	1/1	100-9999	3000		
F 6 4 8	0648	Number of starting alarm	10000 times	0.1/0.1	0.0-999.0	999.0		6.29.17
F 6 4 9	0649	Fallback frequency	Hz	0.1/0.01	Ł Ł - Ū Ł	0.0		6.29.14
F 6 5 0	0650	Forced fire-speed control selection	-	-	0: Disabled 1: Enabled	0		6.30
F 6 5 6	0656	Factory specific coefficient 6D	-	-	-	-		* 3
F 6 5 7	0657	Overload alarm level	%	1/1	10-100	50		5.6
F 6 6 0	0660	Override addition input selection	-	-	0: Disabled 1: Terminal VIA 2: Terminal VIB 3: Terminal VIC 4: F 7 2 9	0		6.31
F 6 6 1	0661	Override multiplication input selection	-	-	0: Disabled 1: Terminal VIA 2: Terminal VIB 3: Terminal VIC 4: F 7 2 9	0		
F 6 6 3	0663	Analog input terminal function selection (VIB)	-	-	0: Frequency command 1: Acceleration/deceleration time 2: Upper limit frequency 3, 4: - 5: Torque boost value 6: Stall prevention level 7: Motor electronic-thermal protection level 8 to 10: - 11: Base frequency	0		6.32

\*2: Default setting values vary depending on the capacity. Refer to section 11.4.

\*3: Factory specific coefficient parameters are manufacturer setting parameters. Do not change the value of these parameters.

F 6 7 5	0675	Pulse train output selection (OUT)	-	-	1: Pulse train output	0		
F 6 7 6	0676	Pulse train output function selection (OUT)	-	-	0: Output frequency 1: Output current 2: Frequency command value 3: Input voltage (DC detection) 4: Output voltage (command value) 5: Input power 6: Output power 7: Torque 8: - 9: Motor cumulative load factor 10: Inverter cumulative load factor 11: PBR (Braking resistor) cumulative load factor 12: Stator frequency 13: VIA input value 14: VIB input value 15: Fixed output 1 (output current 100% equivalent) 16: Fixed output 2 (output current 50% equivalent) 17: Fixed output 3 (Other than the output current) 18: Communication data 19: - 20: VIC input value 21, 22: - 23: PID feedback value	0		
F 6 7 7	0677	Maximum numbers of pulse train output	kpps	0.01/0.01	0.50-2.00	0.80		
F 6 7 8	0678	Pulse train output filter	ms	1/1	2-1000	64		
F 6 7 9	0679	Pulse train input filter	ms	1/1	2-1000	2		6.10.5
F 6 8 1	0681	Analog output signal selection	-	-	0: Meter option (0 to 1 mA) 1: Current (0 to 20 mA) output 2: Voltage (0 to 10 V) output	0		5.1 6.33.3
F 6 8 4	0684	Analog output filter	ms	1/1	2-1000	2		
F 6 9 1	0691	Inclination characteristic of analog output	-	-	0: Negative inclination (downward slope) 1: Positive inclination (upward slope)	1		
F 6 9 2	0692	Analog output bias	%	0.1/0.1	-1.0~+100.0	0.0		
F 6 9 3	0693	Factory specific coefficient 6E	-	-	-	-		* 3

\*3: Factory specific coefficient parameters are manufacturer setting parameters. Do not change the value of these parameters.

F 701	0701	Current/voltage unit selection	-	-	0: % 1: A (ampere)/V (volt)	0		5.10.1
F 702	0702	Frequency free unit display magnification	Times	0.01/0.01	0.00: Disabled (display of frequency) 0.01-200.0	0.00		5.10.2
F 703	0703	Frequency free unit coverage selection	-	1/1	0: All frequencies display 1: PID frequencies display	0		
F 705	0705	Inclination characteristic of free unit display	-	1/1	0: Negative inclination (downward slope) 1: Positive inclination (upward slope)	1		
F 706	0706	Free unit display bias	Hz	0.1/0.01	0.00- $FH$	0.00		
F 707	0707	Free step 1 (1-step rotation of setting dial)	Hz	0.01/0.01	0.00: Automatic 0.01- $FH$	0.00		6.34.4
F 708	0708	Free step 2 (panel display)	-	-	0: Automatic 1-255	0		
F 709	0709	Standard monitor hold function	-	-	0: Real time 1: Peak hold 2: Minimum hold	0		6.34.7

II

K-20



F 7 13	0713	Status monitor 3	-	-	9: Motor cumulative load factor 10: Inverter cumulative load factor 11: PBR (Braking resistor) cumulative load factor 12: Stator frequency (Hz/free unit) 13: VIA input value (%) 14: VIB input value (%)	3		
F 7 14	0714	Status monitor 4	-	-	15 to 17: - 18: Arbitrary code from communication 19: - 20: VIC input value (%) 21: Pulse train input value (pps) 22: -	4		
F 7 15	0715	Status monitor 5	-	-	23: PID feedback value (Hz/free unit) 24: Integral input power (kWh) 25: Integral output power (kWh) 26: Motor load factor (%) 27: Inverter load factor (%) 28: Inverter rated current (A)	5		
F 7 16	0716	Status monitor 6	-	-	29: FM output value (%) 30: Pulse train output value (pps) 31: Cumulative power on time (100 hours) 32: Cumulative fan operation time (100 hours)	6		
F 7 17	0717	Status monitor 7	-	-	33: Cumulative operation time (100 hours) 34: Number of starting (10000 times) 35: Forward number of starting (10000 times)	27		
F 7 18	0718	Status monitor 8	-	-	36: Reverse number of starting (10000 times) 37: Number of trip (times) 38, 39: - 40: Inverter rated current (Carrier frequency corrected) 41 to 51: - 52: Frequency command value / output frequency (Hz/free unit)	0		
F 7 19	0719	Selection of operation command clear	-	-	0: Clear at coast stop and retained at $\overline{P} \overline{D} F F$ 1: Retained at coast stop and $\overline{P} \overline{D} F F$ 2: Clear at coast stop and $\overline{P} \overline{D} F F$ 3: 2+ clear when $\overline{C} \overline{P} \overline{D} d$ is changed	1		6.34.8
F 7 20	0720	Initial extension panel display selection	-	-	0-52 (Same as F 7 18)	0		6.34.5
F 7 21	0721	Panel stop pattern	-	-	0: Deceleration stop 1: Coast stop	0		6.34.9
F 7 24	0724	Operation frequency setting target by setting dial	-	-	0: Panel frequency ( $F \overline{C}$ ) 1: Panel frequency ( $F \overline{C}$ ) + Preset speed frequency	0		5.7



F 732	0732	prohibition of extension panel	-	-	1: Prohibited	0		6.34.1
F 733	0733	Panel operation prohibition (RUN key)	-	-	0: Permitted 1: Prohibited	0		6.34.1
F 734	0734	Panel emergency stop operation prohibition	-	-	0: Permitted 1: Prohibited	0		
F 735	0735	Panel reset operation prohibition	-	-	0: Permitted 1: Prohibited	0		
F 736	0736	Load/FFMFD change prohibition during operation	-	-	0: Permitted 1: Prohibited	1		
F 737	0737	All key operation prohibition	-	-	0: Permitted 1: Prohibited	0		
F 738	0738	Password setting (F 700)	-	-	0: Password unset 1-9998 9999: Password set	0		
F 739	0739	Password verification	-	-	0: Password unset 1-9998 9999: Password set	0		
F 740	0740	Trace selection	-	-	0: Disabled 1: At tripping 2: At triggering 3: 1+2	1		
F 741	0741	Trace cycle	-	-	0: 4ms 1: 20ms 2: 100ms 3: 1s 4: 10s	2		
F 742	0742	Trace data 1	-	-	0-42	0		
F 743	0743	Trace data 2	-	-		1		
F 744	0744	Trace data 3	-	-		2		
F 745	0745	Trace data 4	-	-		3		
F 746	0746	Status monitor filter	ms	1/1	8-1000	200		6.34.7
F 748	0748	Integrating wattmeter retention selection	-	-	0: Disabled 1: Enabled	0		6.36
F 749	0749	Integrating wattmeter display unit selection	-	-	0:1=1kWh 1:1=10kWh 2:1=100kWh 3:1=1000kWh 4:1=10000kWh	*2		

\*2: Default setting values vary depending on the capacity. Refer to section 11.4.

F 752	0752	Easy setting mode parameter 2	-	-		4 (FMod)
F 753	0753	Easy setting mode parameter 3	-	-		9 (ACC)
F 754	0754	Easy setting mode parameter 4	-	-		10 (dEC)
F 755	0755	Easy setting mode parameter 5	-	-		12 (UL)
F 756	0756	Easy setting mode parameter 6	-	-		13 (LL)
F 757	0757	Easy setting mode parameter 7	-	-		600 (tHr)
F 758	0758	Easy setting mode parameter 8	-	-		6 (FM)
F 759	0759	Easy setting mode parameter 9	-	-		999
F 760	0760	Easy setting mode parameter 10	-	-		999
F 761	0761	Easy setting mode parameter 11	-	-		999
F 762	0762	Easy setting mode parameter 12	-	-		999
F 763	0763	Easy setting mode parameter 13	-	-		999
F 764	0764	Easy setting mode parameter 14	-	-	0-2999 (Set by communication number)	999
F 765	0765	Easy setting mode parameter 15	-	-		999
F 766	0766	Easy setting mode parameter 16	-	-		999
F 767	0767	Easy setting mode parameter 17	-	-		999
F 768	0768	Easy setting mode parameter 18	-	-		999
F 769	0769	Easy setting mode parameter 19	-	-		999
F 770	0770	Easy setting mode parameter 20	-	-		999
F 771	0771	Easy setting mode parameter 21	-	-		999
F 772	0772	Easy setting mode parameter 22	-	-		999
F 773	0773	Easy setting mode parameter 23	-	-		999
F 774	0774	Easy setting mode parameter 24	-	-		999
F 775	0775	Easy setting mode parameter 25	-	-		999
F 776	0776	Easy setting mode parameter 26	-	-		999
F 777	0777	Easy setting mode parameter 27	-	-		999

II

<i>F 7 9 0</i>	0790	Panel display selection at power on	-	-	0: <i>H E L 0</i> 1: <i>F 7 9 1</i> to <i>F 7 9 4</i> 2, 3: -	0		6.34.10
<i>F 7 9 1</i>	0791	1 <sup>st</sup> and 2 <sup>nd</sup> characters of <i>F 7 9 0</i>	hex	-	0-FFFF		2d2d	
<i>F 7 9 2</i>	0792	3 <sup>rd</sup> and 4 <sup>th</sup> characters of <i>F 7 9 0</i>	hex	-	0-FFFF		2d2d	
<i>F 7 9 3</i>	0793	5 <sup>th</sup> and 6 <sup>th</sup> characters of <i>F 7 9 0</i>	hex	-	0-FFFF		2d2d	
<i>F 7 9 4</i>	0794	7 <sup>th</sup> and 8 <sup>th</sup> characters of <i>F 7 9 0</i>	hex	-	0-FFFF		2d2d	
<i>F 7 9 9</i>	0799	Factory specific coefficient 7A	-	-	-	-	-	*3

\*3: Factory specific coefficient parameters are manufacturer setting parameters. Do not change the value of these parameters.

• Communication parameters

Title	Communication No.	Function	Unit	Minimum setting unit Panel/Communication	Adjustment range	Default setting	User setting	Reference
<i>F 8 0 0</i>	0800	Baud rate	-	-	3: 9600bps 4: 19200bps 5: 38400bps	4		6.38.1
<i>F 8 0 1</i>	0801	Parity	-	-	0: No parity 1: Even parity 2: Odd parity	1		
<i>F 8 0 2</i>	0802	Inverter number	-	1/1	0-247	0		
<i>F 8 0 3</i>	0803	Communication time-out time	s	0.1/0.1	0.0: Disabled, 0.1-100.0	0.0		
<i>F 8 0 4</i>	0804	Communication time-out action	-	-	0: Alarm only 1: Trip (Coast stop) 2: Trip (Deceleration stop)	0		
<i>F 8 0 5</i>	0805	Communication waiting time	s	0.01/0.01	0.00-2.00	0.00		
<i>F 8 0 6</i>	0806	Setting of master and slave for communication between inverters	-	-	0: Slave (0 Hz command issued in case the master inverter fails) 1: Slave (Operation continued in case the master inverter fails) 2: Slave (Emergency stop tripping in case the master inverter fails) 3: Master (transmission of frequency commands) 4: Master (transmission of output frequency signals)	0		
<i>F 8 0 8</i>	0808	Communication time-out detection condition	-	-	0: Valid at any time 1: Communication selection of <i>F 8 0 4</i> or <i>F 8 0 5</i> 2: 1+ during operation	1		

F 0 7 3	0873	command point 2 setting	-	-	0.1/0.01	0.0-FH	*1	
F 0 1 4	0814	Communication command point 2 frequency	Hz	-	0.1/0.01	0.0-FH	*1	
F 0 2 9	0829	Selection of communication protocol	-	-	-	0: Toshiba inverter protocol 1: Modbus RTU protocol	0	6.38.1
F 0 5 6	0856	Number of motor poles for communication	-	-	-	1: 2 poles 2: 4 poles 3: 6 poles 4: 8 poles 5: 10 poles 6: 12 poles 7: 14 poles 8: 16 poles	2	
F 0 7 0	0870	Block write data 1	-	-	-	0: No selection 1: Communication command 1 2: Communication command 2	0	
F 0 7 1	0871	Block write data 2	-	-	-	3: Frequency command value 4: Output data on the terminal block 5: FM analog output 6: Motor speed command	0	
F 0 7 5	0875	Block read data 1	-	-	-	0: No selection 1: Status information 1 2: Output frequency	0	
F 0 7 6	0876	Block read data 2	-	-	-	3: Output current 4: Output voltage 5: Alarm information	0	
F 0 7 7	0877	Block read data 3	-	-	-	6: PID feedback value 7: Input terminal monitor 8: Output terminal monitor	0	
F 0 7 8	0878	Block read data 4	-	-	-	9: Terminal VIA monitor 10: Terminal VIB monitor 11: Terminal VIC monitor	0	
F 0 7 9	0879	Block read data 5	-	-	-	12: Input voltage (DC detection) 13: Motor speed 14: Torque	0	
F 0 8 0	0880	Free notes	-	1/1	-	0-65530 (65535)	0	6.38.3
F 0 9 8	0898	Factory specific coefficient 8A	-	-	-	-	-	*3
F 0 9 9	0899	Communication function reset	-	-	-	0: - 1: Reset (after execution: 0)	0	6.38.1

\*1: Default setting values vary depending on the setup menu setting. Refer to section 11.5.

\*3: Factory specific coefficient parameters are manufacturer setting parameters. Do not change the value of these parameters.

<i>F 9 10</i>	0910	Step-out detection current level	%	1/1	1-150	100		6.39
<i>F 9 11</i>	0911	Step-out detection time	s	0.01/0.01	0.00: No detection 0.01-2.55	0.00		
<i>F 9 12</i>	0912	q-axis inductance	mH	0.01/0.01	0.01-650.0	10.00		6.25.2 6.39
<i>F 9 13</i>	0913	d-axis inductance	mH	0.01/0.01	0.01-650.0	10.00		
<i>F 9 14</i>	0914	Factory specific coefficient 9E	-	-	-	-		* 3
<i>F 9 15</i>	0915	Factory specific coefficient 9L	-	-	-	-		
<i>F 9 16</i>	0916	Factory specific coefficient 9F	-	-	-	-		
<i>F 9 17</i>	0917	Factory specific coefficient 9G	-	-	-	-		
<i>F 9 18</i>	0918	Factory specific coefficient 9H	-	-	-	-		
<i>F 9 19</i>	0919	Factory specific coefficient 9I	-	-	-	-		
<i>F 9 20</i>	0920	Factory specific coefficient 9J	-	-	-	-		
<i>F 9 30</i>	0930	Factory specific coefficient 9K	-	-	-	-		

\*3: Factory specific coefficient parameters are manufacturer setting parameters. Do not change the value of these parameters.

• Traverse parameters

Title	Communication No.	Function	Unit	Minimum setting unit Panel/Communication	Adjustment range	Default setting	User setting	Reference
<i>F 9 80</i>	0980	Traverse selection	-	1/1	0: Disabled 1: Enabled	0		6.40
<i>F 9 81</i>	0981	Traverse acceleration time	s	0.1/0.1	0.1-120.0	25.0		
<i>F 9 82</i>	0982	Traverse deceleration time	s	0.1/0.1	0.1-120.0	25.0		
<i>F 9 83</i>	0983	Traverse step	%	0.1/0.1	0.0-25.0	10.0		
<i>F 9 84</i>	0984	Traverse jump step	%	0.1/0.1	0.0-50.0	10.0		

C150-C199	ProfiBus DP option parameters	E6581738
C200-C249	DeviceNet option parameters	E6581737
C400-C449, C850-C899	EtherCAT option parameters	E6581818
C500-C549	EtherNet common parameters	E6581741
C550-C599	EtherNet/IP option parameters	
C600-C649	Modbus TCP option parameters	
C700-C799, C800-C830	CANopen communication parameters	E6581911

Note) Refer to each Instruction Manual for option about detailed specifications.

## 11.4 Default settings by inverter rating

Inverter type	Torque boost value	Dynamic braking resistance	Dynamic braking resistor capacity	Automatic torque boost value	Motor rated capacity	Motor rated current	Motor no-load current	Over-voltage stall protection level	Integrating wattmeter display unit selection
	$F172$ (%)	$F308$ (Ω)	$F309$ (kW)	$F402$ (%)	$F405$ (kW)	$F415$ (A)	$F416$ (%)	$F626$ (%)	$F749$
VFS15-2004PM-W	6.0	200.0	0.12	6.2	0.40	2.0	65	136	0
VFS15-2007PM-W	6.0	200.0	0.12	5.8	0.75	3.4	60	136	0
VFS15-2015PM-W	6.0	75.0	0.12	4.3	1.50	6.2	55	136	0
VFS15-2022PM-W	5.0	75.0	0.12	4.1	2.20	8.9	52	136	0
VFS15-2037PM-W	5.0	40.0	0.12	3.4	4.00	14.8	48	136	1
VFS15-2055PM-W	4.0	15.0	0.44	3.0	5.50	21.0	46	136	1
VFS15-2075PM-W	3.0	15.0	0.44	2.5	7.50	28.2	43	136	1
VFS15-2110PM-W	2.0	7.5	0.88	2.3	11.00	40.6	41	136	1
VFS15-2150PM-W	2.0	7.5	0.88	2.0	15.00	54.6	38	136	1
VFS15S-2002PL-W	6.0	200.0	0.12	8.3	0.20	1.2	70	136	0
VFS15S-2004PL-W	6.0	200.0	0.12	6.2	0.40	2.0	65	136	0
VFS15S-2007PL-W	6.0	200.0	0.12	5.8	0.75	3.4	60	136	0
VFS15S-2015PL-W	6.0	75.0	0.12	4.3	1.50	6.2	55	136	0
VFS15S-2022PL-W	5.0	75.0	0.12	4.1	2.20	8.9	52	136	0
VFS15-4004PL-W	6.0	200.0	0.12	6.2	0.40	1.0	65	141	0
VFS15-4007PL-W	6.0	200.0	0.12	5.8	0.75	1.7	60	141	0
VFS15-4015PL-W	6.0	200.0	0.12	4.3	1.50	3.1	55	141	0
VFS15-4022PL-W	5.0	200.0	0.12	4.1	2.20	4.5	52	141	0
VFS15-4037PL-W	5.0	160.0	0.12	3.4	4.00	7.4	48	141	1
VFS15-4055PL-W	4.0	60.0	0.44	2.6	5.50	10.5	46	141	1
VFS15-4075PL-W	3.0	60.0	0.44	2.3	7.50	14.1	43	141	1
VFS15-4110PL-W	2.0	30.0	0.88	2.2	11.00	20.3	41	141	1
VFS15-4150PL-W	2.0	30.0	0.88	1.9	15.00	27.3	38	141	1

\*1: When region setting is JP,  $F405$  is set to 3.7(kW).

Frequency		<i>UL1</i> <i>UL1</i> <i>F1701</i> <i>F2041</i> <i>F2131</i> <i>F2191</i> <i>F3301</i> <i>F3671</i> <i>F814</i>	50.0(Hz)	50.0(Hz)	60.0(Hz)	60.0(Hz)
Base frequency voltage 1, 2	240V class	<i>ULU/</i> <i>F171</i>	230(V)	230(V)	230(V)	200(V)
	500V class		400(V)	400(V)	460(V)	400(V)
V/F control mode selection		<i>Pt</i>	0	0	0	2
Supply voltage correction (output voltage limitation)		<i>F307</i>	2	2	2	3
Regenerative over-excitation upper limit		<i>F319</i>	120	120	120	140
Motor rated speed		<i>F417</i>	1410(min <sup>-1</sup> )	1410(min <sup>-1</sup> )	1710(min <sup>-1</sup> )	1710(min <sup>-1</sup> )

Note1) Refer to section 3.1 about setup menu.

3	FN	Inversion of forward run command	Inversion of F	7.2.1
4	R	Reverse run command	ON: Reverse run, OFF: Deceleration stop	
5	RN	Inversion of reverse run command	Inversion of R	
6	ST	Standby	ON: Ready for operation OFF: Coast stop (gate OFF)	3.1.1 5.9 6.7.1 6.34.8
7	STN	Inversion of standby	Inversion of ST	
8	RES	Reset command 1 *2	ON: Acceptance of reset command, ON → OFF: Trip reset	13.2
9	RESN	Inversion of reset command 1 *2	Inversion of RES	
10	SS1	Preset-speed command 1	Selection of 15-speed SS1 to SS4 (SS1N to SS4N) (4 bits)	5.7
11	SS1N	Inversion of preset-speed command 1		7.2.1
12	SS2	Preset-speed command 2		
13	SS2N	Inversion of preset-speed command 2		
14	SS3	Preset-speed command 3		
15	SS3N	Inversion of preset-speed command 3		
16	SS4	Preset-speed command 4		
17	SS4N	Inversion of preset-speed command 4		5.7
18	JOG	Jog run mode	ON: Jogging mode, OFF: Jog run canceled	6.14
19	JOGN	Inversion of jog run mode	Inversion of JOG	
20	EXT	Emergency stop by external signal	ON: $\bar{E}$ trip stop, OFF: After stopped by $F 6 0 3$ , $\bar{E}$ trip	6.29.4
21	EXTN	Inversion of emergency stop by external signal	Inversion of EXT	
22	DB	DC braking command	ON: DC braking, OFF: Brake canceled	6.12.1
23	DBN	Inversion of DC braking command	Inversion of DB	
24	AD2	2nd acceleration/deceleration	ON: Acceleration/deceleration 2 OFF: Acceleration/deceleration 1	6.8.1 6.27.2
25	AD2N	Inversion of 2nd acceleration/deceleration	Inversion of AD2	
26	AD3	3rd acceleration/deceleration	ON: Acceleration/deceleration 3 OFF: Acceleration/deceleration 1 or 2	
27	AD3N	Inversion of 3rd acceleration/deceleration	Inversion of AD3	
28	VF2	2nd V/F control mode switching	ON: 2nd V/F control mode (V/F fixed, $F 1 7 0$ , $F 1 7 1$ , $F 1 7 2$ , $F 1 7 3$ (t H r when $F 6 3 2 = 2$ or 3)) OFF: 1st V/F control mode (P f setting, $v 1$ , $v 2$ , $v 3$ , $v 4$ , t H r) Inversion of VF2	6.8.1
29	VF2N	Inversion of 2nd V/F control mode switching		
32	OCS2	2nd stall prevention level	ON: Enabled at the value of $F 1 0 5$ , $F 4 4 4$ and $F 4 4 5$ OFF: Enabled at the value of $F 6 0 1$ , $F 4 4 1$ and $F 4 4 3$	6.8.1 6.29.2
33	OCS2N	Inversion of 2nd stall prevention level	Inversion of OCS2	
36	PID	PID control prohibition	ON: PID control prohibited, OFF: PID control enabled	6.24
37	PIDN	Inversion of PID control prohibition	Inversion of PID	
46	OH2	External thermal error input	ON: $\bar{O} H 2$ trip stop, OFF: Disabled	7.2.1
47	OH2N	Inversion of external thermal error input	Inversion of OH2	
48	SCLC	Forced local from communication	Enabled during communication ON: Local (Setting of $\bar{C} R 0 d$ , $F R 0 d$ ) OFF: Communication	6.2.1 6.38
49	SCLCN	Inversion of forced local from communication	Inversion of SCLC	
50	HD	Operation hold (hold of 3-wire operation)	ON: F (forward run), R: (reverse run) held, 3-wire operation OFF: Deceleration stop	7.2.1
51	HDN	Inversion of operation hold (hold of 3-wire operation)	Inversion of HD	

\*2: These functions are cannot be assigned to Always active function selection 1 to 3 ( $F 1 0 4$ ,  $F 1 0 8$ ,  $F 1 1 0$ ).



58	FIRE	Fire speed operation	ON: Fire speed operation (F-2'3'4 frequency) OFF: Normal operation	
59	FIREN	Inversion of fire speed operation	Inversion of FIRE	
60	DWELL	Acceleration/deceleration suspend signal	ON: Acceleration/deceleration suspend OFF: Normal operation	6.23
61	DWELLN	Inversion of acceleration/deceleration suspend signal	Inversion of DWELL	
62	KEB	Power failure synchronized signal	ON: Deceleration stop with synchronizing when power failure OFF: Normal operation	6.19.2
63	KEBN	Inversion of power failure synchronized signal	Inversion of KEB	
64, 65	Factory specific coefficient		-	*1
70, 71	Factory specific coefficient		-	*1
74	CKWH	Integrating wattmeter(kWh) display clear	ON: Integrating wattmeter(kwh) monitor display clear OFF: Disabled	6.36
75	CKWHN	Inversion of integrating wattmeter display clear	Inversion of CKWH	
76	TRACE	Trace back trigger signal	ON: Trigger(start) signal of trace function OFF: Disabled	6.35
77	TRACEN	Inversion of trace back trigger signal	Inversion of TRACE	
78	HSLL	Light-load high-speed operation prohibitive signal	ON: Light-load high-speed operation prohibited OFF: Light-load high-speed operation permitted	6.21
79	HSLLN	Inversion of light-load high-speed operation prohibitive signal	Inversion of HSLL	
80	HDRY	Holding of RY-RC terminal output	ON: Once turned on, RY-RC are held on. OFF: The status of RY-RC changes in real time according to conditions.	7.2.2
81	HDRYN	Inversion of holding of RY-RC terminal output	Inversion of HDRY	
82	HDOUT	Holding of OUT-NO terminal output	ON: Once turned on, OUT-NO are held on. OFF: The status of OUT-NO changes in real time according to conditions.	
83	HDOUTN	Inversion of holding of OUT-NO terminal output	Inversion of HDOUT	
88	UP	Frequency UP	ON: Frequency increased OFF: Frequency increase canceled	6.10.4
89	UPN	Inversion of frequency UP	Inversion of UP	
90	DWN	Frequency DOWN	ON: Frequency decreased OFF: Frequency decrease canceled	
91	DWNN	Inversion of frequency DOWN	Inversion of DWN	
92	CLR	Clear frequency UP/DOWN	OFF → ON: Clear frequency UP/DOWN	
93	CLRN	Inversion of clear frequency UP/DOWN	Inversion of CLR	
96	FRR	Coast stop command	ON: Coast stop (Gate OFF) OFF: Coast stop canceled	3.1.1 6.34.8
97	FRRN	Inversion of coast stop command	Inversion of FRR	
98	FR	Forward/reverse selection	ON: Forward operation command OFF: Reverse operation command	7.2.1
99	FRN	Inversion of forward/reverse selection	Inversion of FR	

\*1: Factory specific coefficient parameters are manufacturer setting parameters. Do not change the value of these parameters.

107	FMTBN	Inversion of frequency setting mode terminal block	Inversion of FMTB	
108	CMTB	Command mode terminal block	ON: Terminal block enabled OFF: Setting of $\text{CMTB}$	
109	CMTBN	Inversion of command mode terminal block	Inversion of CMTB	
110	PWE	Parameter editing permission	ON: Parameter editing permitted OFF: Setting of $\text{F700}$	6.34.1
111	PWEN	Inversion of parameter editing permission	Inversion of PWE	
120	FSTP1	Fast stop command 1	ON: Dynamic quick deceleration command OFF: Forced deceleration canceled (Note that operation is resumed when forced deceleration is canceled)	6.1.4
121	FSTP1N	Inversion of fast stop command 1	Inversion of FSTP1	
122	FSTP2	Fast stop command 2	ON: Automatic deceleration OFF: Forced deceleration canceled (Note that operation is resumed when forced deceleration is canceled)	
123	FSTP2N	Inversion of fast stop command 2	Inversion of FSTP2	
134	TVS	Traverse permission signal	ON: Permission signal of traverse operation OFF: Normal operation	6.40
135	TVSN	Inversion of traverse permission signal	Inversion of TVS	
136	RSC	Low voltage operation signal	ON: Low voltage operation OFF: Low voltage operation canceled	6.17
137	RSCN	Inversion of low voltage operation signal	Inversion of RSC	
140	SLOWF	Forward deceleration	ON: Forward operation with $\text{F303}$ frequency OFF: Normal operation	6.22.2
141	SLOWFN	Inversion of forward deceleration	Inversion of SLOWF	
142	STOPF	Forward stop	ON: Forward stop, OFF: Normal operation	
143	STOPFN	Inversion of forward stop	Inversion of STOPF	
144	SLOWR	Reverse deceleration	ON: Reverse operation with $\text{F303}$ frequency OFF: Normal operation	
145	SLOWRN	Inversion of reverse deceleration	Inversion of SLOWR	
146	STOPR	Reverse stop	ON: Reverse stop, OFF: Normal operation	
147	STOPRN	Inversion of reverse stop	Inversion of STOPR	
148 to 151		Factory specific coefficient	-	*1
152	MOT2	No.2 motor switching (AD2+VF2+OCS2)	ON: No.2 motor ( $Pt=0, F170, F171, F172, F173$ ( $tHr$ when $F632=2$ or $3$ ), $F185, F500, F501, F503$ ) OFF: No.1 motor (Set value of $Pt, uL, uLu, ub, tHr, RFL, dEL, F502, F501$ )	6.8.1
153	MOT2N	Inversion of No.2 motor switching (AD2+VF2+OCS2)	Inversion of MOT2	
158	RES2	Reset command 2 *2	ON: Trip reset	13.2
159	RES2N	Inversion of reset command 2 *2	Inversion of RES2	
200	PWP	Parameter editing prohibition	ON: Parameter editing prohibited OFF: Setting of $\text{F700}$	6.34.1
201	PWPN	Inversion of parameter editing prohibition	Inversion of PWP	
202	PRWP	Parameter reading prohibition	ON: Parameter reading / editing prohibited OFF: Setting of $\text{F700}$	
203	PRWPN	Inversion of parameter reading prohibition	Inversion of PRWP	

\*1: Factory specific coefficient parameters are manufacturer setting parameters. Do not change the value of these parameters.

\*2: These functions are cannot be assigned to Always active function selection 1 to 3 ( $\text{F104}, \text{F108}, \text{F110}$ ).

Note 1: Function No. that are not described in the table above are assigned "No function".

ST	6,7	⊙	○	○	⊙	⊙	○	⊙	○	○	⊙	○	○	○	○	○	⊙
RES	8,9	○	○	○	○	○	X	○	○	○	○	○	○	○	○	○	○
SS1/ SS2/ SS3/ SS4	10,11 12,13 14,15 16,17	○	X	○	○	○	X	X	X	○	○	○	○	○	X	○	X
JOG	18,19	○	X	○	⊙	○	X	X	○	⊙	○	X	○	X	○	X	
EXT	20,21	⊙	○	⊙	⊙	⊙	⊙	○	○	○	⊙	○	○	○	○	⊙	
DB	22,23	⊙	X	○	⊙	⊙	X	○	⊙	○	⊙	○	X	○	X		
AD2/ VF2/ OCS2	24,25 28,29 32,33	○	○	○	○	○	○	○	○	○	○	○	○	○	○	○	
PID/ IDC/ PIDSW	36,37 52,53 54,55	○	○	○	○	X	○	X	○	○	○	○	○	○	○	○	
SCLC/ FMTB/ CMTB	48,49 106,107 108,109	○	○	○	○	○	○	○	○	○	○	○	○	○	○	○	
HD	50,51	○	X	○	○	X	X	X	○	○	○	○	X	○	X		
UP/ DWN/ CLR	88,89 90,91 92,93	○	○	○	○	○	○	○	○	○	○	○	○	○	○		
FRR	96,97	⊙	○	○	⊙	⊙	○	⊙	○	○	○	⊙	○	○	⊙		
PWE/ PWP	110,111 200,201	○	○	○	○	○	○	○	○	○	○	○	○	○	○		
FST	122,123	⊙	X	○	⊙	⊙	X	⊙	○	○	○	⊙	○	X	○		

⊙ Priority ○ Enabled X Disabled

2	UL	Frequency upper limit	ON: Output frequency is $UL$ or more OFF: Output frequency is less than $UL$	
3	ULN	Inversion of frequency upper limit	Inversion of UL	
4	LOW	Low-speed detection signal	ON: Output frequency is $F 100$ or more OFF: Output frequency is less than $F 100$	6.5.1 7.2.2
5	LOWN	Inversion of low-speed detection signal	Inversion of LOW	
6	RCH	Output frequency attainment signal (acceleration/deceleration completed)	ON: Output frequency is within command frequency $\pm F 102$ OFF: Output frequency is more than command frequency $\pm F 102$	6.5.2 7.2.2
7	RCHN	Inversion of output frequency attainment signal (inversion of acceleration/deceleration completed)	Inversion of RCH	
8	RCHF	Set frequency attainment signal	ON: Output frequency is within $F 101 \pm F 102$ OFF: Output frequency is more than $F 101 \pm F 102$	6.5.3
9	RCHFN	Inversion of set frequency attainment signal	Inversion of RCHF	
10	FL	Fault signal (trip output)	ON: Inverter tripped OFF: Inverter not tripped	7.2.2
11	FLN	Inversion of fault signal (inversion of trip output)	Inversion of FL	
14	POC	Over-current detection pre-alarm	ON: Output current is $F 601$ or more OFF: Output current is less than $F 601$	6.29.2
15	POCN	Inversion of over-current detection pre-alarm	Inversion of POC	
16	POL	Overload detection pre-alarm	ON: $F 657$ (%) or more of calculated value of overload protection level OFF: Less than $F 657$ (%) of calculated value of overload protection level	5.6
17	POLN	Inversion of overload detection pre-alarm	Inversion of POL	
20	POH	Overheat detection pre-alarm	ON: Approx. 95°C or more of IGBT element OFF: Less than approx. 95°C of IGBT element (90°C or less after detection is turned on)	7.2.2
21	POHN	Inversion of overheat detection pre-alarm	Inversion of POH	
22	POP	Overvoltage detection pre-alarm	ON: Overvoltage limit in operation OFF: Overvoltage detection canceled	6.19.5
23	POPn	Inversion of overvoltage detection pre-alarm	Inversion of POP	
24	MOFF	Power circuit undervoltage detection	ON: Power circuit undervoltage (MOFF) detected OFF: Undervoltage detection canceled	6.29.13
25	MOFFN	Inversion of power circuit undervoltage detection	Inversion of MOFF	
26	UC	Small current detection	ON: After output current comes to $F 611$ or less, value of less than $F 611 + F 609$ for $F 612$ set time OFF: Output current is more than $F 611$ ( $F 611 + F 609$ or more after detection turns on)	6.29.7
27	UCN	Inversion of small current detection	Inversion of UC	
28	OT	Over-torque detection	ON: After torque comes to $F 616$ or more, value of more than $F 616 - F 619$ for $F 618$ set time OFF: Torque is less than $F 616$ ( $F 616 - F 619$ or less after detection turns on)	6.29.10
29	OTN	Inversion of over-torque detection	Inversion of OT	

41	RUNN	Inversion of run/stop	Inversion of RUN	
42	HFL	Serious failure	ON: At trip *2 OFF: Other than those trip above Inversion of HFL	
43	HFLN	Inversion of serious failure		
44	LFL	Light failure	ON: At trip (0L 1~3, 0P 1~3, 0H, 0L 1~3, 0Lr) OFF: Other than those trip above Inversion of LFL	
45	LFLN	Inversion of light failure		
50	FAN	Cooling fan ON/OFF	ON: Cooling fan is in operation OFF: Cooling fan is off operation Inversion of FAN	6.29.11
51	FANN	Inversion of cooling fan ON/OFF		
52	JOG	In jogging operation	ON: In jogging operation OFF: Other than jogging operation Inversion of JOG	6.14
53	JOGN	Inversion of in jogging operation		
54	JBM	Operation panel / terminal block operation	ON: At terminal block operation command OFF: Other than those operation above Inversion of JBM	6.2.1
55	JBMN	Inversion of operation panel/terminal block operation		
56	COT	Cumulative operation time alarm	ON: Cumulative operation time is F 5 2 ! or more OFF: The cumulative operation time is less than F 5 2 ! Inversion of COT	6.29.12
57	COTN	Inversion of cumulative operation time alarm		
58	COMOP	Communication option communication error	ON: Communication error of communication option occurs OFF: Other than those above Inversion of COMOP	6.38
59	COMOPN	Inversion of communication option communication error		
60	FR	Forward/reverse run	ON: Reverse run OFF: Forward run (Operation command state is output while motor operation is stopped. No command is to OFF.) Inversion of FR	7.2.2
61	FRN	Inversion of forward/reverse run		
62	RDY1	Ready for operation 1	ON: Ready for operation (with ST / RUN) OFF: Other than those above Inversion of RDY1	
63	RDY1N	Inversion of ready for operation 1		
64	RDY2	Ready for operation 2	ON: Ready for operation (without ST / RUN) OFF: Other than those above Inversion of RDY2	
65	RDY2N	Inversion of ready for operation 2		
68	BR	Brake release	ON: Brake exciting signal OFF: Brake releasing signal Inversion of BR	6.22
69	BRN	Inversion of brake release		
70	PAL	Pre-alarm	ON: One of the following is turned on ON POL, POHR, POT, MOFF, UC, OT, LL stop, COT, and momentary power failure deceleration stop. Or C, P, Gr, H issues an alarm OFF: Other than those above Inversion of PAL	7.2.2
71	PALN	Inversion of pre-alarm		
78	COME	RS485 communication error	ON: Communication error occurred OFF: Communication works Inversion of COME	6.38
79	COMEN	Inversion of RS485 communication error		

\*2: At trip 0CL, 0CR, EPH 1, EPH0, 0t, 0t2, 0tC3, UtC3, 0H2, E, EEP 1~3, Err 2~5, UC, UP 1, Et n, Et n 1~3, EF2, PrF, EtYP, E-13, E-18~21, E-23, E-26, E-32, E-37, E-39.

108	HLD	Heavy load output	ON: Heavy load torque ( $F 3 3 5 \sim F 3 3 8$ ) or more OFF: Less than heavy load torque ( $F 3 3 5 \sim F 3 3 8$ )	
109	HLDN	Inversion of heavy load output	Inversion of HLD	
120	LLS	Lower limit frequency stop	ON: Lower limit frequency continuous operation OFF: Other than those above	6.13
121	LLSN	Inversion of lower limit frequency stop	Inversion of LLS	
122	KEB	Power failure synchronized operation	ON: Power failure synchronized operation OFF: Other than those above	6.19.2
123	KEBN	Inversion of power failure synchronized operation	Inversion of KEB	
124	TVS	Traverse in progress	ON: Traverse in progress OFF: Other than those above	6.40
125	TVSN	Inversion of traverse in progress	Inversion of TVS	
126	TVSD	Traverse deceleration in progress	ON: Traverse deceleration in progress OFF: Other than those above	
127	TVSDN	Inversion of traverse deceleration in progress	Inversion of TVSD	
128	LTA	Parts replacement alarm	ON: Any one of cooling fan, control board capacitor, or main circuit capacitor reaches parts replacement time OFF: Any one of cooling fan, control board capacitor, or main circuit capacitor does not reach parts replacement time	6.29.15
129	LTAN	Inversion of parts replacement alarm	Inversion of LTA	
130	POT	Over-torque detection pre-alarm	ON: Torque current is 70% of $F 5 1 5$ setting value or more OFF: Torque current is less than $F 5 1 5 \times 70\% - F 5 1 9$	6.29.10
131	POTN	Inversion of over-torque detection pre-alarm	Inversion of POT	
132	FMOD	Frequency setting mode selection 1/2	ON: Select frequency setting mode selection 2 ( $F 2 0 7$ ) OFF: Select frequency setting mode selection 1 ( $F 1 0 4$ )	5.8
133	FMODN	Inversion of frequency setting mode selection 1/2	Inversion of FMOD	
136	FLC	Panel / remote selection	ON: Operation command or panel OFF: Other than those above	6.2.1
137	FLCN	Inversion of panel / remote selection	Inversion of FLC	
138	FORCE	Forced continuous operation in progress	ON: Forced continuous operation in progress OFF: Other than those above	6.30
139	FORCEN	Inversion of forced continuous operation in progress	Inversion of FORCE	
140	FIRE	Specified frequency operation in progress	ON: Specified Frequency operation in progress OFF: Other than those above	
141	FIREN	Inversion of specified frequency operation in progress	Inversion of FIRE	



150	PTCA	PTC input alarm signal	ON: PTC thermal input value is $F 6 4 6$ or more OFF: PTC thermal input value is less than $F 6 4 6$	6.29.16
151	PTCAN	Inversion of PTC input alarm signal	Inversion of PTCA	
152, 153	Factory specific coefficient		-	*1
154	DISK	Analog input break detection alarm	ON: VIB terminal input value is $F 6 3 3$ or less OFF: VIB terminal input value is more than $F 6 3 3$	6.29.14
155	DISKN	Inversion of analog input break detection alarm	Inversion of DISK	
156	LI1	F terminal status	ON: F terminal is ON status OFF: F terminal is OFF status	7.2.2
157	LI1N	Inversion of F terminal status	Inversion of LI1	
158	LI2	R terminal status	ON: R terminal is ON status OFF: R terminal is OFF status	
159	LI2N	Inversion of R terminal status	Inversion of LI2	
160	LTAf	Cooling fan replacement alarm	ON: Cooling fan reaches parts replacement time OFF: Cooling fan does not reach parts replacement time	6.29.15
161	LTAfN	Inversion of cooling fan replacement alarm	Inversion of LTAf	
162	NSA	Number of starting alarm	ON: Number of starting alarm is $F 6 4 8$ or more OFF: Number of starting alarm is less than $F 6 4 8$	6.29.17
163	NSAN	Inversion of number of starting alarm	Inversion of NSA	
166	DACC	Acceleration operation in progress	ON: Acceleration operation in progress OFF: Other than those above	7.2.2
167	DACCN	Inversion of acceleration operation in progress	Inversion of DACC	
168	DDEC	Deceleration operation in progress	ON: Deceleration operation in progress OFF: Other than those above	
169	DDECN	Inversion of deceleration operation in progress	Inversion of DDEC	
170	DRUN	Constant speed operation in progress	ON: Constant speed operation in progress OFF: Other than those above	
171	DRUNN	Inversion of constant speed operation in progress	Inversion of DRUN	
172	DDC	DC braking in progress	ON: DC braking in progress OFF: Other than those above	
173	DDCN	Inversion of DC braking in progress	Inversion of DDC	6.12.1
174 to 179	Factory specific coefficient		-	*1
180	IPU	Integral input power pulse output signal	ON: Integral input power unit reach OFF: Other than those above	6.33.1
182	SMPA	Shock monitoring pre-alarm signal	ON: Current / torque value reach the shock monitoring detection condition OFF: Other than those above	6.28
183	SMPAN	Inversion of Shock monitoring pre-alarm signal	Inversion of SMPA	
222 to 253	Factory specific coefficient		-	*1
254	AOFF	Always OFF	Always OFF	7.2.2
255	ACON	Always ON	Always ON	

\*1: Factory specific coefficient parameters are manufacturer setting parameters. Do not change the value of these parameters.  
Note 1: As function No. that are not described in the table above are assigned "No function", output signal is always "OFF" at even number, output signal is always "ON" at odd number.

	setting	Conveyor	handling				Compressor
F751	CNDd	CNDd	CNDd	CNDd	CNDd	CNDd	CNDd
F752	FNDd	FNDd	FNDd	FNDd	FNDd	FNDd	FNDd
F753	RCC	RCC	RCC	RCC	RCC	RCC	RCC
F754	dEC	dEC	dEC	dEC	dEC	dEC	dEC
F755	UL	UL	UL	UL	FH	FH	FH
F756	LL	LL	LL	LL	UL	UL	UL
F757	tHr	tHr	tHr	tHr	LL	LL	LL
F758	FN	FN	FN	FN	tHr	tHr	tHr
F759	-	Pt	Pt	Pt	FN	FN	FN
F760	-	QLN	QLN	QLN	Pt	Pt	Pt
F761	-	Sr1	Sr1	F304	F201	F201	F216
F762	-	Sr2	Sr2	F308	F202	F202	F217
F763	-	Sr3	Sr3	F309	F203	F203	F218
F764	-	Sr4	Sr4	F328	F204	F204	F219
F765	-	Sr5	Sr5	F329	F207	F207	FP1d
F766	-	Sr6	Sr6	F330	F216	F216	F359
F767	-	Sr7	Sr7	F331	F217	F217	F360
F768	-	F201	F240	F332	F218	F218	F361
F769	-	F202	F243	F333	F219	F219	F362
F770	-	F203	F250	F334	F295	F295	F363
F771	-	F204	F251	F340	F301	F301	F366
F772	-	F240	F252	F341	F302	F302	F367
F773	-	F243	F304	F345	F303	F303	F368
F774	-	F250	F308	F346	F633	F610	F369
F775	-	F251	F309	F347	F667	F611	F372
F776	-	F252	F502	F400	F668	F612	F373
F777	-	F304	F506	F405	-	F633	F380
F778	-	F308	F507	F415	-	F667	F389
F779	-	F309	F701	F417	-	F668	F391
F780	-	F701	-	F648	-	-	F621
F781	F701	F702	-	F701	-	-	-
F782	P5E1	P5E1	P5E1	P5E1	P5E1	P5E1	P5E1

11



<i>RU1</i>	(Automatic acceleration/deceleration)	<i>PL</i>	(V/F control mode selection)
<i>RU2</i>	(Torque boost setting macro function)	<i>LYP</i>	(Default setting)
<i>CRD</i> *1	(Command mode selection)	<i>SEL</i>	(Checking the region setting)

[Extended parameters]

<i>F104</i> to <i>F156</i>	<i>F405</i> to <i>F417</i>
<i>F190</i> to <i>F199</i>	<i>F451</i>
<i>F207</i> / <i>F258</i> / <i>F261</i>	<i>F454</i> , <i>F458</i>
<i>F301</i> , <i>F302</i>	<i>F480</i> to <i>F495</i>
<i>F304</i> to <i>F316</i>	<i>F519</i> / <i>F603</i> / <i>F605</i> / <i>F608</i> / <i>F613</i>
<i>F319</i>	<i>F626</i> to <i>F631</i>
<i>F328</i> to <i>F330</i>	<i>F644</i> / <i>F669</i> / <i>F681</i> / <i>F750</i> / <i>F899</i>
<i>F340</i> , <i>F341</i>	<i>F909</i> to <i>F913</i>
<i>F346</i>	<i>F915</i> , <i>F916</i>
<i>F348</i> , <i>F349</i>	<i>F980</i>
<i>F360</i> / <i>F369</i>	<i>R900</i> to <i>R917</i>
<i>F375</i> to <i>F378</i>	<i>R973</i> to <i>R977</i>
<i>F389</i> / <i>F400</i>	

\*1: *CRD* and *FND* can be changed during operation by setting *F736=0*.

Note) Refer to "Communication manual" about parameter Cxxx.

Applicable motor (kW)		0.4	0.75	1.5	2.2	4.0	5.5	7.5	11	15	
Rating	Type	VFS15									
	Form	2004PM-W	2007PM-W	2015PM-W	2022PM-W	2037PM-W	2055PM-W	2075PM-W	2110PM-W	2150PM-W	
	Capacity (kVA) Note 1)	1.3	1.8	3.0	4.2	6.7	10.5	12.6	20.6	25.1	
	Rated output/current (A) Note 2)	3.3 (3.3)	4.8 (4.4)	8.0 (7.9)	11.0 (10.0)	17.5 (16.4)	27.5 (25.0)	33.0 (33.0)	54.0 (49.0)	66.0 (60.0)	
	Output voltage Note 3)	3-phase 200V to 240V									
Overload current rating	150%-60 seconds, 200%-0.5 second										
Power supply	Voltage-frequency	3-phase 200V to 240V - 50/60Hz									
	Allowable fluctuation	Voltage 170V to 264V Note 4), frequency ±5%									
	Required Power supply capacity (kVA) Note 5)	1.4	2.5	4.3	5.7	9.2	13.8	17.8	24.3	31.6	
Protection degree (IEC60529)	IP20										
Cooling method	Self-cooling				Forced air-cooled						
Color	RAL7016										
Built-in filter	Basic filter										

Item		Specification													
Input voltage		1-phase 240V					3-phase 500V								
Applicable motor (kW)		0.2	0.4	0.75	1.5	2.2	0.4	0.75	1.5	2.2	4.0	5.5	7.5	11	15
Rating	Type	VFS15S					VFS15								
	Form	2002PL-W	2004PL-W	2007PL-W	2015PL-W	2022PL-W	4004PL-W	4007PL-W	4015PL-W	4022PL-W	4037PL-W	4055PL-W	4075PL-W	4110PL-W	4150PL-W
	Capacity (kVA) Note 1)	0.6	1.3	1.8	3.0	4.2	1.1	1.8	3.1	4.2	7.2	10.9	13.0	21.1	25.1
	Rated output current (A) Note 2)	1.5 (1.5)	3.3 (3.3)	4.8 (4.4)	8.0 (7.9)	11.0 (10.0)	1.5 (1.5)	2.3 (2.1)	4.1 (3.7)	5.5 (5.0)	9.5 (8.6)	14.3 (13.0)	17.0 (17.0)	27.7 (25.0)	33.0 (30.0)
	Rated output voltage Note 3)	3-phase 200V to 240V					3-phase 380V to 500V								
Overload current rating	150%-60 seconds, 200%-0.5 second					150%-60 seconds, 200%-0.5 second									
Power supply	Voltage-current	1-phase 200V to 240V - 50/60Hz					3-phase 380V to 500V - 50/60Hz								
	Allowable fluctuation	Voltage 170V to 264V Note 4), frequency±5%					Voltage 323V to 550V Note 4), frequency ±5%								
	Required Power supply capacity (kVA) Note 5)	0.8	1.4	2.3	4.0	5.4	1.6	2.7	4.7	6.4	10.0	15.2	19.5	26.9	34.9
	Protection degree (IEC60529)	IP20													
Cooling method	Self-cooling				Forced air-cooled		Forced air-cooled								
Color	RAL7016					RAL7016									
Built-in filter	EMC filter					EMC filter									

Note 1. Capacity is calculated at 220V for the 240V models, at 440V for the 500V models.

Note 2. Indicates rated output current setting when the PWM carrier frequency (parameter  $F_{300}$ ) is 4kHz or less. When exceeding 4kHz, the rated output current setting is indicated in the parentheses. It needs to be further reduced for PWM carrier frequencies above 12 kHz.

The rated output current is reduced even further for 500V models with a supply voltage of 480V or more. The default setting of the PWM carrier frequency is 12kHz.

Note 3. Maximum output voltage is the same as the input voltage.

Note 4. At 180V-264V for the 240V models, at 342V-550V for the 500V models when the inverter is used continuously (load of 100%).

Principal control functions	Frequency accuracy	Digital setting: within $\pm 0.01\%$ of the max. frequency (-10 to +60°C) Analog setting: within $\pm 0.5\%$ of the max. frequency (25°C $\pm 10^\circ\text{C}$ )
	Voltage/frequency characteristics	V/f constant, variable torque, automatic torque boost, vector control, automatic energy-saving, dynamic automatic energy-saving control (for fan and pump), PM motor control, V/F 5-point setting, Auto-tuning. Base frequency (20-500Hz) adjusting to 1 & 2, torque boost (0-30%) adjusting to 1 & 2, adjusting frequency at start (0.1-10Hz)
	Frequency setting signal	Setting dial on the front panel, external frequency potentiometer (connectable to a potentiometer with a rated impedance of 1k-10k $\Omega$ ), 0-10Vdc / -10-+10Vdc (input impedance: 30k $\Omega$ ), 4-20mAdc (Input impedance: 250 $\Omega$ ).
	Terminal block base frequency	The characteristic can be set arbitrarily by two-point setting. Possible to set: analog input (VIA, VIB, VIC).
	Frequency jump	Three frequencies can be set. Setting of the jump frequency and the range.
	Upper- and lower-limit frequencies	Upper-limit frequency: 0.5 to max. frequency, lower-limit frequency: 0 to upper-limit frequency
	PWM carrier frequency PID control	Adjustable range of 2.0k to 16.0kHz (default: 12.0kHz). Setting of proportional gain, integral gain, differential gain and control waiting time. Checking whether the amount of processing amount and the amount of feedback agree.
Operation specifications	Acceleration/deceleration time	Selectable from among acceleration/deceleration times 1 & 2 & 3 (0.0 to 3600 sec.). Automatic acceleration/deceleration function. S-pattern acceleration/deceleration 1 & 2 and S-pattern adjustable. Control of forced rapid deceleration and dynamic rapid deceleration.
	DC braking	Braking start-up frequency: 0 to maximum frequency, braking rate: 0 to 100%, braking time: 0 to 25.5 seconds, emergency DC braking, motor shaft fixing control.
	Dynamic Braking Drive Circuit	Control and drive circuit is built in the inverter with the braking resistor outside (optional).
	Input terminal function (programmable)	Possible to select from among about 110 functions, such as forward/reverse run signal input, jog run signal input, operation base signal input and reset signal input, to assign to 8 input terminals. Logic selectable between sink and source.
	Output terminal functions (programmable)	Possible to select from among about 150 functions, such as upper/lower limit frequency signal output, low speed detection signal output, specified speed reach signal output and failure signal output, to assign to FL relay output, open collector output terminal, and RY output terminals.
	Forward/reverse run	The RUN and STOP keys on the operation panel are used to start and stop operation, respectively. Forward/reverse run possible through communication and logic inputs from the terminal block.
	Jog run	Jog mode, if selected, allows jog operation from the terminal block and also from remote keypad.
	Preset speed operation	Frequency references + 15-speed operation possible by changing the combination of 4 contacts on the terminal block.
	Retry operation	Capable of restarting automatically after a check of the main circuit elements in case the protective function is activated. 10 times (Max.) (selectable with a parameter)
	Various prohibition settings / Password setting	Possible to write-protect parameters and to prohibit the change of panel frequency settings and the use of operation panel for operation, emergency stop or resetting. Possible to write-protect parameters by setting 4 digits password and terminal input.
	Regenerative power ride-through control	Possible to keep the motor running using its regenerative energy in case of a momentary power failure (default: OFF).
	Auto-restart operation	In the event of a momentary power failure, the inverter reads the rotational speed of the coasting motor and outputs a frequency appropriate to the rotational speed in order to restart the motor smoothly. This function can also be used when switching to commercial power.
	Light-load high-speed operation	Increases the operating efficiency of the machine by increasing the rotational speed of the motor when it is operated under light load.
	Drooping function	When two or more inverters are used to operate a single load, this function prevents load from concentrating on one inverter due to unbalance.
	Override function	External input signal adjustment is possible to the operation frequency command value.
Relay output signal	1c- contact output and 1a- contact output Note2) Maximum switching capacity : 250Vac-2A , 30Vdc-2A (At resistive load $\cos\phi=1$ ), 250Vac-1A ( $\cos\phi=0.4$ ) , 30Vdc-1A (L/R=7ms) Minimum permissible load : 5Vdc-100mA, 24Vdc-5mA	

<Continued overleaf>

Display function		Up, overcurrent on the load side at start-up, CPU fault, EEPROM fault, RAM fault, ROM fault, communication error. (Selectable: dynamic braking resistor overload, emergency stop, under-voltage, small current, over-torque, low-torque, motor overload, input phase failure, output phase failure)
	Monitoring function	Output frequency, frequency command value, operation frequency command, forward/reverse run, output current, input voltage (DC detection), output voltage, torque, inverter load factor, motor load factor, braking resistor load factor, input power, output power, information on input terminals, information on output terminals, overload and region setting, version of CPU1, version of CPU2, PID feedback value, stator frequency, causes of past trips 1to 8, parts replacement alarm, cumulative operation time, number of starting
	Past trip monitoring function	Stores data on the past eight trips: number of trips that occurred in succession, output frequency, frequency command value, forward/reverse run, output current, input voltage (DC detection), output voltage, information on input terminals, information on output terminals, and cumulative operation time when each trip occurred.
	Output for frequency meter	Analog output for meter: 1mA dc full-scale dc ammeter 0 - 20mA (4 to 20mA) output: DC ammeter (allowable load resistance: Less than 600Ω) 0 - 10V output: DC voltmeter (allowable load resistance: Over 1kΩ) Maximum resolution: 1/1000
	4-digit 7-segments LED	Frequency: inverter output frequency. Alarm: stall alarm "C", overvoltage alarm "P", overload alarm "L", overheat alarm "H", communication alarm "E". Status: inverter status (frequency, cause of activation of protective function, input/output voltage, output current, etc.) and parameter settings. Free-unit display: arbitrary unit (e.g. rotating speed) corresponding to output frequency.
	Indicator	Lamps indicating the inverter status by lighting, such as RUN lamp, MON lamp, PRG lamp, % lamp, Hz lamp. The charge lamp indicates that the main circuit capacitors are electrically charged.
Environments	Location of use	Indoors, not exposed to direct sunlight, corrosive gas, explosive gas, flammable gas, oil mist, or dust, and vibration of less than 5.9m/s <sup>2</sup> (10 to 55Hz)
	Elevation	3000 m or less (current reduction required over 1000 m) Note 3)
	Ambient temperature	-10 to +60°C Note 4)
	Storage temperature	-25 to +70°C
	Relative humidity	5 to 95% (free from condensation and vapor).

Note 1. Maximum output voltage is the same as the input voltage.

Note 2. A chattering (momentary ON/OFF of contact) is generated by external factors of the vibration and the impact, etc. In particular, please set the filter of 10ms or more, or timer for measures when connecting it directly with input unit terminal of programmable controller. Please use the OUT terminal as much as possible when the programmable controller is connected.

Note 3. Current must be reduced by 1% for each 100 m over 1000 m. For example, 90% at 2000m and 80% at 3000m.

Note 4. When using the inverter in locations with temperatures above 40°C, remove the protective label on the top of the inverter and use the inverter with the output current reduced according to section 6.18.

To align the inverters side-by-side horizontally, remove the protective label on the top of the inverter before use. When using the inverter in locations with temperatures above 40°C, use the inverter with the output current reduced.

3-phase 240V	4.0	VFS15-2037PM-W	140	170	150	126	157	14	7.5	C	2.2
	5.5	VFS15-2055PM-W	150	220	170	130	210	12			D
	7.5	VFS15-2075PM-W									3.6
	11	VFS15-2110PM-W	180	310	190	160	295	20		E	6.8
	15	VFS15-2150PM-W									6.9
1-phase 240V	0.2	VFS15S-2002PL-W				101		131	7.5	A	0.8
	0.4	VFS15S-2004PL-W	72			120					1.0
	0.75	VFS15S-2007PL-W		130		135	60				1.1
	1.5	VFS15S-2015PL-W						121.5		B	1.6
	2.2	VFS15S-2022PL-W	105			150	93				1.6
3-phase 500V	0.4	VFS15-4004PL-W							7.5	B	1.4
	0.75	VFS15-4007PL-W	107	130	153	93	121.5	13			1.5
	1.5	VFS15-4015PL-W									1.5
	2.2	VFS15-4022PL-W								C	2.4
	4.0	VFS15-4037PL-W	140	170	160	126	157	14			2.6
	5.5	VFS15-4055PL-W								D	3.9
	7.5	VFS15-4075PL-W	150	220	170	130	210	12			4.0
	11	VFS15-4110PL-W								E	6.4
	15	VFS15-4150PL-W	180	310	190	160	295	20			6.5

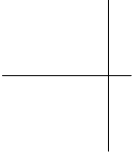

**12**

L-4

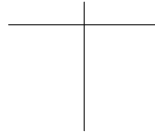
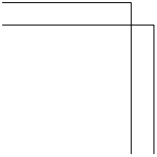

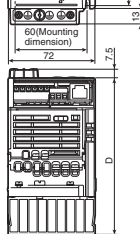

Fig.A

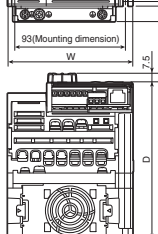
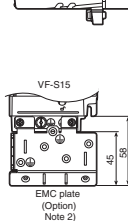
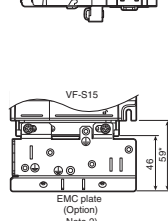

Fig.B



\*58mm for 1-phase 240V-1.5, 2.2kW models.

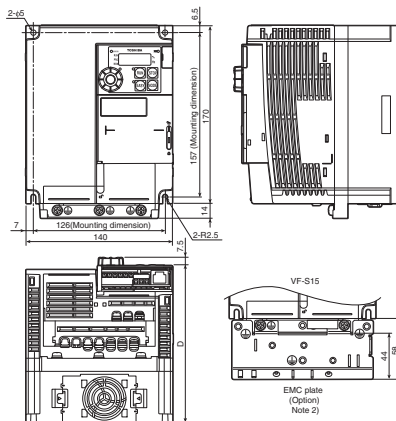

Fig.C

Note 1. To make it easier to grasp the dimensions of each inverter, dimensions common to all inverters in these figures are shown with numeric values but not with symbols.

Here are the meanings of the symbols used.

W: Width, H: Height, D: Depth

W1: Mounting dimension (horizontal)

H1: Mounting dimension (vertical)

H2: Height of EMC plate mounting area

D2: Depth of setting dial

Note 2. Here are the available EMC plate.

Fig.A : EMP007Z

Fig.B : EMP008Z

Fig.C : EMP009Z

Fig.D : EMP010Z

Fig.E : EMP011Z

Note 3. The models shown in Fig. A and Fig. B are fixed at two points: in the upper left and lower right corners.

Note 4. The model shown in Fig. A is not equipped with a cooling fan.

Note 5. The cooling fan of 1-phase 240V-1.5, 2.2kW models are on the upper side of the inverter.

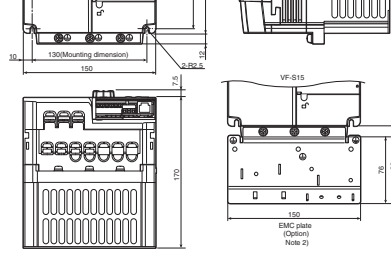

Fig.D

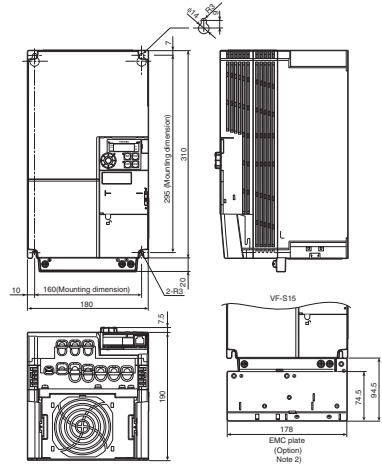

Fig.E

12

If it is found that replacement of parts is required or the problem cannot be solved in the table, contact your Toshiba distributor.

[Trip information]

Error code	Failure code	Problem	Possible causes	Remedies
<i>OC1</i>	0001	Overcurrent during acceleration	<ul style="list-style-type: none"> <li>The acceleration time <i>ACC</i> is too short.</li> <li>The V/F setting is improper.</li> <li>A restart signal is input to the rotating motor after a momentary stop, etc.</li> <li>A special motor (e.g. motor with a small impedance) is used.</li> <li>Low inductance motor especially High speed motor is used.</li> </ul>	<ul style="list-style-type: none"> <li>Increase the acceleration time <i>ACC</i>.</li> <li>Check the V/F parameter setting.</li> <li>Use <i>F301</i> (auto-restart) and <i>F302</i> (ride-through control).</li> <li>In case of <i>Pt=0, 1, 7</i>, decrease <i>ub</i>.</li> <li>In case of <i>Pt=2 to 6</i>, set <i>F415</i> (Motor rated current) and make an auto-tuning.</li> </ul>
<i>OC2</i>	0002	Overcurrent during deceleration	<ul style="list-style-type: none"> <li>Low inductance motor especially High speed motor is used.</li> </ul>	<ul style="list-style-type: none"> <li>Increase the deceleration time <i>DEC</i>.</li> <li>Choose the higher power range drive. (1 class up drive is recommended.)</li> </ul>
<i>OC3</i>	0003	Overcurrent during constant speed operation	<ul style="list-style-type: none"> <li>The load fluctuates abruptly.</li> <li>The load is in an abnormal condition.</li> <li>Low inductance motor especially High speed motor is used.</li> </ul>	<ul style="list-style-type: none"> <li>Reduce the load fluctuation.</li> <li>Check the load (operated machine).</li> <li>Choose the higher power range drive. (1 class up drive is recommended.)</li> </ul>
<i>OC4</i>	0004	Overcurrent (An overcurrent on the load side at start-up)	<ul style="list-style-type: none"> <li>The insulation of the output main circuit or motor is defective.</li> <li>The motor has too small impedance.</li> </ul>	<ul style="list-style-type: none"> <li>Check the secondary wiring and insulation state.</li> <li>Set <i>F513=2, 3</i>.</li> </ul>
<i>OCR</i>	0005	Overcurrent at start-up	<ul style="list-style-type: none"> <li>A main circuit elements is defective.</li> </ul>	<ul style="list-style-type: none"> <li>Contact your Toshiba distributor.</li> </ul>
* <i>EPH1</i>	0008	Input phase failure	<ul style="list-style-type: none"> <li>A phase failure occurred in the input line of the main circuit.</li> <li>The capacitor in the main circuit lacks capacitance.</li> </ul>	<ul style="list-style-type: none"> <li>Check the main circuit input line for phase failure.</li> <li>Check the capacitor in the main circuit for exhaustion.</li> </ul>
* <i>EPH0</i>	0009	Output phase failure	<ul style="list-style-type: none"> <li>A phase failure occurred in the output line of the main circuit.</li> </ul>	<ul style="list-style-type: none"> <li>Check the main circuit output line, motor, etc. for phase failure.</li> <li>Select output phase failure detection parameter <i>F605</i>.</li> </ul>
<i>OP1</i>	000A	Overvoltage during acceleration	<ul style="list-style-type: none"> <li>The input voltage fluctuates abnormally.</li> <li>(1) The power supply has a capacity of 500kVA or more.</li> <li>(2) A power factor improvement capacitor is opened or closed.</li> <li>(3) A system using a thyristor is connected to the same power distribution line.</li> <li>A restart signal is input to the rotating motor after a momentary stop, etc.</li> </ul>	<ul style="list-style-type: none"> <li>Insert a suitable input reactor.</li> <li>Use <i>F301</i> (auto-restart) and <i>F302</i> (ride-through control).</li> </ul>

\* This marking trips can be selected valid or invalid by parameters.

(Continued overleaf)



<i>OP3</i>	000C	Overvoltage during constant-speed operation	<ul style="list-style-type: none"> <li>to the same power distribution line.</li> <li>The input voltage fluctuates abnormally.               <ol style="list-style-type: none"> <li>(1) The power supply has a capacity of 500kVA or more.</li> <li>(2) A power factor improvement capacitor is opened or closed.</li> <li>(3) A system using a thyristor is connected to the same power distribution line.</li> </ol> </li> <li>The motor is in a regenerative state because the load causes the motor to run at a frequency higher than the inverter output frequency.</li> </ul>	<ul style="list-style-type: none"> <li>Insert a suitable input reactor.</li> <li>Install an optional dynamic braking resistor. (optional)</li> </ul>
<i>OL1</i>	000D	Inverter overload	<ul style="list-style-type: none"> <li>The acceleration time ACC is too short.</li> <li>The DC braking amount is too large.</li> <li>The V/F setting is improper.</li> <li>A restart signal is input to the rotating motor after a momentary stop, etc.</li> <li>The load is too large.</li> </ul>	<ul style="list-style-type: none"> <li>Increase the acceleration time <i>ACC</i>.</li> <li>Reduce the DC braking amount <i>F251</i> and the DC braking time <i>F252</i>.</li> <li>Check the V/F parameter setting.</li> <li>Use <i>F301</i> (auto-restart) and <i>F302</i> (ride-through control).</li> <li>Use an inverter with a larger rating.</li> </ul>
<i>OL2</i>	000E	Motor overload	<ul style="list-style-type: none"> <li>The V/F setting is improper.</li> <li>The motor is locked up.</li> <li>Low-speed operation is performed continuously.</li> <li>An excessive load is applied to the motor during operation.</li> </ul>	<ul style="list-style-type: none"> <li>Check the V/F parameter setting.</li> <li>Check the load (operated machine).</li> <li>Adjust <i>OLR</i> to the overload that the motor can withstand during operation in a low speed range.</li> </ul>
<i>OL3</i>	003E	Main module overload	<ul style="list-style-type: none"> <li>The carrier frequency is high and load current has increased at low speeds (mainly at 15Hz or less).</li> </ul>	<ul style="list-style-type: none"> <li>Raise the operation frequency.</li> <li>Reduce the load.</li> <li>Reduce the carrier frequency.</li> <li>When an operating motor is started up at 0Hz, use the auto-restart function.</li> <li>Set carrier frequency control mode selection <i>F316</i> to 1 (carrier frequency with automatic reduction).</li> </ul>
<i>OLr</i>	000F	Dynamic braking resistor overload trip	<ul style="list-style-type: none"> <li>The deceleration time is too short.</li> <li>Dynamic braking is too large.</li> </ul>	<ul style="list-style-type: none"> <li>Increase the deceleration time <i>dEL</i>.</li> <li>Increase the capacity of dynamic braking resistor (wattage) and adjust PBR capacity parameter <i>F309</i>.</li> </ul>
* <i>Ot</i>	0020	Over-torque trip 1	<ul style="list-style-type: none"> <li>Over-torque reaches to a detection level during operation.</li> </ul>	<ul style="list-style-type: none"> <li>Enable <i>F615</i> (over-torque trip selection).</li> <li>Check system error.</li> </ul>
<i>OL2</i>	0041	Over-torque trip 2	<ul style="list-style-type: none"> <li>Output current reached <i>F601</i> or more and maintain in <i>F452</i> during power running.</li> <li>Power running torque reached <i>F441</i> or more and maintain in <i>F452</i> during power running.</li> </ul>	<ul style="list-style-type: none"> <li>Reduce the load.</li> <li>Increase the stall prevention level or power running torque limit level.</li> </ul>

\* This marking trips can be selected valid or invalid by parameters.

(Continued overleaf)

			<ul style="list-style-type: none"> <li>The vent is blocked up.</li> </ul>	<ul style="list-style-type: none"> <li>Secure sufficient space around the inverter.</li> </ul>
$\overline{O}H\overline{2}$	002E	Thermal fault stop command from external device	<ul style="list-style-type: none"> <li>A thermal trip command (input terminal function: <math>\overline{4}6</math> or <math>\overline{4}7</math>) is issued by an external control device.</li> </ul>	<ul style="list-style-type: none"> <li>The motor is overheated, so check whether the current flowing into the motor exceeds the rated current.</li> </ul>
$\overline{E}$	0011	Emergency stop	<ul style="list-style-type: none"> <li>During automatic operation or remote operation, a stop command is entered from the operation panel or a remote input device.</li> </ul>	<ul style="list-style-type: none"> <li>Reset the inverter.</li> <li>If the emergency stop signal is input, reset after releasing this signal.</li> </ul>
$\overline{E}EP\overline{1}$	0012	EEPROM fault 1	<ul style="list-style-type: none"> <li>A data writing error occurs.</li> </ul>	<ul style="list-style-type: none"> <li>Turn off the inverter, then turn it again. If it does not recover from the error, contact your Toshiba distributor.</li> </ul>
$\overline{E}EP\overline{2}$	0013	EEPROM fault 2	<ul style="list-style-type: none"> <li>Power supply is cut off during <math>\overline{E}P</math> operation and data writing is aborted.</li> <li>The error occurred when various data was written.</li> </ul>	<ul style="list-style-type: none"> <li>Turn the power off temporarily and turn it back on, and then try <math>\overline{E}P</math> operation again.</li> <li>Write the data again. Contact your Toshiba distributor when it happening frequently.</li> </ul>
$\overline{E}EP\overline{3}$	0014	EEPROM fault 3	<ul style="list-style-type: none"> <li>A data reading error occurred.</li> </ul>	<ul style="list-style-type: none"> <li>Turn off the inverter, then turn it again. If it does not recover from the error, contact your Toshiba distributor.</li> </ul>
$\overline{E}rr\overline{2}$	0015	Main unit RAM fault	<ul style="list-style-type: none"> <li>The control RAM is defective.</li> </ul>	<ul style="list-style-type: none"> <li>Contact your Toshiba distributor.</li> </ul>
$\overline{E}rr\overline{3}$	0016	Main unit ROM fault	<ul style="list-style-type: none"> <li>The control ROM is defective.</li> </ul>	<ul style="list-style-type: none"> <li>Contact your Toshiba distributor.</li> </ul>
$\overline{E}rr\overline{4}$	0017	CPU fault 1	<ul style="list-style-type: none"> <li>The control CPU is defective.</li> </ul>	<ul style="list-style-type: none"> <li>Contact your Toshiba distributor.</li> </ul>
$\overline{E}rr\overline{5}$	0018	Communication error	<ul style="list-style-type: none"> <li>The communication was broken off.</li> </ul>	<ul style="list-style-type: none"> <li>Check the remote control device, cables, etc.</li> </ul>
$\overline{E}rr\overline{7}$	001A	Current detector fault	<ul style="list-style-type: none"> <li>The current detector is defective.</li> </ul>	<ul style="list-style-type: none"> <li>Contact your Toshiba distributor.</li> </ul>
$\overline{E}rr\overline{8}$	001B	Optional unit fault 1	<ul style="list-style-type: none"> <li>An optional unit has failed. (such as a communication option)</li> </ul>	<ul style="list-style-type: none"> <li>Check the connection of optional unit.</li> </ul>
$\overline{E}rr\overline{9}$	001C	Remote keypad disconnection fault	<ul style="list-style-type: none"> <li>After run signal is activated by RUN key of the remote keypad, disconnection is occurred in 10 seconds or more.</li> </ul>	<ul style="list-style-type: none"> <li>In case the remote keypad is disconnected, press STOP key before.</li> <li>This fault is disabled by <math>F\overline{7}\overline{3}i=1</math> setting.</li> </ul>
* $\overline{U}C$	001D	Low-current operation fault	<ul style="list-style-type: none"> <li>The output current decreased to a low-current detection level during operation.</li> </ul>	<ul style="list-style-type: none"> <li>Enable <math>F\overline{6}i\overline{0}</math> (low-current detection).</li> <li>Check the suitable detection level for the system (<math>F\overline{6}0\overline{9}</math>, <math>F\overline{6}i1</math>, <math>F\overline{6}i\overline{2}</math>).</li> <li>Contact your Toshiba distributor if the setting is correct.</li> </ul>
* $\overline{U}P\overline{1}$	001E	Undervoltage fault (main circuit)	<ul style="list-style-type: none"> <li>The input voltage (in the main circuit) is too low.</li> </ul>	<ul style="list-style-type: none"> <li>Check the input voltage.</li> <li>Enable <math>F\overline{6}\overline{2}7</math> (undervoltage trip selection).</li> <li>To take measures to momentary power failure, set <math>F\overline{6}\overline{2}7=0</math>, Regenerative power ride-through control <math>F\overline{3}0\overline{2}</math> and Auto-restart control selection <math>F\overline{3}0\overline{1}</math>.</li> </ul>

\* This marking trips can be selected valid or invalid by parameters.

(Continued overleaf)

			<ul style="list-style-type: none"> <li>• Those of three-phase induction motors.</li> <li>• The motor is not connected.</li> <li>• The motor is rotating.</li> </ul>	<ul style="list-style-type: none"> <li>• Connect the motor.</li> <li>• Check whether the secondary magnetic contactor.</li> <li>• Make an auto-tuning again after the rotation of the motor stops.</li> <li>• Choose the higher power range drive. (1 class up drive is recommended.)</li> </ul>
<i>E F 2</i>	0022	Ground fault	<ul style="list-style-type: none"> <li>• A ground fault occurs in the output cable or the motor.</li> <li>• Overcurrent of dynamic braking resistor</li> </ul>	<ul style="list-style-type: none"> <li>• Check the cable and the motor for ground faults.</li> <li>• Increase the deceleration time <i>d E 1</i>.</li> <li>• Set the supply voltage correction <i>F 3 0 7</i> to 1 or 3.</li> <li>• Set the parameter <i>F 6 1 4</i> to 0 "Disabled".</li> </ul>
* <i>S O U L</i>	002F	Step-out (for PM motor drive only)	<ul style="list-style-type: none"> <li>• The motor shaft is locked.</li> <li>• One output phase is open.</li> <li>• An impact load is applied.</li> <li>• Using the DC braking function.</li> </ul>	<ul style="list-style-type: none"> <li>• Unlock the motor shaft.</li> <li>• Check the interconnect cables between the inverter and the motor.</li> <li>• Prolong the acceleration / deceleration time.</li> <li>• Turn off the Step-out function when using the DC braking function or change the DC braking to Servo lock function.</li> </ul>
<i>E t 4 P</i>	0029	Inverter type error	<ul style="list-style-type: none"> <li>• It may be a breakdown failure.</li> </ul>	<ul style="list-style-type: none"> <li>• Contact your Toshiba distributor.</li> </ul>
<i>E - 1 3</i>	002D	Over speed fault	<ul style="list-style-type: none"> <li>• The input voltage fluctuates abnormally.</li> <li>• Over speed fault due to the overvoltage limit operation.</li> </ul>	<ul style="list-style-type: none"> <li>• Check the input voltage.</li> <li>• Install an optional dynamic braking resistor. (optional)</li> </ul>
* <i>E - 1 8</i>	0032	Analog input break detection fault	<ul style="list-style-type: none"> <li>• The input signal from VIC is equal to or less than the <i>F 6 3 3</i> setting.</li> </ul>	<ul style="list-style-type: none"> <li>• Check the VIC signal cable for breaks. Also, check the input signal value or setting of <i>F 6 3 3</i>.</li> </ul>
<i>E - 1 9</i>	0033	CPU communications error	<ul style="list-style-type: none"> <li>• A communications error occurs between control CPUs.</li> </ul>	<ul style="list-style-type: none"> <li>• Contact your Toshiba distributor.</li> </ul>
<i>E - 2 0</i>	0034	Over torque boost fault	<ul style="list-style-type: none"> <li>• The automatic torque boost parameter <i>F 4 0 2</i> setting is too high.</li> <li>• The motor has too small impedance.</li> </ul>	<ul style="list-style-type: none"> <li>• Set a lower automatic torque boost parameter <i>F 4 0 2</i> setting.</li> <li>• Make an auto-tuning.</li> </ul>
<i>E - 2 1</i>	0035	CPU fault 2	<ul style="list-style-type: none"> <li>• The control CPU is defective.</li> </ul>	<ul style="list-style-type: none"> <li>• Contact your Toshiba distributor.</li> </ul>
<i>E - 2 3</i>	0037	Optional unit fault 2	<ul style="list-style-type: none"> <li>• An optional device is defective.</li> </ul>	<ul style="list-style-type: none"> <li>• Contact your Toshiba distributor.</li> </ul>
<i>E - 2 6</i>	003A	CPU fault 3	<ul style="list-style-type: none"> <li>• The control CPU is defective.</li> </ul>	<ul style="list-style-type: none"> <li>• Contact your Toshiba distributor.</li> </ul>
<i>E - 2 7</i>	0057	Internal circuit fault	<ul style="list-style-type: none"> <li>• Internal circuit is defective.</li> </ul>	<ul style="list-style-type: none"> <li>• Contact your Toshiba distributor.</li> </ul>
<i>E - 3 2</i>	0040	PTC fault	<ul style="list-style-type: none"> <li>• PTC thermal protection is occurred.</li> </ul>	<ul style="list-style-type: none"> <li>• Check the PTC in motor.</li> </ul>
<i>E - 3 7</i>	0045	Servo lock fault	<ul style="list-style-type: none"> <li>• The motor shaft is not locked in servo lock operation.</li> </ul>	<ul style="list-style-type: none"> <li>• Reduce the load in servo lock operation.</li> </ul>

\* This marking trips can be selected valid or invalid by parameters.

(Continued overleaf)

<i>OFF</i>	Standby function/ terminal OFF	<ul style="list-style-type: none"> <li>The supply voltage between R, S and T is under voltage.</li> <li>Internal communication fault.</li> </ul>	<ul style="list-style-type: none"> <li>Measure the main circuit supply voltage. If the voltage is at a normal level, the inverter requires repairing for fault.</li> </ul>
<i>rtRY</i>	Retry in process	<ul style="list-style-type: none"> <li>The inverter is in process of retry.</li> <li>A momentary stop occurred. The motor speed is being detected.</li> </ul>	<ul style="list-style-type: none"> <li>The inverter restarts automatically. Be careful of the machine because it may suddenly restart.</li> </ul>
<i>Err 1</i>	Frequency point setting error alarm	<ul style="list-style-type: none"> <li>The frequency setting signals at points 1 and 2 are set too close to each other.</li> </ul>	<ul style="list-style-type: none"> <li>Set the frequency setting signals at points 1 and 2 apart from each other.</li> </ul>
<i>CLR</i>	Clear command acceptable	<ul style="list-style-type: none"> <li>This message is displayed when pressing the STOP key while an error code is displayed.</li> </ul>	<ul style="list-style-type: none"> <li>Press the STOP key again to clear the trip.</li> </ul>
<i>EOFF</i>	Emergency stop command acceptable	<ul style="list-style-type: none"> <li>The operation panel is used to stop the operation in automatic control or remote control mode.</li> </ul>	<ul style="list-style-type: none"> <li>Press the STOP key for an emergency stop. To cancel the emergency stop, press any other key.</li> </ul>
<i>H LL</i> <i>LD</i>	Setting error alarm / An error code and data are displayed alternately twice each.	<ul style="list-style-type: none"> <li>An error is found in a setting when data is reading or writing.</li> </ul>	<ul style="list-style-type: none"> <li>Check whether the setting is made correctly.</li> </ul>
<i>HEAD/</i> <i>End</i>	Display of first/last data items	<ul style="list-style-type: none"> <li>The first and last data item in the <i>RUH</i> data group is displayed.</li> </ul>	<ul style="list-style-type: none"> <li>Press MODE key to exit the data group.</li> </ul>
<i>db</i>	DC braking	<ul style="list-style-type: none"> <li>DC braking in process</li> </ul>	<ul style="list-style-type: none"> <li>The message goes off in several tens of seconds if no problem occurs. Note 1)</li> </ul>
<i>E 1</i> <i>E 2</i> <i>E 3</i>	Flowing out of excess number of digits	<ul style="list-style-type: none"> <li>The number of digits such as frequencies is more than 4. (The upper digits have a priority.)</li> </ul>	<ul style="list-style-type: none"> <li>Lower the frequency free unit magnification <i>F 702</i>.</li> </ul>
<i>STOP</i>	Momentary power failure deceleration stop prohibition function activated.	<ul style="list-style-type: none"> <li>The slowdown stop prohibition function set with <i>F 302</i> (momentary power failure ride-through operation) is activated.</li> </ul>	<ul style="list-style-type: none"> <li>To restart operation, reset the inverter or input an operation signal again.</li> </ul>
<i>LSEP</i>	Auto-stop because of continuous operation at the lower-limit frequency	<ul style="list-style-type: none"> <li>The automatic stop function selected with <i>F 255</i> was activated.</li> </ul>	<ul style="list-style-type: none"> <li>This function is cancelled, when frequency reference reaches LL+0.2Hz or operation command is OFF.</li> </ul>
<i>init</i>	Parameters in the process of initialization	<ul style="list-style-type: none"> <li>Parameters are being initialized to default values.</li> </ul>	<ul style="list-style-type: none"> <li>Normal if the message disappears after a while (several seconds to several tens of seconds).</li> </ul>
<i>R-01</i>	Points setting alarm 1	<ul style="list-style-type: none"> <li>In case of <math>P\ell = 7</math>, there are same setting value at least two on parameter <math>\omega L</math>, <i>F 190</i>, <i>F 192</i>, <i>F 194</i>, <i>F 196</i>, or <i>F 198</i> except 0.0Hz.</li> </ul>	<ul style="list-style-type: none"> <li>Set the points to different values.</li> </ul>
<i>R-02</i>	Points setting alarm 2	<ul style="list-style-type: none"> <li>In case of <math>P\ell = 7</math>, the inclination of <math>V/f</math> is too high.</li> </ul>	<ul style="list-style-type: none"> <li>Set the inclination of <math>V/f</math> to be flat.</li> </ul>

Note 1) When the DC braking (DB) function is assigned by using the input terminal function 22 or 23, it is normal if "db" disappears when opening the circuit between the terminal and CC(or P24).

(Continued overleaf)

		settings are different.	Power supply OFF and ON after these settings.
<i>R E n</i>	Auto-tuning	• Auto-tuning in process	• Normal if it the message disappears after a few seconds.
<i>R L 0 5</i>	Break in analog signal cable	• The signal input via VIC is below the analog signal detection level set with <i>F 6 3 3</i> and setting value of <i>F 6 4 4</i> is one or more.	• Check the cables for breaks. And check the setting of input signal or setting value of <i>F 6 3 3</i> and <i>F 6 4 4</i> .
<i>F i r E</i>	In forced operation	• " <i>F i r E</i> " and operation frequency is displayed alternately in operation of forced fire-speed control.	• It is normal the alarm is gone out after the forced fire-speed control operation.
<i>P R 5 5 / F R 1 L</i>	Password verification result	• After the password setting ( <i>F 7 3 8</i> ), the password was input to <i>F 7 3 9</i> (password verification).	• If the password is correct, <i>P R 5 5</i> is displayed and if it is incorrect, <i>F R 1 L</i> is displayed.
<i>E R 5 4 / 5 E d</i>	Switching display of Easy setting mode / Standard setting mode	• The EASY key was pushed in the standard monitor mode.	• When <i>E R 5 4</i> is displayed, setting mode becomes easy setting mode. When <i>5 E d</i> is displayed, it becomes standard setting mode.
<i>5 E t</i> Note 2)	Input requirement of region setting	• A region setting is not input yet. • Power supplied to the inverter at first time • As checking the region setting parameter <i>5 E t</i> is set to <i>0</i> , inverter return to default setting. • As <i>t 4 P</i> is set to <i>1 3</i> , inverter return to default setting.	• Set a region setting by using setting dial. Refer to section 3.1.
<i>n E r r</i>	No trip of past trip	• No new record of past trip, after past trips were clear.	• Normal operation.
<i>n - -</i>	No detailed information of past trip	• The detailed information of past trip is read by pushing the center of setting dial during blinking <i>n E r r</i> ⇔ number.	• Normal operation. To be returned by pressing MODE key.

Note 2) *5 E t* is blinking after power supply is on. In this time, the keys are not operated.  
But parameter *5 E t* is lighting as same as other parameters and is not blinking.

[Prealarm display]

<i>E</i>	Overcurrent alarm	Same as <i>0 E</i> (overcurrent)
<i>P</i>	Overvoltage alarm	Same as <i>0 P</i> (overvoltage)
<i>L</i>	Overload alarm	Same as <i>0 L 1</i> and <i>0 L 2</i> (overload)
<i>H</i>	Overheat alarm	Same as <i>0 H</i> (overheat)
<i>t</i>	Communication alarm	Same as <i>E r r 5</i> (communication fault)

If two or more problems arise simultaneously, one of the following alarms appears and blinks.

*E P, P L, E P L*

The blinking alarms *E, P, L, H, t* are displayed in this order from left to right.

Note) See inverter trip hold selection  $F502$  for details.

- (2) By means of an external signal (Short circuit across RES and CC (or P24) on control terminal block → Open): The reset function must be assigned to the input terminal block. (function number 8, 9)
- (3) By panel keypad operation
- (4) By inputting a trip clear signal from communication  
(Refer to communication manual (E6581913) for details.)

To reset the inverter by panel keypad operation, follow these steps.

1. Press the STOP key and make sure that  $Lr$  is displayed.
2. Pressing the STOP key again will reset the inverter if the cause of the trip has already been eliminated.

- ★ When any overload function [ $OL1$ : inverter overload,  $OL2$ : motor overload,  $OL3$ : main module overload,  $OLr$ : braking resistor overload] is active, the inverter cannot be reset by inputting a reset signal from an external device or by operation panel operation before the virtual cooling time has passed.

Virtual cooling time ...  $OL1$ : about 30 seconds after the occurrence of a trip

$OL2$ : about 120 seconds after a occurrence of a trip

$OLr$ : about 20 seconds after a occurrence of a trip

- ★ As to  $OL3$  (Main module overload), there is no virtual cooling time.
- ★ In case of a trip due to overheat ( $OH$ ), the inverter checks the temperature within. Wait until the temperature in the inverter falls sufficiently before resetting the inverter.
- ★ The inverter cannot be reset while the emergency stop signal is being input from the terminal.
- ★ The inverter cannot be reset while the pre-alarm is occurred.

[Caution]

Turning the inverter off then turning it on again resets the inverter immediately. You can use this mode of resetting if there is a need to reset the inverter immediately. Note, however, that this operation may damage the system or the motor if it is repeated frequently.

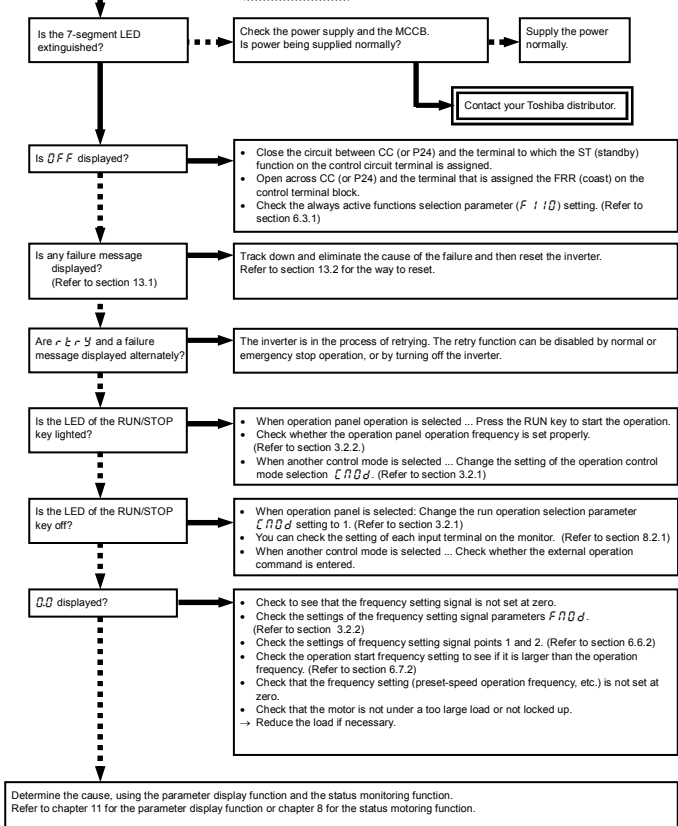

13

<p>The motor runs but its speed does not change normally.</p>	<ul style="list-style-type: none"> <li>The load is too heavy. Reduce the load.</li> <li>The soft stall function is activated. Disable the soft stall function. (Refer to section 3.5)</li> <li>The maximum frequency <math>FH</math> and the upper limit frequency <math>UL</math> are set too low. Increase the maximum frequency <math>FH</math> and the upper limit frequency <math>UL</math>.</li> <li>The frequency setting signal is too low. Check the signal set value, circuit, cables, etc.</li> <li>Check the setting characteristics (point 1 and point 2 settings) of the frequency setting signal parameters. (Refer to section 6.6.2)</li> <li>If the motor runs at a low speed, check to see that the stall prevention function is activated because the torque boost value is too large. Adjust the torque boost value (<math>\mu b</math>) and the acceleration time (<math>RLL</math>). (Refer to section 5.13 and 5.4)</li> </ul>
<p>The motor does not accelerate or decelerate smoothly.</p>	<ul style="list-style-type: none"> <li>The acceleration time (<math>RLL</math>) or the deceleration time (<math>dEL</math>) is set too short. Increase the acceleration time (<math>RLL</math>) or the deceleration time (<math>dEL</math>).</li> </ul>
<p>A too large current flows into the motor.</p>	<ul style="list-style-type: none"> <li>The load is too heavy. Reduce the load.</li> <li>If the motor runs at a low speed, check whether the torque boost value is too large. (Refer to section 5.13)</li> </ul>
<p>The motor runs at a higher or lower speed than the specified one.</p>	<ul style="list-style-type: none"> <li>The motor has an improper voltage rating. Use a motor with a proper voltage rating.</li> <li>The motor terminal voltage is too low. Check the setting of the base frequency voltage parameter (<math>\mu L \mu</math>). (Refer to section 5.11)</li> <li>Replace the cable with a cable larger in diameter.</li> <li>The reduction gear ratio, etc., are not set properly. Adjust the reduction gear ratio, etc.</li> <li>The output frequency is not set correctly. Check the output frequency range.</li> <li>Adjust the base frequency. (Refer to section 5.11)</li> </ul>
<p>The motor speed fluctuates during operation.</p>	<ul style="list-style-type: none"> <li>The load is too heavy or too light. Reduce the load fluctuation.</li> <li>The inverter or motor used does not have a rating large enough to drive the load. Use an inverter or motor with a rating large enough.</li> <li>Check whether the frequency setting signal changes.</li> <li>If the V/F control selection parameter <math>Pf</math> is set at 3, check the vector control setting, operation conditions, etc. (Refer to section 5.12)</li> </ul>
<p>Parameter settings cannot be changed.</p>	<ul style="list-style-type: none"> <li>Change the setting of the parameter setting selection prohibited parameter <math>F700</math> to 0 (enabled) if it is set to 1 to 4 (prohibited).</li> <li>Set the verification code to <math>F739</math>, if password has entered by the password setting <math>F73B</math>. (Refer to section 6.29.1)</li> <li>Switch off the logic input terminal, if this terminal is assigned to input terminal menu 200 to 203 (Parameter editing / reading prohibition).</li> <li>For reasons of safety, some parameters cannot be reprogrammed while the inverter is running. (Refer to section 4.2)</li> </ul>

#### How to cope with parameter setting-related problems

<p>If you forget parameters which have been reset</p>	<ul style="list-style-type: none"> <li>You can search for all reset parameters and change their settings. * Refer to section 4.3.1 for details.</li> </ul>
<p>If you want to return all reset parameters to their respective default settings</p>	<ul style="list-style-type: none"> <li>You can return all parameters which have been reset to their default settings. * Refer to section 4.3.2 for details.</li> </ul>



Mandatory action

- Before inspection, perform the following steps.
    - (1) Shut off all input power to the inverter.
    - (2) Wait at least 15 minutes and check to make sure that the charge lamp is no longer lit.
    - (3) Use a tester that can measure DC voltages (400V/800V DC or more), and check that the voltage to the DC main circuits (across PA/+ - PC/-) does not exceed 45V.
- Performing an inspection without carrying out these steps first could lead to electric shock.

Be sure to inspect the inverter regularly and periodically to prevent it from breaking down because of the environment of use, such as temperature, humidity, dust and vibration, or deterioration of its components with aging.

## 14.1 Regular inspection

Since electronic parts are susceptible to heat, install the inverter in a cool, well-ventilated and dust-free place. This is essential for increasing the service life.

The purpose of regular inspections is to maintain the correct environment of use and to find any sign of failure or malfunction by comparing current operation data with past operation records.

Subject of inspection	Inspection procedure			Criteria for judgment
	Inspection item	Inspection cycle	Inspection method	
1. Indoor environment	1)Dust, temperature and gas 2)Drop of water or other liquid 3)Room temperature	Occasionally  Occasionally  Occasionally	1)Visual check, check by means of a thermometer, smell check 2)Visual check 3)Check by means of a thermometer	1)Improve the environment if it is found to be unfavorable. 2)Check for any trace of water condensation. 3)Max. temperature: 60°C
2. Units and components	1)Vibration and noise	Occasionally	Tactile check of the cabinet	If something unusual is found, open the door and check the transformer, reactors, contactors, relays, cooling fan, etc., inside. If necessary, stop the operation.
3. Operation data (output side)	1)Load current 2)Voltage (*) 3) Temperature	Occasionally  Occasionally  Occasionally	Moving-iron type AC ammeter Rectifier type AC voltmeter Thermometer	To be within the rated current, voltage and temperature. No significant difference from data collected in a normal state.

\*) The voltage measured may slightly vary from voltmeter to voltmeter. When measuring the voltage, always take readings from the same circuit tester or voltmeter.

## ■ Cautions about cleaning



To clean the inverter, wipe dirt off only its surface with a soft cloth but do not try to remove dirt or stains from any other part. If stubborn stains persist, remove them by wiping gently with a cloth dampened with neutral detergent or ethanol.

Never use any of the chemicals in the table below; the use of any of them may damage or peel the coating away from molded parts (such as plastic covers and units) of the inverter.

Acetone	Ethylene chloride	Tetrachloroethane
Benzen	Ethyl acetate	Trichloroethylene
Chloroform	Glycerin	Xylene

## 14.2 Periodical inspection

Make a periodical inspection at intervals of 3 to 6 months depending on the operating conditions.

 <b>Warning</b>	
 Mandatory action	<ul style="list-style-type: none"><li>• Before inspection, perform the following steps.<ol style="list-style-type: none"><li>(1) Shut off all input power to the inverter.</li><li>(2) Wait at least 15 minutes and check to make sure that the charge lamp is no longer lit.</li><li>(3) Use a tester that can measure DC voltages (400V/800V DC or more), and check that the voltage to the DC main circuits (across PA/+ - PC/-) does not exceed 45V.</li></ol></li></ul> <p><b>Performing an inspection without carrying out these steps first could lead to electric shock.</b></p>
 Prohibited	<ul style="list-style-type: none"><li>• Do not replace parts. This could be a cause of electric shock, fire and bodily injury. To replace parts, call your Toshiba distributor.</li></ul>

14

5. If no power is supplied to the inverter for a long time, the performance of its large-capacity electrolytic capacitor declines. When leaving the inverter unused for a long time, supply it with electricity once every two years, for 5 hours or more each, to recover the performance of the large-capacity electrolytic capacitor. And also check the function of the inverter. It is advisable not to supply the commercial power directly to the inverter but to gradually increase the power supply voltage with a transformer, etc.
6. If the need arises, conduct an insulation resistance test on the main circuit terminal block only, using a 500V insulation resistance tester. Never conduct an insulation resistance test on control terminals other than terminals on the printed circuit board or on control terminals. When testing the motor for insulation resistance, separate it from the inverter in advance by disconnecting the cables from the inverter output terminals U/T1, V/T2 and W/T3. When conducting an insulation resistance test on peripheral circuits other than the motor circuit, disconnect all cables from the inverter so that no voltage is applied to the inverter during the test.  
Standard: Several MΩ or more. (Built-in noise filter cause to detect low insulation resistance.)

(Note) Before an insulation resistance test, always disconnect all cables from the main circuit terminal block and test the inverter separately from other equipment..

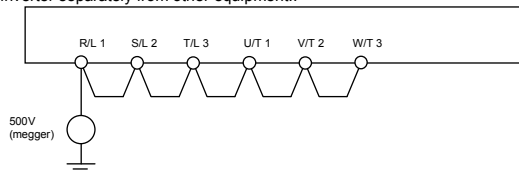

7. Never test the inverter for dielectric strength. A dielectric test may cause damage to its components.
8. Voltage and temperature check

Recommended voltmeter : Input side ... Moving-iron type voltmeter (⚡)

Output side ... Rectifier type voltmeter (▶▶)

It will be very helpful for detecting a defect if you always measure and record the ambient temperature before, during and after the operation.

1) Cooling fan

The fan for cooling heat-generating parts has a service life of about ten years. The fan also needs to be replaced if it makes a noise or vibrates abnormally.

2) Smoothing capacitor

The smoothing aluminum electrolytic capacitor in the main circuit DC section degrades in performance because of ripple currents, etc. It becomes necessary to replace the capacitor after it is used for about 10 years under normal conditions. Since the smoothing capacitor is mounted on a printed circuit board, it must be replaced together with the circuit board.

<Criteria for appearance check>

- Absence of liquid leak
- Safety valve in the depressed position
- Measurement of electrostatic capacitance and insulation resistance

Note: Checking the life alarm function is useful for roughly determining the parts replacement time.

To ensure customer safety, you should never replace parts on your own. (It is also possible to monitor the part replacement alarm and output a signal.)

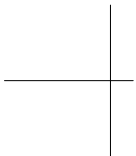

**14**

---

N-4

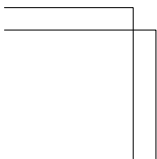

Cooling fan	10 years	Replacement with a new one (To be determined after inspection)
Main circuit aluminum electrolytic capacitor	10 years Note 2	Replacement with a new one (To be determined after inspection)
Relays	-	Whether to replace or not depends on the check results
Aluminum electrolytic capacitor mounted on a printed circuit board	10 years Note 2	Replace with a new circuit board (To be determined after inspection)

Note 1: The replacement cycle is calculated on the assumption that the average ambient temperature over a year is 40°C and operates 24 hours a day. The environment must be free of corrosive gases, oil mist and dust.

Note 2: Figures are for when the inverter output current is 80% of the rated current of the inverter.

Note 3: The life of parts varies greatly depending on the operating environment.

## 14.3 Making a call for servicing

---

If defective conditions are encountered, please contact your Toshiba distributor.

When making a call for servicing, please inform us of the contents of the rating label on the right panel of the inverter, the presence or absence of optional devices, etc., in addition to the details of the failure.

## 14.4 Keeping the inverter in storage

---

Take the following precautions when keeping the inverter in storage temporarily or for a long period of time.

1. Store the inverter in a well-ventilated place away from heat, damp, dust and metal powder.
2. If no power is supplied to the inverter for a long time, the performance of its large-capacity electrolytic capacitor declines.

When leaving the inverter unused for a long time, supply it with electricity once every two years, for 5 hours or more each, to recover the performance of the large-capacity electrolytic capacitor. And also check the function of the inverter. It is advisable not to supply the commercial power directly to the inverter but to gradually increase the power supply voltage with a transformer, etc.

3. For the following kinds of failure or damage, the repair cost shall be borne by the customer even within the warranty period.
- Failure or damage caused by improper or incorrect use or handling, or unauthorized repair or modification of the inverter
  - Failure or damage caused by the inverter falling or an accident during transportation after the purchase
  - Failure or damage caused by fire, salty water or wind, corrosive gas, earthquake, storm or flood, lightning, abnormal voltage supply, or other natural disasters
  - Failure or damage caused by the use of the inverter for any purpose or application other than the intended one
4. All expenses incurred by Toshiba for on-site services shall be charged to the customer, unless a service contract is signed beforehand between the customer and Toshiba, in which case the service contract has priority over this warranty.

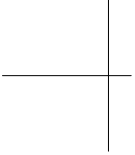

---

O-1

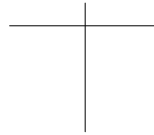
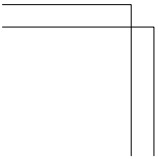

For safety's sake, do not dispose of the disused inverter yourself but ask an industrial waste disposal agent.  
Disposing of the inverter improperly could cause its capacitor to explode and emit toxic gas, causing injury to persons.

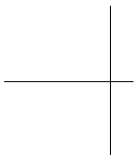

---

P-1

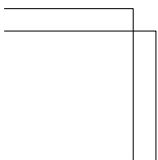

# TOSHIBA

## TOSHIBA INDUSTRIAL PRODUCTS SALES CORPORATION

Global Industrial Products Business Unit  
9-11, Nihonbashi-Honcho 4-Chome,  
Chuo-ku, Tokyo, 103-0023, Japan  
TEL : +81-(0)3-3457-8128  
FAX : +81-(0)3-5444-9252

**TOSHIBA INTERNATIONAL CORPORATION**  
13131 West Little York RD., Houston,  
TX 77041, U.S.A  
TEL : +1-713-466-0277  
FAX : +1-713-466-8773

**TOSHIBA INFRASTRUCTURE SYSTEMS  
SOUTH AMERICA LTD**  
Av. Ibirapuera 2.332, Torre I, 5th floor  
Moema, 04028-003, Sao Paulo-SP, Brazil  
TEL : +55-(0)11-4083-7900  
FAX : +55-(0)11-4083-7910

**TOSHIBA ASIA PACIFIC PTE., LTD**  
152 Beach Rd., #16-00 Gateway East,  
Singapore 189721  
TEL : +65-6297-0990  
FAX : +65-6297-5510

**TOSHIBA CHINA CO., LTD**  
HSBC Tower, 1000 Lujiazui Ring Road,  
Pudong New Area, Shanghai  
200120, The People's Republic of China  
TEL : +86-(0)21-6841-5666  
FAX : +86-(0)21-6841-1161

**TOSHIBA INTERNATIONAL CORPORATION PTY., LTD**  
2 Morton Street Parramatta, NSW2150, Australia  
TEL : +61-(0)2-9768-6600  
FAX : +61-(0)2-9890-7542

**TOSHIBA CIS LIMITED LIABILITY COMPANY**  
Kievskaya st., entrance 7, floor 12  
Moscow, 121059, Russian Federation  
TEL : +7-(0)495-642-8929  
FAX : +7-(0)495-642-8908

**TOSHIBA INDIA PRIVATE LIMITED**  
3rd Floor, Building No.10, Tower B,  
Phase-II, DLF Cyber City, Gurgaon-122002 India  
TEL : +91-(0)124-4996600  
FAX : +91-(0)124-4996623

**TOSHIBA INFORMATION, INDUSTRIAL AND POWER  
SYSTEMS TAIWAN CORP.**  
6F, No66, Sec1 Shih Sheng N.RD, Taipei, Taiwan  
TEL : +886-(0)2-2581-3639  
FAX : +886-(0)2-2581-3631

- For further information, please contact your nearest Toshiba Representative or Global Industrial Products Business Unit-Producer Goods.
- The data given in this manual are subject to change without notice.



## X-ON Electronics

Largest Supplier of Electrical and Electronic Components

*Click to view similar products for [Motor Drives](#) category:*

*Click to view products by [Toshiba](#) manufacturer:*

Other Similar products are found below :

[GMA02](#) [1300920283](#) [GMA11](#) [GMA20](#) [R88DUA03LAAC100V30W](#) [R88DUA12HA](#) [R88DUP03LAAC100V30W](#) [STR2](#) [MFMCB0030GET](#)  
[1302263150](#) [1300920078](#) [R88D-GT04H](#) [R88D-GN04H-ML2](#) [R7D-BP01H](#) [R88D-KN04L-ECT](#) [70354063](#) [79294435](#) [27358015](#) [15275008](#)  
[STAC6-QE](#) [1SFA896112R1100](#) [GNCF8-11](#) [KLC35BE](#) [ST10-Q-RN](#) [1302263161](#) [VX5A1300](#) [2SIE 71-2A](#) [2SIE 71X-4C](#) [DV0P4140-FTDI](#)  
[R88A-CA1C005SF-E](#) [R88A-CR1B005NF-E](#) [SEH 56-2C](#) [SEHR90-4L](#) [U-PKZ0\(400V50HZ\)](#) [LUCC12BL](#) [LUCC12FU](#) [LU9BN11L](#) [LULC08](#)  
[319.3860.20.00](#) [319.3860.30.00](#) [319.3862.20.00](#) [3AUA0000038701](#) [3AUA0000038843](#) [3AUA0000039630](#) [3AUA0000058186](#) [68878365](#)  
[68878373](#) [3G3MX2-AB002-E-ECT](#) [111.3763.30.00](#) [111.9039.20.00](#)