

Innovative and Powerful Features!

- ◆ Rugged metal case for harsh industrial environments
- ◆ Shock and vibration proof
- ◆ Worldwide Safety approval package.
- ◆ ATEX certification tested in accordance to IECEX (opt. EX)
- ◆ Model TSP 090-124N meets NEC class 2
- ◆ Industrial operating temperature range: -25°C to +70°C
- ◆ Adjustable output voltage
- ◆ Protection against short-circuit, overvoltage and over-temperature
- ◆ Power OK signal, Remote On/Off
- ◆ Wall mounting (opt.)
- ◆ 3-year product warranty



The TSP series comprises high performance DIN-rail mount power supplies designed for reliable operation under difficult factory floor conditions. High immunity against electrical disturbances and rugged metal casing make these modules the best choice to power sensitive loads in industrial process control systems, machine tools or other demanding industrial applications. They provide a DC-OK signal and external shut down function. Detachable screw terminal blocks make the connection easy.

Function Modules (see page 5)



This power supply line is accompanied by a wide range of function modules for reliable system solutions:

Redundancy modules for true current sharing in parallel operation and for redundant systems.

Battery controller modules to configure high reliable UPS systems for 12, 24 and 48 VDC. Selection of battery packs available.

Buffer modules for protection against short time AC power loss. Maintenance free! No batteries required.

Models

Order Code	Output Power (Pmax)	**Output Voltage (Vnom)	***Output Current (Imax)
TSP 070-112*	72 W	12 VDC	6.0 A
TSP 090-124*	90 W	24 VDC	3.75 A
TSP 090-124N	90 W	24 VDC	3.75 A
TSP 090-148*	96 W	48 VDC	2.0 A
TSP 140-112*	144 W	12 VDC	12.0 A
TSP 180-124*	180 W	24 VDC	7.5 A
TSP 180-148*	192 W	48 VDC	4.0 A
TSP 360-124*	360 W	24 VDC	15.0 A
TSP 360-148*		48 VDC	7.5 A
TSP 600-124*	600 W	24 VDC	25.0 A
TSP 600-136		36 VDC	16.5 A
TSP 600-148*		48 VDC	12.5 A

* For ATEX compliant models add appendix -EX to order code.

** Output voltage adjustable 12-14 VDC, 24-28 VDC and 48-56VDC

*** Max. current at nominal output voltage and operating temperature up to +40°C max.

Input Specifications

Input voltage range	TSP 070/090 other models: output current derating at operation below 100 VAC	85 – 264 VAC universal input 85 – 132 / 187 – 264 VAC autoselect see graph B, page 4
Input voltage frequency		47 – 63 Hz
Harmonic limits		EN 61000-3-2, Class A (for limited output power)
Holdup time	230 VAC 115 VAC	20 ms 10 ms at full load, 20 ms at 66% load
Inrush current	TSP 070/090 TSP 140/180 TSP 360 TSP 600	115 VAC 230 VAC < 12 A < 13 A < 16 A < 25 A < 20 A < 25 A < 25 A < 30 A
Recommended circuit breaker, characteristic B	TSP 070/090/140/180 TSP 360 TSP 600	6.0 – 16.0 A 10.0 – 16.0 A 16.0 – 25.0 A
Efficiency		87 % typ.

Output Specifications

Output voltage adj. range	12 VDC models: 24 VDC models: 36 VDC model: 48 VDC models:	12 – 14 VDC 24 – 28 VDC 36 – 42 VDC 48 – 56 VDC	At output voltage higher than nominal output voltage max. output current has to be reduced accordingly, in order not to exceed max. output power.
Regulation	– Input variation – Load variation (10–100 %)	0.5 % max. 0.5 % max.	
Ripple and Noise (20MHz bandwidth)		100 mV pk-pk typ. (200 mV pk-pk max. at I _{max})	
Electronic short circuit protection		current limitation at I _{max} . constant current, automatic recovery	
Output overvoltage protection	12 VDC models: 24 VDC models: 36 VDC model: 48 VDC models:	20 V 35 V 43 V 60 V	
Overload protection		electronic overload protection	
Overtemperature protection		switch off at overtemperature, automatic restart	
Power back immunity	12 VDC models: 24 VDC models: 36 VDC model: 48 VDC models:	16 V 35 V 48 V 63 V	
Status indicator		dual color LED (green: DC ok, red: DC off)	
Power OK signal	– trigger threshold: – active output signal: (reference to –V _{out}) – relay output	12 VDC models: 9 – 11 V 24 VDC models: 18 – 22 V 36 VDC model: 27 – 34 V 48 VDC models: 36 – 46 V 12 VDC models: 11.0 V ±1.0 V (20 mA max. for TSP 070, 40 mA max. for TSP 140) 24 VDC models: 22.0 V ±2.0V / 20 mA max. (10 mA max. for TSP 090, 20mA max. for others) 36 VDC model: 34.0 V ±2.0 V / 20 mA max. 48 VDC models: 44.0 V ±4.0 V / 15 mA max.	DC OK = contact closed rated: 30 VDC/1.0 A for 12/24 VDC models rated: 30 VDC/2.0 A for 36 VDC model rated: 48 VDC/0.5 A for 48 VDC models

General Specifications

Max. capacitive load		unlimited
Temperature range	– Operating	–25°C to +60°C max. (with derating) (for derating see graph A on page 4)
	– Storage	–25°C to +85°C
Cooling		convection cooling, no internal fan
Humidity (non condensing)		95 % rel. H max.
Pollution degree		2
Altitude during operation		2'000 m max.
Temperature coefficient		0.02 %/K
Reliability, calculated MTBF (at +25°C acc. to IEC 61709)	– TSP 070/090	>1.8 Mio h
	– TSP 140	>1.2 Mio h
	– TSP 180/360/600	>0.9 Mio h
Remote On/Off		by ext. contact. DC on: -S contact open DC off: -S connected via 1Kohm to -Vout
Isolation (60 s)	– Input to output	3'000 VAC
	– Input to PE	1'500 VAC
	– Output to PE	500 VAC
Safety standards	– Information technology equipment	IEC/EN 60950-1, UL 60950-1, CSA-C22.2 No. 60950-1-03
	– Measurement, Control & Laboratory	IEC/EN 61010-1, IEC/EN 61010-2-201
	– Industrial control equipment	UL 508, CSA-C22.2 No. 107
	– Electrical equipment for machines	EN 60204
	– Electronic equipment for power installation	EN 50178
	– Safety transformers for SMPS	EN 61558-2-16
	– Limited power source (model TSP 090-124N)	EN 60950 sect. 2.5 and NEC Class 2
	– Control equipment for hazardous location	UL 60079-15 (Class I, Division 2, Groups A,B,C,D AEx n C II C T4 U)
		IEC/EN 60079-15 (Class I, Zone 2, EEx nC II C T4 U), ⚠ II3G EEx nAC IIC T4 (T3 with limited power)
Safety approvals and certifications	– CB report	for IEC/EN 60950-1, IEC/EN 61010-1 & 61010-2-201
	– UL approvals	UL 60950-1 rec. File: e181381, UL 508 listed File: e210002
	– CSA certification	(file no. 219759) for UL 60950-1, UL 508, UL 60079-15-02, ANSI/ISA 12.12.01, CSA-22.2 No. 60950-1-03, CSA C22.2 No. 107, CSA 60079-15-02
	– ⚠ II3G ATEX 94/9/EC	certificate no. EPS 12 ATEX 1 424 X (option -EX only)
	– BG certification	EN 60950-1, EN 60204-1, EN 61558-2-16, EN 50178
	– Certification documents	www.tracopower.com/overview/tsp
Class of protection		safety class I (IEC 536)
Degree of protection		IP 20 (IEC/EN 60529)
Electromagnetic compatibility (EMC), Emissions	– Conducted RI suppression on input	EN 61000-6-3, EN 61204-3
	– Radiated RI suppression	EN 55011 class B, EN 55022 class B, EN 55011 class B, EN 55022 class B,
Electromagnetic compatibility (EMC), Immunity	– Electrostatic discharge (ESD)	EN 61000-6-2, EN 61204-3
	– Radiated RF field immunity	IEC / EN 61000-4-2 4 kV / 8 kV criteria B
	TSP 070/140/360 models:	IEC / EN 61000-4-3 10 V / m criteria A
	TSP 090/180/600 models:	IEC / EN 61000-4-3 10 V / m criteria B
	– Electrical fast transient / burst immunity	IEC / EN 61000-4-4 2 kV criteria B
	– Surge immunity	IEC / EN 61000-4-5 1 kV / 2 kV criteria B
	– Immunity to conducted RF disturbances	IEC / EN 61000-4-6 10 V criteria A
	– Power frequency field immunity	IEC / EN 61000-4-8 30 A / m criteria A
	– Mains voltage dips and interruptions	IEC / EN 61000-4-11 criteria B/C
	– Voltage sag immunity	SEMI F47
		www.tracopower.com/overview/tsp

General Specifications

Environment	– Vibration acc. IEC 60068-2-6; – Shock acc. IEC 60068-2-27	3 axis, sine sweep, 10 – 55 Hz, 1 g, 1 oct/min 3 axis, 15 g half sine, 11 ms
Enclosure material		aluminium (chassis) / stainless steel (cover)
Mounting	– DIN-rail mounting – Wall mounting (option)	for DIN-rails as per EN 50022-35x15/7.5 (snap-on with self-locking spring) with wall mounting bracket - see page 9
Connection		detachable screw terminals (plugs included) 2 terminals per output
Remote On/Off connection	– 2 pin molex male terminal KK series	mating connector information (cable not included) www.tracopower.com/products/tsp-jc.pdf
Installation instructions		www.tracopower.com/overview/tsp

Output Power Derating

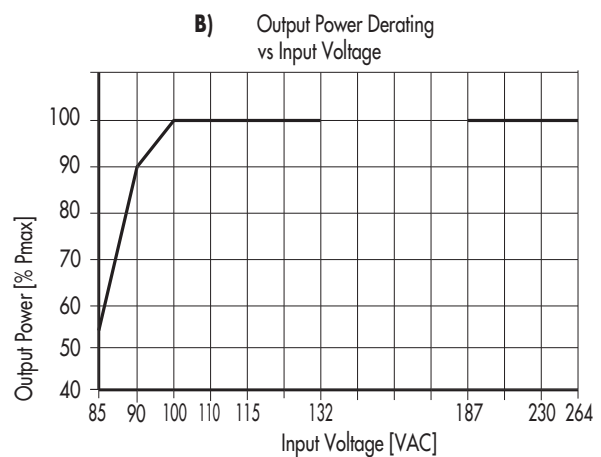
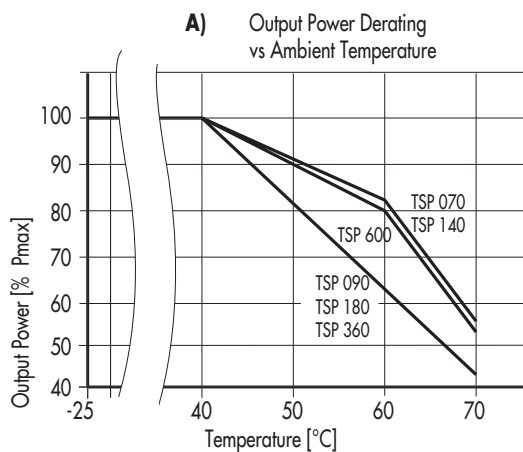

All specifications valid at nominal input voltage, full load and +25°C after warm-up time unless otherwise stated.

Function Modules Overview

Redundancy Module:

With this module and two power supplies of the TSP series a highly reliable, true redundant power system can be configured without any additional components. This module provides:

- Operation with true current sharing
- Alarm outputs and redundancy OK signal
- Hot swappable inputs can be loaded up to 1.5A each (resp. 2.5A with model TSP-REM600)



TSP-REM360
TSP-REM600

Models		
Order Code	Output Voltage adj.	Output Power
TSP-REM360	24 VDC	360 W
TSP-REM600	(24 – 27 VDC)	600 W

TSP-REM datasheet: www.tracopower.com/products/tsp-rem.pdf

Battery Controller Modules + Batteries:

This module provides a professional battery controller to charge and monitor an external lead-acid battery. Together with a power supply of the TSP series and a battery pack a perfect DC-UPS system can be configured. This module provides:

- Battery protection for over voltage, deep discharge, short circuit and reverse connection
- Remote On/Off for battery and power supply
- Alarm outputs for input, output and battery condition
- Controlled end of charge voltage by temperature sensor
- Redundant inputs for two independent sources (**TSP-BCM360 only**)



TSP-BCM24A
TSP-BCM48A



TSP-BCM12
TSP-BCM24
TSP-BCM48



TSP-BCM360

Models		
Order Code	Output Voltage	Output Power
TSP-BCM12	12 VDC	180 W
TSP-BCM24	24 VDC	360 W
TSP-BCM24A		600 W
TSP-BCM48	48 VDC	360 W
TSP-BCM48A		600 W
TSP-BCM360	24/48 VDC	360 W

TSP-BCM datasheet: www.tracopower.com/products/tsp-bcm.pdf

TSP-BCM360 datasheet: www.tracopower.com/products/tsp-bcm360.pdf

Buffer Module:

This module will maintain the output voltage of a 24VDC power supply during typical mains faults, short time blackouts or voltage dips of up to ten full 50Hz cycles. During this buffer period no deterioration of the 24VDC output voltage will occur. This module provides:

- Capacitor bank for energy storage, no battery needed!
- Maintenance free, long lifetime, high performance also at low temperature.
- Guaranteed Hold-up-time 200ms/25A to 4s/1.2A max.
- Output 24 to 28VDC, 600W max.
- Active ready and inhibit signals



TSP-BFM24

Models		
Order Code	Output Voltage	Output Power
TSP-BFM24	24 – 28VDC	600 W

TSP-BFM datasheet: www.tracopower.com/products/tsp-bfm.pdf

Outline Dimensions

Models:
TSP 070/090

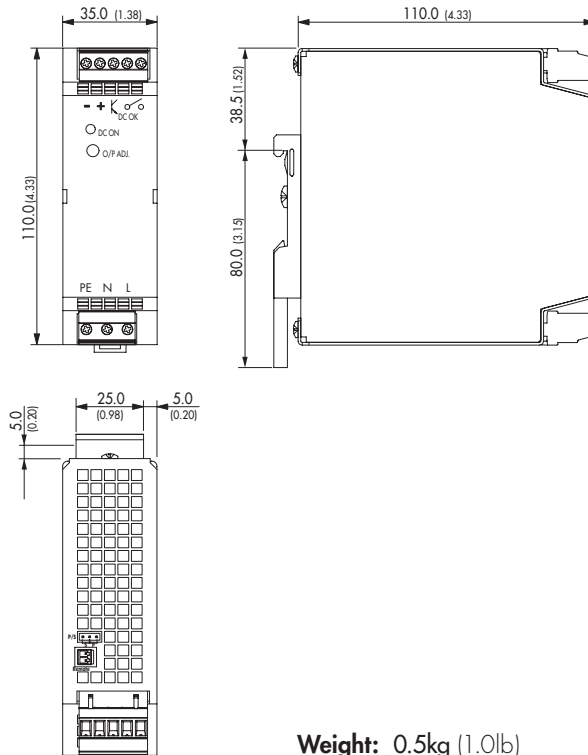

Models:
TSP 140/180

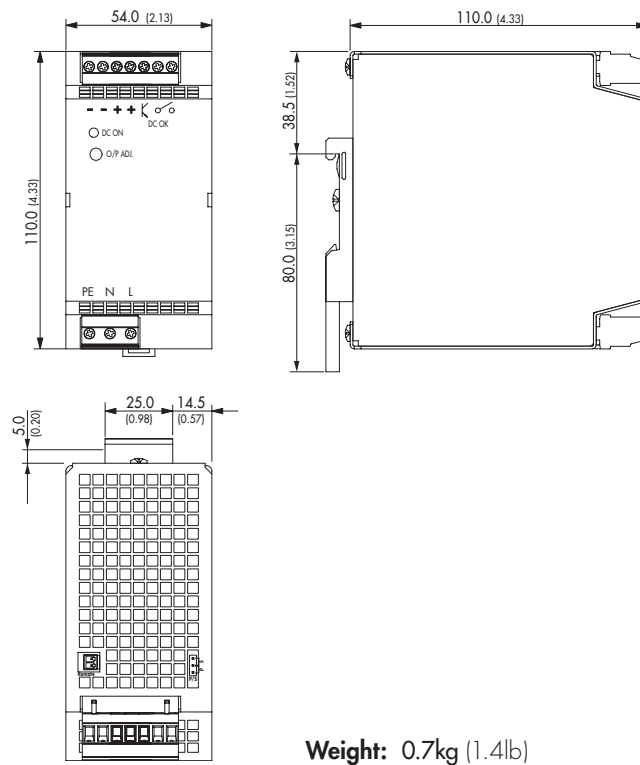

Dimensions in [mm], () = inch
Tolerances: ± 0.5 mm (± 0.02)

Outline Dimensions

Models:
TSP 360

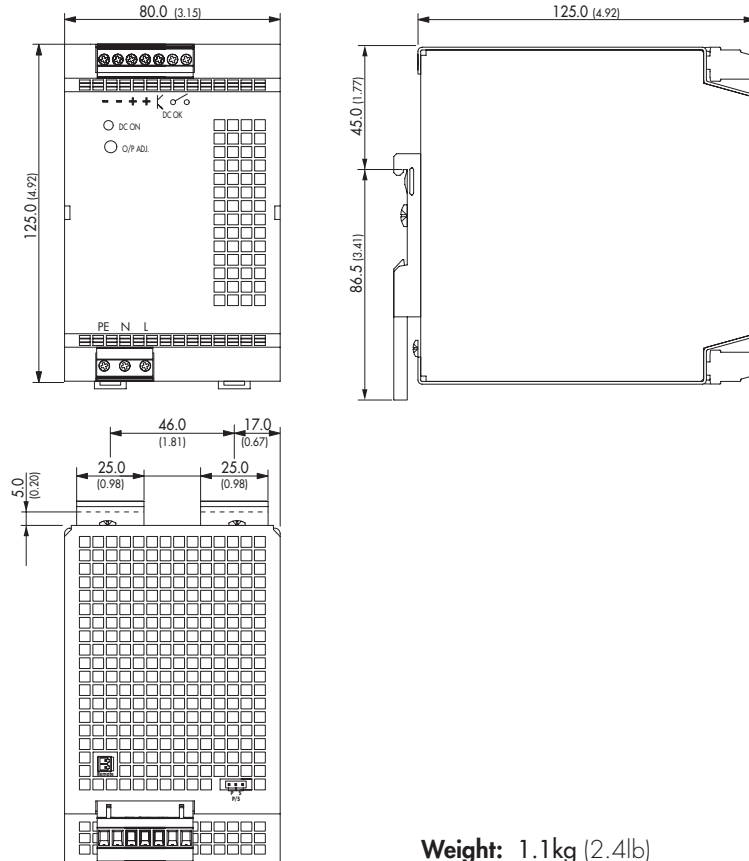

Weight: 1.1kg (2.4lb)

Dimensions in [mm], () = inch
Tolerances: ± 0.5 mm (± 0.02)

Outline Dimensions

Models:
TSP 600

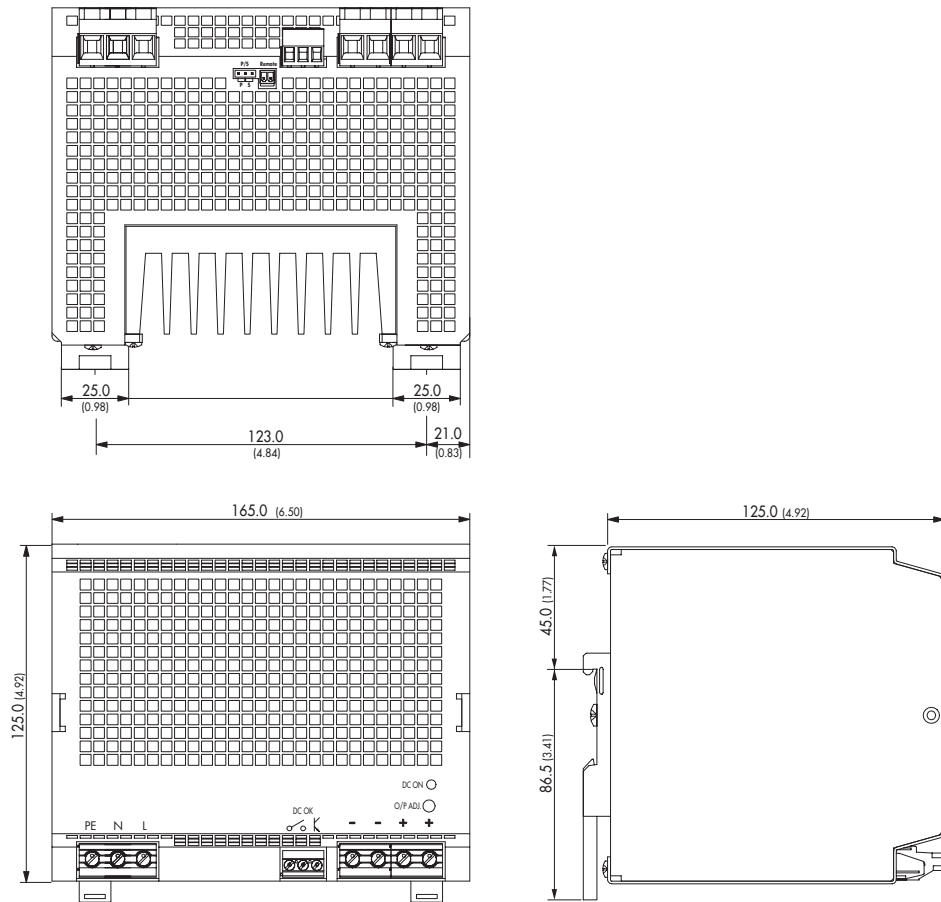

Weight: 2.8kg (6.0lb)

Dimensions in [mm], () = inch
Tolerances: ± 0.5 mm (± 0.02)

TSP-WMK Wall Mounting Bracket

Ordercode of Kit	For Models	Content of Kit
TSP-WMK03	TSP 070, TSP 090, TSP 140, TSP 180	1 bracket
TSP-WMK02	TSP 360, TSP 600	2 brackets

TSP-WMK03

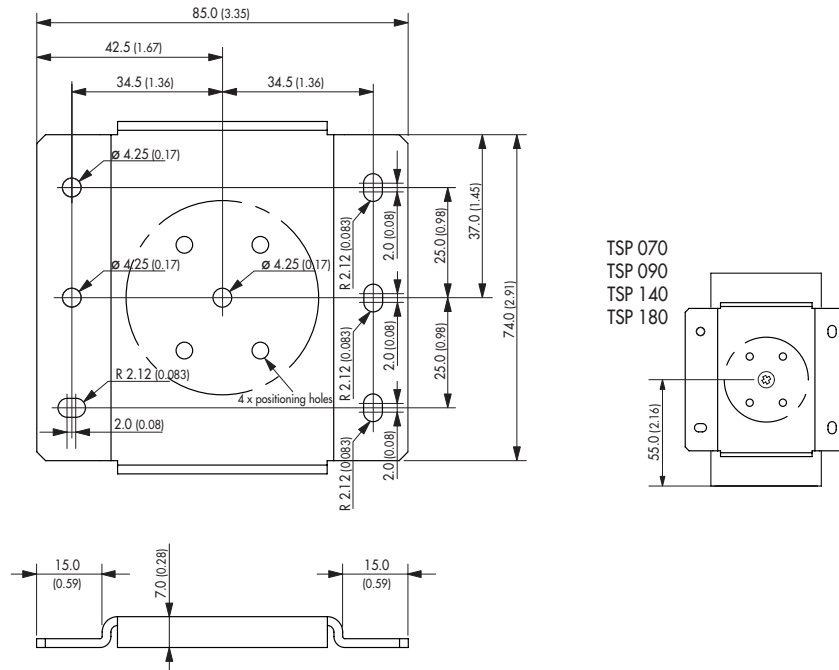

Material: 2 mm Mild Steel
Tolerance: ±0.1 mm (± 0.004)

TSP-WMK02

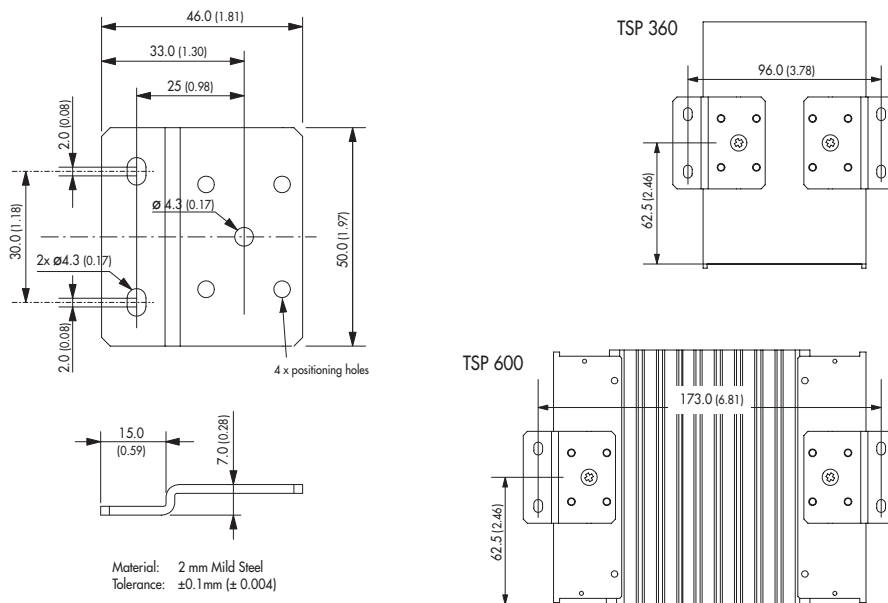

Material: 2 mm Mild Steel
Tolerance: ±0.1 mm (± 0.004)

Dimensions in [mm], () = Inch
Tolerances: ±0.5 mm (±0.02)

Specifications can be changed without notice! Make sure you are using the latest documentation, downloadable at www.tracopower.com

X-ON Electronics

Largest Supplier of Electrical and Electronic Components

Click to view similar products for [DIN Rail Power Supplies](#) category:

Click to view products by [TRACO Power](#) manufacturer:

Other Similar products are found below :

[PS-S6024](#) [DVP01PU-S](#) [DVP06AD-S](#) [DVP06XA-S](#) [DVDPNET-SL](#) [DVPDT01-S](#) [DVPPS01](#) [PS-6012](#) [PS9Z-5R1G](#) [PS-C24024](#)
[DVP08ST11N](#) [DVPACAB530](#) [DVPCOPM-SL](#) [DVPEN01-SL](#) [DVPPF01-S](#) [ADNB008-48-1PM-C](#) [ADNB017-24-1PM-C](#) [ADNB034-12-1PM-C](#) [SS14011524](#) [PS-UPS40](#) [PSC-6024](#) [PSD-A60W12](#) [96PS-A120WDIN](#) [PSD-A60W48](#) [PSD-A40W12](#) [PSD-A40W24](#) [SMP21-L20-DC24V-5A](#) [PSD-A40W48](#) [S8T-DCBU-02](#) [PS-S4024](#) [NTPS-24-1.3](#) [ZI-20](#) [PST-96024](#) [S82YVSC4P](#) [PS-S4005](#) [PS-10024](#) [PS-S10024](#) [PS-C12024](#) [PSP-480S24](#) [PS-C48024](#) [PSC-2024](#) [PSC-4012](#) [PSC-4048](#) [PSC-9615](#) [PSC-15124](#) [PSC-15148](#) [PSC-24148](#) [PSC-48148](#) [TRIO-PS-2G/1AC/12DC/5/C2LP](#) [QUINT4-PS/1AC/12DC/15](#)