

- For global use with single- and two phase wide-range input 100/230–500 VAC
- Rugged metal case for harsh industrial environments
- Industrial operating temperature range: -25°C to $+70^{\circ}\text{C}$
- Power OK signal
- Remote On/Off
- Shock and vibration-proof
- Indefinite short circuit, overvoltage and overtemperature protection
- Redundancy module
- Buffer module for power backup
- Battery controller module
- 3-year product warranty



The successful TSP series of high performance DIN-rail mount power supplies has been expanded with models featuring wide input ranges of 85-132 / 187-264 / 323-550 VAC. With these input ranges the power supplies can be used in almost all single- and multi phase power networks worldwide.

A high, continuously available power reserve guarantees reliable start-up of loads with high inrush currents. Excellent electrical specifications and high immunity against electrical disturbances make these compact power supplies the best choice to power sensitive loads in industrial process control systems, machine tools or any other demanding industrial application. The power supplies comply also with IEC/EN 61204-3, the EMC standard for Industrial environment.

3 add-on modules for extra functions offer a great flexibility in system applications. A module for redundant operation with true power sharing is available. With the battery controller module the power supplies can be extended to a perfect DC-UPS system. The buffer module provides power back-up for up to 4 seconds without the need of any batteries. Easy and vibration proof installation with pluggable screw terminal block and snap-on mounting on DIN-rails.

Models

Order Code	Output Voltage (V _{nom})	*Output Current (I _{max})	Output Power (P _{max})
TSP 180–124WR	24 VDC (adjustable 24 - 28 VDC)	7.5 A	180 W
TSP 360–124WR		15.0 A	360 W
TSP 600–124WR		25.0 A	600 W

* Max. current at nominal output voltage and operating temperature up to 40°C max.

Input Specifications

Applicable 3-phase networks	– TN, TT Systems:	500 VAC Star configuration (EN60950, UL508) 500 VAC Delta (UL508 only)
	– IT Systems:	400 VAC Delta (IEC-62103) 230 VAC Delta (IEC-60950) 500 VAC (UL508)
Input ranges	select (low/high) by manual switch: auto range selection in high ranges: input frequency:	85–132 VAC / 187..550 VAC 187–264 VAC / 323–550 VAC 47–63 Hz
Harmonic limits		EN 61000-3-2, Class A (for limited output power)
Holdup time		20 ms min. (full load 230 – 500 VAC)
Inrush current	TSP 180-124VWR TSP 360-124VWR TSP 600-124VWR	< 23 A < 46 A < 50 A
Efficiency		88 % typ.

Output Specifications

Output voltage adjustable range		24–28 VDC
Regulation	– Input variation – Load variation (10–100 %) – Load variation (10–100 %) parallel mode	0.5 % max. 0.5 % max. 2.0%
Ripple and noise (20MHz bandwidth)		100 mV pk-pk typ. (150 mV pk-pk max. at I _{max})
Electronic short circuit protection		current limitation at 125 % of I _{max} . constant current, automatic recovery
Output overvoltage protection		34 V
Overload protection		electronic overload protection
Overtemperature protection		switch off at overtemperature, automatic restart
Status indicator		dual colour LED (green: DC OK, red: DC off)
Power OK signal	– trigger threshold – relay output	18 – 22 V DC OK = contact closed (rated: 30 VDC/1.0 A)
Max. capacitive load		unlimited

General Specifications

Operating temperature range		–25°C to +70°C max. (for derating see graph A on page 3)
Cooling		convection cooling, no internal fan
Storage temperature		–25°C to +85°C
Humidity (non condensing)		95 % rel. H max.
Pollution degree		2
Temperature coefficient		0.02 %/K
Reliability, calculated MTBF at +25°C acc. to IEC 61709		>350'000 heures in accordance to IEC 61709
Remote On/Off		by ext. contact. DC on: -S contact open DC off: -S connected via 1 Kohm to -Vout
Safety standards	– Information technology equipment – Industrial control equipment – Electrical equipment of machines – Electronic equipment for power installation – Safety transformers for SMPS	IEC/EN 60950-1, UL 60950-1, CSA-C22.2 No. 60950-1-03, CSA-C22.2 No. 1071-01 UL 508 EN 60204 EN 50178 EN 61558-2-16

General Specifications

Safety standards	<ul style="list-style-type: none"> – CB scheme – CSA certificate – GS certificate – SIQ certificate – Certification documents 	IEC 60950-1 UL 60950-1, CSA-22.2 No. 60950-1-03, CSA C22.2 No. 1071-0, UL 508 IEC/EN 60950-1, EN 60204, EN 61558-2-4 IEC/EN 60950-1 www.tracopower.com/overview/tsp-wr
Safety class		Degree of electrical protection I (IEC 536)
Case protection		IP 20 (IEC 529)
Electromagnetic compatibility (EMC), Emissions	<ul style="list-style-type: none"> – Conducted RI suppression on input – Radiated RI suppression 	IEC/EN 61000-6-3, IEC/EN 61204-3 EN 55011 class B, EN 55022 class B, EN 55011 class B, EN 55022 class B,
Electromagnetic compatibility (EMC), Immunity	<ul style="list-style-type: none"> – Electrostatic discharge (ESD) – Radiated RF field immunity – Electrical fast transient / burst immunity – Surge immunity – Immunity to conducted RF disturbances – Power frequency field immunity – Voltage dips 	IEC/EN 61000-6-2, IEC/EN 61204-3 IEC/EN 61000-4-2 4 kV / 8 kV IEC/EN 61000-4-3 10 V / m IEC/EN 61000-4-4 2 kV IEC/EN 61000-4-5 1 kV / 2 kV IEC/EN 61000-4-6 10 V IEC/EN 61000-4-8 30 A / m IEC/EN 61000-4-11
Environment	<ul style="list-style-type: none"> – Vibration acc. IEC 60068-2-6; – Shock acc. IEC 60068-2-27 	3 axis, sine sweep, 10-55 Hz, 1g, 1oct/min 3 axis, 15 g half sine, 11 ms
Enclosure material		aluminium (chassis) / zinc plated steel (cover)
Mounting	<ul style="list-style-type: none"> – DIN-rail mounting – Wall mounting (option) 	for DIN-rails as per EN 50022-35x15/7.5 (snap-on with self-locking spring) with wall mounting bracket - see page 10
Connection		detachable screw terminals (plugs included) 2 terminals per output

Output Power Derating

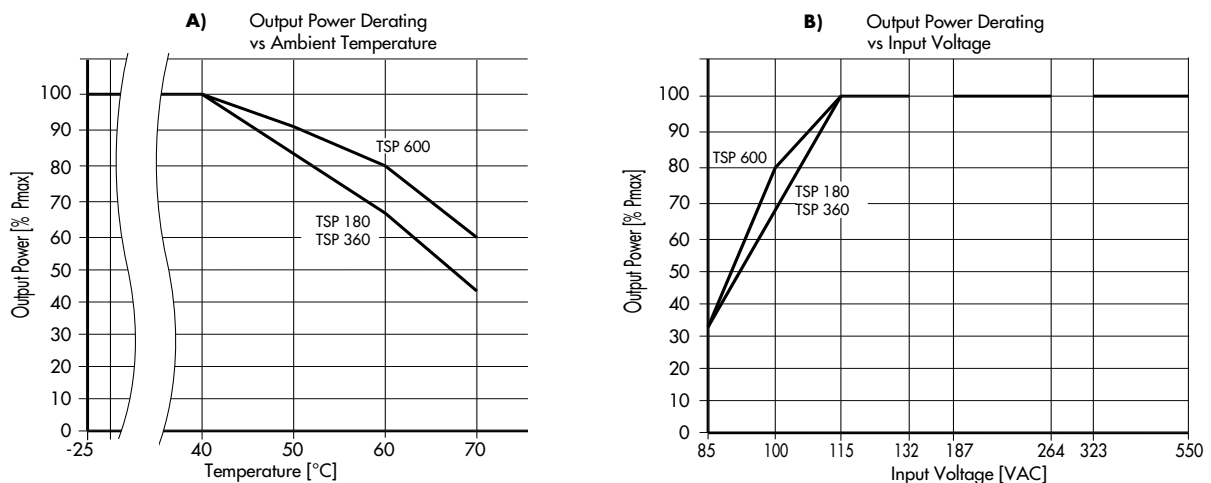

All specifications valid at nominal input voltage, full load and +25°C after warm-up time unless otherwise stated.

Function Modules Overview

Redundancy Module:

With this module and two power supplies of the TSP-(WR) series a highly reliable, true redundant power system can be configured without any additional components. This module provides:

- Operation with true current sharing
- Alarm outputs and redundancy OK signal
- Hot swappable inputs can be loaded up to 1.5A each (resp. 2.5A with model TSP-REM600)

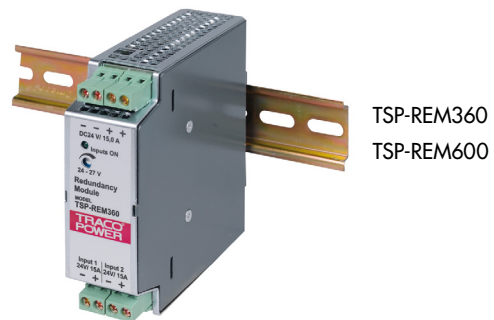

TSP-REM360
TSP-REM600

Models		
Order Code	Output Voltage adj.	Output Power
TSP-REM360	24 VDC	360 W
TSP-REM600	(24 – 27 VDC)	600 W

TSP-REM datasheet: www.tracopower.com/products/tsp-rem.pdf

Battery Controller Modules + Batteries:

This module provides a professional battery controller to charge and monitor an external lead-acid battery. Together with a power supply of the TSP series and a battery pack a perfect DC-UPS system can be configured. This module provides:

- Battery protection for over voltage, deep discharge, short circuit and reverse connection
- Remote On/Off for battery and power supply
- Alarm outputs for input, output and battery condition
- Controlled end of charge voltage by temperature sensor
- Redundant inputs for two independent sources (**TSP-BCM360 only**)

Models		
Order Code	Output Voltage	Output Power
TSP-BCM24	24 VDC	360 W
TSP-BCM24A		600 W

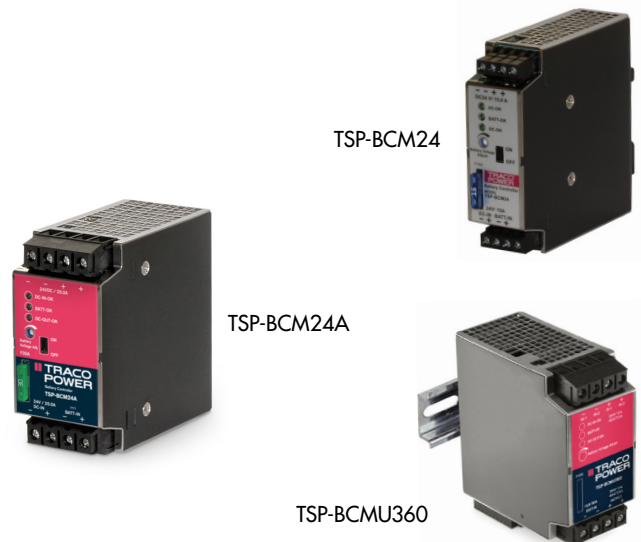

TSP-BCM24

TSP-BCM24A

TSP-BCM360

TSP-BCM datasheet: www.tracopower.com/products/tsp-bcm.pdf

TSP-BCM360 datasheet: www.tracopower.com/products/tsp-bcm360.pdf

Buffer Module:

This module will maintain the output voltage of a 24VDC power supply during typical mains faults, short time blackouts or voltage dips of up to ten full 50Hz cycles. During this buffer period no deterioration of the 24VDC output voltage will occur. This module provides:

- Capacitor bank for energy storage, no battery needed!
- Maintenance free, long lifetime, high performance also at low temperature.
- Guaranteed Hold-up-time 200ms/25A to 4s/1.2A max.
- Output 24 to 28VDC, 600W max.
- Active ready and inhibit signals

Models		
Order Code	Output Voltage	Output Power
TSP-BFM24	24 – 28VDC	600 W



TSP-BFM24

TSP-BFM datasheet: www.tracopower.com/products/tsp-bfm.pdf

Case Dimensions

Models:
TSP-REM360
TSP-BCM24

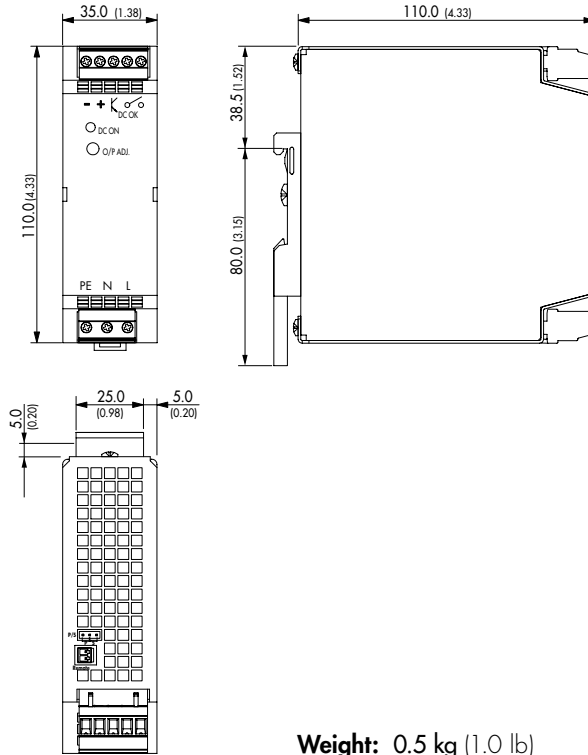

Weight: 0.5 kg (1.0 lb)

Models:
TSP 180-124WR
TSP-REM600
TSP-BCM24A
TSP-BFM24

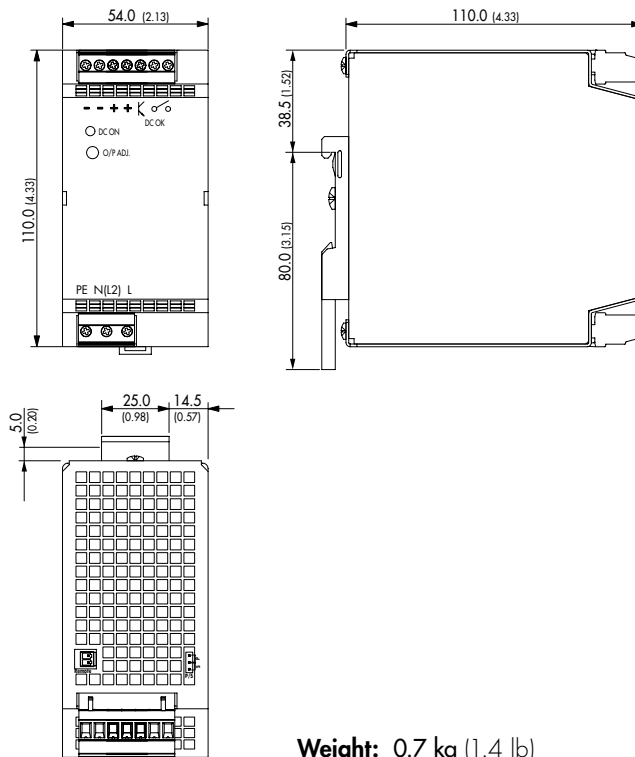

Weight: 0.7 kg (1.4 lb)

Dimensions in [mm], () = inch
 Tolerances: ± 0.5 mm (± 0.02)

Case Dimensions

Model:
TSP 360-124WR

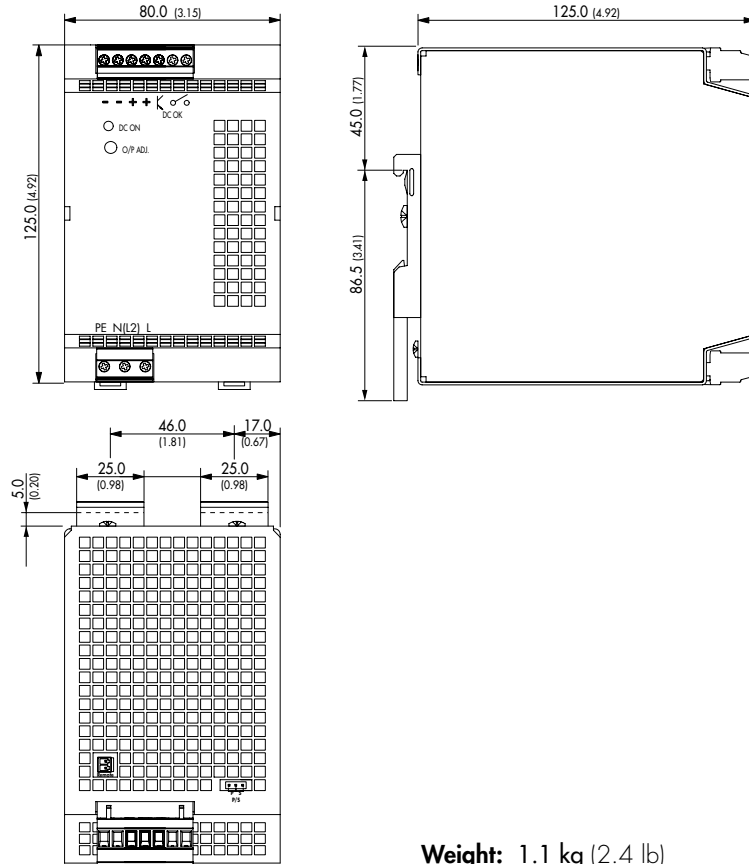

Weight: 1.1 kg (2.4 lb)

Dimensions in [mm], () = inch
Tolerances: ± 0.5 mm (± 0.02)

Case Dimensions

Model:
TSP 600-124WR

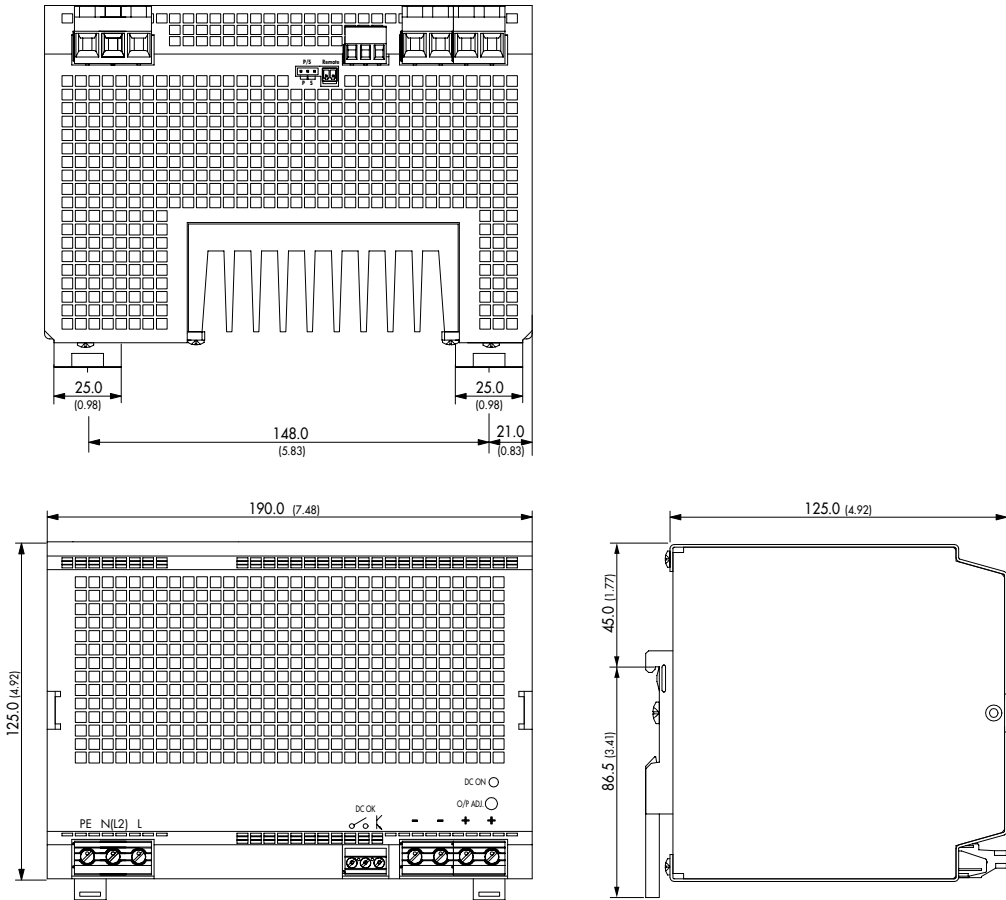

Weight: 3.0 kg (6.0 lb)

Dimensions in [mm], () = inch
Tolerances: ± 0.5 mm (± 0.02)

TSP-WMK Wall Mounting Bracket

Ordercode of kit	For models	Content of kit
TSP-WMK03	TSP 180-124WR, TSP-REM360, TSP-BCM24(A), TSP-BFM	1 bracket
TSP-WMK02	TSP 360-124WR, TSP 600-124WR	2 brackets

TSP-WMK03

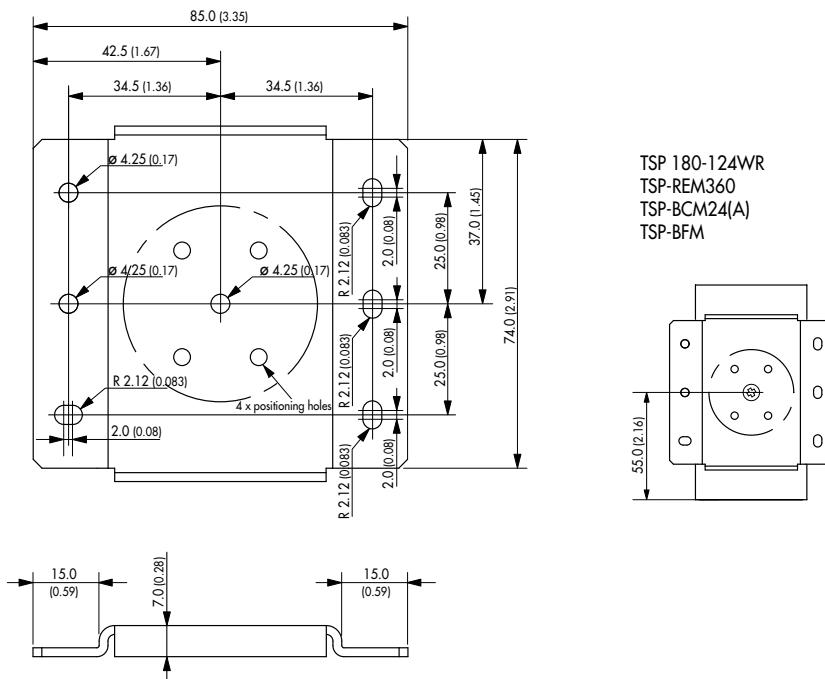

Material: 2 mm Mild Steel
Tolerance: $\pm 0.1\text{mm}$ (± 0.004)

TSP-WMK02

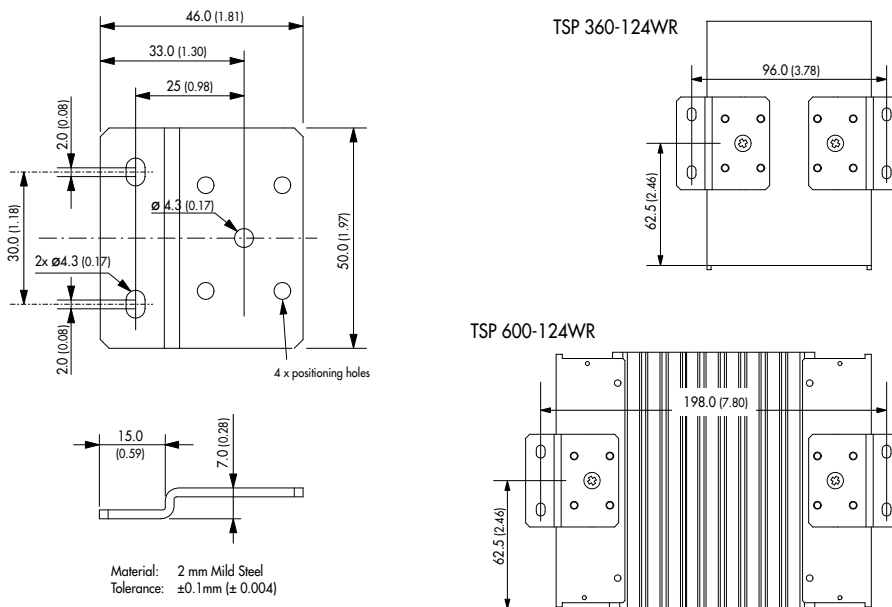

Material: 2 mm Mild Steel
Tolerance: $\pm 0.1\text{mm}$ (± 0.004)

Dimensions in [mm], () = Inch
Tolerances: $\pm 0.5\text{mm}$ (± 0.02)

X-ON Electronics

Largest Supplier of Electrical and Electronic Components

Click to view similar products for [DIN Rail Power Supplies](#) category:

Click to view products by [TRACO Power](#) manufacturer:

Other Similar products are found below :

[PS-3015](#) [PSP-480S48](#) [PSR-SD25](#) [PS-S6024](#) [DRP048V120W1BA](#) [DVP01PU-S](#) [DVP06AD-S](#) [DVP06XA-S](#) [DVDPNET-SL](#) [DVPDT01-S](#)
[DVPPS01](#) [DVPPS02](#) [KHNA30F-5](#) [KHNA60F-24](#) [S8JX-G01524](#) [S8JX-G01548C](#) [S8JX-G03512D](#) [S8VS-09024B-F](#) [PS-6012](#) [PS9Z-5R1G](#)
[PS-C24024](#) [PSC-9648](#) [5607189](#) [KHNA30F-24](#) [KHNA480F-24](#) [KHNA90F-12](#) [KHNA90F-24](#) [DVP08ST11N](#) [DVPACAB530](#) [DVPCOPM-](#)
[SL](#) [DVPEN01-SL](#) [DVPPF01-S](#) [S8JX-G10012](#) [S8JX-G15024](#) [CBI1210A](#) [SS14011524](#) [S8JX-G01505C](#) [S8TS-06024-E1](#) [PS-S2012](#) [PSW-](#)
[12024](#) [PS-UPS40](#) [PSC-6024](#) [S8VS-48024A-F](#) [PSD-A60W12](#) [96PS-A120WDIN](#) [PSD-A60W48](#) [S8JX-G03515CD](#) [PSD-A40W12](#) [PSD-](#)
[A40W24](#) [PSD-A60W24](#)