

### CMF16-153131

**Description:**

The CMF16 Series provides exceptional common-mode suppression and exceptional stray inductance to suppress differential-mode noise. In effect, the CMF16 Series combines the features of two separate components into one.

**Construction:**

Constructed with UL rated 130°C (Class B) materials.

**Electrical Specifications (@20°C) @ 10kHz**

Inductance(1)	L <sub>stray typ</sub>	Amps(2) (A)	Max. DC (Ω) Resistance
15mH	290uH	1.3	0.47

1. Inductance Tolerance: -30/+50%
2. Inductance per winding.
3. Operating Temperature: -40 – 105°C
4. Storage Temperature: -25°C – +40°C, ≤ 75% RH
5. Rated Voltage: 300VAC (50/60Hz)
6. Weight: 9g

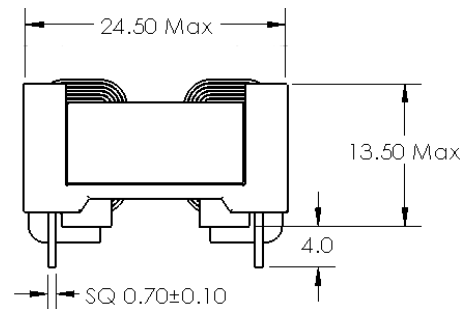

**CMF16 Series – Frequency Response Curve**

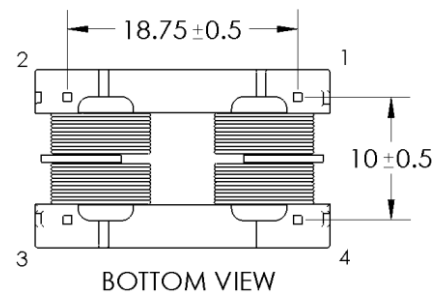
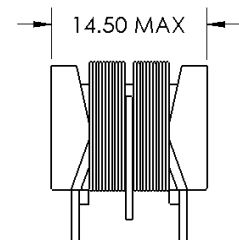
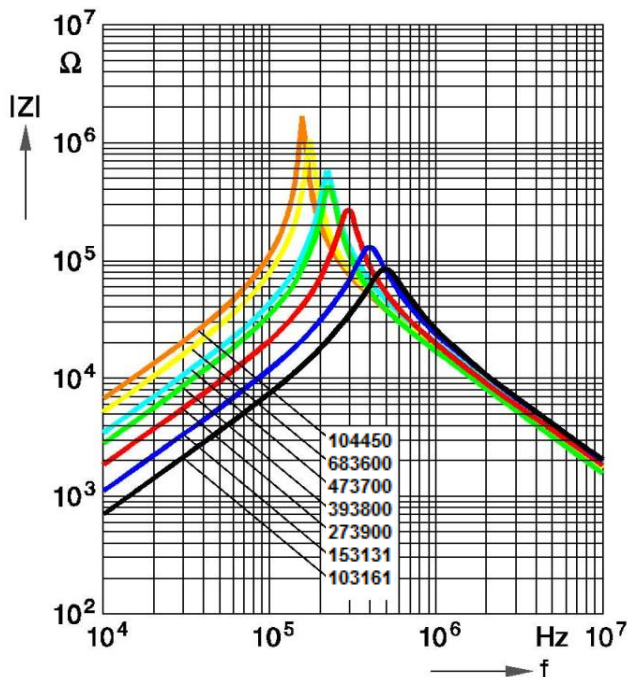

**Safety:** 2000VAC Dielectric Strength between windings.

**RoHS Compliance:** As of manufacturing date February 2016, all standard products meet the requirements of 2015/863/EU, known as the RoHS 3 initiative.

\*Upon printing, this document is considered “uncontrolled”. Please contact Triad Magnetics website for the most current version. For soldering and washing information please see <http://www.triadmagnetics.com>

## X-ON Electronics

Largest Supplier of Electrical and Electronic Components

*Click to view similar products for [Common Mode Chokes / Filters](#) category:*

*Click to view products by [Triad](#) manufacturer:*

Other Similar products are found below :

[RGCMF1210900H3T](#) [B82722A2102N001](#) [UAL21V07012500](#) [UAL24VR06500CH](#) [UALSC0220G0000](#) [UALSC058000000](#)  
[UALSC0580J0000](#) [UALSC1520JH000](#) [UALSU10VR15019](#) [UALSU10VR20010](#) [UALSU16VD30030](#) [UALSU16VD40010](#)  
[UALSU9H0305000](#) [UALSU9HF030600](#) [UALSU9HF060300](#) [UALSU9HR050340](#) [UALSU9VD070100](#) [UALSU9VR070170](#) [5701610000](#)  
[CM7060M132R-10](#) [UALW21HS200290](#) [UALW21HS072450](#) [UALSU9VD070400](#) [UALSU9V0701000](#) [UALSU9HR030900](#)  
[UALSU9HF050500](#) [UALSU9H0701000](#) [UALSU9H0208000](#) [UALSU9H0110000](#) [UALSCF25081300](#) [UALSC0305GS000](#)  
[UALSC0120G0000](#) [UAL24VK06450CH](#) [UAL11VL1105000](#) [RN112-3.6-02-0M4](#) [RN114-1.2-02-10M](#) [RN122-0.6-02-47M](#) [RN122-3-02-4M5](#)  
[RN142-1-02-33M](#) [RN214-2.5-02-3M3](#) [RN112-2-02-1M0](#) [RN143-6-02-1M8](#) [RN214-0.8-02-27M](#) [RN242-1.4-02-27M](#) [EXC-X4CH120X](#)  
[DLW5BTM102TQ2L](#) [CMF16-153131](#) [CMF23H-273141](#) [744252510](#) [B82793C0253N201](#)