

CMF23V-393121

Description:

The CMF23 Series provides exceptional common-mode suppression and exceptional stray inductance to suppress differential-mode noise. In effect, the CMF23 Series combines the features of two separate components into one.

Construction:

Constructed with UL rated 130°C (Class B) materials.

Electrical Specifications (@20°C) @ 10kHz

Inductance(1)	L _{stray typ}	Amps(2) (A)	Max. DC (Ω) Resistance
39mH	800uH	1.2	0.766

1. Inductance Tolerance: -30/+50%
2. Inductance per winding.
3. Operating Temperature: -40 – 105°C
4. Storage Temperature: -25°C – +40°C, ≤ 75% RH
5. Rated Voltage: 300VAC (50/60Hz)
6. Weight: 18g

CMF23 Series – Frequency Response Curve

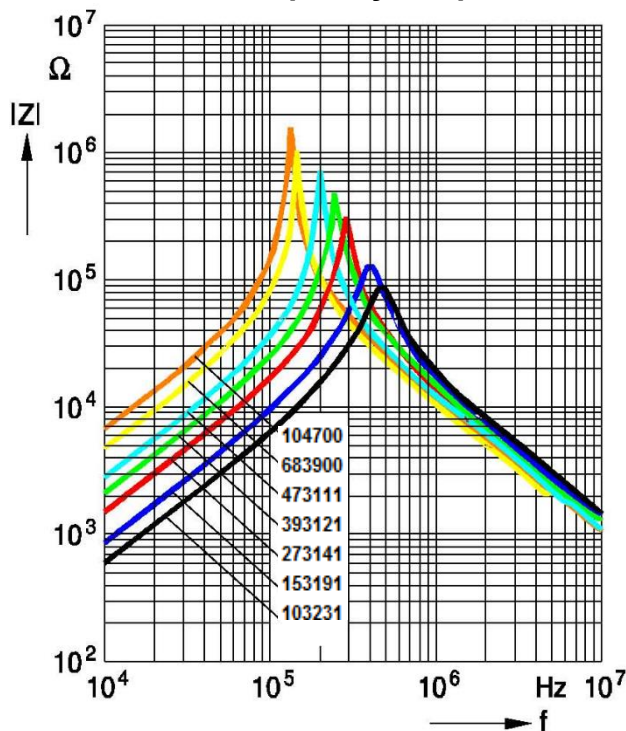

Safety: 2000VAC Dielectric Strength between windings.

RoHS Compliance: As of manufacturing date February 2016, all standard products meet the requirements of 2015/863/EU, known as the RoHS 3 initiative.

*Upon printing, this document is considered "uncontrolled". Please contact Triad Magnetics website for the most current version. For soldering and washing information please see <http://www.triadmagnetics.com>

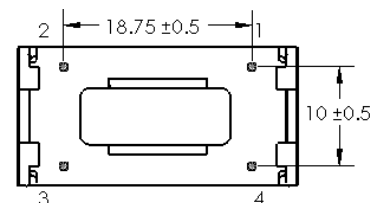
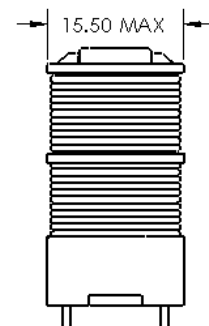
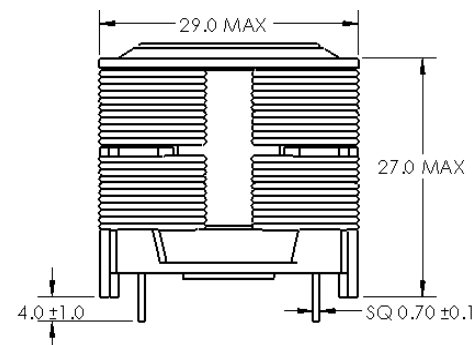

X-ON Electronics

Largest Supplier of Electrical and Electronic Components

Click to view similar products for [Common Mode Chokes / Filters](#) category:

Click to view products by [Triad](#) manufacturer:

Other Similar products are found below :

[74279408](#) [PE-62911NL](#) [PE-64683](#) [ST6118T-R](#) [T8114NLT](#) [RD5122-10-6M0](#) [TCM0806G-350-2P-T](#) [TCM0806G-650-2P-T](#) [IND-0110](#)
[UAL21V07012500](#) [UAL21VR0802000](#) [UAL24VR06500CH](#) [UALSC023000000](#) [UALSC1020JH000](#) [UALSC1520JH000](#)
[UALSU10VR20010](#) [UALSU16VD30030](#) [UALSU16VD40010](#) [UALSU9H0305000](#) [UALSU9HF060300](#) [UALSU9VD070100](#) [36-00037](#)
[5701610000](#) [UALW21HS072450](#) [UALSU9VD070400](#) [UALSU9HF050500](#) [UALSU9H0208000](#) [UALSCF25081300](#) [UAL24VK06450CH](#)
[PLT10HH501100PNB](#) [PLT10HH401100PNB](#) [PLT10HH1026R0PNB](#) [PE-67531](#) [EXC-X4CH120X](#) [TLH10UB 113 0R5](#) [2752041447](#)
[2752045447](#) [CMS3-11-R](#) [7351V](#) [CMF16-153131](#) [744252510](#) [T8116NLT](#) [FE2X10-4-2NL](#) [744253200](#) [744253101](#) [744252220](#) [TX8111NLT](#)
[UAL30VR3500470](#) [CTX01-19077-R](#) [T8003NLT](#)