

F-187U

Electrical Specifications (@25C)

1. Maximum Power: 112.0 VA
2. Primary: 115V 50/60 Hz
3. Secondary: 28.0VCT @ 4.0 Amps
4. Voltage Regulation: 5 % TYP @ full load to no load
5. Temperature Rise: 35C TYP (45C MAX allowed)

Description:

The F-187U is part of a series which has a long history of reliable service in the field, made from a proven design and constructed with UL recognized materials.

Construction:

Wound on a single channel nylon bobbin. Materials are UL recognized, Class B (130° C) rated.

Safety:

These products are 100% hipot tested with an insulation of 1500V between primary and secondary windings as well as between the primary / secondary windings and the core.

Dimensions:

Units: In inches

A	B	C	D	E
3.375	2.812	3.062	2.250	2.75

Lead length: 7.0 inches \pm 1 inch

Weight: 5.30 lbs

Schematic:

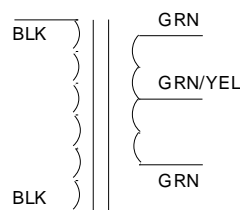

Primary: Black to Black

Secondary: Green to Green

RoHS Compliance: As of manufacturing date February 2016, all standard products meet the requirements of 2015/863/EU, known as the RoHS 3 initiative.

* Upon printing, this document is considered "uncontrolled". Please contact Triad Magnetics' website for the most current version.

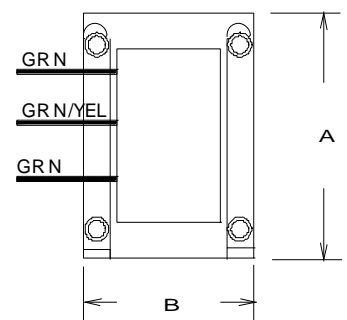
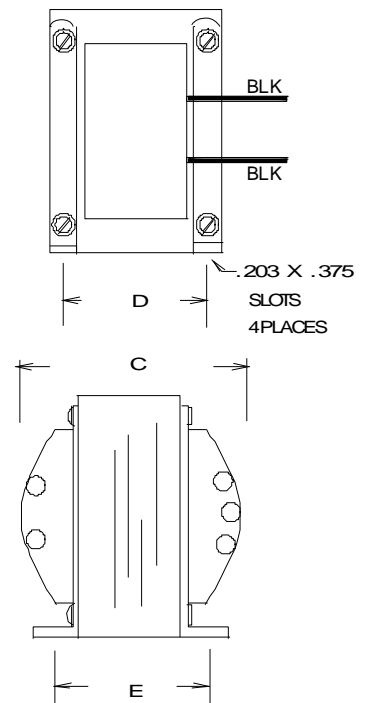

X-ON Electronics

Largest Supplier of Electrical and Electronic Components

Click to view similar products for [Power Transformers](#) category:

Click to view products by [Triad](#) manufacturer:

Other Similar products are found below :

[ET-030A](#) [F-102X](#) [F-120X](#) [F-14X-1](#) [F-181U](#) [F-18A](#) [F-199U](#) [F-19X](#) [F-202U](#) [F-204U](#) [F-206U](#) [F-227X](#) [F-238U](#) [F-239U-1](#) [F-23U](#) [F24-250-B](#)
[F-242U](#) [F-245U](#) [F-264U](#) [F-265U](#) [F-267U](#) [F-281U](#) [F-283U](#) [F-290X](#) [F-295Z](#) [F-296Z](#) [F-298Z](#) [F-3143P](#) [F-3298Z](#) [F-33U](#) [F-346X](#) [F-35U](#) [F-](#)
[364U](#) [F-392A](#) [F-395X](#) [F-397U](#) [F-412X](#) [F-47U](#) [F-55X-1](#) [F-60U](#) [F-68U](#) [F-71U](#) [F-72Z](#) [F-74U](#) [F-83A](#) [F-84AC](#) [F-85U](#) [F-86U](#) [F-9U](#) [PCT-02](#)