

### FD6-12

#### Description:

The FD6-12 Quick Pack small power transformer offers a significant reduction in size and weight over a standard transformer. This transformer can be used for a wide variety of applications. It is bobbin wound for reduced size and small operating space.

#### Electrical Specifications (@25C):

**Maximum Power:** 30.0VA

#### Input Voltage:

**Series:** 230VAC@50/60Hz

**Parallel:** 115VAC@50/60Hz

**Output Voltage:** 12.6VCT@2.5A<sup>1</sup>

**Recommended Fuse:** UL listed 250VAC, 3.0A, Slo-Blo

**Hipot:** 2500VAC primary to secondary; 1500VAC windings to core.

#### Construction:

Split bobbin non concentric winding eliminates costly electrostatic shielding. Termination is suitable for quick connects or soldering. Built with UL Class B Insulation System.

#### Safety:

UL: File E53148, UL 5085-1 and 2 (formerly UL 506), General Purpose.

UL: File E65390, UL5085-1 and 3, Class 2 not wet, Class 3 wet



#### Dimensions:

A	B	C	D	E	F	G
1.937	2.812	3.250	1.687	2.312	.187 Dia	1.062

**Notes:** 1. Units: inches.

2. Terminal size: .187" X 0.021".

3. Weight: 1.10 lbs

#### Schematic:

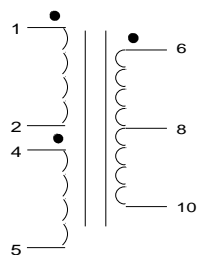

**Output:** 6 & 10

**Input (115V):** Input 1 & 2

Connect 1&4, 2&5

**Input (230V):** Input 1 & 5

Connect 2&4

**RoHS Compliance:** As of manufacturing date February 2016, all standard products meet the requirements of 2015/863/EU, known as the RoHS 3 initiative.

\* Upon printing, this document is considered "uncontrolled". Please contact Triad Magnetics' website for the most current version.

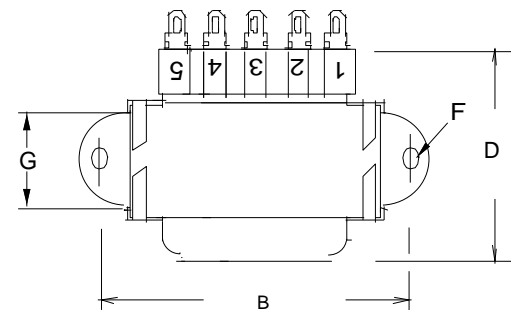
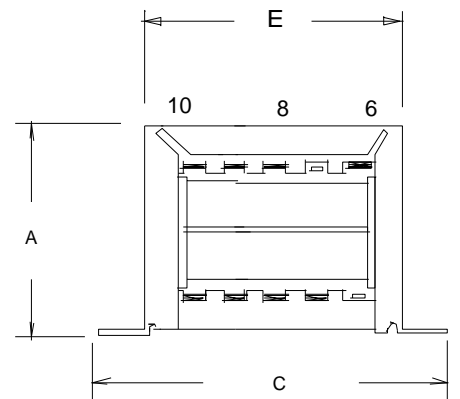
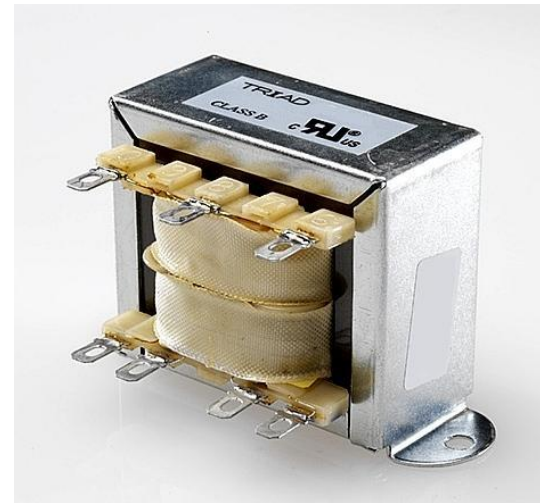

<sup>1</sup> Fuse must be used on **secondary** as conditions of acceptability for UL Class 2/3 operation

## **X-ON Electronics**

Largest Supplier of Electrical and Electronic Components

*Click to view similar products for [Power Transformers](#) category:*

*Click to view products by [Triad](#) manufacturer:*

Other Similar products are found below :

[ET-030A](#) [F-102X](#) [F-120X](#) [F-14X-1](#) [F-181U](#) [F-18A](#) [F-199U](#) [F-19X](#) [F-202U](#) [F-204U](#) [F-206U](#) [F-227X](#) [F-238U](#) [F-239U-1](#) [F-23U](#) [F24-250-B](#)  
[F-242U](#) [F-245U](#) [F-264U](#) [F-265U](#) [F-267U](#) [F-281U](#) [F-283U](#) [F-290X](#) [F-295Z](#) [F-296Z](#) [F-298Z](#) [F-3143P](#) [F-3298Z](#) [F-33U](#) [F-346X](#) [F-35U](#) [F-](#)  
[364U](#) [F-392A](#) [F-395X](#) [F-397U](#) [F-412X](#) [F-47U](#) [F-55X-1](#) [F-60U](#) [F-68U](#) [F-71U](#) [F-72Z](#) [F-74U](#) [F-83A](#) [F-84AC](#) [F-85U](#) [F-86U](#) [F-9U](#) [PCT-02](#)