

FD8-16

Description:

The FD8-16 Quick Pack small power transformer offers a significant reduction in size and weight over a standard transformer. This transformer can be used for a wide variety of applications. It is bobbin wound for reduced size and small operating space.

Electrical Specifications (@25C):

Maximum Power: 100.0VA

Input Voltage:

Series: 230VAC@50/60Hz

Parallel: 115VAC@50/60Hz

Output Voltage: 16.0VCT@6.25A

Hipot: 2500VAC primary to secondary; 1500VAC windings to core.

Construction:

Split bobbin non concentric winding eliminates costly electrostatic shielding. Termination is suitable for quick connects or soldering. Built with UL Class B Insulation System.

Safety:

UL: File E53148, UL 5085-1 and 2 (formerly UL 506), General Purpose.



Dimensions:

A	B	C	D	E	F	G
2.562	3.562	4.031	2.250	3.062	.187 Dia	1.312

- Notes:**
1. Units: inches.
 2. Terminal size: .187" X 0.021".
 3. Weight: 2.75 lbs

Schematic:

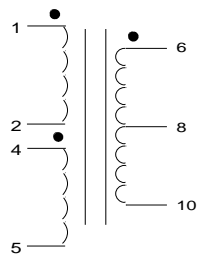

Input (115V): Input 1 & 2
Connect 1&4, 2&5

Input (230V): Input 1 & 5
Connect 2&4

Output: 6 & 10

RoHS Compliance: As of manufacturing date February 2016, all standard products meet the requirements of 2015/863/EU, known as the RoHS 3 initiative.

* Upon printing, this document is considered "uncontrolled". Please contact Triad Magnetics' website for the most current version.

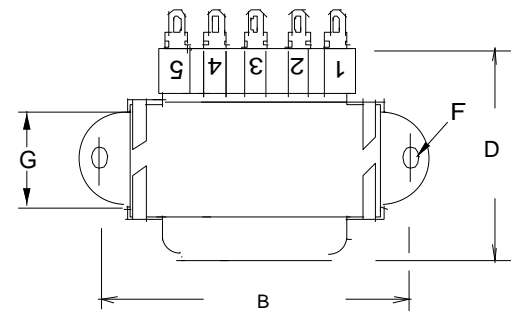
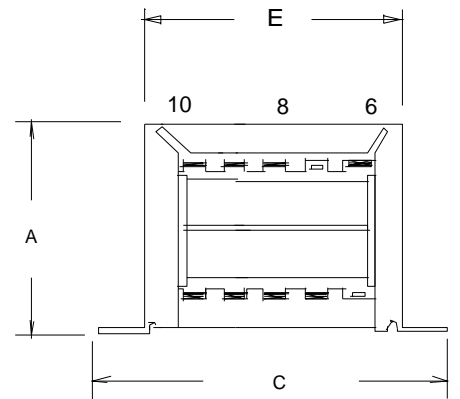

X-ON Electronics

Largest Supplier of Electrical and Electronic Components

Click to view similar products for [Power Transformers](#) category:

Click to view products by [Triad](#) manufacturer:

Other Similar products are found below :

[ET-030A](#) [F-102X](#) [F-120X](#) [F-14X-1](#) [F-181U](#) [F-18A](#) [F-199U](#) [F-19X](#) [F-202U](#) [F-204U](#) [F-206U](#) [F-227X](#) [F-238U](#) [F-239U-1](#) [F-23U](#) [F24-250-B](#)
[F-242U](#) [F-245U](#) [F-264U](#) [F-265U](#) [F-267U](#) [F-281U](#) [F-283U](#) [F-290X](#) [F-295Z](#) [F-296Z](#) [F-298Z](#) [F-3143P](#) [F-3298Z](#) [F-33U](#) [F-346X](#) [F-35U](#) [F-](#)
[364U](#) [F-392A](#) [F-395X](#) [F-397U](#) [F-412X](#) [F-47U](#) [F-55X-1](#) [F-60U](#) [F-68U](#) [F-71U](#) [F-72Z](#) [F-74U](#) [F-83A](#) [F-84AC](#) [F-85U](#) [F-86U](#) [F-9U](#) [PCT-02](#)