

VPL36-300

Electrical Specifications (@25C)

1. Maximum Power: 10.0VA
2. Input Voltage – **Series:** 230VAC @ 50/60Hz, **Parallel:** 115VAC @ 50/60Hz
3. Output Voltage – **Series¹:** 36.0V CT @ 0.280A, **Parallel²:** 18.0V @ 0.560A
4. Voltage Regulation: 20% TYP @ full load to no load
5. Hipot: 3500VAC between primary to secondary and windings to core.

Construction:

Dual winding construction with an insulated shroud, both made of a high temperature material that exceeds UL flammability requirements. Shrouds are provided over the connections of the leads to the windings on both primary and secondary coils. Devices are designed with a minimum of 6mm creepage distance between the primary and secondary and are manufactured with a Class B (130°C) insulation system.

Agency Files:

UL File: E65390, UL 5085-1 and 3 (formerly UL1585), Class 2/3
 cUL: File E65390, For Canadian Use (CSA 22.2, No.66.1-06 and No.66.3-06)
 TUV: File R72182067, EN 61558-1:2005+A1, EN61558-2-6:2009. Double Insulated. Non-inherently Short-Circuit-Proof.



Dimensions: Units: In inches

A	B	C	D	E	F
1.750	2.812	1.750	2.375	8.00	0.187

Weight: 0.7 lbs.

Connections³:

Input: Series – BLK to BLU, Jumper WHT to BRN
 Parallel – BLK to BLU, Jumper BLK to BRN and WHT to BLU

Output: Series – RED to GRY, Jumper YEL to VIO
 Parallel – RED to GRY, Jumper RED to VIO and YEL to GRY

RoHS Compliance: As of manufacturing date February 2016, all standard products meet the requirements of 2015/863/EU, known as the RoHS 3 initiative.

* Upon printing, this document is considered "uncontrolled". Please contact Triad Magnetics' website for the most current version.

¹ Inherently limited. No fusing required. Class 3.

² Inherently limited. No fusing required. Class 2 not wet, Class 3 wet.

³ Primary and secondary windings are designed to be connected in series or parallel. Windings are not intended to be used independently.

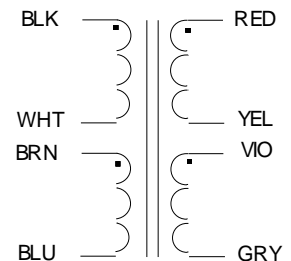
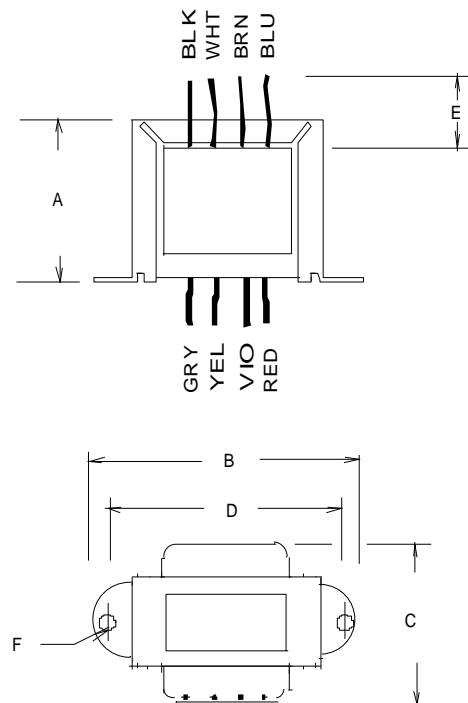
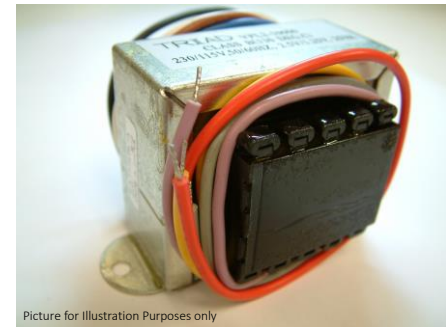

SCHEMATIC

X-ON Electronics

Largest Supplier of Electrical and Electronic Components

Click to view similar products for [Power Transformers](#) category:

Click to view products by [Triad](#) manufacturer:

Other Similar products are found below :

[ET-030A](#) [F-102X](#) [F-120X](#) [F-14X-1](#) [F-181U](#) [F-18A](#) [F-199U](#) [F-19X](#) [F-202U](#) [F-204U](#) [F-206U](#) [F-227X](#) [F-238U](#) [F-239U-1](#) [F-23U](#) [F24-250-B](#)
[F-242U](#) [F-245U](#) [F-264U](#) [F-265U](#) [F-267U](#) [F-281U](#) [F-283U](#) [F-290X](#) [F-295Z](#) [F-296Z](#) [F-298Z](#) [F-3143P](#) [F-3298Z](#) [F-33U](#) [F-346X](#) [F-35U](#) [F-](#)
[364U](#) [F-392A](#) [F-395X](#) [F-397U](#) [F-412X](#) [F-47U](#) [F-55X-1](#) [F-60U](#) [F-68U](#) [F-71U](#) [F-72Z](#) [F-74U](#) [F-83A](#) [F-84AC](#) [F-85U](#) [F-86U](#) [F-9U](#) [PCT-02](#)