

VPT24-10420

Electrical Specifications (@25C)

1. Maximum Power: 250VA
2. Input Voltage: **Series:** 230VAC, 50/60Hz
Parallel: 115VAC, 50/60Hz
3. Output Voltage: **Series:** 24VAC CT @ 10.42A
Parallel: 12.0VAC @ 20.84A
4. Voltage Regulation: 7% TYP from full load to no load
5. Temperature Rise: 50°C TYP
6. Hipot: 4000VAC, Primary to Secondary
7. Efficiency: 90% TYP. @ full load

Construction:

The toroidal construction inherently helps reduce stray fields, increases efficiency and minimizes size compared to traditional EI transformers. Built with Class B (130°) insulation system.

Safety:

World Series Transformers are designed and manufactured to meet most International Safety agency standards.

Agency File:

UL: File E122529, UL 5085-1 & 2
CE: EN 61558-1:2005, EN 61558-2-6:1995, Low Voltage Directive (LVD)
EN 6-000-6-6:2001+A11:2004, EN 55014-1:2000+A1:2001+A2:2002, EN
6100-6-1:2001, EN 55014-2:1997+A1:2001, Electromagnetic Compatibility (EMC)



Dimensions (mm):

H*	I.D.	O.D.
58.0 Max	31.0 Min	112.0 Max

*Add 3mm to the height for mounting hardware
Weight: 2.2Kg

Mounting:

Transformer is provided with one metal mounting plate, two rubber pads, M6 x 65mm bolt, nut, spring and flat washer.

Connections:

Transformer is provided with 8" (200mm) long, 0.25" (6mm) stripped and tinned, stranded UL 1015 lead wire. Primaries are 20AWG, Secondaries are 14AWG.

Input¹: Series – BLUE and BROWN, Jumper GRAY to VIOLET
Parallel – BLUE and BROWN, Jumper BLUE to VIOLET, GRAY to BROWN

Output¹: Series – BLACK and YELLOW, Jumper RED to ORANGE
Parallel – BLACK and YELLOW, Jumper BLACK to ORANGE, RED to YELLOW

RoHS Compliance: As of manufacturing date February 2016, all standard products meet the requirements of 2015/863/EU, known as the RoHS 3 initiative.

* Upon printing, this document is considered "uncontrolled". Please contact Triad Magnetics' website for the most current version.

¹ Primary and secondary windings are designed to be connected in series or parallel. Windings are not intended to be used independently.

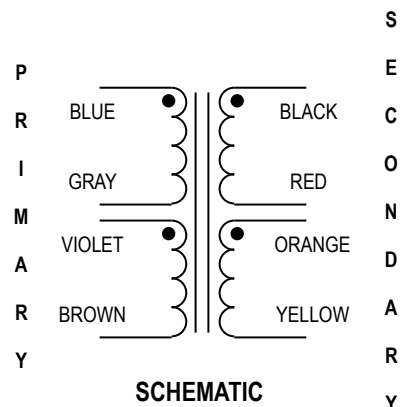
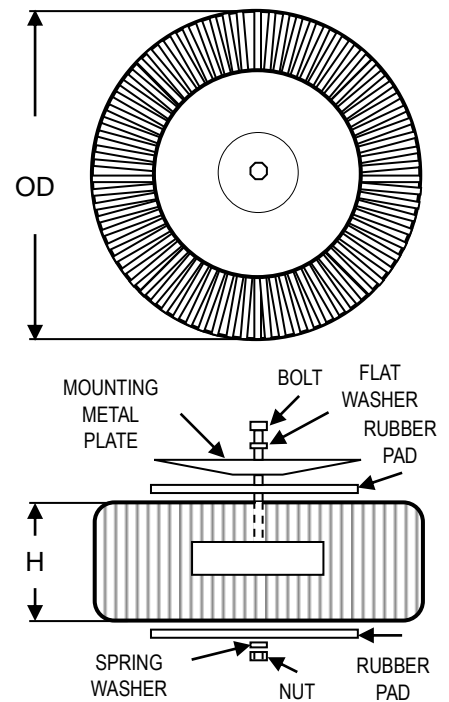

X-ON Electronics

Largest Supplier of Electrical and Electronic Components

Click to view similar products for [Power Transformers](#) category:

Click to view products by [Triad](#) manufacturer:

Other Similar products are found below :

[ET-030A](#) [F-102X](#) [F-120X](#) [F-14X-1](#) [F-181U](#) [F-18A](#) [F-199U](#) [F-19X](#) [F-202U](#) [F-204U](#) [F-206U](#) [F-227X](#) [F-238U](#) [F-239U-1](#) [F-23U](#) [F24-250-B](#)
[F-242U](#) [F-245U](#) [F-264U](#) [F-265U](#) [F-267U](#) [F-281U](#) [F-283U](#) [F-290X](#) [F-295Z](#) [F-296Z](#) [F-298Z](#) [F-3143P](#) [F-3298Z](#) [F-33U](#) [F-346X](#) [F-35U](#) [F-](#)
[364U](#) [F-392A](#) [F-395X](#) [F-397U](#) [F-412X](#) [F-47U](#) [F-55X-1](#) [F-60U](#) [F-68U](#) [F-71U](#) [F-72Z](#) [F-74U](#) [F-83A](#) [F-84AC](#) [F-85U](#) [F-86U](#) [F-9U](#) [PCT-02](#)