

## VPT30-3330

### Electrical Specifications (@25C)

1. Maximum Power: 100VA
2. Input Voltage: **Series:** 230VAC, 50/60Hz  
**Parallel:** 115VAC, 50/60Hz
3. Output Voltage: **Series:** 30VAC CT @ 3.33A  
**Parallel:** 15.0VAC @ 6.66A
4. Voltage Regulation: 9% TYP from full load to no load
5. Temperature Rise: 45°C TYP
6. Hipot: 4000VAC, Primary to Secondary
7. Efficiency: 89% TYP. @ full load

### Construction:

The toroidal construction inherently helps reduce stray fields, increases efficiency and minimizes size compared to traditional EI transformers. Built with Class B (130°) insulation system.

### Safety:

World Series Transformers are designed and manufactured to meet most International Safety agency standards.

### Agency File:

UL: File E122529, UL 5085-1 & 2  
 CE: EN 61558-1:2005, EN 61558-2-6:1995, Low Voltage Directive (LVD)  
 EN 6-000-6-6:2001+A11:2004, EN 55014-1:2000+A1:2001+A2:2002, EN  
 6100-6-1:2001, EN 55014-2:1997+A1:2001, Electromagnetic Compatibility (EMC)



Dimensions (mm):

H*	I.D.	O.D.
51.0 Max	26.0 Min	88.0 Max

\*Add 3mm to the height for mounting hardware  
 Weight: 1.0Kg

### Mounting:

Transformer is provided with one metal mounting plate, two rubber pads, M6 x 55mm bolt, nut, spring and flat washer.

### Connections:

Transformer is provided with 8" (200mm) long, 0.25" (6mm) stripped and tinned, stranded UL 1015 lead wire. Primaries are 22AWG, Secondaries are 18AWG.

**Input<sup>1</sup>:** Series – BLUE and BROWN, Jumper GRAY to VIOLET  
 Parallel – BLUE and BROWN, Jumper BLUE to VIOLET, GRAY to BROWN

**Output<sup>1</sup>:** Series – BLACK and YELLOW, Jumper RED to ORANGE  
 Parallel – BLACK and YELLOW, Jumper BLACK to ORANGE, RED to YELLOW

**RoHS Compliance:** As of manufacturing date February 2016, all standard products meet the requirements of 2015/863/EU, known as the RoHS 3 initiative.

\* Upon printing, this document is considered "uncontrolled". Please contact Triad Magnetics' website for the most current version.

<sup>1</sup> Primary and secondary windings are designed to be connected in series or parallel. Windings are not intended to be used independently.

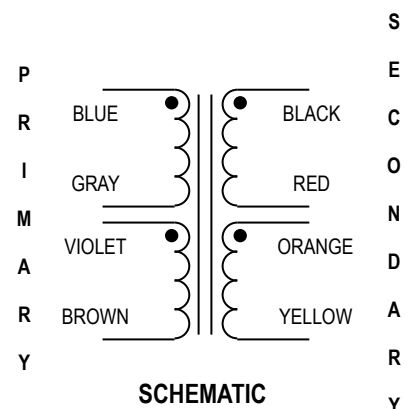
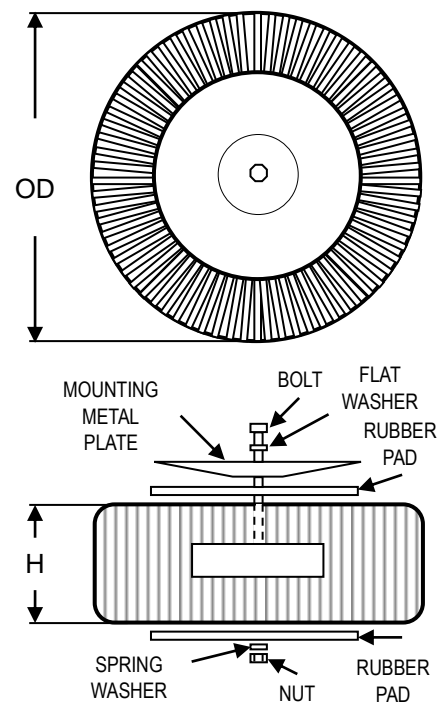

## **X-ON Electronics**

Largest Supplier of Electrical and Electronic Components

*Click to view similar products for [Power Transformers](#) category:*

*Click to view products by [Triad](#) manufacturer:*

Other Similar products are found below :

[ET-030A](#) [F-102X](#) [F-120X](#) [F-14X-1](#) [F-181U](#) [F-18A](#) [F-199U](#) [F-19X](#) [F-202U](#) [F-204U](#) [F-206U](#) [F-227X](#) [F-238U](#) [F-239U-1](#) [F-23U](#) [F24-250-B](#)  
[F-242U](#) [F-245U](#) [F-264U](#) [F-265U](#) [F-267U](#) [F-281U](#) [F-283U](#) [F-290X](#) [F-295Z](#) [F-296Z](#) [F-298Z](#) [F-3143P](#) [F-3298Z](#) [F-33U](#) [F-346X](#) [F-35U](#) [F-](#)  
[364U](#) [F-392A](#) [F-395X](#) [F-397U](#) [F-412X](#) [F-47U](#) [F-55X-1](#) [F-60U](#) [F-68U](#) [F-71U](#) [F-72Z](#) [F-74U](#) [F-83A](#) [F-84AC](#) [F-85U](#) [F-86U](#) [F-9U](#) [PCT-02](#)