

WDU24-200

Electrical Specifications (@25C)

1. Primary Rating: 120V 60Hz (9W @ Full Load)
2. Primary Excitation Current: 45mA Max
3. Secondary Rating: 24VDC \pm 5%, 200mADC
4. Secondary No-Load Rating: 39.30VDC Ref.
5. Output Ripple Voltage: 900mV Max
6. Operating Temperature Range: -10 Deg C to +40 Deg C
7. Temperature Rise: 75 Deg C Max at rated load
50 Deg C Max on enclosure surface

Mechanical Parameters:

Case Type: Thermoplastic molded enclosure.
Output Cord: 24 AWG, 6 Ft. Long Min.

Agency File:

UL/CUL: File E245587, UL 1310

A. Dimensions:

H	W	D
60	43	39

*Units: In Millimeter

B. Schematic:

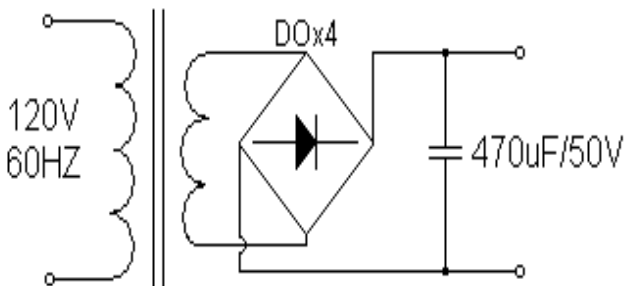

Technical Note: 1. Inside (tip)-positive (+), outside-negative (-)

DOE Compliance: Effective December 30, 2017, the DOE will now not consider an external power supply with specific characteristics to meet the definition of a device that is subject to EPCA regulation, as long as the power supply is not distributed for use with consumer products.

RoHS Compliance: As of manufacturing date February 2016, all standard products meet the requirements of 2015/863/EU, known as the RoHS 3 initiative.

* Upon printing, this document is considered "uncontrolled". Please contact Triad Magnetics' website for the most current version.

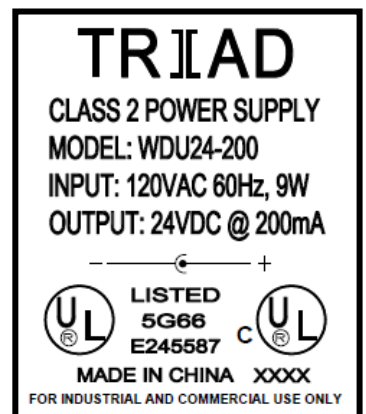
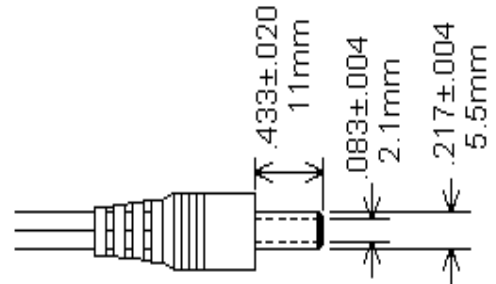
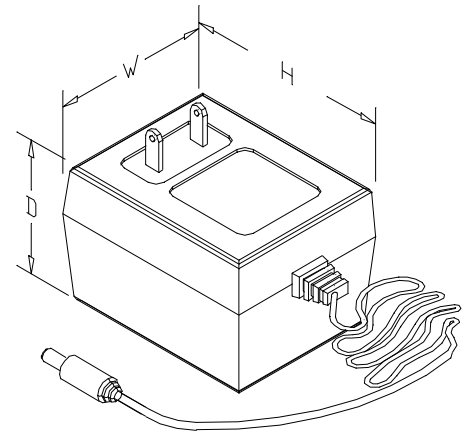

X-ON Electronics

Largest Supplier of Electrical and Electronic Components

Click to view similar products for [Wall Mount AC Adapters](#) category:

Click to view products by [Triad](#) manufacturer:

Other Similar products are found below :

[ADP-163 E](#) [ADP-167 J](#) [ADP-168 K](#) [ADP-159 A](#) [ADP-165 G](#) [PSAC05A-050L6](#) [RLMDT361800](#) [P25A14E-R1C](#) [DA10-050CH](#) [DA5-050US-B](#) [DA10-050UK](#) [RLMDT701800](#) [WSU120-2000-R13](#) [WSU180-1330-13](#) [AC-DC ADAPTER 160W](#) [WSU120-2000-13](#) [WSU150-0800-13](#) [WSU075-3200-13](#) [WSU060-2000-R13](#) [WSU090-2500-13](#) [WSU050-2000-R13](#) [WSU240-1000-13](#) [WSU240-0500-R13](#) [WSU075-1500-13](#) [WSU050-3000-13](#) [WSU120-1500-13](#) [WSU120-1500-R13](#) [WSU045-1500-13](#) [WSU240-0750-13](#) [WSU090-2500-R13](#) [WSU240-1500-13](#) [WSU180-0660-13](#) [WSU075-1500-R13](#) [WSU090-1300-13](#) [WSU180-1330-R13](#) [BB-SMI1812VP230C1](#) [WSU050-1500-13](#) [WSU090-0800-13](#) [WSU120-0700-13](#) [WSU045-3000-13](#) [WSU180-0450-13](#) [WSU150-0560-R13](#) [WSU135-0880-13](#) [WSU120-3000-13](#) [WSU120-1000-R13](#) [WSU090-1300-R13](#) [WSU060-1250-R13](#) [WSU060-1250-13](#) [WSU045-2000-R13](#) [WSU045-1500-R13](#)