

WSU240-0750-R13

Electrical Specifications (@25C)

1. Input Voltage rating: 100-240VAC, 50-60Hz
2. Input Voltage range: 90-264VAC
3. Input current: <0.5A(RMS) @ 115VAC
4. Max Inrush Current: <80A peak @ 115VAC (Cold start)
5. Output Voltage: 24VDC
6. Output Current: 0.75A
7. Regulation (line & load): ±5%
8. Ripple & Noise: 150mVpk-pk Max
9. No load power (stand by): <100mW
10. Average Efficiency: ≥85.0%. Meets minimum level VI efficiency.

Environmental Specifications

1. Operating Temperature Range: 0°C to +40° C @ full load
2. Storage Temperature Range: -20°C to 60°C
3. Humidity: 5% to 95%, Non-condensing

Reliability Specifications

1. Leakage Current: <0.25mA (264VAC)
2. Dielectric Strength (Hi-pot): 4242VDC/3secs., 5mA Max
3. Warranty: 5 years

Mechanical Parameters

Case Type: Thermoplastic molded enclosure.
Output Cord: 24 AWG, 6 Ft. Long Nom.

Safety & EMI

UL: 62368-1 Class II, Double Insulated
UL File Number: E345519
EMI standard: FCC part15 Subpart B, ICES-003 Issue 6, ANSI C63.4-2014
Over voltage and short circuit protected



EISA 2007/CEC Compliance: All WSU Power Supplies manufactured after February 10, 2016 will meet the minimum efficiency levels for direct operation as defined by DOE Docket Number EERE-2008-BT-STD-0005-0219. Triad's level VI products will have date code no later than 1605 (YYWW) where 16 is the year and 05 is the 5th week of 2016. In accordance with DOE requirement the label will also contain the Roman numeral VI with a circle.

RoHS Compliance: As of manufacturing date February 2016, all standard products meet the requirements of 2015/863/EU, known as the RoHS 3 initiative.

Upon printing, this document is considered "uncontrolled". Please contact Triad Magnetics' website for the most current version.

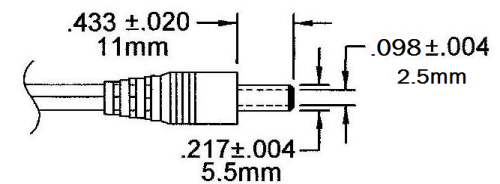
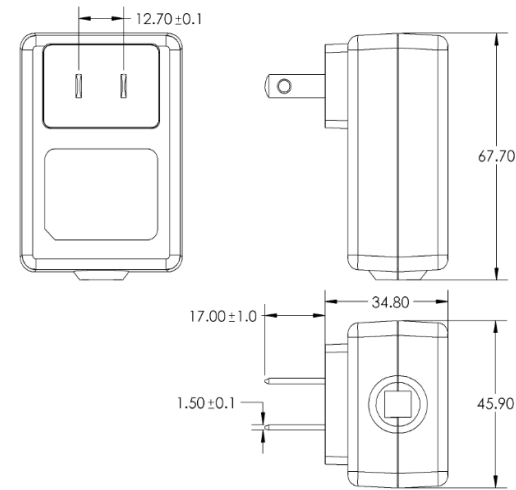

Dim.: mm

X-ON Electronics

Largest Supplier of Electrical and Electronic Components

Click to view similar products for [Wall Mount AC Adapters](#) category:

Click to view products by [Triad](#) manufacturer:

Other Similar products are found below :

[ADP-163 E](#) [ADP-167 J](#) [ADP-168 K](#) [ADP-159 A](#) [ADP-165 G](#) [PSAC05A-050L6](#) [RLMDT361800](#) [DA10-050CH](#) [DA5-050US-B](#)
[RLMDT701800](#) [WSU120-2000-R13](#) [WSU180-1330-13](#) [AC-DC ADAPTER 160W](#) [WSU120-2000-13](#) [WSU150-0800-13](#) [WSU075-3200-13](#)
[WSU060-2000-R13](#) [WSU090-2500-13](#) [WSU050-2000-R13](#) [WSU240-1000-13](#) [WSU240-0500-R13](#) [WSU075-1500-13](#) [WSU050-3000-13](#)
[WSU120-1500-13](#) [WSU120-1500-R13](#) [WSU045-1500-13](#) [WSU240-0750-13](#) [WSU090-2500-R13](#) [WSU240-1500-13](#) [WSU180-0660-13](#)
[WSU075-1500-R13](#) [WSU090-1300-13](#) [WSU180-1330-R13](#) [BB-SMI1812VP230C1](#) [WSU050-1500-13](#) [WSU090-0800-13](#) [WSU120-0700-13](#)
[WSU045-3000-13](#) [WSU180-0450-13](#) [WSU150-0560-R13](#) [WSU135-0880-13](#) [WSU120-3000-13](#) [WSU120-1000-R13](#) [WSU090-1300-R13](#)
[WSU060-1250-R13](#) [WSU060-1250-13](#) [WSU045-2000-R13](#) [WSU045-1500-R13](#) [PSAC05A-050L6M](#) [392007-01](#)