



Driver LCO 75W 200–1400mA flexC 0-10V NF L SNC3 essence NFC outdoor series

Product description

- Constant current LED driver
- Tested acc. to salt spray test (ISO 9227)
- Dimmable via 0 ... 10 V interface (incl. stand-by)
- Dimming range 1 – 100 %
- Adjustable output current between 200 and 1,400 mA via NFC
- Max. output power 75 W
- Up to 88 % efficiency
- Nominal lifetime up to 50,000 h
- 5 years guarantee (conditions at www.tridonic.com)



Housing properties

- Casing: metal, black
- Type of protection IP67 and IP66

Functions

- Adjustable output current in 1-mA-steps (NFC)
- AUX output
- Fade-off time programmable
- Configurable external temperature management (ETM)
- Protective features (overtemperature, short-circuit, overload, no-load)

Benefits

- Operating windows for maximum compatibility
- Added energy savings with dimming via 0 ... 10 V interface
- Configurable via NFC
- Tailor your dimming response with either Linear, Logarithmic or Square Dimming Curves

Typical applications

- For parking lot, high bay, street and road applications
- For linear or area lighting in industry applications



Standards, page 3



Driver LCO 75W 200–1400mA flexC 0-10V NF L SNC3

essence NFC outdoor series

Technical data

Rated supply voltage	100 – 277 V
AC voltage range	90 – 305 V
Mains frequency	50 / 60 Hz
Typ. current (at 230 V, 50 Hz, full load) ^①	420 mA
Leakage current (at 230 V, 50 Hz, full load) ^②	< 750 µA
Max. input power (at 230 V, 50 Hz, full load)	92 W
Typ. efficiency (at 230 V, 50 Hz, full load) ^②	88 %
λ (at 230 V, 50 Hz, full load) ^③	0.95
Typ. power consumption on stand-by (at 230 V, 50 Hz) ^④	< 0.39 W
Typ. input current in no-load operation (at 230 V, 50 Hz)	37 mA
Typ. input power in no-load operation (at 230 V, 50 Hz)	3.2 W
In-rush current (peak / duration at 230 V)	50 A / 180 µs
THD (at 230 V, 50 Hz, full load) ^⑤	< 15 %
Starting time (at 230 V, full load) ^⑥	≤ 500 ms
Turn off time (full load)	< 30 ms
Hold time (power failure, full load)	< 20 ms
Output current tolerance ^⑦	± 5 %
Max. output current peak (non-repetitive)	≤ output current + 10 %
Output LF current ripple (< 120 Hz)	± 5 %
Output P _{st} ^{LM} (at full load)	≤ 1
Output SVM (at full load)	≤ 0.4
Max. output voltage	210 V
Dimming range	1 – 100 %
Mains surge capability (between L - N)	6 kV
Mains surge capability (between L/N - PE)	10 kV
Surge voltage at output side (against PE)	2 kV
Type of protection	IP67 & IP66
Lifetime	up to 50,000 h
Guarantee (conditions at www.tridonic.com)	5 years
Dimensions L x W x H	213 x 61 x 37.8 mm

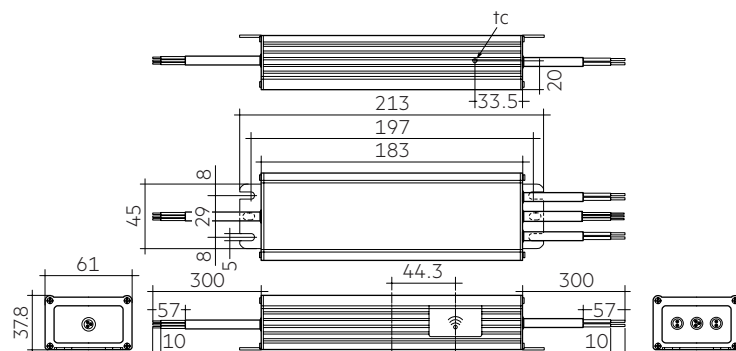

Ordering data

Type	Article number	Packaging carton	Packaging. pallet	Weight per pc.
LCO 75/200-1400 flexC 0-10V NF L SNC3	28003555	10 pc(s).	420 pc(s).	0.930 kg

Specific technical data

Type	Output current ^⑧	Min. forward voltage	Max. forward voltage	Max. output power (at 230 V, 50 Hz, full load)	Typ. power consumption (at 230 V, 50 Hz, full load)	Typ. current consumption (at 230 V, 50 Hz, full load)	t _c temperature	Ambient temperature t _a max.
LCO 75/200-1400 flexC 0-10V NF L SNC3	200 mA	27 V	1500 V	30.0 W	34.9 W	159 mA	90 °C	-40 ... +60 °C
	500 mA	27 V	1500 V	75.0 W	82.0 W	359 mA	90 °C	-40 ... +60 °C
	800 mA	27 V	93.8 V	75.0 W	82.0 W	359 mA	90 °C	-40 ... +60 °C
	1,100 mA	27 V	68.2 V	75.0 W	82.7 W	362 mA	90 °C	-40 ... +60 °C
	1,400 mA	27 V	53.5 V	74.9 W	84.0 W	368 mA	90 °C	-40 ... +60 °C

① Valid at 100 % dimming level.

② Depending on the selected output current.

③ With load on AUX port higher.

④ The table only lists a number of possible operating points but does not cover each single point. The output current can be set within the total value range in 1-mA-steps.

⑤ Output current is mean value.

1. Standards

- EN 55015
- EN 61000-3-2
- EN 61000-3-3
- EN 61347-1
- EN 61347-2-13
- EN 61547
- EN 62384
- EN 60598-1
- FCC Part 15, Class B

2. Thermal details and lifetime

2.1 Expected lifetime

Expected lifetime 230 V

Type	ta	45 °C	50 °C	60 °C
LCO 75/200-1400 flexC 0-10V NF L SNC3	tc	75 °C	80 °C	90 °C
	Lifetime	55,000 h	50,000 h	40,000 h

The LED driver is designed for a lifetime stated above under reference conditions and with a failure probability of less than 10 %.

The relation of tc to ta temperature depends also on the luminaire design.

If the measured tc temperature is approx. 5 K below tc max., ta temperature should be checked and eventually critical components (e.g. ELCAP) measured. Detailed information on request.

3. Installation / wiring

3.1 Circuit diagram

0 – 10 V dimmer and sensor in a closed network:

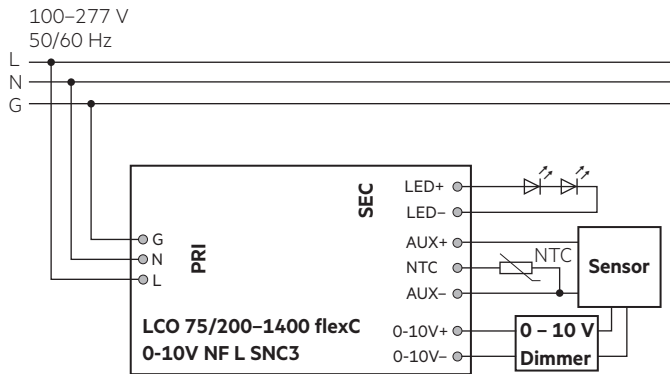

Re-inforced sensor:

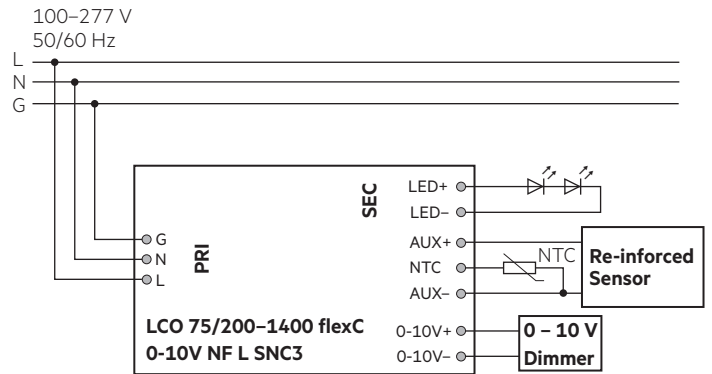

3.2 Connection

Primary cable			Secondary cable						
L	N	PE	+	-	AUX+	NTC	AUX-	0-10V+	0-10V-
brown	blue	green/yellow	brown	blue	yellow	brown	blue	purple	pink

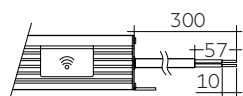

PRI:
3x1.0 mm²

SEC:
2x1.0 mm²

3.4 Wiring instructions

- All connections must be kept as short as possible to ensure good EMI behaviour
- Mains leads should be kept apart from LED driver and other leads (ideally 5 – 10 cm distance)
- The maximum length of output wires is 3 m.
- Secondary switching is not permitted.
- Incorrect wiring can damage LED modules.
- To avoid the damage of the Driver, the wiring must be protected against short circuits to earth (sharp edged metal parts, metal cable clips, louver, etc.).

3.4 Installation instructions

The switching of LEDs on secondary side is not permitted.

3.5 Fixing conditions

Acidfree, oilfree, fatfree. It is not allowed to exceed the maximum ambient temperature (ta) stated on the device. Minimum distances stated below are recommendations and depend on the actual luminaire. Is not suitable for fixing in corner. Terminals according to EN 60998-2-1 or EN 60998-2-2 are required.

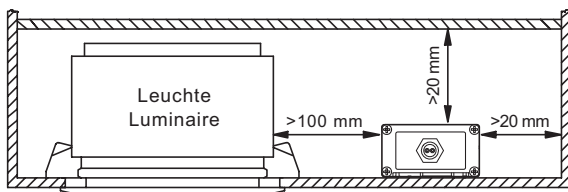

3.6 Earth connection

The earth connection is conducted as protection earth (PE). If the LED Driver will be earthed, protection earth (PE) has to be used. Earth connection is recommended to improve following behaviour:

- Electromagnetic interferences (EMI)
- Transmission of mains transients to the LED output

In general it is recommended to earth the LED driver if the LED module is mounted on earthed luminaire parts respectively heat sinks and thereby representing a high capacity against earth.

4. Electrical values

4.1 Operating window

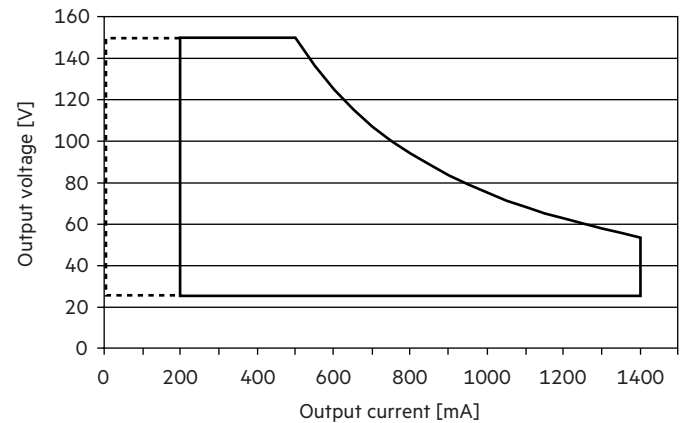

- Operating window 100 %
- - - Operating window dimmed

Make sure that the LED driver is operated within the given window under all operating conditions. Special attention needs to be paid at dimming as the forward voltage of the connected LED modules varies with the dimming level, due to the implemented amplitude dimming technology. Coming below the specified minimum output voltage of the LED driver may cause the device to shut-down.

4.2 Efficiency vs load

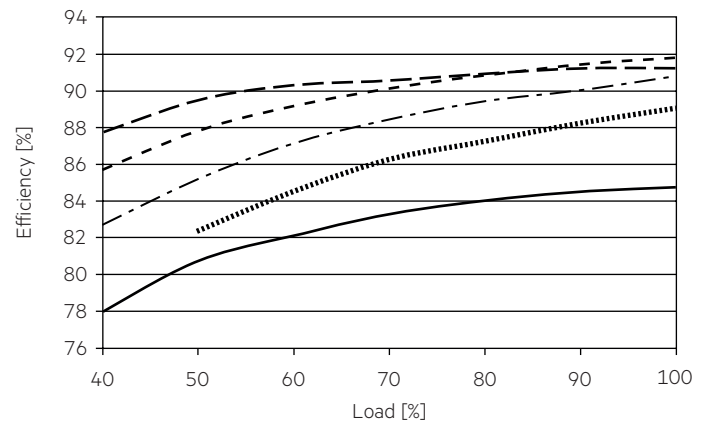

4.3 Power factor vs load

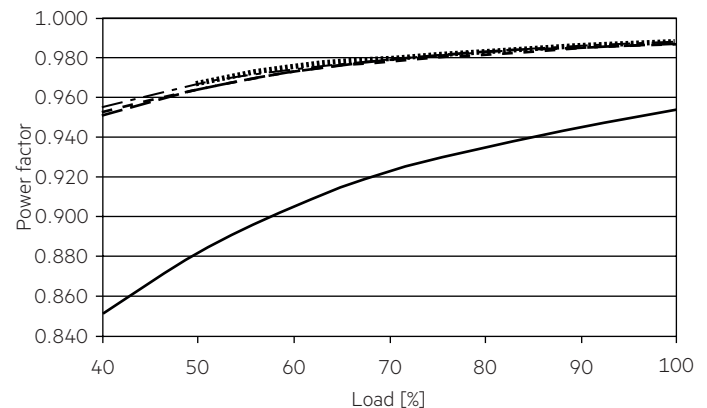

4.4 THD vs load (without harmonic < 5 mA or 0.6 % of the input current)

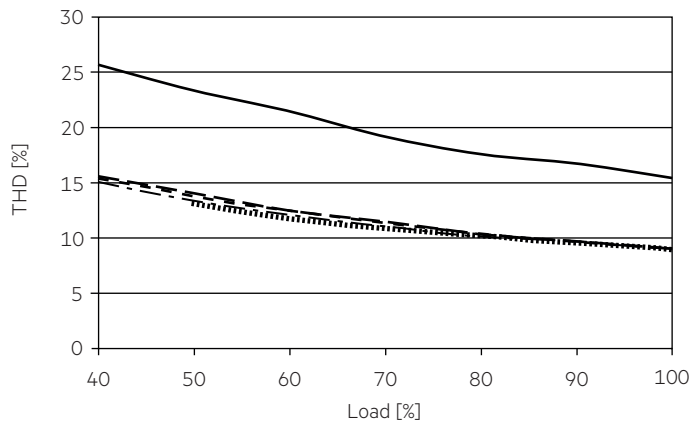

- 200 mA
- 500 mA
- - - - - 800 mA
- · · · · 1100 mA
- · · · · 1400 mA

100 % load corresponds to the max. output power (full load) according to the table on page 3.

4.5 Maximum loading of automatic circuit breakers in relation to inrush current

120 V, 60 Hz:

Automatic circuit breaker type	C10	C13	C16	C20	B10	B13	B16	B20	Inrush current	
Installation Ø	1.5 mm ² / AWG16	1.5 mm ² / AWG16	2.5 mm ² / AWG14	2.5 mm ² / AWG14	1.5 mm ² / AWG16	1.5 mm ² / AWG16	2.5 mm ² / AWG14	2.5 mm ² / AWG14	I _{max}	time
LCO 75/200-1400 flexC 0-10V NF L SNC3	15	19	24	30	27	36	45	56	26 A	180 µs

230 V, 50 Hz:

Automatic circuit breaker type	C10	C13	C16	C20	B10	B13	B16	B20	Inrush current	
Installation Ø	1.5 mm ² / AWG16	1.5 mm ² / AWG16	2.5 mm ² / AWG14	2.5 mm ² / AWG14	1.5 mm ² / AWG16	1.5 mm ² / AWG16	2.5 mm ² / AWG14	2.5 mm ² / AWG14	I _{max}	time
LCO 75/200-1400 flexC 0-10V NF L SNC3	8	9	12	15	14	18	22	28	50 A	180 µs

277 V, 60 Hz:

Automatic circuit breaker type	C10	C13	C16	C20	B10	B13	B16	B20	Inrush current	
Installation Ø	1.5 mm ² / AWG16	1.5 mm ² / AWG16	2.5 mm ² / AWG14	2.5 mm ² / AWG14	1.5 mm ² / AWG16	1.5 mm ² / AWG16	2.5 mm ² / AWG14	2.5 mm ² / AWG14	I _{max}	time
LCO 75/200-1400 flexC 0-10V NF L SNC3	7	9	11	14	13	16	21	26	62 A	150 µs

These are max. values calculated out of inrush current! Please consider not to exceed the maximum rated continuous current of the circuit breaker. Calculation uses typical values from ABB series S200 as a reference. Actual values may differ due to used circuit breaker types and installation environment.

4.6 Harmonic distortion in the mains supply (at 230 V / 50 Hz and full load) in %

	THD	3.	5.	7.	9.	11.
LCO 75/200-1400 flexC 0-10V NF L SNC3	< 10	< 10	< 3	< 3	< 2	< 2

Acc. to 6100-3-2. Harmonics < 5 mA or < 0.6 % (whatever is greater) of the input current are not considered for calculation of THD.

4.7 Dimming

Dimming range is 1 to 100%.

The operating window shows the minimum reachable power in dimmed state.

4.8 Dimming characteristics

Control input (0 – 10 V)

Control input open	max. dimming level
Output current range	20 – 200 μ A \pm 3 %
Max. permitted input voltage	- 2 V / + 15 V
Voltage range dimming	0 – 10 V ^①
Input voltage < 1 V	stand-by
Input voltage = 1 V	min. dimming level ^①
Input voltage > 10 V	max. dimming level ^①

Interface supports current sink dimmers.

Interface is class 2.

^① See graph below (at full load):

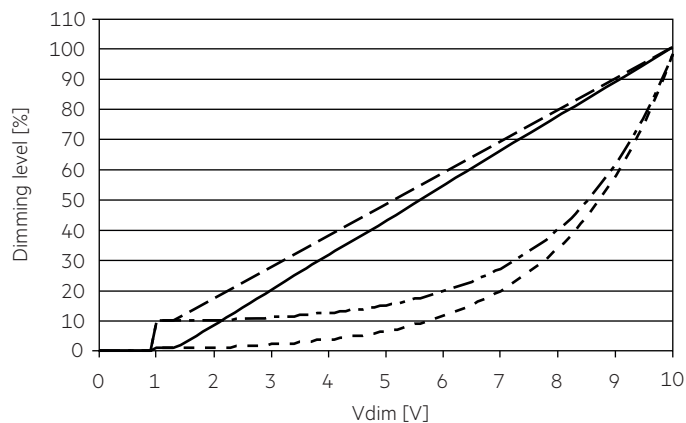

- Soft-linear dimming curve 1 % min. to 0
- - - Linear dimming curve 10 % min. to 0
- . - . Logarithmic dimming curve 1 % min. to 0
- Square dimming curve 10 % min. to 0

Dimming profiles programmable via NFC.

4.9 Insulation between terminals

Insulation	Mains	-LED / +LED	DIM+/DIM-	AUX	NTC	Functional earth
Mains	-	double	double	double	double	basic
-LED / +LED	double	-	basic	-	-	basic
DIM+/DIM-	double	basic	-	basic	basic	basic
AUX	double	-	basic	-	-	basic
NTC	double	-	-	-	-	basic
Functional earth	basic	basic	basic	basic	basic	-

basic ... represents basic insulation.

double ... represents double or reinforced insulation.

5. Software / Programming / Interfaces

5.1 Software / programming

With appropriate software and interface different functions can be activated and various parameters can be configured in the LED driver. The Driver supports the following software and interfaces:

Software / hardware for configuration:

- companionSUITE (deviceGENERATOR, deviceCONFIGURATOR, deviceANALYSER)

Interfaces for data transfer:

- NFC

5.2 Nearfield communication (NFC)

The NFC Interface allows wireless communication with the LED driver. This interface offers the option to write configuration and to read configuration, errors and events with the companionSUITE. A correct communication between the LED driver and the NFC antenna can only be guaranteed if the Driver is directly placed on the antenna. Any material placed between the LED driver and the NFC antenna can cause a deterioration of the communication quality. We recommend the use of following NFC antennas: www.tridonic.com/nfc-readers







NFC is compliant with ISO/IEC 15693 standard.

6. Functions

☉ companionSUITE:

NFC

The companionSUITE with deviceGENERATOR, deviceCONFIGURATOR and deviceANALYSER is available via our WEB page: <https://www.tridonic.com/com/en/products/companionsuite.asp>

Icon	Function	NFC
	OEM Identification	☉
	OEM GTIN	☉
	LED current	☉
	Dimming curve (0-10V)	☉
	Minimum level (0-10V)	☉
	Fade-off time (0-10V)	☉
	External temperature management (ETM + NTC)	☉

6.1 LED current



The LED output current must be adapted to the connected LED module. The value is limited by the current range of the respective device.

6.2 Integrated auxiliary power supply (AUX)

Auxiliary power supply to connect external sensor.

For wiring see circuit diagram.

Output voltage: 22 – 26 V

Output current: 100 mA max.

AUX port is active in stand-by mode.

AUX port should be connected to such a component with sufficient insulation to create a closed network between AUX and 0 – 10 V port or sensor with re-inforced insulation should be connected to AUX as a single component.

6.3 External temperature management (ETM + NTC)



ETM protects the LED module against thermal overstress.

An external temperature sensor (NTC) detects the LED module temperature and the LED driver will limit the output current according to this temperature:

If the temperature is between the limits T1 (normal condition) and T2 (overload), the LED output current will be decreased.

If the temperature exceeds the limit T3 (critical temperature), the device will switch to the shutdown level.

The shutdown level will be active until the module temperature decreases below T1 or until the LED driver is restarted (switch off or mains reset).



The LED module's temperature is only measured if the output is active (lamp is on).

The allowed NTC resistor value is between 0 to 1 MΩ.

By default there are three predefined values that can be set via programming software, up to five individual values can be added.

Following error feedback shall given in case the LED driver detects any NTC related error:

- 0.5 s off -> 0.5 s on, by 1 time flashing
- 0.2 s off -> 0.2 s on, by 2 times flashing
- 0.5 s off -> 0.5 s on, by 1 time flashing

7. Protective features

7.1 Short-circuit behaviour

In case of a short circuit on the secondary side (LED) the output current remains constant. After elimination of the short-circuit fault the LED driver will recover automatically.

7.2 No-load operation

The LED driver works in burst working mode to provide a constant output voltage regulation which allows the application to be able to work safely when LED string opens due to a failure.

7.3 Overload protection

If the maximum load is exceeded by a defined internal limit, the LED driver will protect itself and LED may flicker. After elimination of the overload, the nominal operation is restored automatically.

7.4 Overtemperature protection

The LED driver is protected against temporary thermal overheating. When $t_c = 100\text{ °C}$ the output current decreases with the increase of temperature.

When $t_c = 120\text{ °C}$ the output current decreases to min. dimming level.

The temperature protection is activated typically at 10 °C above t_c max.

8. Miscellaneous

8.1 Insulation and electric strength testing of luminaires

Electronic devices can be damaged by high voltage. This has to be considered during the routine testing of the luminaires in production.

According to UL 8750 (informative only!) each luminaire should be submitted to an insulation test with 500 V_{DC}. The dielectric withstand test equipment shall employ a transformer of 500-VA or larger capacity and have a variable output voltage that is essentially sinusoidal or continuous direct current. The applied potential is to be increased from zero at a substantially uniform rate until the required test level is reached, and is to be held at that level for 1 minute.

As an alternative, UL8750 (informative only!) describes a test of the electrical strength with 2V AC + 1000V (or 1.414 x V DC). To avoid damage to the electronic devices this test must not be conducted.

8.2 Conditions of use and storage

Humidity: 5 % up to max. 85 %,
not condensed
(max. 56 days/year at 85 %)

Storage temperature: -40 °C up to max. +80 °C

The devices have to be acclimatised to the specified temperature range (ta) before they can be operated.

8.3 Maximum number of switching cycles

All LED driver are tested with 50,000 switching cycles.

8.4 Additional information

Additional technical information at www.tridonic.com → Technical Data

Lifetime declarations are informative and represent no warranty claim.
No warranty if device was opened.

X-ON Electronics

Largest Supplier of Electrical and Electronic Components

Click to view similar products for [LED Power Supplies](#) category:

Click to view products by [Tridonic](#) manufacturer:

Other Similar products are found below :

[ESS015W-1000-12](#) [PDA-WIFI](#) [PIFC-K250F](#) [PITB-K222A](#) [ALD-514012PJ134](#) [LB240S24KH](#) [LMH020-SPLC-0000-0000001](#) [79534](#) [79535](#)
[EUG-200S210DT](#) [ESS030W-1050-21](#) [ESS030W-0900-32](#) [BPOXL 4-12-035](#) [ESS010W-0350-24](#) [ESM060W-1400-42](#) [PDA080B-1A0G](#)
[PDA150B-S1A5G](#) [SLM140W-1.05-130-ZA](#) [ESS015W-0700-18](#) [EUD-150S350DVA](#) [LWA320-C420-ARK-B](#) [HVG-240-48AB](#) [HVG-320-36AB](#) [HVG-320-54AB](#) [ELG-240-C1400AB](#) [EUK-150S105DV](#) [BXCS-12Z-N2P-B1-A](#) [BXPR-WN-01-A](#) [BXCS-12D-N2P-01-A](#) [BXCS-12W-N2P-01-A](#) [LC 50W 200-350ML 170V FLEXC LP SNC4](#) [LC 25W 200-350ML 70V FLEXC LP SNC4](#) [LC 35W 200-350ML 121V FLEXC LP SNC4](#) [LC 10W 250MA FIXC SC SNC2](#) [LC 35W 800MA FIXC SR ADV2](#) [LC 38W 900MA FIXC SR ADV2](#) [LC 34W 800MA FIXC SC ADV2](#) [LC 44W 1050MA FIXC SC ADV2](#) [LC 38W 900MA 42V FIXC SRL ADV2](#) [HVG-320-48AB](#) [CNB50W-1200-42-CAS](#) [CNB30W-0600-42-CAS](#) [LCI 100W 1400MA TEC C](#) [LCI 100W 2100MA TEC C](#) [LCI 150W 1750MA TEC C](#) [LCI 150W 2100MA TEC C](#) [87500284](#) [87500447](#) [LC 50W 1200MA FIXC SR SNC](#) [87500554](#)