

**Driver LC 50/60W 1200/700/1400mA fixC SR SNC**  
essence series

### Product description

- Independent fixed output LED driver
- Constant current LED driver
- For luminaires of protection class I and protection class II
- Temperature protection as per EN 61347-2-13 C5e
- Output current 1,200, 700 or 1,400 mA
- Max. output power 50 or 60 W
- Nominal lifetime up to 50,000 h
- 5 years guarantee (conditions at [www.tridonic.com](http://www.tridonic.com))



### Housing properties

- Casing: polycarbonat, white
- Type of protection IP20

### Functions

- Overtemperature protection
- Overload protection
- Short-circuit protection
- No-load protection



**Standards**, page 3

**Wiring diagrams and installation examples**, page 4



IP20 SELV

### Driver LC 50/60W 1200/700/1400mA fixC SR SNC essence series

#### Technical data

Rated supply voltage	220 – 240 V
AC voltage range	198 – 264 V
Mains frequency	50 / 60 Hz
Overvoltage protection	320 V AC, 1 h
THD (at 230 V, 50 Hz, full load)	< 20 %
Output current tolerance <sup>®</sup>	± 7.5 %
Typ. current ripple (at 230 V, 50 Hz, full load)	± 30 %
Starting time (at 230 V, 50 Hz, full load)	≤ 0.5 s
Turn off time (at 230 V, 50 Hz, full load)	≤ 0.2 s
Hold on time at power failure (output)	0 s
Ambient temperature $t_a$	-20 ... +50 °C
Ambient temperature $t_a$ (at lifetime 50,000 h)	40 °C
Storage temperature $t_s$	-40 ... +80 °C
Lifetime	up to 50,000 h
Guarantee (conditions at <a href="http://www.tridonic.com">www.tridonic.com</a> )	5 years
Dimensions L x W x H	159.4 x 82 x 34 mm

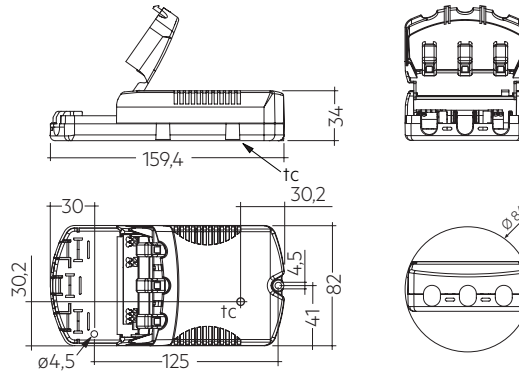

#### Ordering data

Type <sup>®</sup>	Article number	Packaging, carton	Packaging, low volume	Packaging, high volume	Weight per pc.
<b>LC 50W 1200mA fixC SR SNC</b>	<b>87500553</b>	30 pc(s).	300 pc(s).	1,200 pc(s).	0.196 kg
<b>LC 60W 700mA fixC SR SNC</b>	<b>87500554</b>	30 pc(s).	300 pc(s).	1,200 pc(s).	0.193 kg
<b>LC 60W 1400mA fixC SR SNC</b>	<b>87500555</b>	30 pc(s).	300 pc(s).	1,200 pc(s).	0.195 kg

#### Specific technical data

Type	Output current <sup>®</sup>	Input current (at 230 V, 50 Hz, full load)	Max. input power	Typ. power consumption (at 230 V, 50 Hz, full load)	Output power range	$\lambda$ at full load <sup>®</sup>	Efficiency at full load <sup>®</sup>	$\lambda$ at min. load <sup>®</sup>	Efficiency at min. load <sup>®</sup>	Min. forward voltage	Max. forward voltage	Max. output voltage	Max. output peak current at full load <sup>®</sup>	Max. output peak current at min. load <sup>®</sup>	Max. casing temperature $t_c$
<b>LC 50W 1200mA fixC SR SNC</b>	1,200 mA	260 mA	58 W	55.5 W	36.0 – 51.6 W	0.96	90 %	0.92C	88 %	30 V	43 V	55 V	1,700 mA	1,800 mA	90 °C
<b>LC 60W 700mA fixC SR SNC</b>	700 mA	290 mA	68 W	60.0 W	42.0 – 59.5 W	0.96	91 %	0.94C	89 %	60 V	85 V	100 V	1,000 mA	1,100 mA	90 °C
<b>LC 60W 1400mA fixC SR SNC</b>	1,400 mA	300 mA	68 W	66.5 W	42.0 – 60.2 W	0.96	90 %	0.94C	88 %	30 V	43 V	55 V	2,000 mA	2,100 mA	90 °C

<sup>®</sup> Test result at 230 V, 50 Hz.

<sup>®</sup> The trend between min. and full load is linear.

<sup>®</sup> Output current is mean value.

**Standards**

- EN 55015
- EN 61000-3-2
- EN 61000-3-3
- EN 61347-1
- EN 61347-2-13
- EN 61547

**Overload protection**

If the maximum load is exceeded by a defined internal limit, the LED driver will protect itself and LED may flicker. After elimination of the overload, the nominal operation is restored automatically.

**Overtemperature protection**

The LED driver is protected against temporary thermal overheating. If the temperature limit is exceeded, the output current is reduced to limit  $t_c$  at a certain level.

The temperature protection is activated typically at 10 °C above  $t_c$  max.

**Short-circuit behaviour**

In case of a short circuit on the secondary side (LED) the LED driver switches into hic-cup mode. After elimination of the short-circuit fault the LED driver will recover automatically.

**No-load operation**

The LED driver works in burst working mode to provide a constant output voltage regulation which allows the application to be able to work safely when LED string opens due to a failure.

**Installation instructions**

The LED module and all contact points within the wiring must be sufficiently insulated against 3 kV surge voltage.

Air and creepage distance must be maintained.

**Replace LED module**

1. Mains off
2. Remove LED module
3. Wait for 10 seconds
4. Connect LED module again

Hot plug-in or secondary switching of LEDs is not permitted and may cause a very high current to the LEDs.

**Expected lifetime**

Type	$t_a$	40 °C	50 °C	60 °C
<b>LC 50W 1200mA fixC SR SNC</b>	$t_c$	80 °C	90 °C	x
	Lifetime	50,000 h	30,000 h	x
<b>LC 60W 700mA fixC SR SNC</b>	$t_c$	80 °C	90 °C	x
	Lifetime	50,000 h	30,000 h	x
<b>LC 60W 1400mA fixC SR SNC</b>	$t_c$	80 °C	90 °C	x
	Lifetime	50,000 h	30,000 h	x

The LED drivers are designed for a lifetime stated above under reference conditions and with a failure probability of less than 10 %.

The relation of  $t_c$  to  $t_a$  temperature depends also on the luminaire design. If the measured  $t_c$  temperature is approx. 5 K below  $t_c$  max.,  $t_a$  temperature should be checked and eventually critical components (e.g. ELCAP) measured. Detailed information on request.

**Fixing conditions**

Dry, acidfree, oilfree, fatfree. It is not allowed to exceed the maximum ambient temperature ( $t_a$ ) stated on the device. Minimum distances stated below are recommendations and depend on the actual luminaire. Is not suitable for fixing in corner.

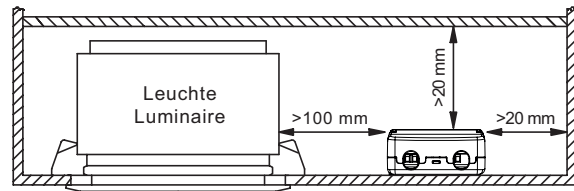

**Glow-wire test**

according to EN 61347-1 with increased temperature of 850 °C passed.

**Mounting of device**

Max. torque for fixing: 0.5 Nm/M4

**Conditions of use and storage**

Humidity: 5% up to max. 85%,  
not condensed  
(max. 56 days/year at 85%)

Storage temperature: -40 °C up to max. +80 °C

The devices have to be within the specified temperature range ( $t_a$ ) before they can be operated.

**Maximum loading of automatic circuit breakers in relation to inrush current**

Automatic circuit breaker type	C10	C13	C16	C20	B10	B13	B16	B20	Inrush current
Installation Ø	1.5 mm <sup>2</sup>	1.5 mm <sup>2</sup>	1.5 mm <sup>2</sup>	2.5 mm <sup>2</sup>	1.5 mm <sup>2</sup>	1.5 mm <sup>2</sup>	1.5 mm <sup>2</sup>	2.5 mm <sup>2</sup>	I <sub>max</sub> Time
<b>LC 50W 1200mA fixC SR SNC</b>	32	45	60	80	32	45	60	80	10 A 50 µs
<b>LC 60W 700mA fixC SR SNC</b>	25	35	45	55	25	35	45	55	12 A 50 µs
<b>LC 60W 1400mA fixC SR SNC</b>	25	35	45	55	25	35	45	55	12 A 50 µs

These are max. values calculated out of continuous current running the device on full load. There is no limitation due to inrush current. If load is smaller than full load for calculation only continuous current has to be considered.

**Harmonic distortion in the mains supply (at 230 V / 50 Hz and full load) in %**

	THD	3.	5.	7.	9.	11.
<b>LC 50W 1200mA fixC SR SNC</b>	< 20	< 12	< 4	< 2	< 2	< 2
<b>LC 60W 700mA fixC SR SNC</b>	< 20	< 12	< 4	< 2	< 2	< 2
<b>LC 60W 1400mA fixC SR SNC</b>	< 20	< 12	< 4	< 2	< 2	< 2

**Wiring diagram**

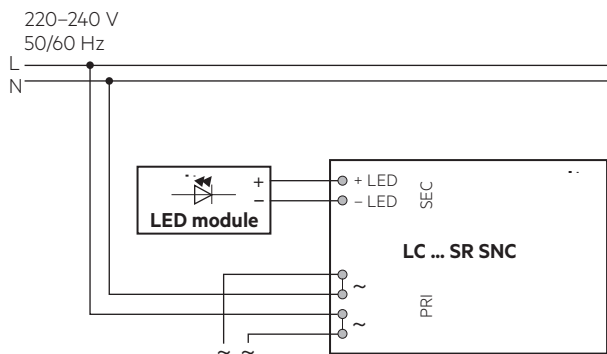

Device with loop through wiring function.

**Insulation and electric strength testing of luminaires**

Electronic devices can be damaged by high voltage. This has to be considered during the routine testing of the luminaires in production.

According to IEC 60598-1 Annex Q (informative only!) or ENEC 303-Annex A, each luminaire should be submitted to an insulation test with 500 V<sub>DC</sub> for 1 second. This test voltage should be connected between the interconnected phase and neutral terminals and the earth terminal. The insulation resistance must be at least 2 MΩ.

As an alternative, IEC 60598-1 Annex Q describes a test of the electrical strength with 1500 V<sub>AC</sub> (or 1.414 x 1500 V<sub>DC</sub>). To avoid damage to the electronic devices this test must not be conducted.

**Conditions of use**

The LED driver is declared as inbuilt LED controlgear, meaning it is intended to be used within a luminaire enclosure. If the product is used outside a luminaire, the installation must provide suitable protection for people and environment (e.g. in illuminated ceilings).

**Wiring type and cross section**

The wiring can be in stranded wires with ferrules or solid. For perfect function of the cage clamp terminals the strip length should be 4 – 5 mm for the input terminal. The max. torque at the clamping screw (M3) is 0.2 Nm. Use one wire for each terminal connector only. Use each strain relief channel for one cable only.

**Input / Output terminal**

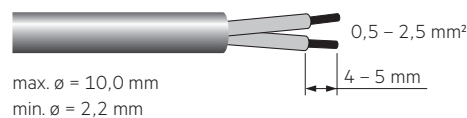

**Wiring instructions**

The secondary leads should be separated from the mains connections and wiring for good EMC performance. The maximum lead length on secondary side is 2 m. For a good EMC performance keep the LED wiring as short as possible.

**Wiring guidelines**

- All connections must be kept as short as possible to ensure good EMI behaviour.
- Mains leads should be kept apart from LED control gear and other leads (ideally 5 – 10 cm distance)
- Max. length of output wires is 2 m.
- To comply with the EMC regulations run the secondary wires (LED module) in parallel.
- Secondary switching is not permitted.
- Incorrect wiring can damage LED modules.
- Through wiring of mains is for connecting additional LED driver only. Max. permanent current of 16 A may not be exceeded.
- To avoid the damage of the Driver, the wiring must be protected against short circuits to earth (sharp edged metal parts, metal cable clips, louver, etc.).

**Maximum number of switching cycles**

All LED driver are tested with 50,000 switching cycles.

**Additional information**

Additional technical information at [www.tridonic.com](http://www.tridonic.com) → Technical Data

Lifetime declarations are informative and represent no warranty claim. No warranty if device was opened.

**Diagrams LC 50W 1200mA fixC SR SNC**

Efficiency vs load

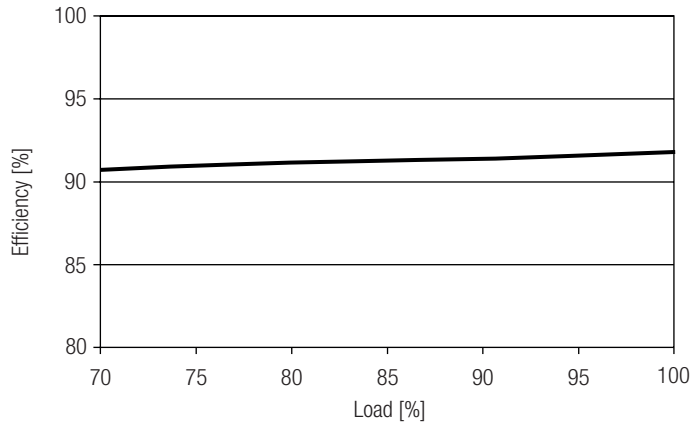

Power factor vs load

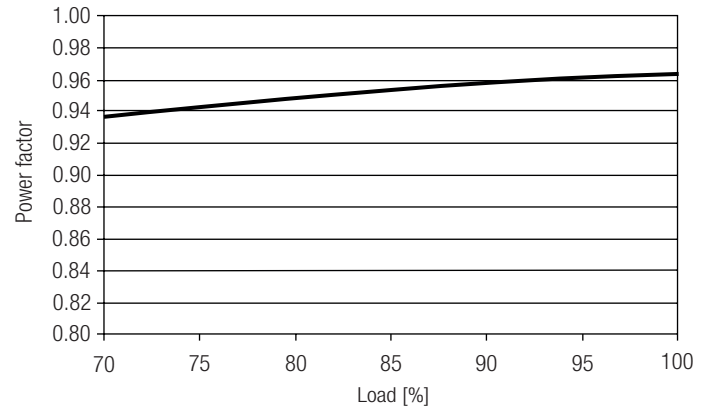

Input power vs load

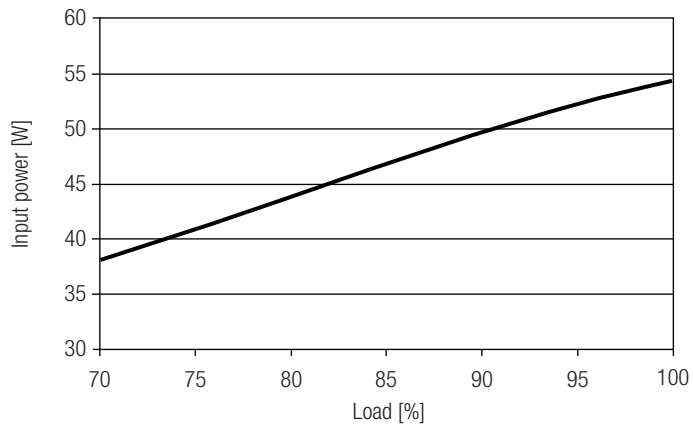

Input current vs load

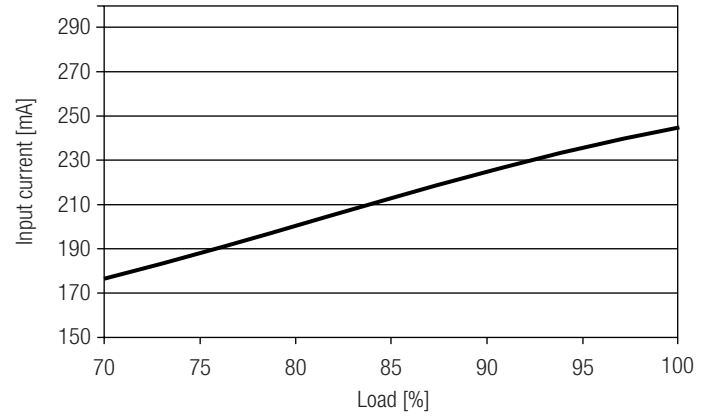

THD vs load

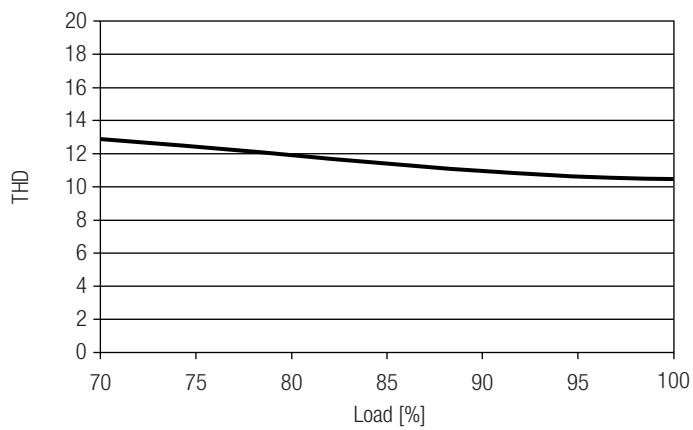

**Diagrams LC 60W 700mA fixC SR SNC**

Efficiency vs load

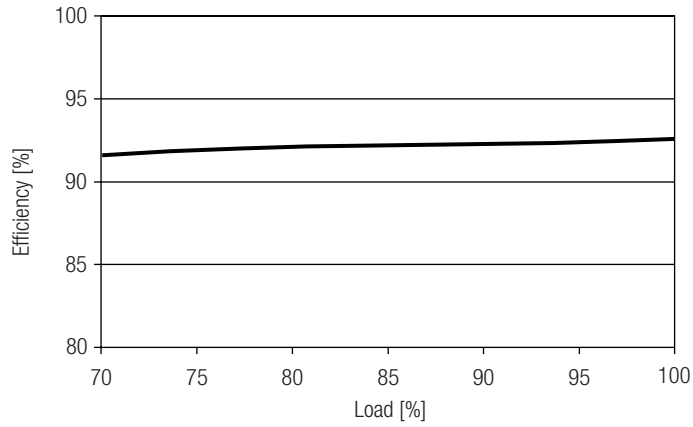

Power factor vs load

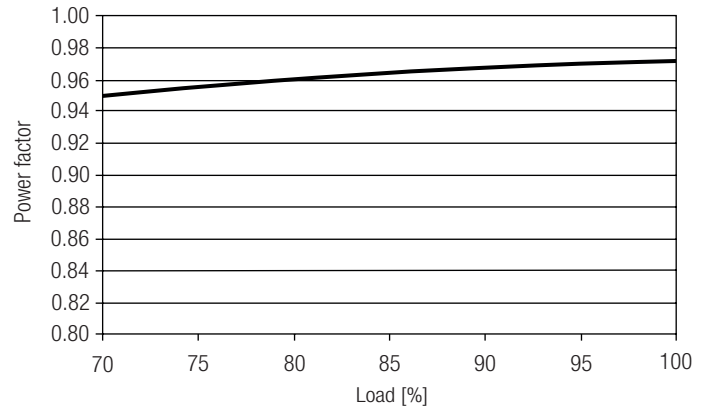

Input power vs load

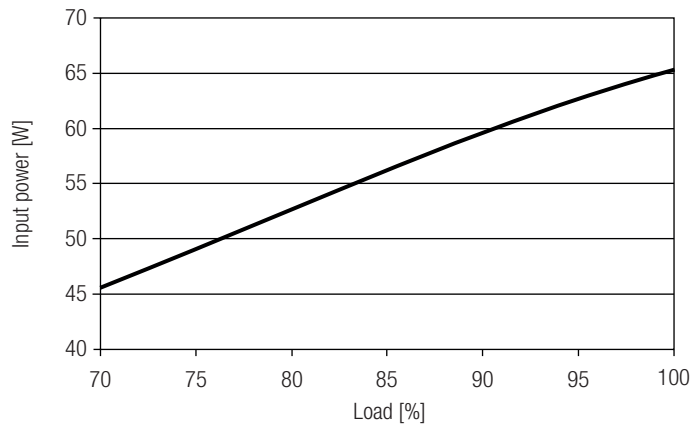

Input current vs load

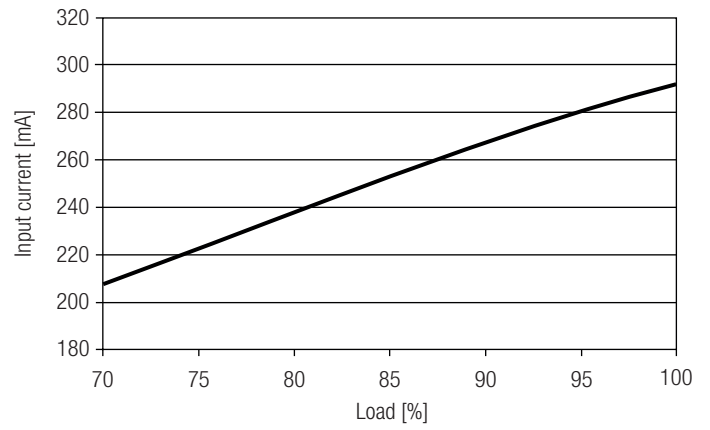

THD vs load

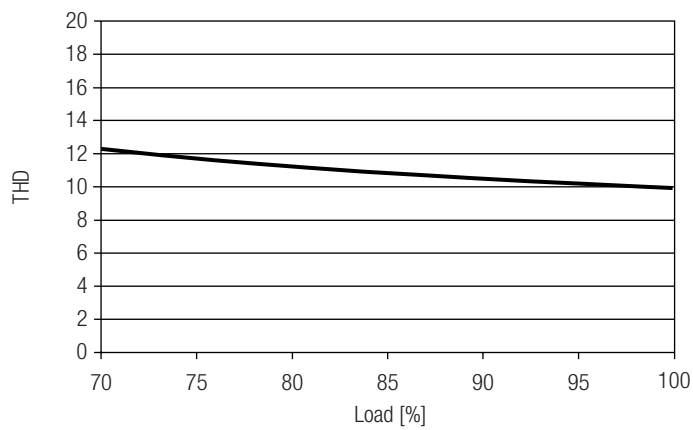

**Diagrams LC 60W 1400mA fixC SR SNC**

Efficiency vs load

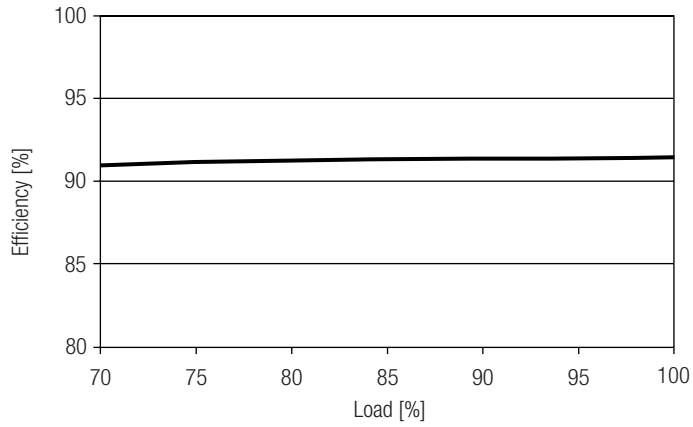

Power factor vs load

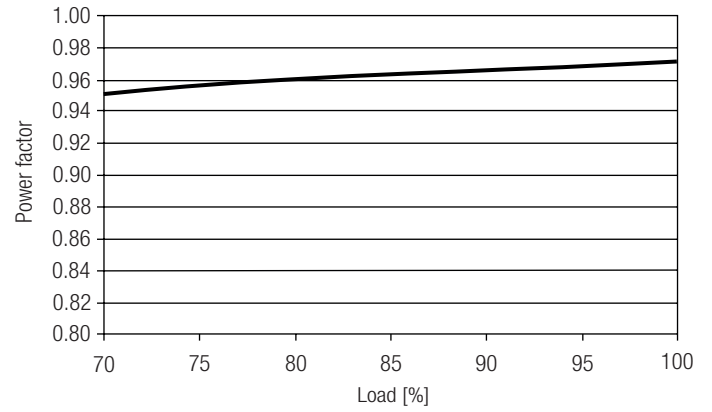

Input power vs load

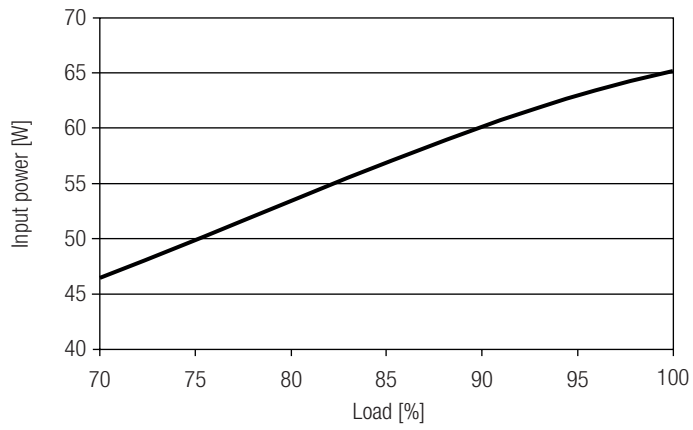

Input current vs load

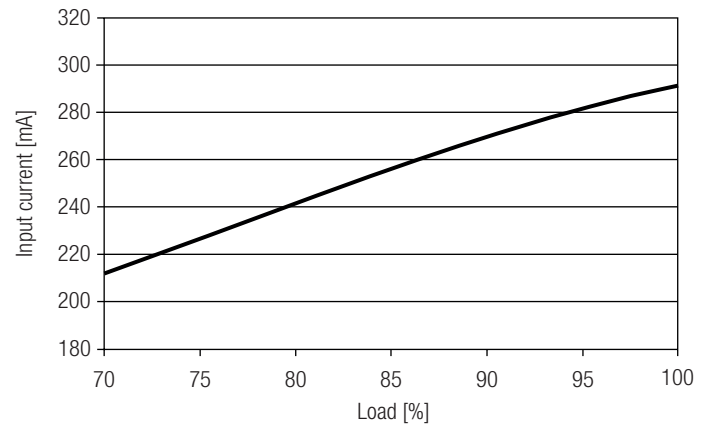

THD vs load

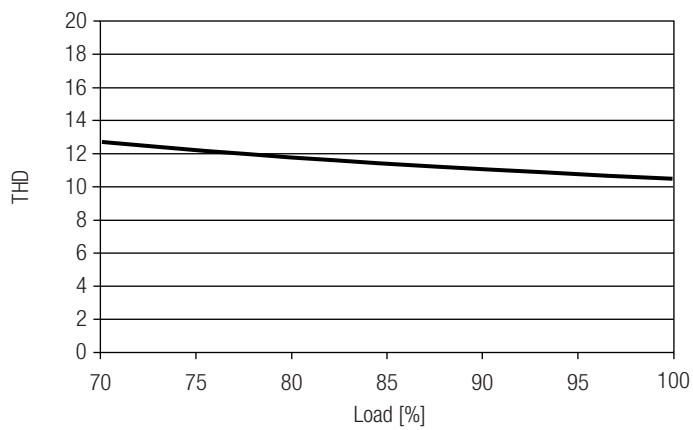

## X-ON Electronics

Largest Supplier of Electrical and Electronic Components

*Click to view similar products for [LED Power Supplies](#) category:*

*Click to view products by [Tridonic](#) manufacturer:*

Other Similar products are found below :

[ESS015W-1000-12](#) [PDA-WIFI](#) [PIFC-K250F](#) [PITB-K222A](#) [ALD-514012PJ134](#) [LB240S24KH](#) [LMH020-SPLC-0000-0000001](#) [79534](#) [79535](#)  
[EUG-200S210DT](#) [ESS030W-1050-21](#) [ESS030W-0900-32](#) [BPOXL 4-12-035](#) [ESS010W-0350-24](#) [ESM060W-1400-42](#) [PDA080B-1A0G](#)  
[PDA150B-S1A5G](#) [SLM140W-1.05-130-ZA](#) [ESS015W-0700-18](#) [EUD-150S350DVA](#) [LWA320-C420-ARK-B](#) [HVG-240-48AB](#) [HVG-320-](#)  
[36AB](#) [HVG-320-54AB](#) [ELG-240-C1400AB](#) [EUK-150S105DV](#) [BXCS-12Z-N2P-B1-A](#) [BXPR-WN-01-A](#) [BXCS-12D-N2P-01-A](#) [BXCS-](#)  
[12W-N2P-01-A](#) [LC 50W 200-350ML 170V FLEXC LP SNC4](#) [LC 25W 200-350ML 70V FLEXC LP SNC4](#) [LC 35W 200-350ML 121V](#)  
[FLEXC LP SNC4](#) [LC 10W 250MA FIXC SC SNC2](#) [LC 35W 800MA FIXC SR ADV2](#) [LC 38W 900MA FIXC SR ADV2](#) [LC 34W 800MA](#)  
[FIXC SC ADV2](#) [LC 44W 1050MA FIXC SC ADV2](#) [LC 38W 900MA 42V FIXC SRL ADV2](#) [HVG-320-48AB](#) [CNB50W-1200-42-CAS](#)  
[CNB30W-0600-42-CAS](#) [LCI 100W 1400MA TEC C](#) [LCI 100W 2100MA TEC C](#) [LCI 150W 1750MA TEC C](#) [LCI 150W 2100MA TEC C](#)  
[87500284](#) [87500447](#) [LC 50W 1200MA FIXC SR SNC](#) [87500554](#)