

Driver LC 15/20/25W 350/500/700/600mA fixC C SNC
essence series

Product description

- Fixed output built-in LED driver
- Constant current LED driver
- For luminaires of protection class I and protection class II
- Temperature protection as per EN 61347-2-13 C5e
- KC certificate for LC 15W 350mA fixC C SNC, LC 20W 500mA fixC C SNC and LC 20W 700mA fixC C SNC
- Output current 350, 500, 700 or 600 mA
- Max. output power 15, 20 or 25 W
- Nominal lifetime up to 50,000 h
- 5 years guarantee (conditions at www.tridonic.com)



Housing properties

- Casing: polycarbonat, white
- Type of protection IP20

Functions

- Overtemperature protection
- Overload protection
- Short-circuit protection
- No-load protection
- Surge protection voltage 1 kV (L to N)
- Surge protection voltage 2 kV (L/N to earth)



Standards, page 3

Wiring diagrams and installation examples, page 4



IP20 SELV 

RoHS

Driver LC 15/20/25W 350/500/700/600mA fixC C SNC

essence series

Technical data

Rated supply voltage	220 – 240 V
AC voltage range	198 – 264 V
Mains frequency	50 / 60 Hz
Oversvoltage protection	320 V AC, 1 h
THD (at 230 V, 50 Hz, full load)	< 20 %
Output current tolerance [®]	± 75 %
Typ. current ripple (at 230 V, 50 Hz, full load)	± 30 %
Starting time (at 230 V, 50 Hz, full load)	≤ 0.5 s
Turn off time (at 230 V, 50 Hz, full load)	≤ 0.5 s
Hold on time at power failure (output)	0 s
Ambient temperature ta	-20 ... +50 °C
Ambient temperature ta (at lifetime 50,000 h)	40 °C
Storage temperature ts	-40 ... +80 °C
Lifetime	up to 50,000 h
Guarantee (conditions at www.tridonic.com)	5 years
Dimensions L x W x H	93 x 58 x 26.2 mm

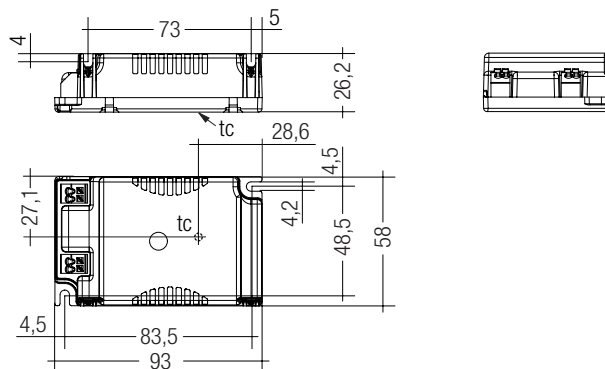

LC 15/20W 350/500/700mA fixC C SNC

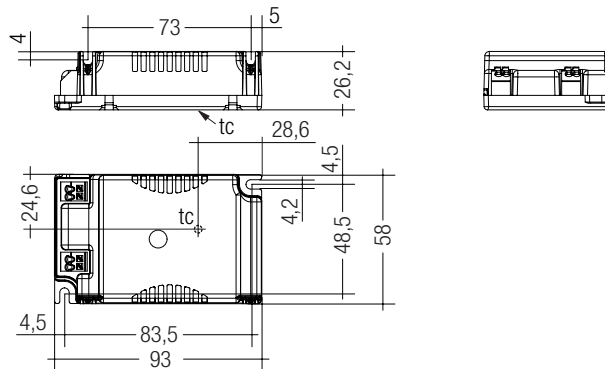

LC 25W 600mA fixC C SNC

Ordering data

Type [®]	Article number	Packaging, carton	Packaging, low volume	Packaging, high volume	Weight per pc.
LC 15W 350mA fixC C SNC	87500565	50 pc(s).	700 pc(s).	4,200 pc(s).	0.075 kg
LC 20W 500mA fixC C SNC	87500566	50 pc(s).	700 pc(s).	4,200 pc(s).	0.075 kg
LC 20W 700mA fixC C SNC	87500567	50 pc(s).	700 pc(s).	4,200 pc(s).	0.075 kg
LC 25W 600mA fixC C SNC	87500575	50 pc(s).	700 pc(s).	4,200 pc(s).	0.079 kg

Specific technical data

Type	Output current [®]	Input current (at 230 V, 50 Hz, full load)	Max. input power	Typ. power consumption (at 230 V, 50 Hz, full load)	Output power range	λ at full load [®]	Efficiency at full load [®]	λ at min. load [®]	Efficiency at min. load [®]	Min. forward voltage	Max. forward voltage	Max. output voltage	Max. output peak current at full load [®]	Max. output peak current at min. load [®]	Max. casing temperature tc
LC 15W 350mA fixC C SNC	350 mA	83 mA	18.0 W	17.0 W	10.5 – 15.0 W	0.92C	87.5 %	0.87C	86.5 %	30 V	43.0 V	56 V	490 mA	560 mA	70 °C
LC 20W 500mA fixC C SNC	500 mA	112 mA	25.0 W	22.5 W	15.0 – 21.5 W	0.95	87.5 %	0.92C	87.0 %	30 V	43.0 V	56 V	700 mA	800 mA	75 °C
LC 20W 700mA fixC C SNC	700 mA	107 mA	24.0 W	23.0 W	14.0 – 20.0 W	0.94C	86.0 %	0.90C	85.0 %	20 V	28.5 V	40 V	980 mA	1,120 mA	75 °C
LC 25W 600mA fixC C SNC	600 mA	134 mA	30.0 W	28.0 W	18.0 – 26.0 W	0.95	88.5 %	0.91C	87.5 %	30 V	43.0 V	56 V	840 mA	960 mA	85 °C

[®] Test result at 230 V, 50 Hz.

[®] The trend between min. and full load is linear.

[®] Output current is mean value.

Standards

EN 55015
EN 61000-3-2
EN 61000-3-3
EN 61347-1
EN 61347-2-13
EN 61547

Overload protection

If the maximum load is exceeded by a defined internal limit, the LED driver will protect itself and LED may flicker. After elimination of the overload, the nominal operation is restored automatically.

Overtemperature protection

The LED driver is protected against temporary thermal overheating. If the temperature limit is exceeded, the output current is reduced to limit t_c at a certain level.

The temperature protection is activated typically at 10 °C above t_c max.

Short-circuit behaviour

In case of a short circuit on the secondary side (LED) the LED driver switches into hic-cup mode. After elimination of the short-circuit fault the LED driver will recover automatically.

No-load operation

The LED driver works in burst working mode to provide a constant output voltage regulation which allows the application to be able to work safely when LED string opens due to a failure.

Expected lifetime

Type	t_a	40 °C	50 °C	60 °C
LC 15W 350mA fixC C SNC	t_c	60 °C	70 °C	x
	Lifetime	50,000h	30,000h	x
LC 20W 500/700mA fixC C SNC	t_c	65 °C	75 °C	x
	Lifetime	50,000h	30,000h	x
LC 25W 600mA fixC C SNC	t_c	75 °C	85 °C	x
	Lifetime	50,000h	30,000h	x

The LED drivers are designed for a lifetime stated above under reference conditions and with a failure probability of less than 10 %.

Lifetime declarations are informative and represent no warranty claim.

The relation of t_c to t_a temperature depends also on the luminaire design. If the measured t_c temperature is approx. 5 K below t_c max., t_a temperature should be checked and eventually critical components (e.g. ELCAP) measured. Detailed information on request.

Maximum loading of automatic circuit breakers in relation to inrush current

Automatic circuit breaker type	C10	C13	C16	C20	B10	B13	B16	B20	Inrush current	
Installation Ø	1.5 mm ²	1.5 mm ²	1.5 mm ²	2.5 mm ²	1.5 mm ²	1.5 mm ²	1.5 mm ²	2.5 mm ²	I_{max}	Time
LC 15W 350mA fixC C SNC	105	140	170	215	105	140	170	215	8 A	80 µs
LC 20W 500mA fixC C SNC	75	95	120	150	75	95	120	150	8 A	80 µs
LC 20W 700mA fixC C SNC	80	100	125	160	80	100	125	160	8 A	80 µs
LC 25W 600mA fixC C SNC	60	80	100	125	60	80	100	125	8 A	80 µs

These are max. values calculated out of continuous current running the device on full load.

There is no limitation due to inrush current.

If load is smaller than full load for calculation only continuous current has to be considered.

Installation instructions

The LED module and all contact points within the wiring must be sufficiently insulated against 3 kV surge voltage.

Air and creepage distance must be maintained.

Replace LED module

1. Mains off
2. Remove LED module
3. Wait for 10 seconds
4. Connect LED module again

Hot plug-in or secondary switching of LEDs is not permitted and may cause a very high current to the LEDs.

Glow-wire test

according to EN 61347-1 with increased temperature of 850 °C passed.

Mounting of device

Max. torque for fixing: 0.5 Nm/M4

Conditions of use and storage

Humidity: 5 % up to max. 85 %, not condensed (max. 56 days/year at 85 %)

Storage temperature: -40 °C up to max. +80 °C

The devices have to be within the specified temperature range (t_a) before they can be operated.

Harmonic distortion in the mains supply (at 230 V / 50 Hz and full load) in %

	THD	3.	5.	7.	9.	11.
LC 15W 350mA fixC C SNC	20	10	3	3	3	2
LC 20W 500mA fixC C SNC	20	11	3	2	2	2
LC 20W 700mA fixC C SNC	20	10	2	2	2	2
LC 25W 600mA fixC C SNC	20	12	3	2	2	2

Wiring diagram

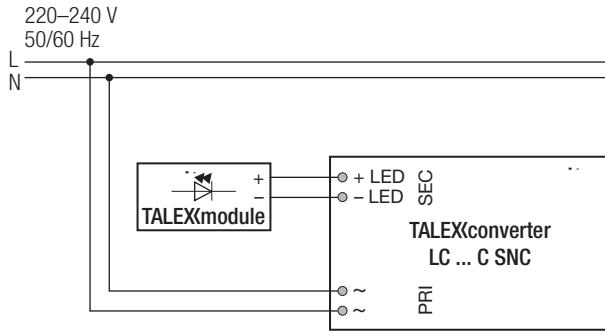

Insulation and electric strength testing of luminaires

Electronic devices can be damaged by high voltage. This has to be considered during the routine testing of the luminaires in production.

According to IEC 60598-1 Annex Q (informative only!) or ENEC 303-Annex A, each luminaire should be submitted to an insulation test with 500 V_{DC} for 1 second. This test voltage should be connected between the interconnected phase and neutral terminals and the earth terminal. The insulation resistance must be at least 2 MΩ.

As an alternative, IEC 60598-1 Annex Q describes a test of the electrical strength with 1500 V_{AC} (or 1.414 x 1500 V_{DC}). To avoid damage to the electronic devices this test must not be conducted.

Conditions of use

The LED driver is declared as inbuilt LED controlgear, meaning it is intended to be used within a luminaire enclosure. If the product is used outside a luminaire, the installation must provide suitable protection for people and environment (e.g. in illuminated ceilings).

Maximum number of switching cycles

All LED driver are tested with 50,000 switching cycles.

Additional information

Additional technical information at www.tridonic.com → Technical Data

Lifetime declarations are informative and represent no warranty claim. No warranty if device was opened.

Wiring type and cross section

The wiring can be done with a cross section of 0.5 – 1.5 mm². Strip 8.5 – 9.5 mm of insulation from the cables to ensure perfect operation of the push-wire terminals.

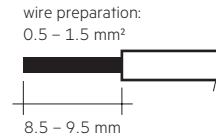

Wiring guidelines

- All connections must be kept as short as possible to ensure good EMI behaviour.
- Mains leads should be kept apart from LED driver and other leads (ideally 5 – 10 cm distance)
- Max. length of output wires is 2 m.
- Secondary switching is not permitted.
- Incorrect wiring can damage LED modules.
- To avoid the damage of the Driver, the wiring must be protected against short circuits to earth (sharp edged metal parts, metal cable clips, louver, etc.).

Release of the wiring

Press down the “push button” and remove the cable from front.

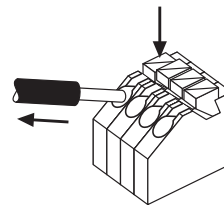

Diagrams LC 15W 350mA fixC C SNC

Efficiency vs load

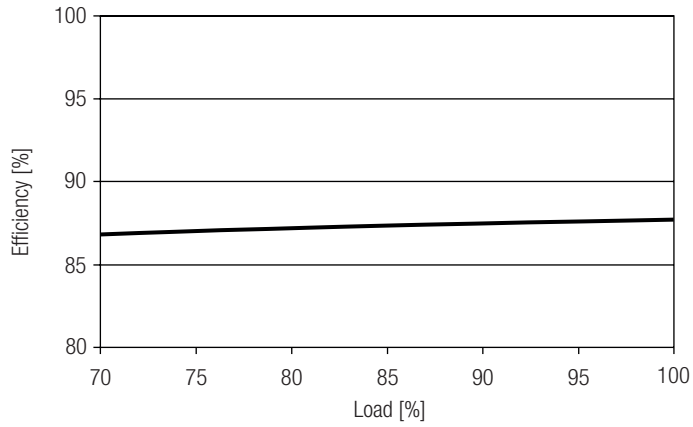

Power factor vs load

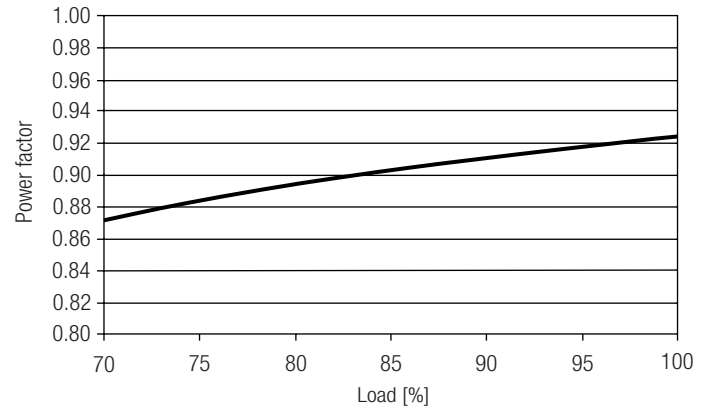

Input power vs load

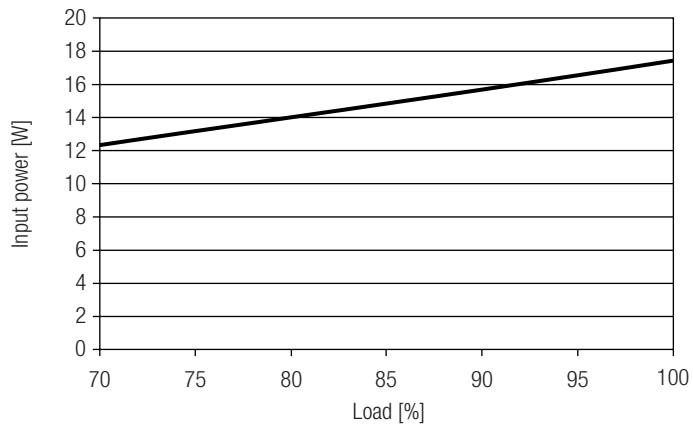

Input current vs load

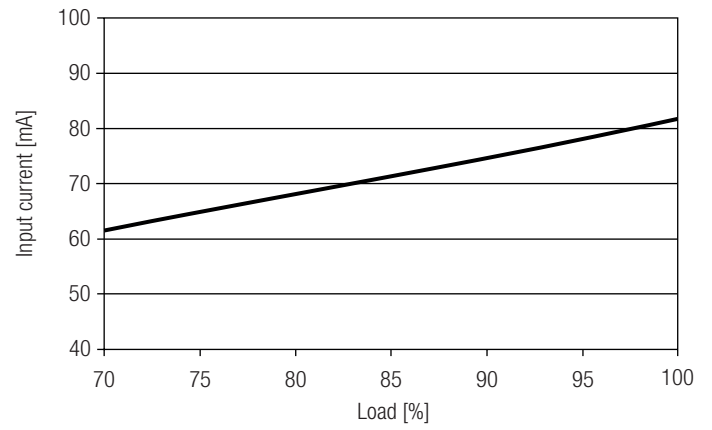

THD vs load

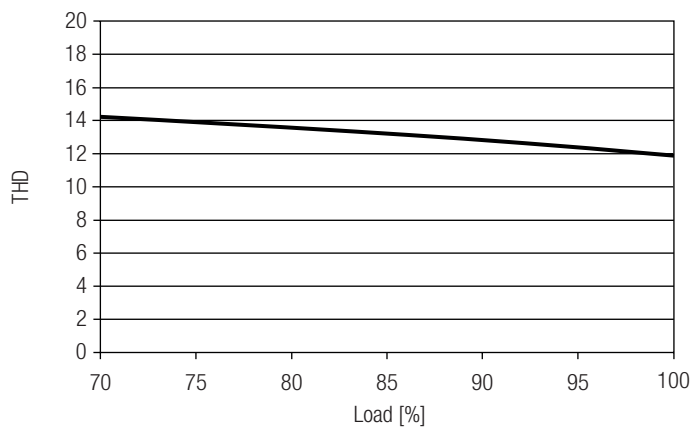

Diagrams LC 20W 500mA fixC C SNC

Efficiency vs load

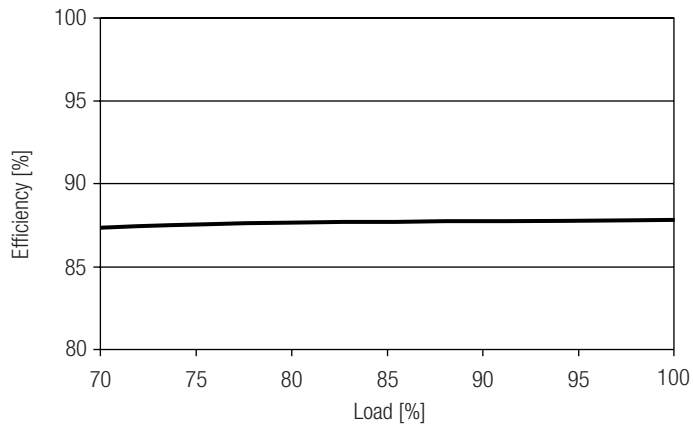

Power factor vs load

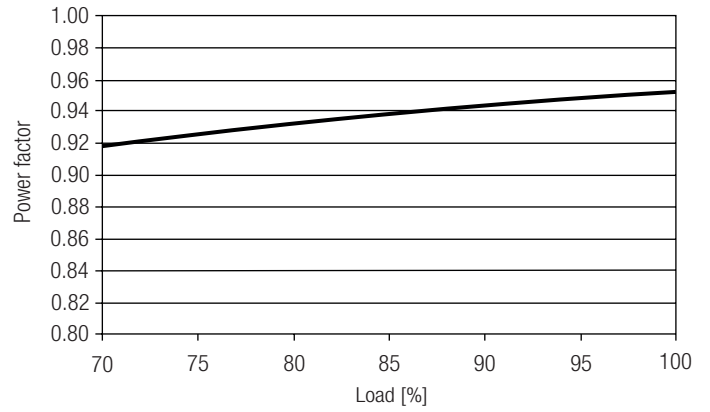

Input power vs load

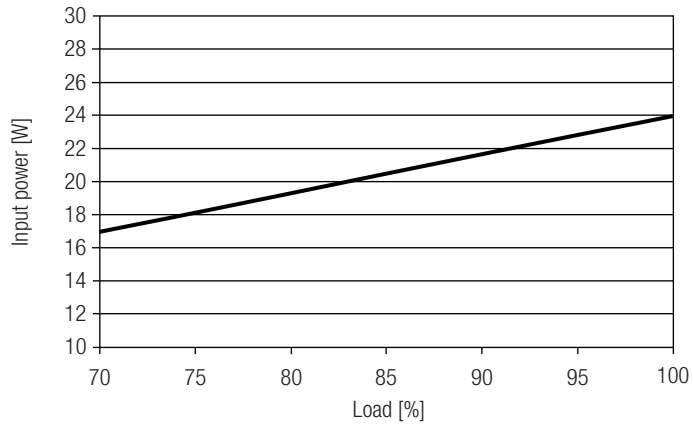

Input current vs load

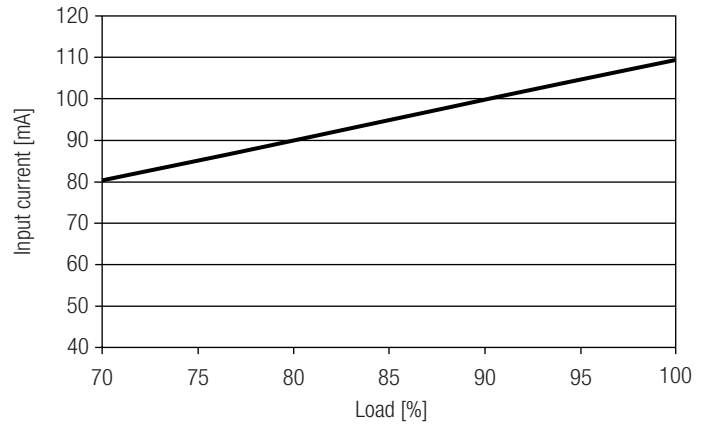

THD vs load

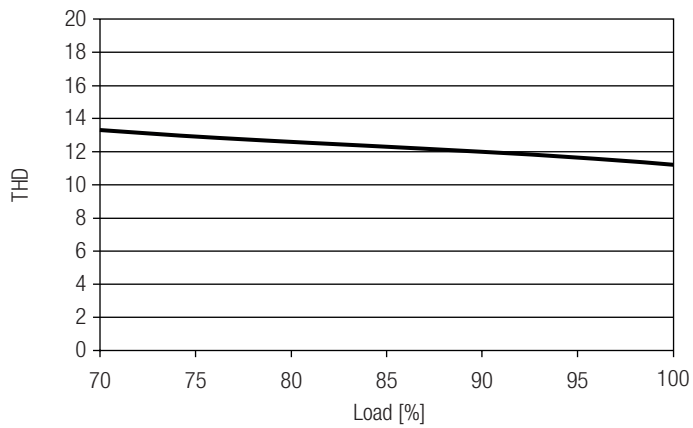

Diagrams LC 20W 700mA fixC C SNC

Efficiency vs load

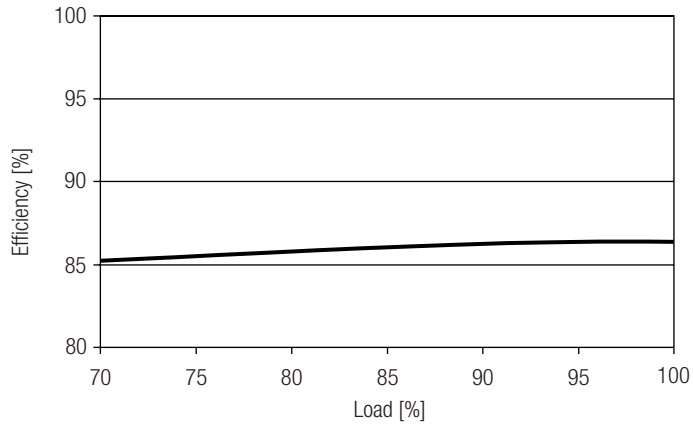

Power factor vs load

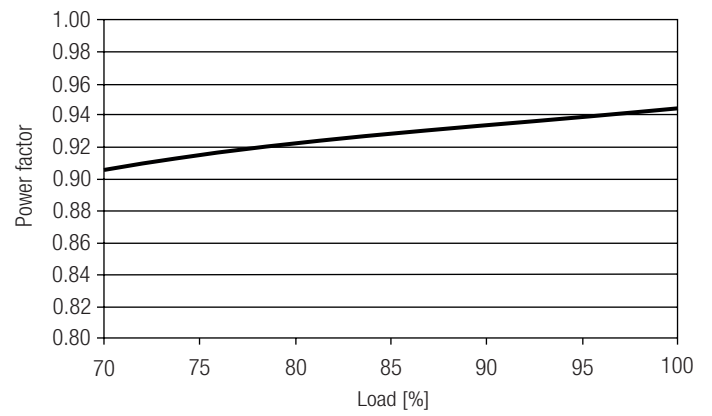

Input power vs load

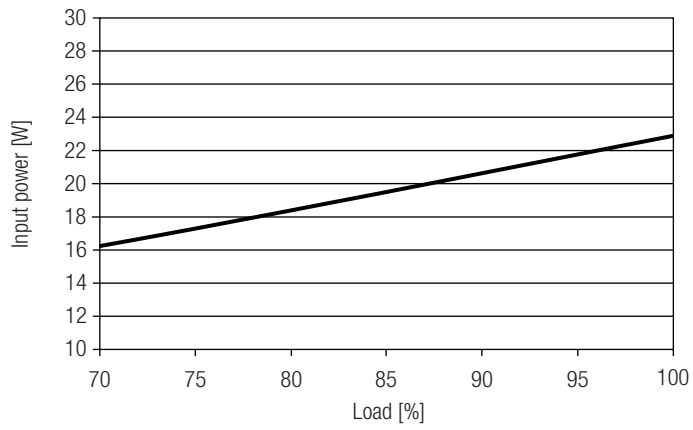

Input current vs load

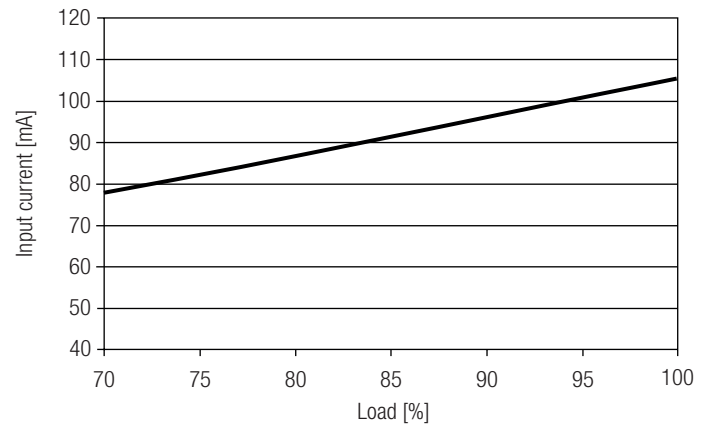

THD vs load

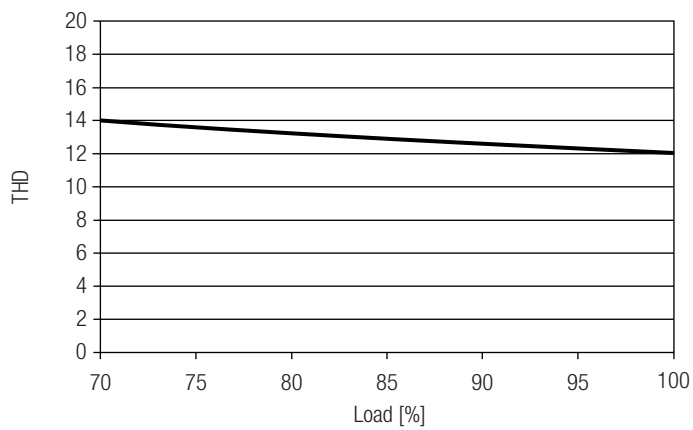

Diagrams LC 25W 600mA fixC C SNC

Efficiency vs load

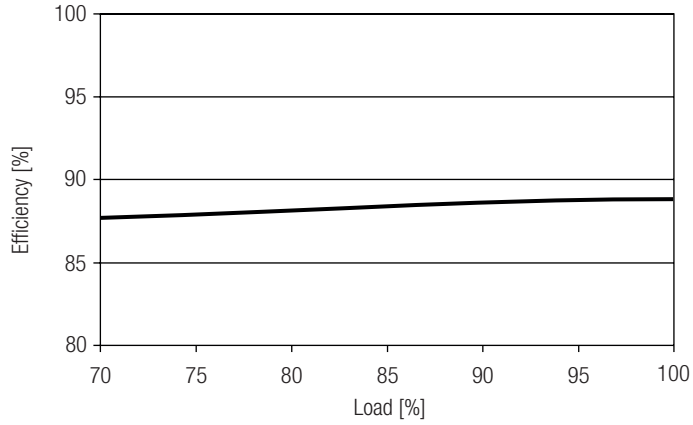

Power factor vs load

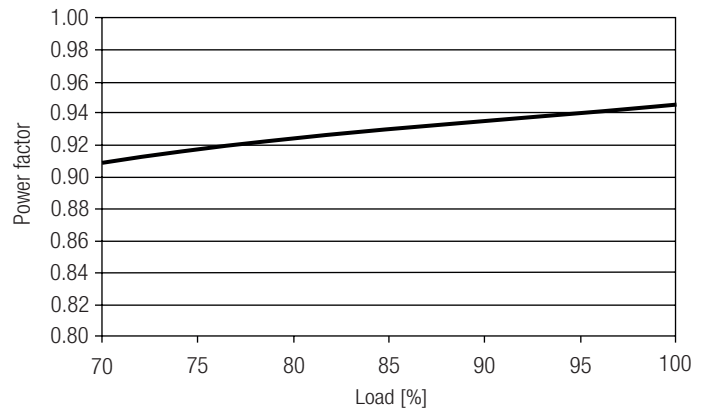

Input power vs load

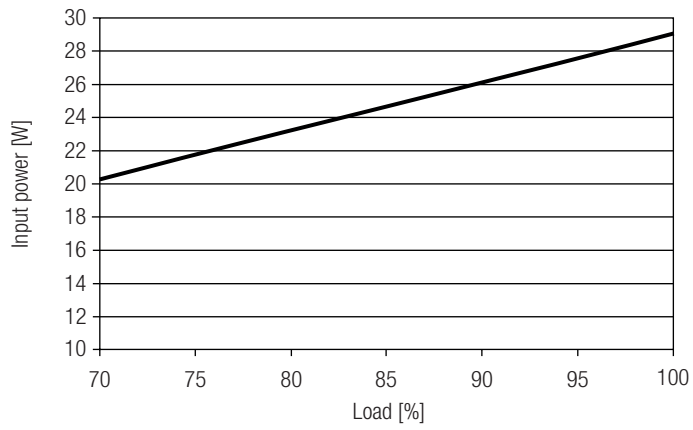

Input current vs load

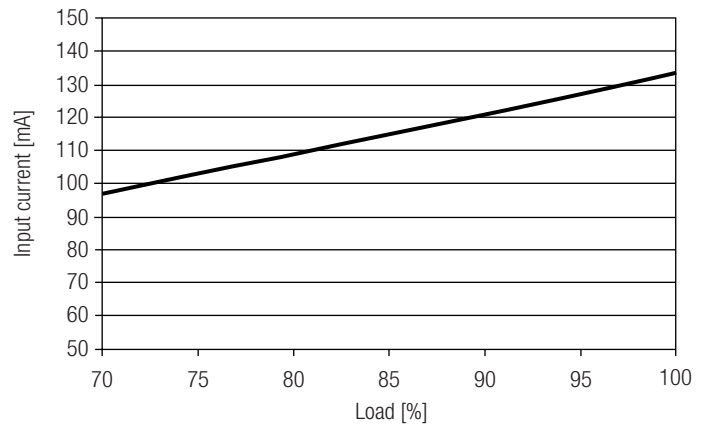

THD vs load

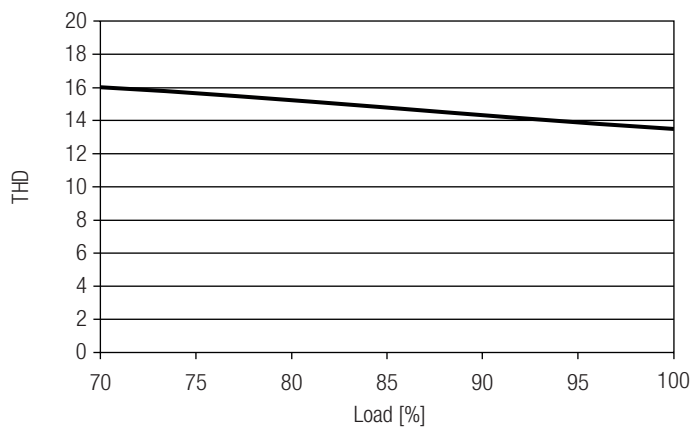

X-ON Electronics

Largest Supplier of Electrical and Electronic Components

Click to view similar products for [LED Power Supplies](#) category:

Click to view products by [Tridonic](#) manufacturer:

Other Similar products are found below :

[ESS015W-1000-12](#) [PDA-WIFI](#) [PIFC-K250F](#) [PITB-K222A](#) [ALD-514012PJ134](#) [LB240S24KH](#) [LMH020-SPLC-0000-0000001](#) [79534](#) [79535](#)
[EUG-200S210DT](#) [ESS030W-1050-21](#) [ESS030W-0900-32](#) [BPOXL 4-12-035](#) [ESS010W-0350-24](#) [ESM060W-1400-42](#) [PDA080B-1A0G](#)
[PDA150B-S1A5G](#) [SLM140W-1.05-130-ZA](#) [ESS015W-0700-18](#) [EUD-150S350DVA](#) [LWA320-C420-ARK-B](#) [HVG-240-48AB](#) [HVG-320-](#)
[36AB](#) [HVG-320-54AB](#) [ELG-240-C1400AB](#) [EUK-150S105DV](#) [BXCS-12Z-N2P-B1-A](#) [BXPR-WN-01-A](#) [BXCS-12D-N2P-01-A](#) [BXCS-](#)
[12W-N2P-01-A](#) [HLG-185H-C1400AB](#) [980100001200394](#) [LC 14W 250-350MA FLEXC R ADV2](#) [LC 24W 500-600MA FLEXC R ADV2](#)
[LC 36W 850-900MA FLEXC R ADV2](#) [LC 50W 200-350ML 170V FLEXC LP SNC4](#) [LC 25W 200-350ML 70V FLEXC LP SNC4](#) [LC 35W](#)
[200-350ML 121V FLEXC LP SNC4](#) [LCBI 10W 350MA PHASE-CUT/1-10V LP](#) [LC 13W 300MA FIXC C SNC](#) [LC 10W 250MA FIXC SC](#)
[SNC2](#) [LC 35W 800MA FIXC SR ADV2](#) [LC 38W 900MA FIXC SR ADV2](#) [LC 34W 800MA FIXC SC ADV2](#) [LC 44W 1050MA FIXC SC](#)
[ADV2](#) [LC 38W 900MA 42V FIXC SRL ADV2](#) [HVG-320-48AB](#) [CNB50W-1200-42-CAS](#) [CNB30W-0600-42-CAS](#) [LCI 100W 1400MA TEC](#)

[C](#)