



### Driver LC 10W 250/350/500/700mA fixC SR SNC

essence series

#### Product description

- Independent driver with strain-relief housing
- Extra flat housing for constrained installation conditions (small ceiling cut outs and low ceiling voids)
- For luminaires with M and MM as per EN 60598, VDE 0710 and VDE 0711
- Temperature protection as per EN 61347-2-13 C5e
- Output current 250, 350, 500 or 700 mA
- Max. output power 10 W
- Nominal lifetime up to 50,000 h
- 5 years guarantee (conditions at [www.tridonic.com](http://www.tridonic.com))



#### Housing properties

- Casing: polycarbonat, white
- Type of protection IP20
- Push-in terminals
- 2 separate strain relief parts for input and output cables with highly robust clamps

#### Functions

- Overload protection
- Short-circuit protection
- No-load protection
- No output current overshoot at mains on/off



**Standards**, page 3

**Wiring diagrams and installation examples**, page 4





### Driver LC 10W 250/350/500/700mA fixC SR SNC

essence series

#### Technical data

Rated supply voltage	220 – 240 V
Input voltage, AC	198 – 264 V
$\lambda$ at full load <sup>①</sup>	0.90C
$\lambda$ at min. load <sup>①</sup>	0.85C
Mains frequency	50/60 Hz
Overvoltage protection	320 V AC, 1 h
THD (at 230 V, 50 Hz, full load)	≤ 20 %
THD (at 230 V, 50 Hz, min. load)	≤ 20 %
Output current tolerance <sup>②</sup>	± 7.5 %
Typ. output LF current ripple at full load	± 40 %
Starting time (at 230 V, 50 Hz, full load)	≤ 0.5 s
Turn off time (at 230 V, 50 Hz, full load)	≤ 0.5 s
Hold on time at power failure	0 s
Ambient temperature $t_a$	-20 ... +50 °C
Ambient temperature $t_a$ (at lifetime 50,000 h)	40 °C
Storage temperature $t_s$	-40 ... +80 °C
Lifetime	up to 50,000 h
Guarantee (conditions at www.tridonic.com)	5 years
Dimensions L x W x H	101.5 x 51 x 22 mm

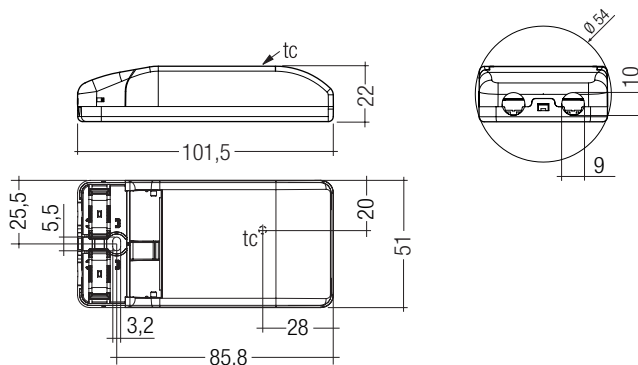

#### Ordering data

Type	Article number <sup>③</sup>	Packaging, carton	Packaging, low volume	Packaging, high volume	Weight per pc.
LC 10W 250mA fixC SR SNC	87500580	20 pc(s).	380 pc(s).	3,420 pc(s).	0.062 kg
LC 10W 350mA fixC SR SNC	87500581	20 pc(s).	380 pc(s).	3,420 pc(s).	0.061 kg
LC 10W 500mA fixC SR SNC	87500582	20 pc(s).	380 pc(s).	3,420 pc(s).	0.061 kg
LC 10W 700mA fixC SR SNC	87500583	20 pc(s).	380 pc(s).	3,420 pc(s).	0.061 kg

#### Specific technical data

Type	Output current <sup>④</sup>	Input current (at 230 V, 50 Hz, full load)	Max. input power	Typ. power consumption (at 230 V, 50 Hz, full load)	Output power	Efficiency at full load <sup>⑤</sup>	Efficiency at min. load <sup>⑤</sup>	Min. forward voltage <sup>⑥</sup>	Max. forward voltage <sup>⑥</sup>	Max. output voltage	Max. peak output current at full load <sup>⑦</sup>	Max. peak output current at min. load <sup>⑦</sup>	Max. casing temperature $t_c$
LC 10W 250mA fixC SR SNC	250 mA	60 mA	12.5 W	12 W	7 – 10 W	84 %	83 %	28 V	40.0 V	50 V	350 mA	420 mA	80 °C
LC 10W 350mA fixC SR SNC	350 mA	60 mA	12.5 W	12 W	7 – 10 W	83 %	81 %	20 V	28.6 V	42 V	550 mA	600 mA	80 °C
LC 10W 500mA fixC SR SNC	500 mA	60 mA	12.5 W	12 W	7 – 10 W	83 %	80 %	14 V	20.0 V	35 V	780 mA	820 mA	80 °C
LC 10W 700mA fixC SR SNC	700 mA	65 mA	12.5 W	12 W	7 – 10 W	81 %	78 %	10 V	14.2 V	25 V	1,100 mA	1,150 mA	80 °C

<sup>①</sup> Test result at 230 V, 50 Hz.

<sup>②</sup> The trend between min. and full load is linear.

<sup>③</sup> Output current is mean value.

<sup>④</sup> KC approval mark for art. no.: 87500580, 87500581 and 87500582.

### Standards

EN 55015  
EN 60598-1  
EN 61000-3-2  
EN 61000-3-3  
EN 61347-1  
EN 61347-2-13  
EN 61547  
EN 62384

### Overload protection

If the maximum load is exceeded by a defined internal limit, the LED Driver will protect itself. After elimination of the overload the nominal operation is restored automatically.

### Short-circuit behaviour

In case of a short circuit on the secondary side (LED) the LED Driver switches into hic-cup mode. After the removal of the short-circuit fault the LED Driver will recover automatically.

### No-load operation

The LED Driver works in burst working mode to provide a constant output voltage regulation which allows the application to be able to work safely when LED string open due to a failure.

In no-load operation the output voltage will not exceed the specified max. output voltage (see page 2).

### Glow wire test

according to EN 60598-1 with increased temperature of 850 °C passed.

### Mounting of device

Max. torque for fixing: 0.5 Nm/M4

### Conditions of use and storage

Humidity: 5 % up to max. 85 %,  
not condensed  
(max. 56 days/year at 85%)

Storage temperature: -40 °C up to max. +80 °C

The devices have to be within the specified temperature range (ta) before they can be operated.

### Expected lifetime

Type	ta	40 °C	50 °C	
<b>LC 10W 250mA fixC SR SNC</b>	tc	70 °C	80 °C	x
	Lifetime	50,000 h	30,000 h	x
<b>LC 10W 350mA fixC SR SNC</b>	tc	70 °C	80 °C	x
	Lifetime	50,000 h	30,000 h	x
<b>LC 10W 500mA fixC SR SNC</b>	tc	70 °C	80 °C	x
	Lifetime	50,000 h	30,000 h	x
<b>LC 10W 700mA fixC SR SNC</b>	tc	70 °C	80 °C	x
	Lifetime	50,000 h	30,000 h	x

The LED Drivers are designed for a lifetime stated above under reference conditions and with a failure probability of less than 10 %.

The relation of tc to ta temperature depends also on the luminaire design. If the measured tc temperature is approx. 5 K below tc max., ta temperature should be checked and eventually critical components (e.g. ELCAP) measured. Detailed information on request.

### Maximum loading of automatic circuit breakers in relation to inrush current

Automatic circuit breaker type									Inrush current	
	C10	C13	C16	C20	B10	B13	B16	B20	I <sub>max</sub>	Time
Installation Ø	1.5 mm <sup>2</sup>	1.5 mm <sup>2</sup>	1.5 mm <sup>2</sup>	2.5 mm <sup>2</sup>	1.5 mm <sup>2</sup>	1.5 mm <sup>2</sup>	1.5 mm <sup>2</sup>	2.5 mm <sup>2</sup>		
<b>LC 10W 250mA fixC SR SNC</b>	120	160	200	240	100	130	160	200	8 A	80 µs
<b>LC 10W 350mA fixC SR SNC</b>	120	160	200	240	100	130	160	200	8 A	80 µs
<b>LC 10W 500mA fixC SR SNC</b>	120	160	200	240	100	130	160	200	8 A	80 µs
<b>LC 10W 700mA fixC SR SNC</b>	120	160	200	240	100	130	160	200	8 A	80 µs

This are max. values calculated out of inrush current! Please consider not to exceed the maximum rated continuous current of the circuit breaker. Calculation uses typical values from ABB series S200 as a reference. Actual values may differ due to used circuit breaker types and installation environment.

### Harmonic distortion in the mains supply (at 230 V / 50 Hz and full load) in %

	THD	3.	5.	7.	9.	11.
<b>LC 10W 250mA fixC SR SNC</b>	< 20	< 12	< 10	< 6	< 6	< 5
<b>LC 10W 350mA fixC SR SNC</b>	< 20	< 15	< 8	< 8	< 8	< 5
<b>LC 10W 500mA fixC SR SNC</b>	< 20	< 10	< 8	< 6	< 6	< 6
<b>LC 10W 700mA fixC SR SNC</b>	< 20	< 15	< 10	< 8	< 5	< 5

**Installation instructions**

The LED module and all contact points within the wiring must be sufficiently insulated against 3 kV surge voltage.

Air and creepage distance must be maintained.

**Replace LED module**

1. Mains off
2. Remove LED module
3. Wait for 10 seconds
4. Connect LED module again

Hot plug-in or secondary switching of LEDs is not permitted and may cause a very high current to the LEDs.

**Wiring type and cross section**

The wiring can be in stranded wires with ferrules or solid. For perfect function of the cage clamp terminals the strip length should be 9 – 10 mm for the input terminal.

The max. torque at the clamping screw (M3) is 0.2 Nm.

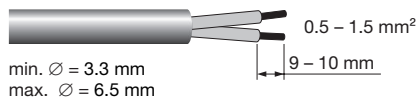
**Wiring guidelines**

- All connections must be kept as short as possible to ensure good EMI behaviour.
- Mains leads should be kept apart from LED Driver and other leads (ideally 5 – 10 cm distance)
- Max. length of output wires is 2 m.
- To comply with the EMC regulations run the secondary wires (LED module) in parallel.
- Secondary switching is not permitted.
- Incorrect wiring can damage LED modules.
- To avoid the damage of the Driver, the wiring must be protected against short circuits to earth (sharp edged metal parts, metal cable clips, louver, etc.).

**Fixing conditions**

Dry, acidfree, oilfree, fatfree. It is not allowed to exceed the maximum ambient temperature ( $t_a$ ) stated on the device. Minimum distances stated below are recommendations and depend on the actual luminaire.

Is not suitable for fixing in corner.

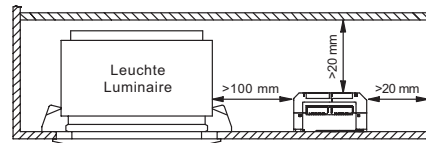
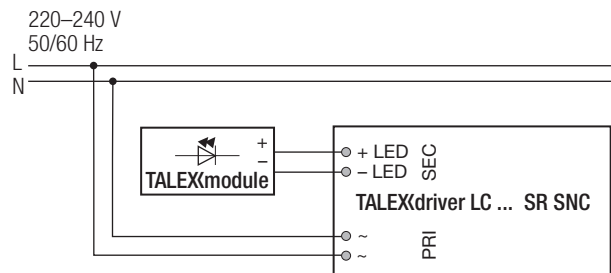
**Wiring diagram****Insulation and electric strength testing of luminaires**

Electronic devices can be damaged by high voltage. This has to be considered during the routine testing of the luminaires in production.

According to IEC 60598-1 Annex Q (informative only!) or ENEC 303-Annex A, each luminaire should be submitted to an insulation test with 500 V<sub>DC</sub> for 1 second. This test voltage should be connected between the interconnected phase and neutral terminals and the earth terminal.

The insulation resistance must be at least 2 MΩ.

As an alternative, IEC 60598-1 Annex Q describes a test of the electrical strength with 1500 V<sub>AC</sub> (or 1.414 x 1500 V<sub>DC</sub>). To avoid damage to the electronic devices this test must not be conducted.

**Maximum number of switching cycles**

All LED Driver are tested with 50,000 switching cycles.

**Additional information**

Additional technical information at [www.tridonic.com](http://www.tridonic.com) → Technical Data

Lifetime declarations are informative and represent no warranty claim.

No warranty if device was opened.

**Diagrams LC 10W 250mA fixC SR SNC**

Efficiency vs load

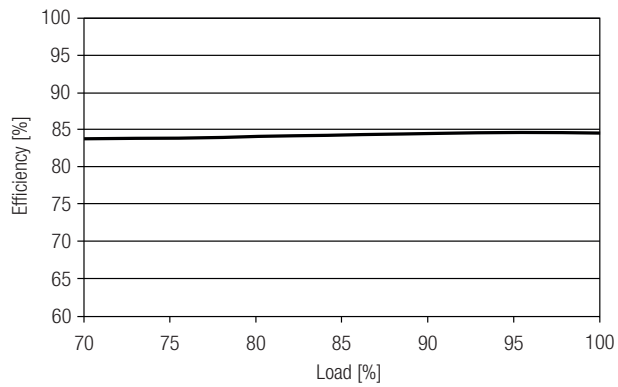

Power factor vs load

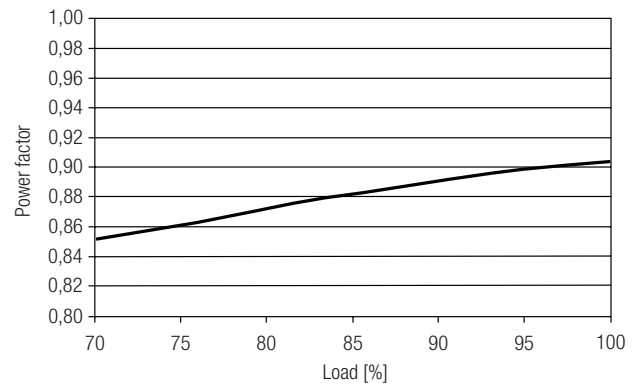

Input power vs load

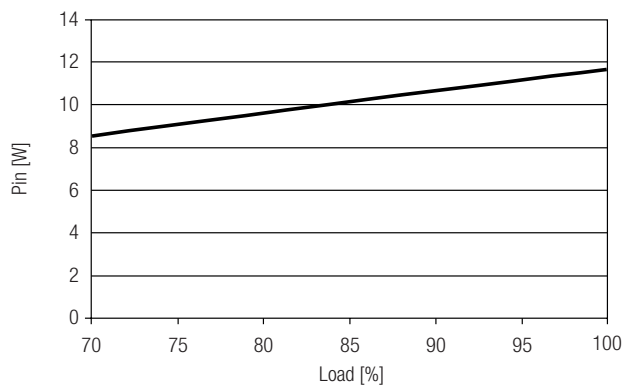

Input current vs load

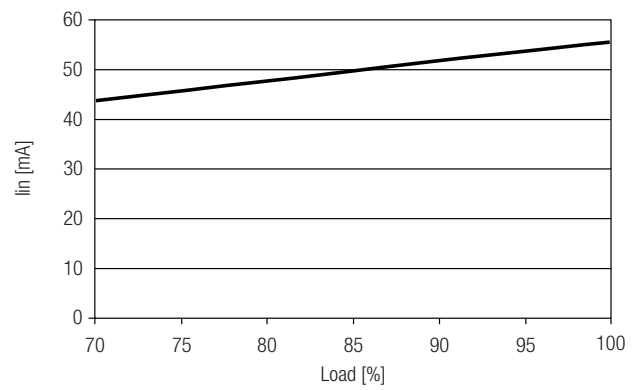

THD vs load

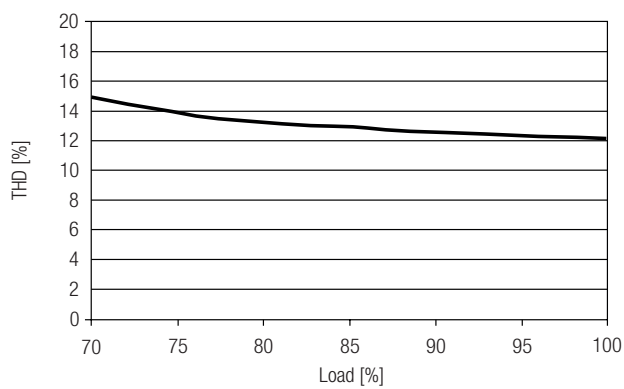

**Diagrams LC 10W 350mA fixC SR SNC**

Efficiency vs load

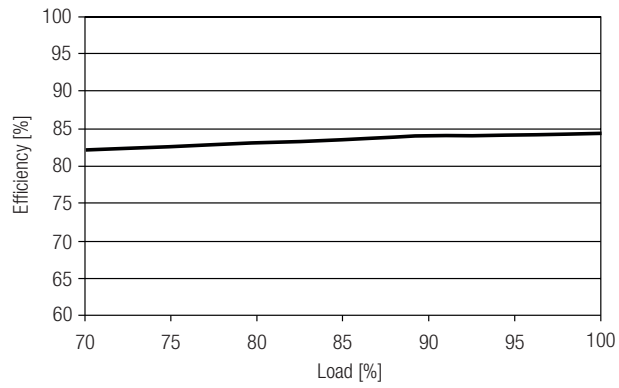

Power factor vs load

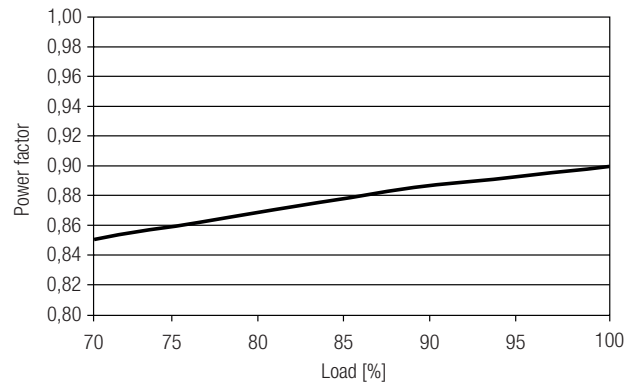

Input power vs load

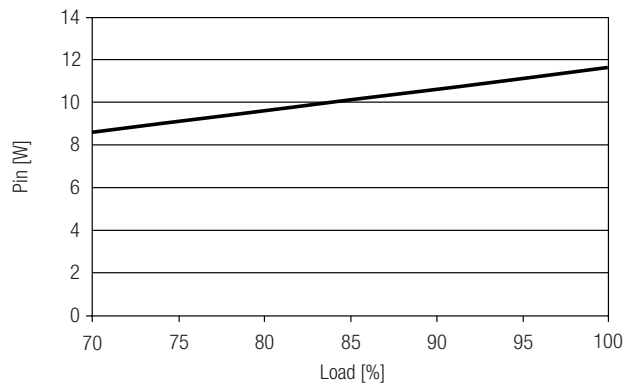

Input current vs load

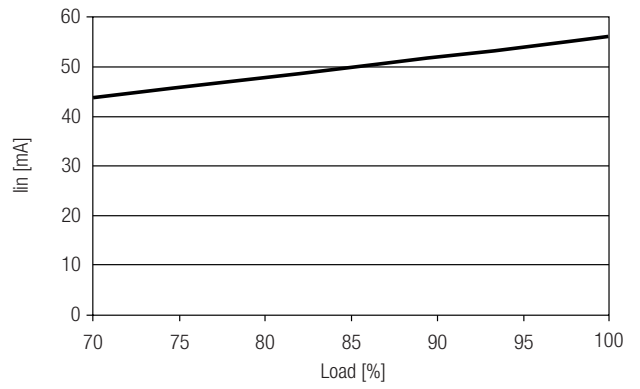

THD vs load

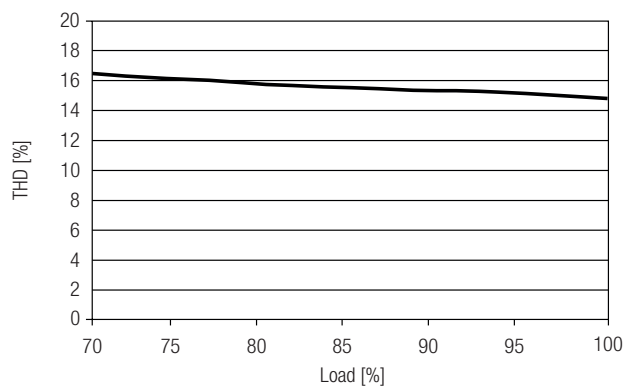

**Diagrams LC 10W 500mA fixC SR SNC**

Efficiency vs load

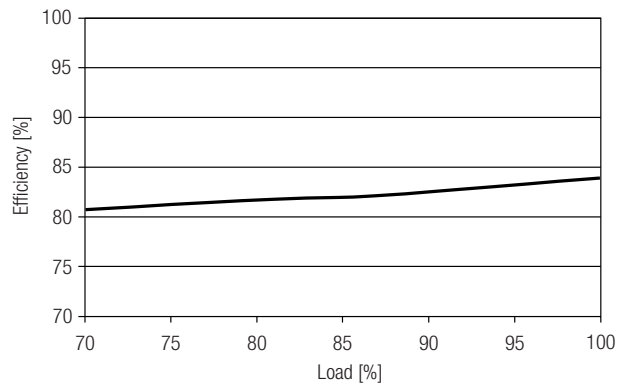

Power factor vs load

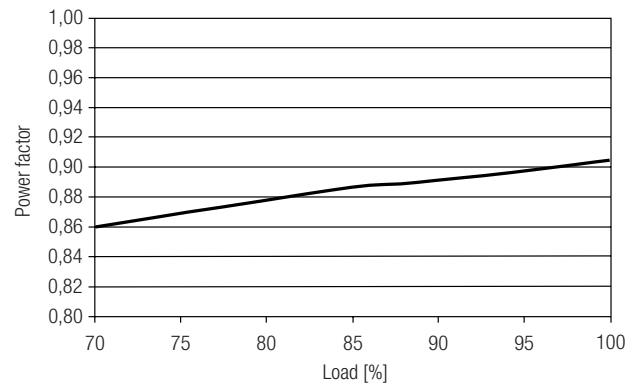

Input power vs load

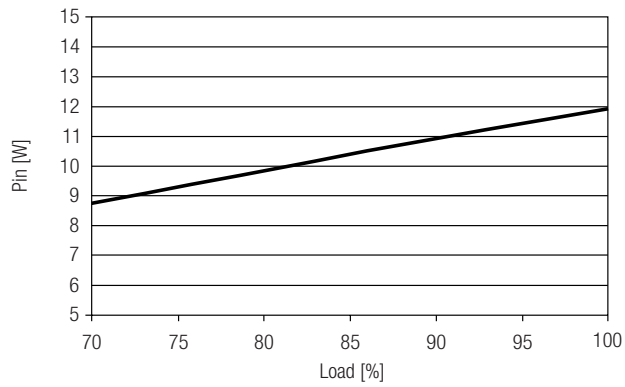

Input current vs load

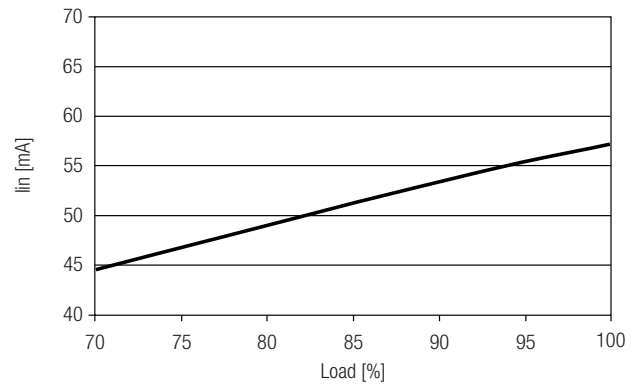

THD vs load

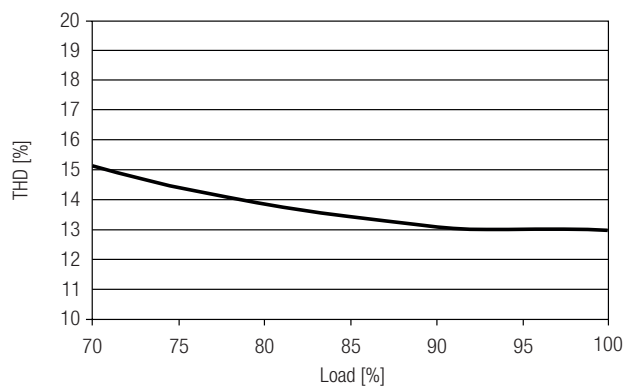

**Diagrams LC 10W 700mA fixC SR SNC**

Efficiency vs load

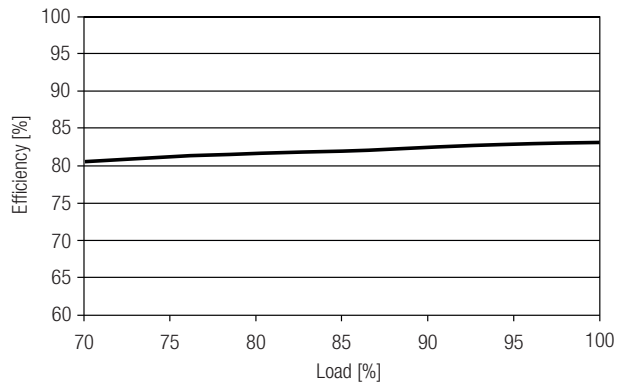

Power factor vs load

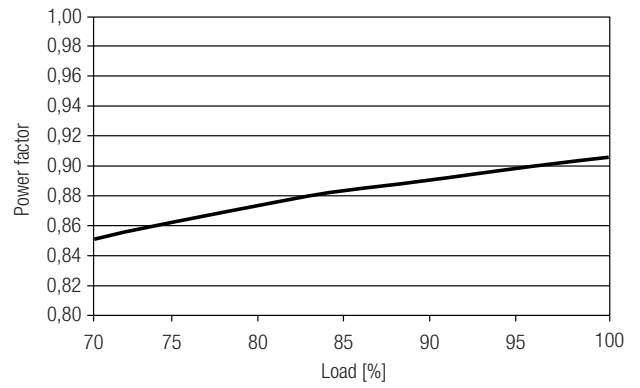

Input power vs load

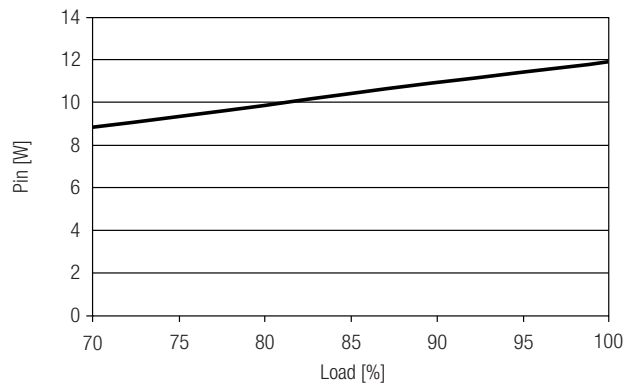

Input current vs load

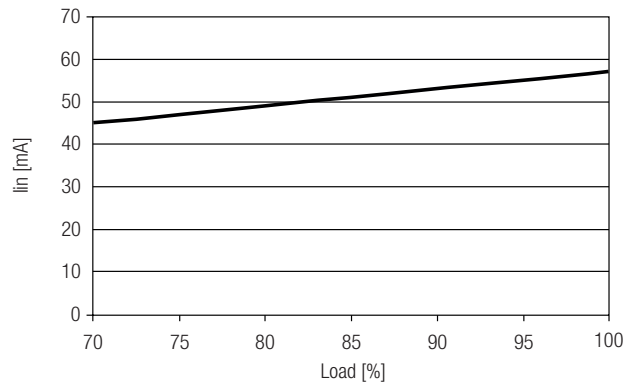

THD vs load

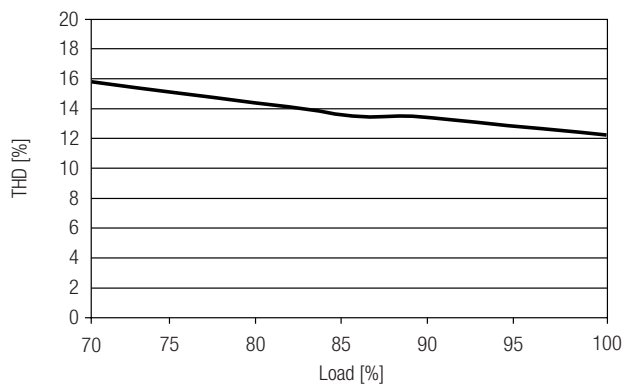



## X-ON Electronics

Largest Supplier of Electrical and Electronic Components

*Click to view similar products for [LED Power Supplies](#) category:*

*Click to view products by [Tridonic](#) manufacturer:*

Other Similar products are found below :

[ESS015W-1000-12](#) [PDA-WIFI](#) [PIFC-K250F](#) [PITB-K222A](#) [ALD-514012PJ134](#) [LB240S24KH](#) [LMH020-SPLC-0000-0000001](#) [79534](#) [79535](#)  
[EUG-200S210DT](#) [ESS030W-1050-21](#) [ESS030W-0900-32](#) [BPOXL 4-12-035](#) [ESS010W-0350-24](#) [ESM060W-1400-42](#) [PDA080B-1A0G](#)  
[PDA150B-S1A5G](#) [SLM140W-1.05-130-ZA](#) [ESS015W-0700-18](#) [EUD-150S350DVA](#) [LWA320-C420-ARK-B](#) [HVG-240-48AB](#) [HVG-320-36AB](#) [HVG-320-54AB](#) [ELG-240-C1400AB](#) [EUK-150S105DV](#) [BXCS-12Z-N2P-B1-A](#) [BXPR-WN-01-A](#) [BXCS-12D-N2P-01-A](#) [BXCS-12W-N2P-01-A](#) [LC 50W 200-350ML 170V FLEXC LP SNC4](#) [LC 25W 200-350ML 70V FLEXC LP SNC4](#) [LC 35W 200-350ML 121V FLEXC LP SNC4](#) [LC 10W 250MA FIXC SC SNC2](#) [LC 35W 800MA FIXC SR ADV2](#) [LC 38W 900MA FIXC SR ADV2](#) [LC 34W 800MA FIXC SC ADV2](#) [LC 44W 1050MA FIXC SC ADV2](#) [LC 38W 900MA 42V FIXC SRL ADV2](#) [HVG-320-48AB](#) [CNB50W-1200-42-CAS](#) [CNB30W-0600-42-CAS](#) [LCI 100W 1400MA TEC C](#) [LCI 100W 2100MA TEC C](#) [LCI 150W 1750MA TEC C](#) [LCI 150W 2100MA TEC C](#) [87500284](#) [87500447](#) [LC 50W 1200MA FIXC SR SNC](#) [87500554](#)