



Driver LC 30W 350/500/700mA fixC SR SNC2

essence series

Product description

- Independent LED Driver with cable clamps
- For luminaires with M and MM as per EN 60598, VDE 0710 and VDE 0711
- Temperature protection as per EN 61347-2-13 C5e
- Output current 350, 500 or 700 mA
- Max. output power 30 W
- Nominal life-time up to 50,000 h
- 5-year guarantee (conditions at www.tridonic.com)



Housing properties

- Casing: polycarbonat, white
- Type of protection IP20
- Push-in terminals
- 2 separate strain relief parts for input and output cables with highly robust clamps

Functions

- Overload protection
- Short-circuit protection
- No-load protection
- No output current overshoot at mains on/off
- Burst protection voltage 1 kV
- Surge protection voltage 1 kV (L to N)
- Surge protection voltage 2 kV (L/N to earth)

Typical applications

- For spot light and downlight in retail and hospitality application
- For panel light and area light in office and education application



Standards, page 3

Wiring diagrams and installation examples, page 3

IP20 SELV                                            

1. Standards

EN 55015
EN 61000-3-2
EN 61000-3-3
EN 61347-1
EN 61347-2-13
EN 61547
EN 60598-1
EN 62384

1.1 Glow wire test

according to EN 60598-1 with increased temperature of 850 °C passed.

2. Thermal details and life-time

2.1 Expected life-time

Expected life-time			
Type	ta	40 °C	50 °C
LC 30/350/86 fixC SR SNC2	tc	65 °C ^①	75 °C ^①
	Life-time	50,000 h	30,000 h
LC 30/500/54 fixC SR SNC2	tc	65 °C ^①	75 °C ^①
	Life-time	50,000 h	30,000 h
LC 30/700/43 fixC SR SNC2	tc	70 °C ^①	80 °C ^①
	Life-time	50,000 h	30,000 h

^① Test result at max. output voltage.

The LED Drivers are designed for a life-time stated above under reference conditions and with a failure probability of less than 10 %. Life-time declarations are informative and represent no warranty claim.

The relation of tc to ta temperature depends also on the luminaire design. If the measured tc temperature is approx. 5 K below tc max., ta temperature should be checked and eventually critical components (e.g. ELCAP) measured. Detailed information on request.

3. Installation / wiring

3.1 Circuit diagram

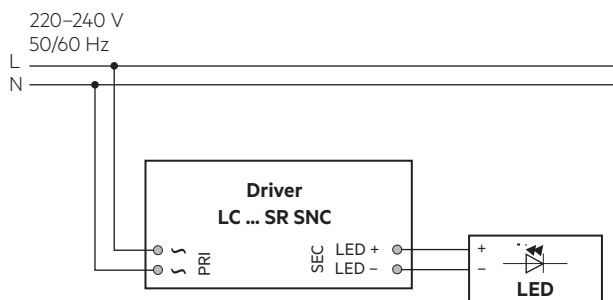

3.2 Wiring type and cross section

The wiring can be in stranded wires with ferrules or solid with a cross section of 0.5–1.5 mm². Strip 8.5–9.5 mm of insulation from the cables to ensure perfect operation of the push-wire terminals. Use one wire for each terminal connector only. The max. torque at the clamping screw (M3) is 0.3 Nm.

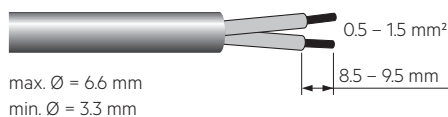

3.3 Release of the wiring

Press down the “push button” and remove the cable from front.

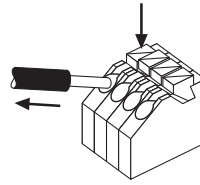

3.4 Fixing conditions

Dry, acidfree, oilfree, fatfree. It is not allowed to exceed the maximum ambient temperature (ta) stated on the device. Minimum distances stated below are recommendations and depend on the actual luminaire. Is not suitable for fixing in corner.

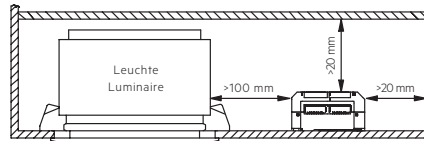

3.5 Wiring guidelines

- All connections must be kept as short as possible to ensure good EMI behaviour.
- Mains leads should be kept apart from LED Driver and other leads (ideally 5 – 10 cm distance)
- Max. length of output wires is 2 m.
- To comply with the EMC regulations run the secondary wires (LED module) in parallel.
- Secondary switching is not permitted.
- Incorrect wiring can damage LED modules.
- To avoid the damage of the Driver, the wiring must be protected against short circuits to earth (sharp edged metal parts, metal cable clips, louver, etc.).

3.6 Replace LED module

1. Mains off
2. Remove LED module
3. Wait for 20 seconds
4. Connect LED module again

Hot plug-in or secondary switching of LEDs is not permitted and may cause a very high current to the LEDs.

3.7 Installation instructions

The LED module and all contact points within the wiring must be sufficiently insulated against 3 kV surge voltage. Air and creepage distance must be maintained.

3.8 Mounting of device

Max. torque for fixing: 0.5 Nm/M4

4. Electrical values

4.1 Diagrams LC 30W 350mA fixC SR SNC2

4.1.1 Efficiency vs load

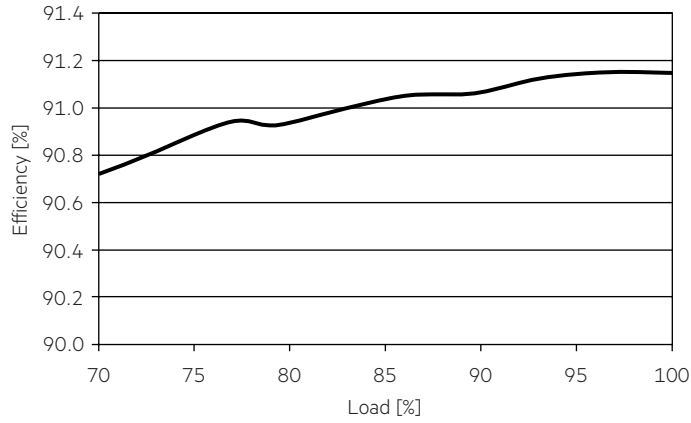

4.1.4 Input current vs load

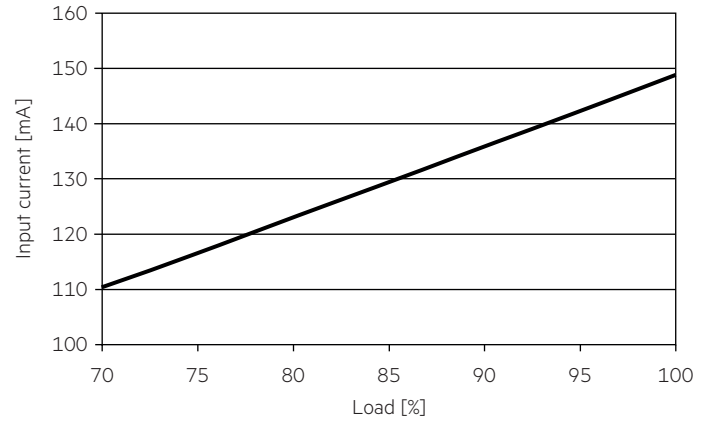

4.1.2 Power factor vs load

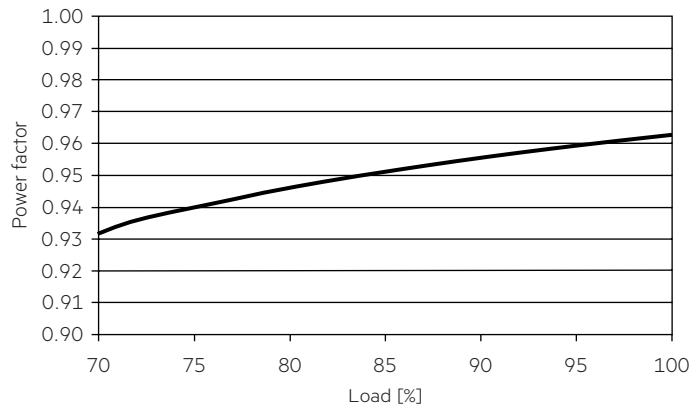

4.1.5 THD vs load

THD without harmonic < 5 mA (0.6 %) of the input current:

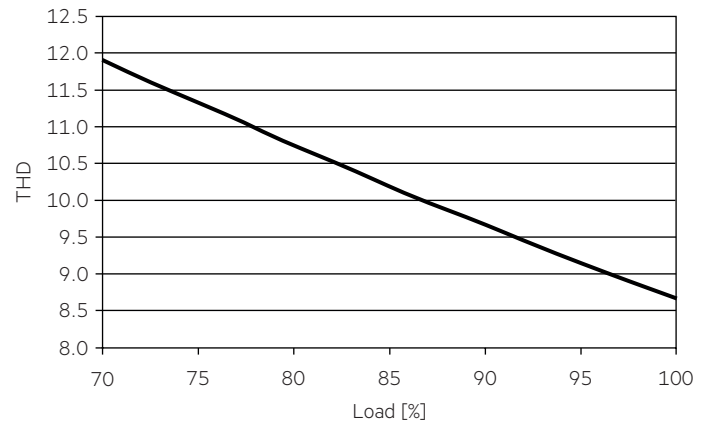

4.1.3 Input power vs load

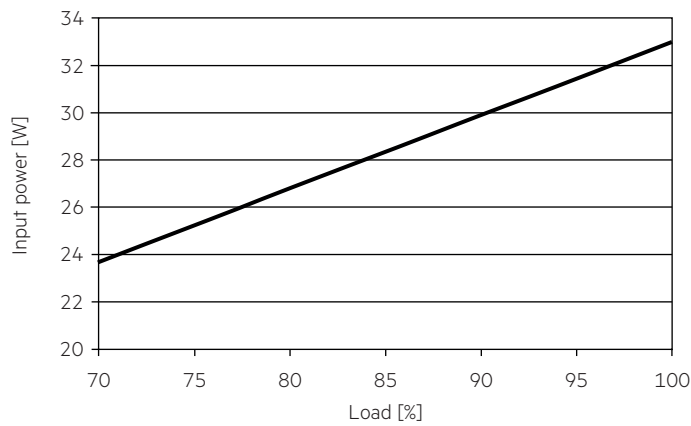

4.2 Diagrams LC 30W 500mA fixC SR SNC2

4.2.1 Efficiency vs load

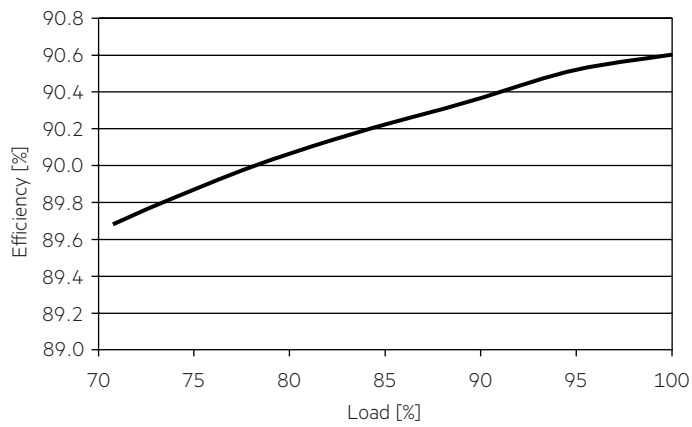

4.2.4 Input current vs load

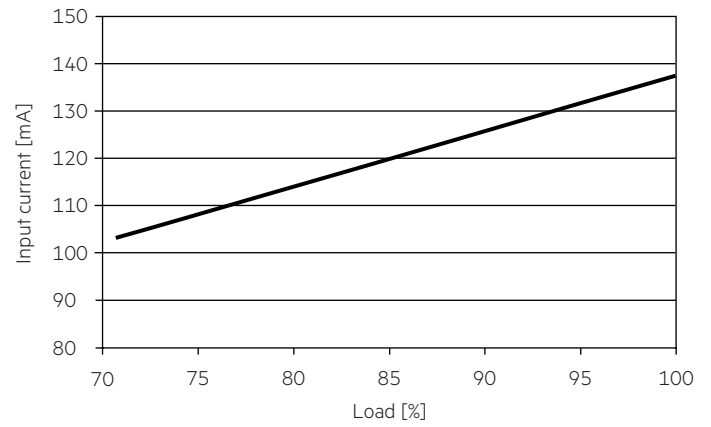

4.2.2 Power factor vs load

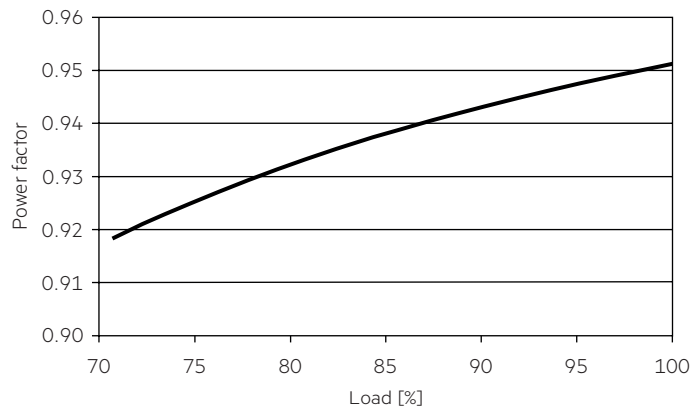

4.2.5 THD vs load

THD without harmonic < 5 mA (0.6 %) of the input current:

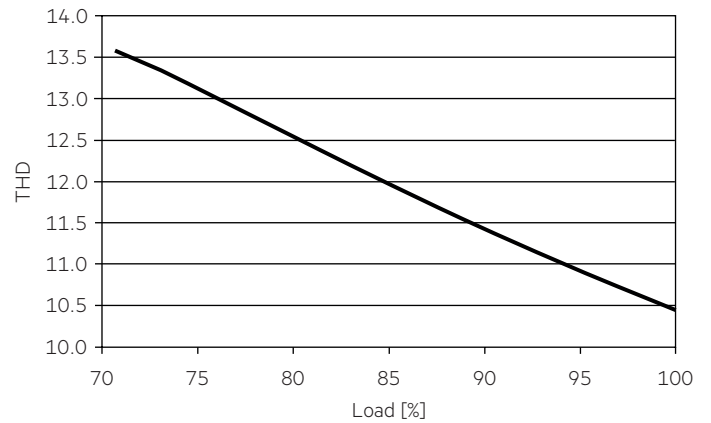

4.2.3 Input power vs load

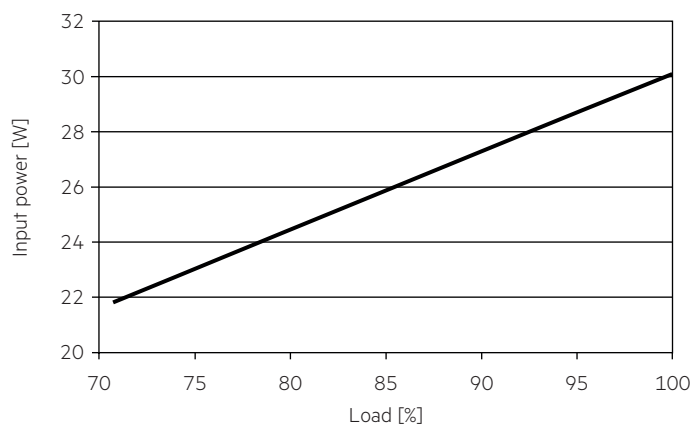

4.3 Diagrams LC 30W 700mA fixC SR SNC2

4.3.1 Efficiency vs load

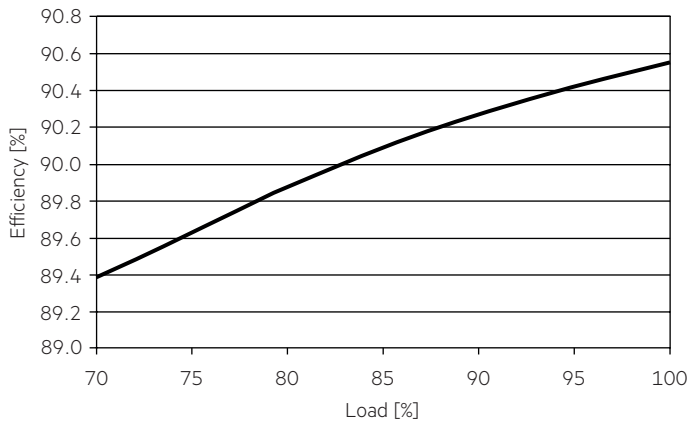

4.3.4 Input current vs load

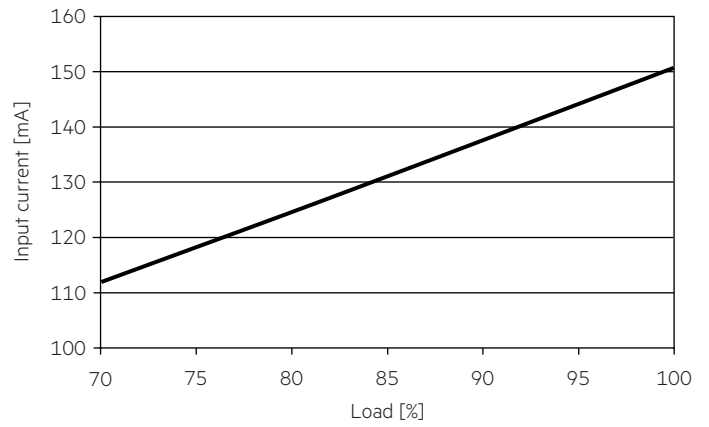

4.3.2 Power factor vs load

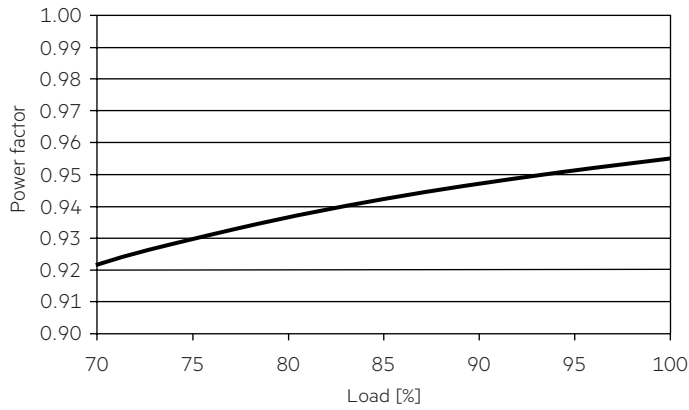

4.3.5 THD vs load

THD without harmonic < 5 mA (0.6 %) of the input current:

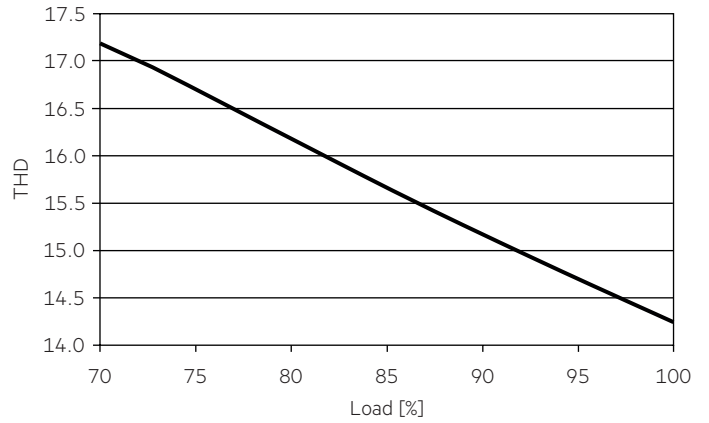

4.3.3 Input power vs load

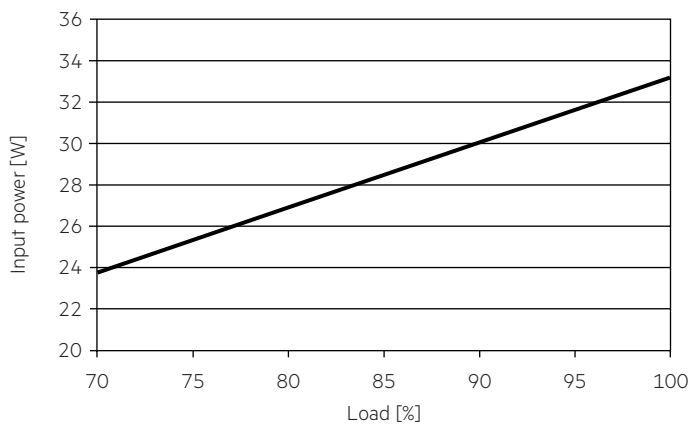

4.4 Maximum loading of automatic circuit breakers in relation to inrush current

Automatic circuit breaker type	C10	C13	C16	C20	B10	B13	B16	B20	Inrush current	
Installation Ø	1.5 mm ²	1.5 mm ²	1.5 mm ²	2.5 mm ²	1.5 mm ²	1.5 mm ²	1.5 mm ²	2.5 mm ²	I _{max}	Time
LC 30/350/86 fixC SR SNC2	55	70	85	110	55	70	85	110	8 A	40 µs
LC 30/500/54 fixC SR SNC2	55	70	85	110	55	70	85	110	8 A	40 µs
LC 30/700/43 fixC SR SNC2	55	70	85	110	55	70	85	110	8 A	40 µs

These are max. values calculated out of continuous current running the device on full load.
There is no limitation due to inrush current.
If load is smaller than full load for calculation only continuous current has to be considered.

4.5 Harmonic distortion in the mains supply (at 230 V / 50 Hz and full load) in %

	THD	3.	5.	7.	9.	11.
LC 30/350/86 fixC SR SNC2	< 15	< 15	< 5	< 4	< 3	< 3
LC 30/500/54 fixC SR SNC2	< 15	< 15	< 5	< 4	< 3	< 3
LC 30/700/43 fixC SR SNC2	< 18	< 15	< 5	< 4	< 3	< 3

Acc. to 6100-3-2. Harmonics < 5 mA or < 0.6 % (whatever is greater) of the input current are not considered for calculation of THD.

5. Functions

5.1 Short-circuit behaviour

In case of a short circuit on the secondary side (LED) the LED Driver switches into hic-cup mode. After elimination of the short-circuit fault the LED Driver will recover automatically.

5.2 No-load operation

The LED Driver works in burst working mode to provide a constant output voltage regulation which allows the application to be able to work safely when LED string opens due to a failure.

5.3 Overload protection

If the maximum load is exceeded by a defined internal limit, the LED Driver will protect itself and LED may flicker. After elimination of the overload, the nominal operation is restored automatically.

6. Miscellaneous

6.1 Insulation and electric strength testing of luminaires

Electronic devices can be damaged by high voltage. This has to be considered during the routine testing of the luminaires in production.

According to IEC 60598-1 Annex Q (informative only!) or ENEC 303-Annex A, each luminaire should be submitted to an insulation test with 500 V_{DC} for 1 second. This test voltage should be connected between the interconnected phase and neutral terminals and the earth terminal.
The insulation resistance must be at least 2 MΩ.

As an alternative, IEC 60598-1 Annex Q describes a test of the electrical strength with 1500 V_{AC} (or 1.414 x 1500 V_{DC}). To avoid damage to the electronic devices this test must not be conducted.

6.2 Conditions of use and storage

Humidity: 5 % up to max. 85 %, not condensed (max. 56 days/year at 85 %)

Storage temperature: -40 °C up to max. +80 °C

The devices have to be within the specified temperature range (t_a) before they can be operated.

6.3 Maximum number of switching cycles

All LED Driver are tested with 50,000 switching cycles.

6.4 Additional information

Additional technical information at www.tridonic.com → Technical Data

Life-time declarations are informative and represent no warranty claim.
No warranty if device was opened.

X-ON Electronics

Largest Supplier of Electrical and Electronic Components

Click to view similar products for [LED Power Supplies](#) category:

Click to view products by [Tridonic](#) manufacturer:

Other Similar products are found below :

[ESS015W-1000-12](#) [PDA-WIFI](#) [PIFC-K250F](#) [PITB-K222A](#) [ALD-514012PJ134](#) [LB240S24KH](#) [LMH020-SPLC-0000-0000001](#) [79534](#) [79535](#)
[EUG-200S210DT](#) [ESS030W-1050-21](#) [ESS030W-0900-32](#) [BPOXL 4-12-035](#) [ESS010W-0350-24](#) [ESM060W-1400-42](#) [PDA080B-1A0G](#)
[PDA150B-S1A5G](#) [SLM140W-1.05-130-ZA](#) [ESS015W-0700-18](#) [EUD-150S350DVA](#) [LWA320-C420-ARK-B](#) [HVG-240-48AB](#) [HVG-320-](#)
[36AB](#) [HVG-320-54AB](#) [ELG-240-C1400AB](#) [EUK-150S105DV](#) [BXCS-12Z-N2P-B1-A](#) [BXPR-WN-01-A](#) [BXCS-12D-N2P-01-A](#) [BXCS-](#)
[12W-N2P-01-A](#) [HLG-185H-C1400AB](#) [980100001200394](#) [LC 14W 250-350MA FLEXC R ADV2](#) [LC 24W 500-600MA FLEXC R ADV2](#)
[LC 36W 850-900MA FLEXC R ADV2](#) [LC 50W 200-350ML 170V FLEXC LP SNC4](#) [LC 25W 200-350ML 70V FLEXC LP SNC4](#) [LC 35W](#)
[200-350ML 121V FLEXC LP SNC4](#) [LCBI 10W 350MA PHASE-CUT/1-10V LP](#) [LC 13W 300MA FIXC C SNC](#) [LC 10W 250MA FIXC SC](#)
[SNC2](#) [LC 35W 800MA FIXC SR ADV2](#) [LC 38W 900MA FIXC SR ADV2](#) [LC 34W 800MA FIXC SC ADV2](#) [LC 44W 1050MA FIXC SC](#)
[ADV2](#) [LC 38W 900MA 42V FIXC SRL ADV2](#) [HVG-320-48AB](#) [CNB50W-1200-42-CAS](#) [CNB30W-0600-42-CAS](#) [LCI 100W 1400MA TEC](#)

[C](#)