



Driver LC 200W 24V SC SNC

essence series 24 V – not dimmable (IP20)

Product description

- Constant voltage LED driver
- Output voltage 24 V
- Max. output power 200 W
- Dimmable via external PWM LED dimmers attached on output side
- Nominal lifetime up to 50,000 h
- 5-year guarantee (conditions at www.tridonic.com)

Typical application

- Cove lighting, facade accent lighting, ceiling integration, refrigerated displays

Technical details

- 24 V, 200 W
- Small design (325 x 43 x 30 mm) with stretched-compact strain relief
- Output LF voltage ripple (< 120 Hz) $\pm 1.5\%$
- Push terminal for simple wiring

System solution

- Tridonic LLE-FLEX ADV G2 600, 1,200, 1,800 lm/m
- Tridonic LLE-FLEX EXC 600, 1,200, 1,800, 2,500 lm/m
- In connection with Flex accessories wire to PCB plug

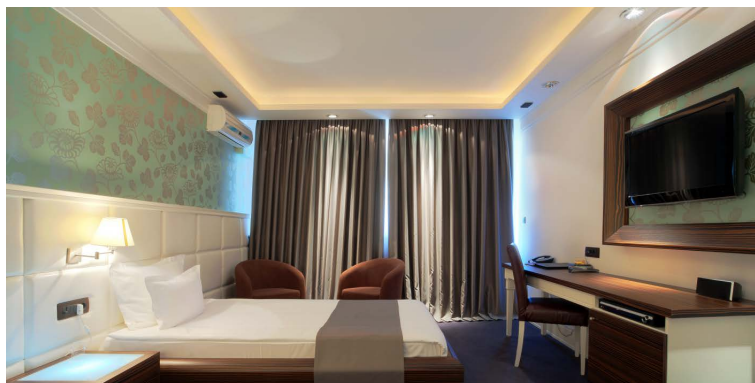

Standards, page 4

IP20 SELV 
RoHS

Driver LC 200W 24V SC SNC

essence series 24 V – not dimmable (IP20)

Technical data

Rated supply voltage	220 – 240 V
AC voltage range	198 – 264 V
Mains frequency	50 / 60 Hz
Overvoltage protection	320 V, 1 h
Typ. current (at 230 V, 50 Hz, full load) ^①	940 mA
Max. input power	215 W
Typ. efficiency (at 230 V / 50 Hz / full load)	93 %
λ (at 230 V, 50 Hz, full load) ^①	0,98
Typ. input current in no-load operation	87 mA
Typ. input power in no-load operation	2 W
In-rush current (peak / duration)	125 A / 121 μ s
THD (at 230 V, 50 Hz, full load) ^①	< 5 %
Output P_{S1}^{LM} (at full load)	≤ 1
Output SVM (at full load)	$\leq 0,4$
Starting time (at 230 V, 50 Hz, full load) ^①	< 0,5 s
Turn off time (at 230 V, 50 Hz, full load)	< 0,5 s
Hold on time at power failure (output)	0 s
Output voltage tolerance	± 1 V
Output LF voltage ripple (< 120 Hz)	$\pm 1,5$ %
Max. output voltage (no-load voltage)	25 V
Burst capability	1 kV
Mains surge capability (between L – N)	1 kV
Mains surge capability (between L/N – PE)	2 kV
Lifetime	up to 50,000 h
Guarantee (conditions at www.tridonic.com)	5 years
Dimensions L x W x H	325 x 43 x 29,8 mm

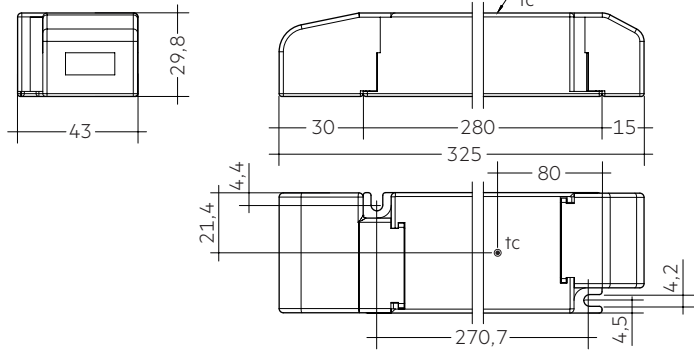

Ordering data

Type	Article number	Packaging carton ^②	Packaging, low volume	Packaging, high volume	Weight per pc.
Multi packaging					
LC 200W 24V SC SNC	87500855	10 pc(s).	80 pc(s).	1040 pc(s).	0.356 kg
Single packaging					
LC 200W 24V SC SNC SP	87500856	20 pc(s).	160 pc(s).	960 pc(s).	0.356 kg

^② The strain relief is included in both packaging variants.
In the single packaging each Driver has also an individual packaging.

Specific technical data

Type	Load	Forward voltage	Output current	Max. output power	Typ. power consumption	Typ. current consumption	Max. casing temperature t_c	Ambient temperature t_a max.
LC 200W 24V SC SNC	30 %	24 V	2,500 mA	60 W	65,0 W	302 mA	70 °C	-20 ... +50 °C
	40 %	24 V	3,333 mA	80 W	85,6 W	387 mA	70 °C	-20 ... +50 °C
	50 %	24 V	4,167 mA	100 W	107,0 W	477 mA	70 °C	-20 ... +50 °C
	60 %	24 V	5,000 mA	120 W	128,2 W	568 mA	75 °C	-20 ... +50 °C
	70 %	24 V	5,833 mA	140 W	150,0 W	660 mA	75 °C	-20 ... +50 °C
	80 %	24 V	6,667 mA	160 W	171,0 W	750 mA	75 °C	-20 ... +50 °C
	90 %	24 V	7,500 mA	180 W	193,0 W	845 mA	80 °C	-20 ... +50 °C
	100 %	24 V	8,333 mA	200 W	215,0 W	940 mA	80 °C	-20 ... +45 °C

^① Valid at 100 % dimming level.

1. Standards

EN 55015
EN 61000-3-2
EN 61000-3-3
EN 61347-1
EN 61347-2-13
EN 62384
EN 61547
IEC 60335-1
IEC 60335-2-89

1.1 Glow wire test

according to EN 61347-1 with increased temperature of 850 °C passed.

2. Thermal details and lifetime

2.1 Expected lifetime

Expected lifetime					
Type	Output load	ta	40 °C	45 °C	50 °C
LC 200W 24V SC SNC	> 180 ... ≤ 200 W	tc	75 °C	80 °C	–
		Lifetime	60,000 h	45,000 h	–
	≥ 160 ... ≤ 180 W	tc	70 °C	75 °C	80 °C
		Lifetime	100,000 h	75,000 h	55,000 h
	≥ 140 ... < 160 W	tc	70 °C	75 °C	80 °C
		Lifetime	>100,000 h	>100,000 h	90,000 h
< 140 W	tc	70 °C	75 °C	80 °C	
	Lifetime	>100,000 h	>100,000 h	>100,000 h	

The LED control gear is designed for a lifetime stated above under reference conditions and with a failure probability of less than 10 %. The relation of tc to ta temperature depends also on the luminaire design. If the measured tc temperature is approx. 5 K below tc max., ta temperature should be checked and eventually critical components (e.g. ELCAP) measured. Detailed information on request.

3. Installation / wiring

3.1 Circuit diagram

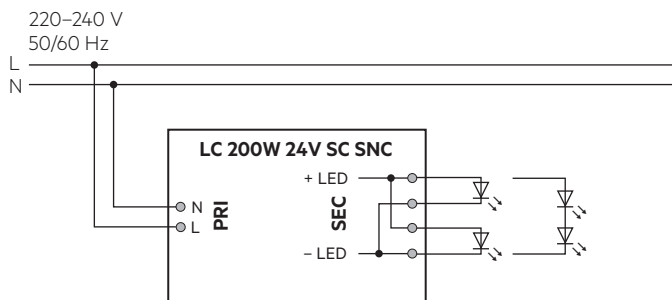

3.2 Wiring type and cross section

The input wiring can be done with a cross section of 0.5 – 1.5 mm². Strip 8.5 – 9.5 mm of insulation from the cables to ensure perfect operation of the push-wire terminals.

The output wiring can be stranded wires with ferrules with a cross section of 0.5 – 1.5 mm² or with solid wires with a cross section of 0.5 – 2.5 mm². Strip 9 – 10 mm of insulation from the cables to ensure perfect operation of the push-wire terminals.

Input wiring

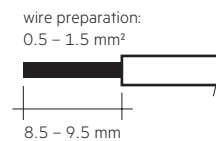

Output wiring

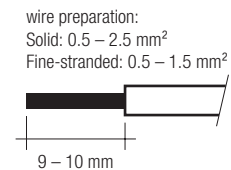

Primary strain relief for cables with bigger cable sheath

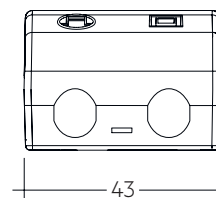

Permissible cable jacket diameter: 2.2 – 9 mm

Secondary strain relief for cable with smaller cable sheath

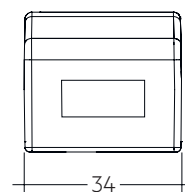

Permissible cable jacket diameter: 3 – 9 mm

3.3 Release of the wiring

Press down the "push button" and remove the cable from front.

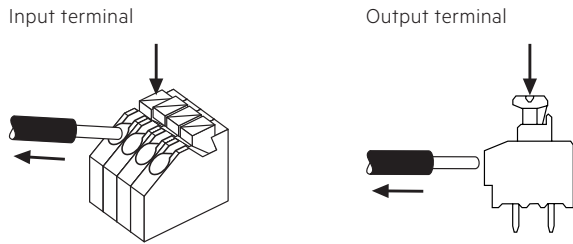

3.4 Fixing conditions when using as independent Driver with Clip-On

Dry, acidfree, oilfree, fatfree. It is not allowed to exceed the maximum ambient temperature (t_a) stated on the device. Minimum distances stated below are recommendations and depend on the actual luminaire. Is not suitable for fixing in corner.

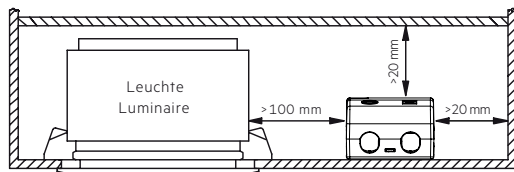

3.5 Wiring guidelines

- The cables should be run separately from the mains connections and mains cables to ensure good EMC conditions.
- The LED wiring should be kept as short as possible to ensure good EMC. The typical secondary cable length is 0.8 m (1.6 m circuit).
- To comply with the EMC regulations run the secondary wires (LED module) in parallel.
- The LED driver has no inverse-polarity protection on the secondary side. Wrong polarity can damage LED modules with no inverse-polarity protection.
- Secondary switching is not permitted.
- Wrong wiring of the LED driver can lead to malfunction or irreparable damage.
- To avoid the damage of the Driver, the wiring must be protected against short circuits to earth (sharp edged metal parts, metal cable clips, louver, etc.).

3.6 Installation instructions

The LED module and all contact points within the wiring must be sufficiently insulated against 3 kV surge voltage. Air and creepage distance must be maintained.

4. Electrical values

4.1 Efficiency vs. load

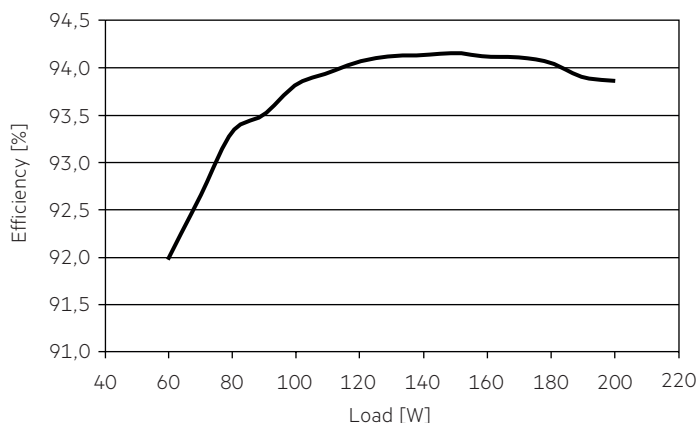

4.2 Power factor vs. Load

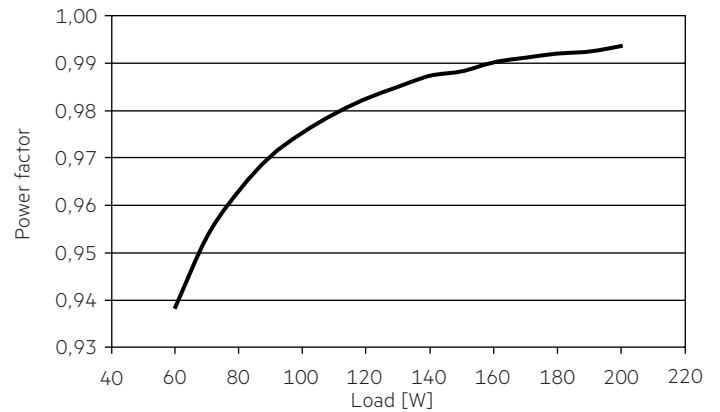

4.3 Input power vs. Load

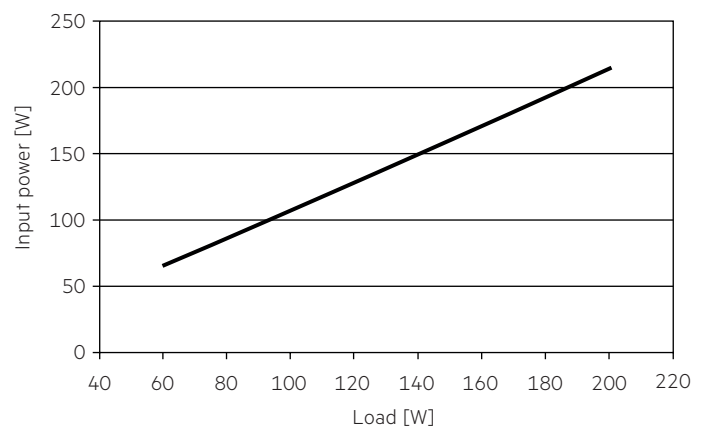

4.4 Input current vs. Load

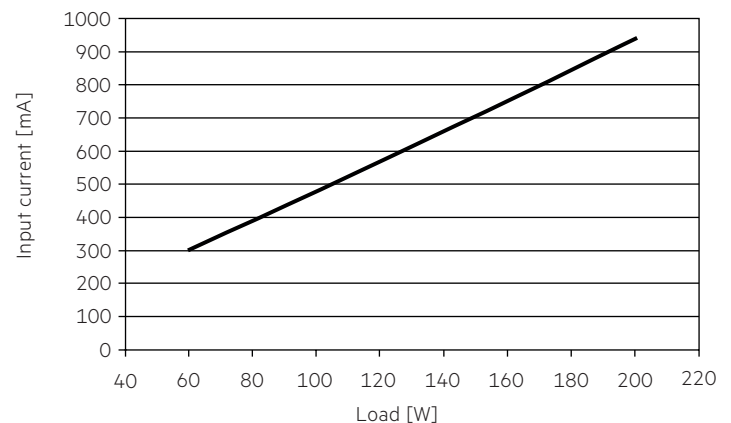

4.5 THD vs. Load

THD without harmonic < 5 mA (0.6 %) of the input current:

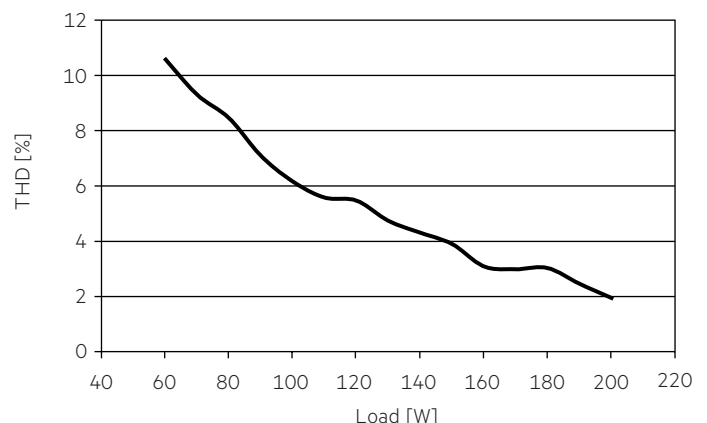

4.6 Maximum loading of automatic circuit breakers in relation to inrush current

Automatic circuit breaker type	C10	C13	C16	C20	B10	B13	B16	B20	Inrush current	
Installation Ø	1.5 mm ²	1.5 mm ²	2.5 mm ²	2.5 mm ²	1.5 mm ²	1.5 mm ²	2.5 mm ²	2.5 mm ²	I_{max}	time
LC 200W 24V SC SNC	10	13	17	22	6	8	10	13	125 A	121 µs

These are max. values calculated out of inrush current! Please consider not to exceed the maximum rated continuous current of the circuit breaker. Calculation uses typical values from ABB series S200 as a reference. Actual values may differ due to used circuit breaker types and installation environment.

4.7 Harmonic distortion in the mains supply (at 230 V / 50 Hz and full load) in %

	THD	3.	5.	7.	9.	11.
LC 200W 24V SC SNC	< 5	< 3	< 2	< 2	< 2	< 2

Acc. to 6100-3-2. Harmonics < 5 mA or < 0.6 % (whatever is greater) of the input current are not considered for calculation of THD.

5. Functions

5.1 Overload protection

If the maximum load is exceeded by a defined internal limit, the LED will flicker, and output voltage will be reduced. When fault is removed, the driver can go back to work automatically without resetting input main power.

5.2 Overtemperature protection

The LED driver is protected against temporary thermal overheating. If the temperature limit is exceeded the LED will flicker, and restart automatically after the driver cold down. The temperature protection is activated approx. + 15 °C above T_c max.

5.3 Short-circuit behaviour

In case of a short circuit at the LED output the LED output is switched off. When fault is removed, the driver can go back to work automatically without resetting input main power.

5.4 No-load operation

The LED driver will not be damaged in the no-load operation. When the output is floating and doesn't connect the LED modules, the output voltage will keep the max. voltage (< 25 V). After connecting the LED load, the driver works normally without resetting the main power.

5.5 Hot plug-in

Hot plug-in is supported. If a LED load is connected, the device does not need to be restarted before the output will be activated again.

5.6 Use of PWM dimmers

PWM dimmers are used to dim the attached LED module. For fulfilling the ecodesign requirements of the European Union following has to be considered:

- Going to stand-by via PWM dimmer is not supported.
- To turn off the luminaire, mains has to be off.

6. Miscellaneous

6.1 Insulation and electric strength testing of luminaires

Electronic devices can be damaged by high voltage. This has to be considered during the routine testing of the luminaires in production.

According to IEC 60598-1 Annex Q (informative only!) or ENEC 303-Annex A, each luminaire should be submitted to an insulation test with 500 V_{DC} for 1 second. This test voltage should be connected between the interconnected phase and neutral terminals and the earth terminal. The insulation resistance must be at least 2 MΩ.

As an alternative, IEC 60598-1 Annex Q describes a test of the electrical strength with 1500 V_{AC} (or 1.414 x 1500 V_{DC}). To avoid damage to the electronic devices this test must not be conducted.

6.2 Conditions of use and storage

Humidity: 5 % up to max. 85 %, not condensed (max. 56 days/year at 85 %)

Storage temperature: -40 °C up to max. +80 °C

The devices have to be acclimatised to the specified temperature range (t_a) before they can be operated.

The LED driver is declared as inbuilt LED controlgear, meaning it is intended to be used within a luminaire enclosure.

If the product is used outside a luminaire, the installation must provide suitable protection for people and environment (e.g. in illuminated ceilings).

6.3 Maximum number of switching cycles

All LED driver are tested with 50,000 switching cycles.

6.4 Additional information

Additional technical information at www.tridonic.com → Technical Data

Lifetime declarations are informative and represent no warranty claim. No warranty if device was opened.

X-ON Electronics

Largest Supplier of Electrical and Electronic Components

Click to view similar products for [LED Power Supplies](#) category:

Click to view products by [Tridonic](#) manufacturer:

Other Similar products are found below :

[PIFC-K250F](#) [PITB-K222A](#) [AC-A60VD24H2.5](#) [ALD-514012PJ134](#) [LB240S24KH](#) [PDA006A-700B](#) [ESS015W-1000-12](#) [EUG-200S210DT](#)
[ESS030W-0900-32](#) [BPOXL 4-12-035](#) [ESS010W-0180-42](#) [ESS010W-0350-24](#) [ESS010W-0200-42](#) [ESM060W-1400-42](#) [PDA080B-1A0G](#)
[ESS010W-0500-12](#) [PDA150B-S1A5G](#) [SLM140W-1.05-130-ZA](#) [ESS015W-0700-18](#) [EUD-150S350DVA](#) [LWA320-C420-ARK-B](#) [HVG-240-48AB](#) [HVG-320-36AB](#) [HVG-320-54AB](#) [DAL50W-0850-56-T](#) [DAL30W-0600-42-T](#) [HVG-320-48AB](#) [CNB50W-1200-42-CAS](#) [CNB30W-0600-42-CAS](#) [87500757](#) [I-SELECT 2 PLUG 900MA BL](#) [I-SELECT 2 PLUG 1200MA BL](#) [LCU 48V 75W DC-STR FO](#) [I-SELECT 2 PLUG 200MA BL](#) [I-SELECT 2 PLUG 525MA BL](#) [LC 45 W 500-1400 MA FLEXC SC EXC](#) [I-SELECT 2 PLUG 325MA BL](#) [I-SELECT 2 PLUG 1500MA BL](#) [I-SELECT 2 PLUG 1600MA BL](#) [LC 50/200-350/170 FLEXCC LP SNC3](#) [LCO 14/100-500/38 O4A NF C EXC3](#) [LC 28W 300-700MA 42 FLEXC NF SC EXC3](#) [LC 44/1050/42 FIXC SRL ADV2](#) [LCA 60W 900-1750MA ONE4ALL C PRE](#) [LC 8/180/44 FIXC SR SNC2](#) [LC 60W 900-1750MA FLEXC SR EXC](#) [LC 19/200-350/54 FLEXC LP SNC4](#) [BXDR-PS-75BS-E116D-01-A](#) [LC 30/500/54 FIXC SR SNC2](#)
[LCA 60W 24V ONE4ALL SC PRE SP](#)