

**Driver LC 25W 350-600mA  $\phi$ 4a T EXC3**

excite in-track series



Black (RAL 9005)



Grey (RAL 7035)



White (RAL 9010)

**Product description**

- \_ Dimmable constant current / in-track LED driver
- \_ Optional accessory ACU ALU NIPPLE M10x1 for mounting the luminaire head
- \_ Compatible with Global Trac PULSE from Nordic Aluminum and OneTrack from Stucchi, see data sheet chapter 3.8
- \_ Dimming range 1 to 100 % (min. 3.5 mA)
- \_ For luminaires of protection class II
- \_ Temperature protection as per EN 61347-2-13 C5e
- \_ Adjustable output current between 350 and 600 mA via I-SELECT 2 plugs or DALI
- \_ Max. output power 25 W
- \_ Up to 83 % efficiency
- \_ Power input on stand-by < 0.5 W
- \_ Nominal lifetime up to 100,000 h
- \_ 5 years guarantee (conditions at [www.tridonic.com](http://www.tridonic.com))

**Housing properties**

- \_ Casing: polycarbonate, black, white or grey
- \_ Type of protection IP20

**Interfaces**

- \_ one4all (DALI-2, switchDIM, corridorFUNCTION)
- \_ Terminal blocks: 45° push terminals

**Functions**

- \_ Adjustable output current in 1-mA-steps (DALI-2, I-SELECT 2)
- \_ Overtemperature protection
- \_ Overload protection
- \_ Short-circuit protection
- \_ No-load protection
- \_ Burst protection voltage 2 kV
- \_ Surge protection voltage 1 kV (L to N)

**Benefits**

- \_ Flexible configuration via companionSUITE (DALI-2)

**Typical applications**

- \_ For spot light in retail and hospitality application

**Website**

<http://www.tridonic.com/87500908>



Spotlights



Downlights



Linear



Area



Floor | Wall



Free-standing



Street



Decorative



High bay

## Driver LC 25W 350-600mA o4a T EXC3

excite in-track series

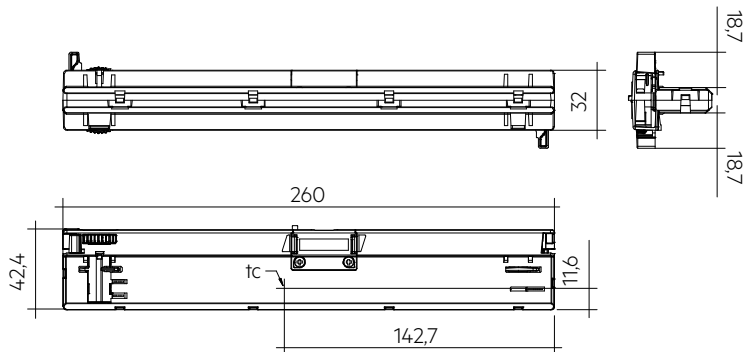

## Ordering data

Type	Article number	Colour	Packaging, carton	Packaging, low volume	Packaging, high volume	Weight per pc.
LC 25/350-600/42 o4a T-B EXC3	87500908	Black	10 pc(s).	130 pc(s).	1,170 pc(s).	0.165 kg
LC 25/350-600/42 o4a T-W EXC3	87500909	White	10 pc(s).	130 pc(s).	1,170 pc(s).	0.165 kg
LC 25/350-600/42 o4a T-G EXC3	87500910	Grey	10 pc(s).	130 pc(s).	1,170 pc(s).	0.165 kg

## Technical data

Rated supply voltage	220 – 240 V
AC voltage range	198 – 264 V
Max. input current (at 230 V, 50 Hz, full load)	0.13 A
Leakage current (at 230 V, 50 Hz, full load)	< 700 µA
Mains frequency	50 / 60 Hz
Overvoltage protection	320 V AC, 48 h
Max. input power	29.6 W
Typ. power consumption (at 230 V, 50 Hz, full load) <sup>①</sup>	29.7 W
Min. output power	0.049 W
Max. output power	25 W
Typ. power consumption on stand-by <sup>②</sup>	< 0.5 W
Typ. efficiency (at 230 V, 50 Hz, full load) <sup>①</sup>	83 %
λ (at 230 V, 50 Hz, full load) <sup>①</sup>	0.95
Output current tolerance <sup>③</sup>	± 5 %
Max. output current peak <sup>④</sup>	≤ output current + 20 %
Max. output voltage (U-OUT)	60 V
THD (at 230 V, 50 Hz, full load) <sup>①</sup>	< 10 %
Output LF current ripple (< 120 Hz)	± 3 %
Output P_ST_LM (at full load)	≤ 1
Output SVM (at full load)	≤ 0.4
Starting time (at 230 V, 50 Hz, full load)	< 0.66 s
Turn off time (at 230 V, 50 Hz, full load)	≤ 0.03 s
Hold on time at power failure (output)	0 s
Dimming range	1 – 100 % (min. 3.5 mA)
Ambient temperature t <sub>a</sub> (at lifetime 100,000 h)	25 °C
Storage temperature t <sub>s</sub>	-40 ... +80 °C
Mains surge capability (between L - N)	1 kV
Lifetime	up to 100,000 h
Guarantee (conditions at <a href="http://www.tridonic.com">www.tridonic.com</a> )	5 Year(s)
Dimensions L x W x H	260 x 32 x 42.4 mm

## Approval marks



## Standards

EN 55015, EN 61000-3-2, EN 61000-3-3, EN 61347-1, EN 61347-2-13, EN 61547, EN 62384

## Specific technical data

Type	Output current <sup>①</sup>	Min. output voltage <sup>②</sup>	Max. output voltage	Max. output power	Typ. power consumption (at 230 V, 50 Hz, full load)	Typ. current consumption (at 230 V, 50 Hz, full load)	t <sub>c</sub> point max.	Ambient temperature T <sub>a</sub>	I-SELECT 2 resistor value <sup>⑥</sup>
LC 25/350-600/42 o4a T-B EXC3	350 mA	14 V	42.0 V	14.7 W	18.0 W	81 mA	70 °C	-20 ... +35 °C	-
LC 25/350-600/42 o4a T-B EXC3	400 mA	14 V	42.0 V	16.8 W	20.3 W	91 mA	70 °C	-20 ... +35 °C	12.5 kΩ
LC 25/350-600/42 o4a T-B EXC3	450 mA	14 V	42.0 V	18.9 W	22.6 W	101 mA	70 °C	-20 ... +35 °C	11.1 kΩ
LC 25/350-600/42 o4a T-B EXC3	500 mA	14 V	42.0 V	21.0 W	24.9 W	110 mA	70 °C	-20 ... +35 °C	10.0 kΩ
LC 25/350-600/42 o4a T-B EXC3	550 mA	14 V	42.0 V	23.1 W	27.3 W	121 mA	70 °C	-20 ... +35 °C	9.1 kΩ
LC 25/350-600/42 o4a T-B EXC3	600 mA	14 V	41.7 V	25.0 W	29.7 W	130 mA	70 °C	-20 ... +35 °C	0.0 kΩ
LC 25/350-600/42 o4a T-W EXC3	350 mA	14 V	42.0 V	14.7 W	18.0 W	81 mA	70 °C	-20 ... +35 °C	-
LC 25/350-600/42 o4a T-W EXC3	400 mA	14 V	42.0 V	16.8 W	20.3 W	91 mA	70 °C	-20 ... +35 °C	12.5 kΩ
LC 25/350-600/42 o4a T-W EXC3	450 mA	14 V	42.0 V	18.9 W	22.6 W	101 mA	70 °C	-20 ... +35 °C	11.1 kΩ
LC 25/350-600/42 o4a T-W EXC3	500 mA	14 V	42.0 V	21.0 W	24.9 W	110 mA	70 °C	-20 ... +35 °C	10.0 kΩ
LC 25/350-600/42 o4a T-W EXC3	550 mA	14 V	42.0 V	23.1 W	27.3 W	121 mA	70 °C	-20 ... +35 °C	9.1 kΩ
LC 25/350-600/42 o4a T-W EXC3	600 mA	14 V	41.7 V	25.0 W	29.7 W	130 mA	70 °C	-20 ... +35 °C	0.0 kΩ
LC 25/350-600/42 o4a T-G EXC3	350 mA	14 V	42.0 V	14.7 W	18.0 W	81 mA	70 °C	-20 ... +35 °C	-
LC 25/350-600/42 o4a T-G EXC3	400 mA	14 V	42.0 V	16.8 W	20.3 W	91 mA	70 °C	-20 ... +35 °C	12.5 kΩ
LC 25/350-600/42 o4a T-G EXC3	450 mA	14 V	42.0 V	18.9 W	22.6 W	101 mA	70 °C	-20 ... +35 °C	11.1 kΩ
LC 25/350-600/42 o4a T-G EXC3	500 mA	14 V	42.0 V	21.0 W	24.9 W	110 mA	70 °C	-20 ... +35 °C	10.0 kΩ
LC 25/350-600/42 o4a T-G EXC3	550 mA	14 V	42.0 V	23.1 W	27.3 W	121 mA	70 °C	-20 ... +35 °C	9.1 kΩ
LC 25/350-600/42 o4a T-G EXC3	600 mA	14 V	41.7 V	25.0 W	29.7 W	130 mA	70 °C	-20 ... +35 °C	0.0 kΩ

① Test result at 600 mA.

② Depending on the DALI traffic at the interface.

③ Output current is mean value.

④ Test result at 25 °C.

⑤ Device operates down to 4 V output voltage. It cannot be guaranteed that harmonics and EMI stay inside the limits. This has to be checked individually.

⑥ Not compatible with I-SELECT (generation 1). Calculated resistor value.

## I-SELECT 2 PLUG PRE / EXC

Accessory

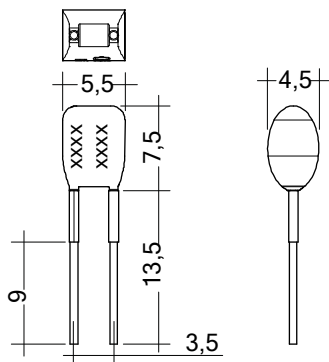
**Product description**

- \_ Ready-for-use resistor to set output current value
- \_ Compatible with LED driver featuring I-select 2 interface; not compatible with I-SELECT (generation 1)
- \_ Resistor is base insulated
- \_ Resistor power 0.25 W
- \_ Current tolerance  $\pm 2\%$  additional to output current tolerance
- \_ Compatible with LED driver series PRE and EXC

**Example of calculation**

- \_  $R [k\Omega] = 5 V / I_{out} [mA] \times 1000$
- \_ E96 resistor value used
- \_ Resistor value tolerance  $\leq 1\%$ ; resistor power  $\geq 0.1 W$ ; base insulation necessary
- \_ When using a resistor value beyond the specified range, the output current will automatically be set to the minimum value (resistor value too big), respectively to the maximum value (resistor value too small)

**Website**

<http://www.tridonic.com/28001111>

**Ordering data**

Type	Article number	Colour	Marking	Current	Resistor value	Packaging, bag	Weight per pc.
I-SELECT 2 PLUG 375MA BL	28001111	Blue	0375 mA	375 mA	13.30 k $\Omega$	10 pc(s).	0.001 kg
I-SELECT 2 PLUG 400MA BL	28001112	Blue	0400 mA	400 mA	12.40 k $\Omega$	10 pc(s).	0.001 kg
I-SELECT 2 PLUG 425MA BL	28001251	Blue	0425 mA	425 mA	11.80 k $\Omega$	10 pc(s).	0.001 kg
I-SELECT 2 PLUG 450MA BL	28001113	Blue	0450 mA	450 mA	11.00 k $\Omega$	10 pc(s).	0.001 kg
I-SELECT 2 PLUG 475MA BL	28001252	Blue	0475 mA	475 mA	10.50 k $\Omega$	10 pc(s).	0.001 kg
I-SELECT 2 PLUG 500MA BL	28001114	Blue	0500 mA	500 mA	10.00 k $\Omega$	10 pc(s).	0.001 kg
I-SELECT 2 PLUG 550MA BL	28001115	Blue	0550 mA	550 mA	9.09 k $\Omega$	10 pc(s).	0.001 kg
I-SELECT 2 PLUG MAX BL	28001099	Blue	MAX	MAX	0.00 k $\Omega$	10 pc(s).	0.001 kg

## ACU ALU NIPPLE M10x1

Accessory

**Product description**

- \_ Optional threaded sleeve for luminaire mounting
- \_ Suitable for S-9009/D-M10 threaded nut
- \_ Additional mounting equipment, e.g. M13x1 available at AAG Stucchi (<http://www.aagstucchi.it/en/>)

**Website**

<http://www.tridonic.com/28002398>

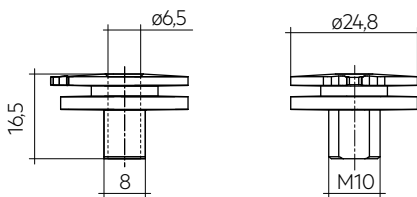
**Ordering data**

Type	Article number	Packaging, bag	Weight per pc.
ACU ALU NIPPLE M10x1	28002398	100 pc(s).	0.007 kg

## 1. Standards

EN 55015  
 EN 61000-3-2  
 EN 61000-3-3  
 EN 61000-4-4  
 EN 61000-4-5  
 EN 61347-1  
 EN 61347-2-13  
 EN 61547  
 EN 62384  
 EN 62386

### 1.1 Glow-wire test

according to EN 61347-1 with increased temperature of 850 °C passed.

## 2. Thermal details and lifetime

### 2.1 Expected lifetime

Expected lifetime			
Type	ta	25 °C	35 °C
LC 25/350-600/42 o4a T EXC3	Lifetime	>100,000 h	100,000 h

<sup>①</sup> Test result at max. output voltage.

The LED drivers are designed for a lifetime stated above under reference conditions and with a failure probability of less than 10 %.

## 3. Installation / wiring

### 3.1 Circuit diagram

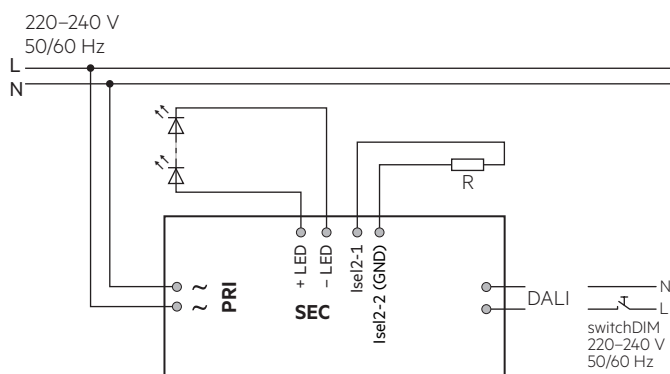

### 3.2 Wiring type and cross section

For wiring use stranded wire with ferrules or solid wire from 0.2–0.5 mm<sup>2</sup>. Strip 8.5–9.5 mm of insulation from the cables to ensure perfect operation of the push-wire terminals.

Use one wire for each terminal connector only.

wire preparation:  
0.2 – 0.5 mm<sup>2</sup>

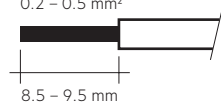

### 3.3 Release of the wiring

Press down the “push button” and remove the cable from front.

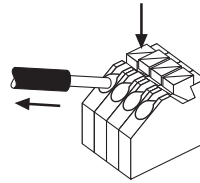

### 3.4 Fixing conditions

Dry, acidfree, oilfree, fatfree. It is not allowed to exceed the maximum ambient temperature (ta) stated on the device.

### 3.5 Wiring guidelines

- All connections must be kept as short as possible to ensure good EMI behaviour.
- Max. length of output wires is 20 cm.
- Secondary switching is not permitted.
- Incorrect wiring can damage LED modules.
- To avoid the damage of the Driver, the wiring must be protected against short circuits to earth (sharp edged metal parts, metal cable clips, louver, etc.).

### 3.6 Replace LED module

1. Mains off
2. Remove LED module
3. Wait for 20 seconds
4. Connect LED module again

Hot plug-in or secondary switching of LEDs is not permitted and may cause a very high current to the LEDs.

### 3.7 Mounting luminaire

Max. allowed weight of complete luminaire: 5 kg (50 N). This is valid for horizontal mounting of track system only. For vertical installation please contact Tridonic for clarification.

### 3.8 Compatible tracks

Subject to be changed without notice.

Manufacturer	Type	System	Intrack casing colour
NORDIC ALUMINIUM	GLOBAL Trac Pulse XTSC 6xxx	3P + DALI	Black, white, grey
NORDIC ALUMINIUM	GLOBAL Trac Pulse XTSCF 6xxx	3P + DALI	Black, white, grey
Stucchi	One track	3P + DALI	Black, white, grey
Powergear	PRO-0610	3P + DALI	Black, white, grey
Unipro	TC32W	3P + DALI	Black, white, grey
Unipro	TC32FW	3P + DALI	Black, white, grey

Tests have been done with in-tracks taken from the market in the first half of 2020.



Tridonic has no control or responsibility on any future or past possible changes made by different manufactures that could affect the compatibility between tracks and adapters.

Please check compatibility of track system with switchDIM or corridorFUNCTION in advance.

### 3.9 Insulation between terminals

Insulation	Mains	-LED / +LED	one4all
Mains	–	double	basic
-LED / +LED	double	–	double
one4all	basic	double	–

basic ... represents basic insulation.

double ... represents double or reinforced insulation.

### 3.10 Adapter mounting into the track

Insert the adapter into the track, so that the mechanical key (A) in the adaptor matches the groove (B) in the track. Rotate of about 90° the lever of the cam (C = mains and D = DALI-2) until it reaches the locking position. To open rotate the lever the opposite direction.

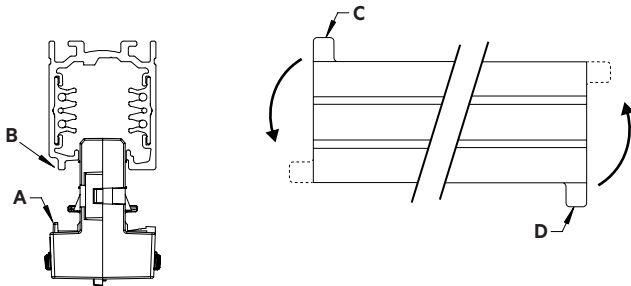

### 3.11 Phase selection

When the track is connected to a three-phase system it is possible to select the phase (L1, L2 or L3) to distribute the single luminaires in the system, by means of the proper selector (A) of the adaptor.

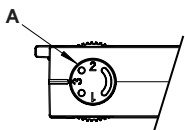

#### 4. Electrical values

##### 4.1 Operating window

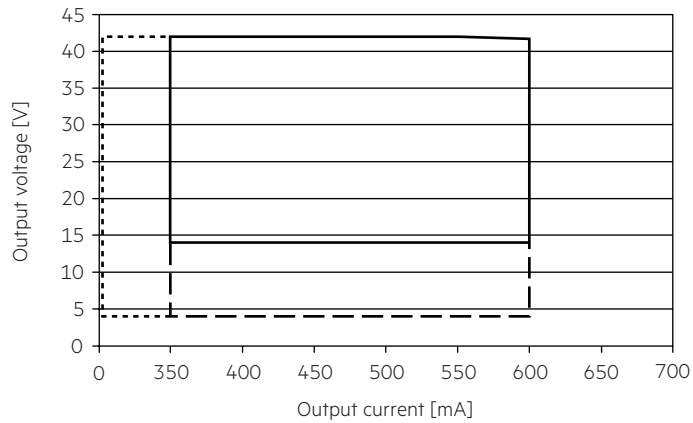

- Operating window
- Operating window dimmed
- - - - Operating window 4 V

Device operates down to 4 V output voltage. It cannot be guaranteed that harmonics and EMI stay inside the limits. This has to be checked individually.

##### 4.2 Efficiency vs load

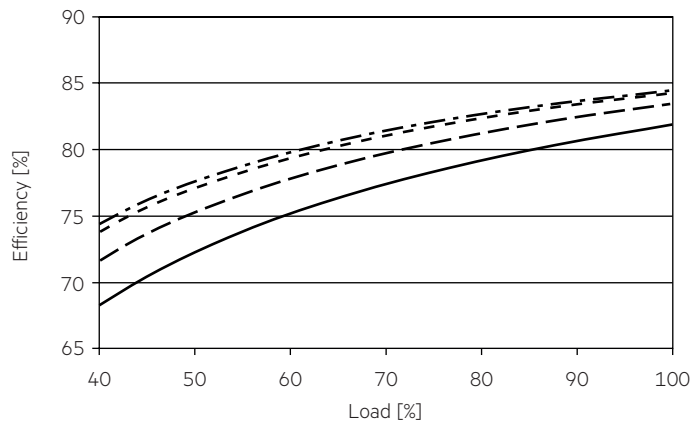

##### 4.3 Power factor vs load

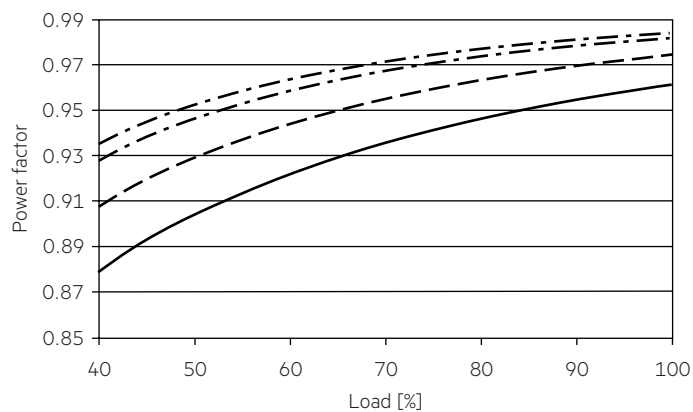

##### 4.4 Input power vs load

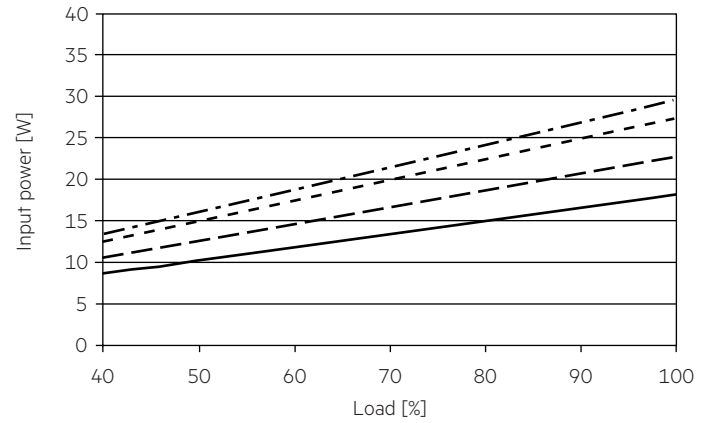

##### 4.5 Input current vs load

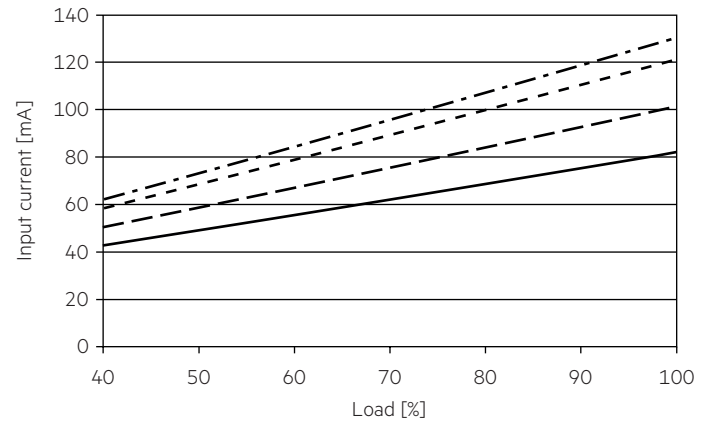

##### 4.6 THD vs load

THD without harmonic < 5 mA (0.6 %) of the input current:

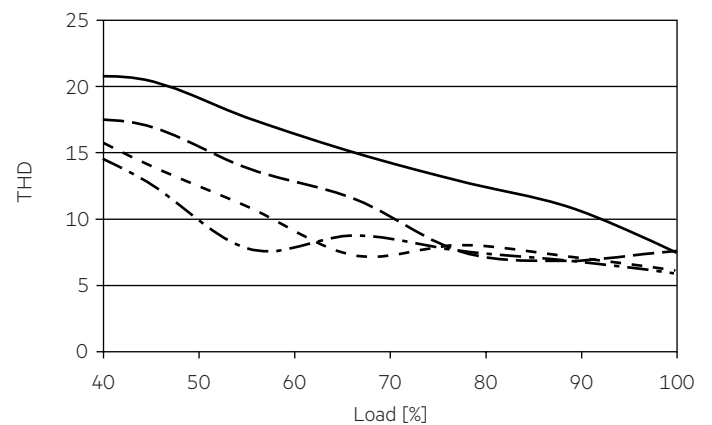

- 350 mA
- - - 450 mA
- · - · 550 mA
- 600 mA



#### 4.7 Maximum loading of automatic circuit breakers in relation to inrush current

Automatic circuit breaker type	C10	C13	C16	C20	B10	B13	B16	B20	Inrush current	
Installation Ø	1.5 mm <sup>2</sup>	1.5 mm <sup>2</sup>	1.5 mm <sup>2</sup>	2.5 mm <sup>2</sup>	1.5 mm <sup>2</sup>	1.5 mm <sup>2</sup>	1.5 mm <sup>2</sup>	2.5 mm <sup>2</sup>	I <sub>max</sub>	Time
<b>LC 25/350-600/42 o4a T EXC3</b>	40	52	64	80	40	52	64	80	9.6 A	34 µs

These are max. values calculated out of continuous current running the device on full load.

There is no limitation due to inrush current.

If load is smaller than full load for calculation only continuous current has to be considered.

#### 4.8 Harmonic distortion in the mains supply (at 230 V / 50 Hz and full load) in %

	THD	3.	5.	7.	9.	11.
<b>LC 25/350-600/42 o4a T EXC3</b>	< 10	< 6	< 5	< 5	< 4	< 3

Acc. to 61000-3-2. Harmonics < 5 mA or < 0.6 % (whatever is greater) of the input current are not considered for calculation of THD.

#### 4.9 Dimming characteristics

Digital dimming value

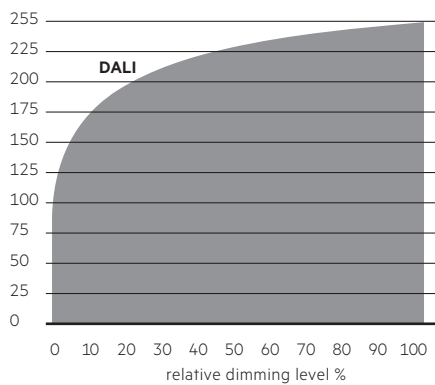

Dimming characteristics as seen by the human eye.

Dimming is realized by amplitude dimming.

## 5. Software / Programming / Interfaces

### 5.1 Software / programming

With appropriate software and interface different functions can be activated and various parameters can be configured in the LED driver. The Driver supports the following software and interface:

Software / hardware for configuration:

- companionSUITE (deviceGENERATOR, deviceCONFIGURATOR, deviceANALYSER)







## 6. Functions

☉ companionSUITE:

DALI-2

The companionSUITE with deviceGENERATOR, deviceCONFIGURATOR and deviceANALYSER is available via our WEB page:

<https://www.tridonic.com/com/en/products/companionsuite.asp>

Icon	Function	DALI-2
	OEM Identification	☉
	OEM GTIN	☉
	LED current	☉
	Device operating mode	☉
	corridorFUNCTION	☉
	Constant light output (CLO)	☉
	Enhanced power on level (ePOL)	☉

### 6.1 LED current



The LED output current must be adapted to the connected LED module. The value is limited by the current range of the respective device.

### 6.2 switchDIM



Integrated switchDIM function allows a direct connection of a pushbutton for dimming and switching.

Brief push (< 0.6 s) switches LED driver ON and OFF. The dimm level is saved at power-down and restored at power-up. When the pushbutton is held, LED modules are dimmed. After repush the LED modules are dimmed in the opposite direction.

In installations with LED drivers with different dimming levels or opposite dimming directions (e.g. after a system extension), all LED drivers can be synchronized to 50 % dimming level by a 10 s push.

Use of pushbutton with indicator lamp is not permitted.

### 6.3 corridorFUNCTION



A motion detector (corridorFUNCTION) can be wired on the DALI track. With the corridorFUNCTION and a commercially available motion detector, it is easy to adapt the lighting in one area to its use.

That is, when the area is entered by a person, the lighting dims instantly to a certain brightness and is available in desired strength. After the area is left by the person, the brightness dims slowly to a smaller value or switches off completely.

The individual parameters of the desired profile, such as brightness values or delay times, can be adjusted flexibly and individually.

To activate the corridorFUNCTION without using software a voltage of 230 V has to be applied at the DALI track.

The unit will then switch automatically to the corridorFUNCTION.

corridorFUNCTION is a very simple tool for controlling gears with conventional pushbuttons or motion sensors.

To ensure correct operation a sinusoidal mains voltage with a frequency of 50 Hz or 60 Hz is required at the control input.

Special attention must be paid to achieving clear zero crossings.

Serious mains faults may impair the operation of corridorFUNCTION.

Note:

By using corridorFUNCTION programming and monitoring via DALI is always possible.

### 6.4 Constant Light Output (CLO)



With this function the light output of the LED module can be kept equal over the lifetime.

The light output of an LED module reduces over the course of its lifetime.

The Constant Light Output (CLO) function compensates for this natural decline by constantly increasing the output current of the LED driver throughout its lifetime.

CLO shall be achieved by limitation of the LED current at the commissioning of the LED driver and providing a linear interpolation of the current over the time, depending on the data points given by the user.

The user has to insert up to eight pairs of data (time, level).

The output curve is the result of connecting the user data points linear.

Detailed description for CLO see product manual.

## 6.5 Enhanced power on level (ePOL)



The Enhanced Power On Level parameter defines the power level that is set automatically when power is restored after a power failure.

Detailed description for ePOL see product manual.

## 7. Functions

### 7.1 Short-circuit behaviour

In case of a short circuit on the secondary side (LED) the LED driver switches off. After elimination of the short-circuit fault the LED driver will recover automatically.

### 7.2 No-load operation

The LED driver works in burst working mode to provide a constant output voltage regulation which allows the application to be able to work safely when LED string opens due to a failure.

### 7.3 Overload protection

If the maximum load is exceeded by a defined internal limit, the LED driver will protect itself and LED may flicker. After elimination of the overload the nominal operation will recover automatically.

### 7.4 Overtemperature protection

The LED driver is protected against temporary thermal overheating. If the temperature limit is exceeded the LED driver will switch off. It restarts automatically.

The temperature protection is activated above  $t_{c\ max}$ .

### 7.5 Function: adjustable current

The output current of the LED driver can be adjusted in a certain range.

#### I-SELECT 2

By inserting a suitable resistor or third party resistor into the I-SELECT 2 interface, the current value can be adjusted. The relationship between output current and resistor value can be found in the chapter "Accessories I-SELECT 2 Plugs".



Please note that the resistor values for I-SELECT 2 are not compatible with I-SELECT (generation 1). Installation of an incorrect resistor may cause irreparable damage to the LED module(s).

Resistors for the main output current values can be ordered from Tridonic (see accessories).

## 8. Miscellaneous

### 8.1 Insulation and electric strength testing of luminaires

Electronic devices can be damaged by high voltage. This has to be considered during the routine testing of the luminaires in production.

According to IEC 60598-1 Annex Q (informative only!) or ENEC 303-Annex A, each luminaire should be submitted to an insulation test with 500 V<sub>DC</sub> for 1 second. This test voltage should be connected between the interconnected phase and neutral terminals and the earth terminal.

The insulation resistance must be at least 2 MΩ.

As an alternative, IEC 60598-1 Annex Q describes a test of the electrical strength with 1500 V<sub>AC</sub> (or 1.414 x 1500 V<sub>DC</sub>). To avoid damage to the electronic devices this test must not be conducted.

The equipotential terminal is used to connect the heat sink and the LED driver to reduce transients.

### 8.2 Conditions of use and storage

Humidity: 5% up to max. 85%,  
not condensed  
(max. 56 days/year at 85%)

Storage temperature: -40 °C up to max. +80 °C

The devices have to be acclimatised to the specified temperature range (ta) before they can be operated.

### 8.3 Maximum number of switching cycles

All LED driver are tested with 50,000 switching cycles. The actually achieved number of switching cycles is significantly higher.

### 8.4 Additional information

Additional technical information at [www.tridonic.com](http://www.tridonic.com) → Technical Data

Lifetime declarations are informative and represent no warranty claim. No warranty if device was opened.

## X-ON Electronics

Largest Supplier of Electrical and Electronic Components

*Click to view similar products for [LED Power Supplies](#) category:*

*Click to view products by [Tridonic](#) manufacturer:*

Other Similar products are found below :

[PIFC-K250F](#) [PITB-K222A](#) [AC-A60VD24H2.5](#) [ALD-514012PJ134](#) [PWD-60-1-70-P](#) [EUG-200S210DT](#) [ESS030W-1050-21](#) [BPOXL 4-12-035](#) [ESS010W-0180-42](#) [ESS010W-0350-24](#) [ESS010W-0200-42](#) [SLM140W-1.05-130-ZA](#) [ESS015W-0700-18](#) [HVG-240-48AB](#) [HVG-240-54AB](#) [OTE 25/220-240/700 PC](#) [DAL30W-0600-42-T](#) [HVG-320-48AB](#) [CNB30W-0600-42-CAS](#) [87500757](#) [I-SELECT 2 PLUG 2100MA BL](#) [LCU 48V 75W DC-STR FO](#) [LC 45 W 500-1400 MA FLEXC SC EXC](#) [I-SELECT 2 PLUG 2000MA BL](#) [LC 50/200-350/170 FLEXCC LP](#) [SNC3](#) [LCO 14/100-500/38 O4A NF C EXC3](#) [LC 28W 300-700MA 42 FLEXC NF SC EXC3](#) [LC 44/1050/42 FIXC SRL ADV2](#) [LCA 60W 900-1750MA ONE4ALL C PRE](#) [LC 8/180/44 FIXC SR SNC2](#) [LC 19/200-350/54 FLEXC LP SNC4](#) [BXDR-PS-75BS-E116D-01-A](#) [LC 30/500/54 FIXC SR SNC2](#) [LCA 60W 24V ONE4ALL SC PRE SP](#) [LC 60W 75-330MA 310V FLEXC NF H16 EXC4](#) [LC 8/180/42 FIXC PC SR SNC2](#) [LC 10/350/29 FIXC SR SNC2](#) [LC 25/500/43 FIXC SR SNC2](#) [LC 50/100-400/140 PO4A NF H16 PRE3](#) [LC 25/600/42 FIXC SRL ADV2](#) [LCO 24/200-1050/39 NF C ADV3](#) [ELEMENT 35/220...240/900 G3](#) [LC 25W 350-1050MA FLEXC SR EXC](#) [LC 60/700/86 FIXC SR SNC2](#) [LC 35W 24 ONE4ALL IP PRE](#) [BXDR-PS-25BS-E107D-01-A](#) [LC 17W 250-700MA FLEXC SR EXC](#) [LC 15W 350MA FIXC C SNC](#) [LC 14W 700MA FIXC PC SR SNC2](#) [LC 200W 24V SC SNC](#)