



Driver LC 34W 800mA fixC SRL ADV2
advanced series

Product description

- Independent constant current LED driver with strain-relief
- Extra flat housing for constrained installation conditions (small ceiling cut outs and low ceiling voids)
- For luminaires of protection class II
- For luminaires with M and MM as per EN 60598, VDE 0710 and VDE 0711
- Temperature protection as per EN 61347-2-13 C5e
- Output current 800 mA
- Max. output power 33.6 W
- Nominal lifetime up to 50,000 h
- 5 years guarantee (conditions at www.tridonic.com)



Housing properties

- Casing: polycarbonat, white
- Type of protection IP20
- Push-in terminals
- Strain relief with loop through function
- 2 separable strain relief parts for input and output cables with highly robust clamps
- New strain relief concept – fast mounting and pre-assembled connection of the LED load possible

Functions

- Overload protection
- Short-circuit protection
- No-load protection
- No output current overshoot at mains on/off

Typical applications

- For downlight in retail and hospitality application
- For panel light and area light in office and education application



Standards, page 3

Wiring diagrams and installation examples, page 3

IP20 SELV

RoHS

Driver 34W 800mA fixC SRL ADV2

advanced series

Technical data

Rated supply voltage	220 – 240 V
AC voltage range	198 – 264 V
Mains frequency	50 / 60 Hz
Overvoltage protection	320 V AC, 1 h
THD (at 230 V, 50 Hz, full load)	< 10 %
Output current tolerance [®]	± 7.5 %
Typ. output LF current ripple at full load [®]	± 5 %
Output P_{STLM} (at full load)	≤ 1
Output SVM (at full load)	≤ 0.4
Starting time (at 230 V, 50 Hz, full load)	≤ 0.5 s
Turn off time (at 230 V, 50 Hz, full load)	≤ 0.5 s
Hold on time at power failure (output)	0 s
Ambient temperature t_a	-20 ... +50 °C
Ambient temperature t_a (at lifetime 50,000 h)	50 °C
Storage temperature t_s	-40 ... +80 °C
Mains burst capability	1 kV
Mains surge capability (between L – N)	1 kV
Mains surge capability (between L/N – PE)	2 kV
Surge voltage at output side (against PE)	2 kV
Lifetime	up to 50,000 h
Guarantee (conditions at www.tridonic.com)	5 years
Dimensions L x W x H	147 x 43 x 30 mm

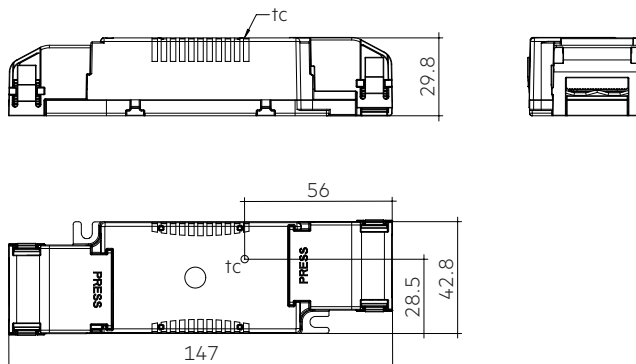

Ordering data

Type	Article number	Packaging, carton	Packaging, low volume	Packaging, high volume	Weight per pc.
LC 34/800/42 fixC SRL ADV2	87500958	10 pc(s).	80 pc(s).	1,200 pc(s).	0.104 kg

Specific technical data

Type	Output current [®]	Input current (at 230 V, 50 Hz, full load)	Max. input power	Input power (at 230 V, 50 Hz, full load)	Output power range	λ at full load [®]	Efficiency at full load [®]	λ at min. load [®]	Efficiency at min. load [®]	Min. forward voltage	Max. forward voltage	Max. output voltage	Max. output peak current at full load [®]	Max. output peak current at min. load [®]	Max. casing temperature t_c
LC 34/800/42 fixC SRL ADV2	800 mA	170 mA	39 W	38 W	24.0 – 33.6 W	0.96	89 %	0.94C	87 %	30 V	42 V	60 V	900 mA	900 mA	75 °C

[®] Test result at 230 V, 50 Hz.

[®] The trend between min. and full load is linear and depends on load's voltage-current character.

[®] Output current is mean value.

[®] Typical value at full load, depends on load's voltage-current character.

1. Standards

EN 55015
EN 61000-3-2
EN 61000-3-3
EN 61347-1
EN 61347-2-13
EN 61547
EN 60598-1
EN 62384

1.1 Glow-wire test

according to EN 61347-1 with increased temperature of 850 °C passed.

2. Thermal details and lifetime

2.1 Expected lifetime

Expected lifetime			
Type	t_a	40 °C	50 °C
LC 34/800/42 fixC SRL ADV2	t_c	65 °C [Ⓟ]	75 °C [Ⓟ]
	Lifetime	100,000 h	50,000 h

[Ⓟ] Test result at max. output voltage.

The LED drivers are designed for a lifetime stated above under reference conditions and with a failure probability of less than 10 %.

The relation of t_c to t_a temperature depends also on the luminaire design. If the measured t_c temperature is approx. 5 K below t_c max., t_a temperature should be checked and eventually critical components (e.g. ELCAP) measured. Detailed information on request.

3. Installation / wiring

3.1 Circuit diagram

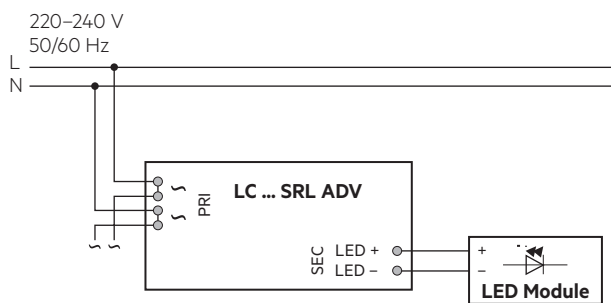

Device with loop through wiring function.

3.2 Wiring type and cross section

For wiring use stranded wire with ferrules or solid wire from 0.75–1.5 mm² (mains wires) and 0.2–1.5 mm² (secondary wires, LED module). Strip 8.5–9.5 mm of insulation from the cables to ensure perfect operation of the push-wire terminals.

Use one wire for each terminal connector only.

Input terminal (D2):

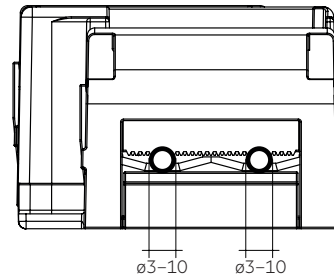
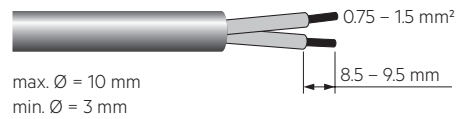

Output terminal (D1):

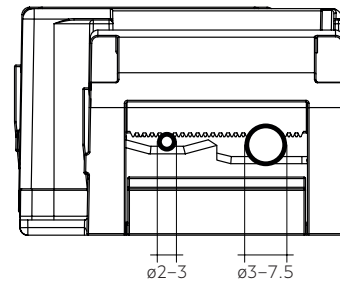
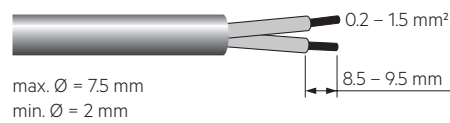

3.3 Release of the wiring

Press down the “push button” and remove the cable from front.

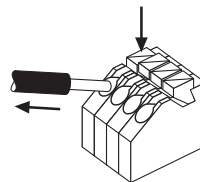

3.4 Fixing conditions when using as independent Driver with Clip-On

Dry, acidfree, oilfree, fatfree. It is not allowed to exceed the maximum ambient temperature (t_a) stated on the device. Minimum distances stated below are recommendations and depend on the actual luminaire. Is not suitable for fixing in corner.

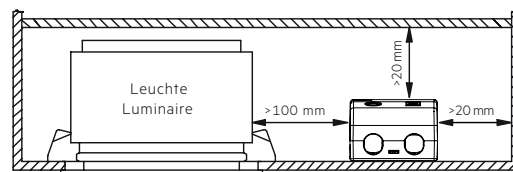

3.5 Wiring guidelines

- All connections must be kept as short as possible to ensure good EMI behaviour.
- Mains leads should be kept apart from LED driver and other leads (ideally 5 – 10 cm distance)
- Max. length of output wires is 2 m.
- To comply with the EMC regulations run the secondary wires (LED module) in parallel.
- Secondary switching is not permitted.
- Incorrect wiring can damage LED modules.
- Through wiring of mains is for connecting additional LED driver only. Max. permanent current of 8 A may not be exceeded.
- To avoid the damage of the Driver, the wiring must be protected against short circuits to earth (sharp edged metal parts, metal cable clips, louver, etc.).

3.6 Replace LED module

1. Mains off
2. Remove LED module
3. Wait for 20 seconds
4. Connect LED module again

Hot plug-in or secondary switching of LEDs is not permitted and may cause a very high current to the LEDs.

3.7 Installation instructions

The LED module and all contact points within the wiring must be sufficiently insulated against 3 kV surge voltage.
Air and creepage distance must be maintained.

3.8 Mounting of device

Max. torque for fixing: 0.5 Nm/M4

4. Electrical values

4.1 Diagrams

4.1.1 Efficiency vs load

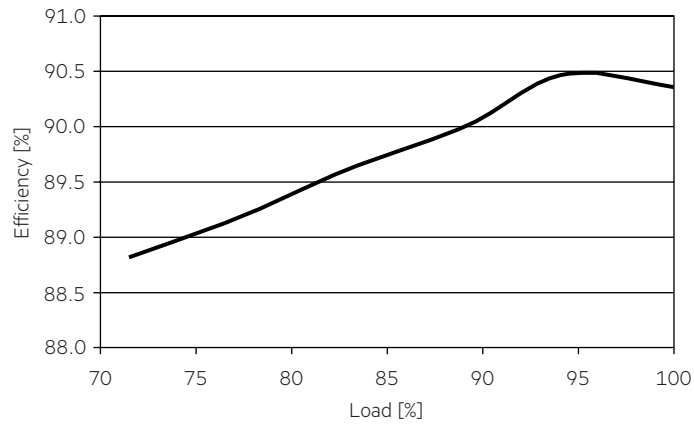

4.1.4 Input current vs load

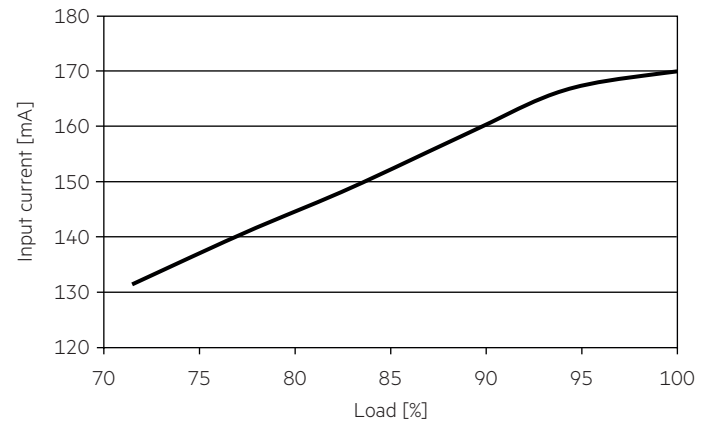

4.1.2 Power factor vs load

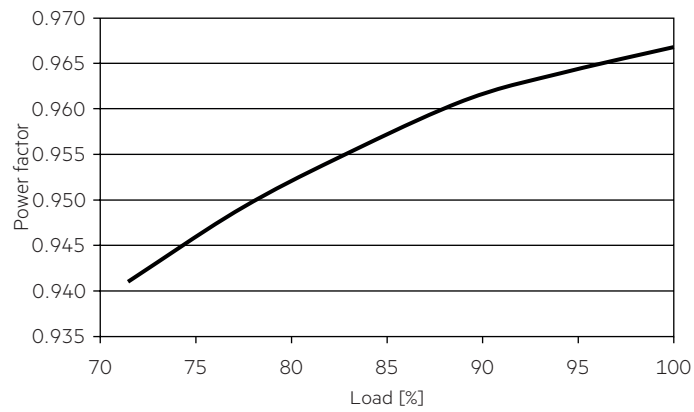

4.1.5 THD vs load

THD without harmonic < 5 mA (0.6 %) of the input current:

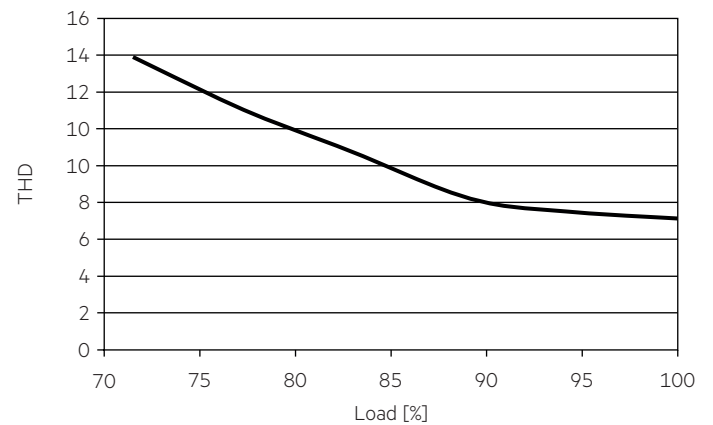

4.1.3 Input power vs load

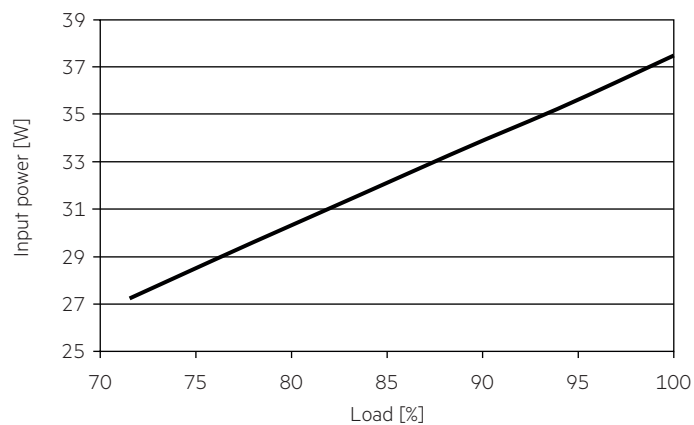

4.2 Maximum loading of automatic circuit breakers in relation to inrush current

Automatic circuit breaker type	C10	C13	C16	C20	B10	B13	B16	B20	Inrush current	
Installation Ø	1.5 mm ²	1.5 mm ²	2.5 mm ²	2.5 mm ²	1.5 mm ²	1.5 mm ²	2.5 mm ²	2.5 mm ²	I _{max}	Time
LC 34/800/42 fixC SRL ADV2	44	53	59	85	28	36	44	54	22 A	120 µs

These are max. values calculated out of inrush current! Please consider not to exceed the maximum rated continuous current of the circuit breaker. Calculation uses typical values from ABB series S200 as a reference. Actual values may differ due to used circuit breaker types and installation environment.

4.3 Harmonic distortion in the mains supply (at 230 V / 50 Hz and full load) in %

	THD	3.	5.	7.	9.	11.
LC 34/800/42 fixC SRL ADV2	< 10	< 15	< 10	< 5	< 5	< 3

Acc. to 6100-3-2. Harmonics < 5 mA or < 0.6 % (whatever is greater) of the input current are not considered for calculation of THD.

5. Functions

5.1 Short-circuit behaviour

In case of a short circuit on the secondary side (LED) the LED driver switches off. After elimination of the short-circuit fault the LED driver will recover automatically.

5.2 No-load operation

The LED driver works in burst working mode to provide a constant output voltage regulation which allows the application to be able to work safely when LED string opens due to a failure.

5.3 Overload protection

If the maximum load is exceeded by a defined internal limit, the LED driver will protect itself and the output current will decrease till LED flicker. After elimination of the overload, the nominal operation is restored automatically.

6. Miscellaneous

6.1 Insulation and electric strength testing of luminaires

Electronic devices can be damaged by high voltage. This has to be considered during the routine testing of the luminaires in production.

According to IEC 60598-1 Annex Q (informative only!) or ENEC 303-Annex A, each luminaire should be submitted to an insulation test with 500 V_{DC} for 1 second. This test voltage should be connected between the interconnected phase and neutral terminals and the earth terminal. The insulation resistance must be at least 2 MΩ.

As an alternative, IEC 60598-1 Annex Q describes a test of the electrical strength with 1500 V_{AC} (or 1.414 x 1500 V_{DC}). To avoid damage to the electronic devices this test must not be conducted.

6.2 Conditions of use and storage

Humidity: 5 % up to max. 85 %, not condensed (max. 56 days/year at 85 %)

Storage temperature: -40 °C up to max. +80 °C

The devices have to be within the specified temperature range (t_a) before they can be operated.

6.3 Maximum number of switching cycles

All LED driver are tested with 50,000 switching cycles.

6.4 Additional information

Additional technical information at www.tridonic.com → Technical Data

Lifetime declarations are informative and represent no warranty claim. No warranty if device was opened.

X-ON Electronics

Largest Supplier of Electrical and Electronic Components

Click to view similar products for [LED Power Supplies](#) category:

Click to view products by [Tridonic](#) manufacturer:

Other Similar products are found below :

[PIFC-K250F](#) [PITB-K222A](#) [AC-A60VD24H2.5](#) [ALD-514012PJ134](#) [PWD-60-1-70-P](#) [ESS030W-1050-21](#) [BPOXL 4-12-035](#) [ESS010W-0180-42](#) [ESS010W-0350-24](#) [ESS010W-0200-42](#) [ESM060W-1400-42](#) [ESS010W-0500-12](#) [SLM140W-1.05-130-ZA](#) [ESS015W-0700-18](#) [HVG-240-54AB](#) [OTE 25/220-240/700 PC](#) [OT FIT 30/220-240/700 CS](#) [DAL30W-0600-42-T](#) [HVG-320-48AB](#) [CNB30W-0600-42-CAS](#) [87500757](#) [I-SELECT 2 PLUG 2100MA BL](#) [LCU 48V 75W DC-STR FO](#) [LC 45 W 500-1400 MA FLEXC SC EXC](#) [I-SELECT 2 PLUG 2000MA BL](#) [LC 50/200-350/170 FLEXCC LP SNC3](#) [LCO 14/100-500/38 O4A NF C EXC3](#) [LC 28W 300-700MA 42 FLEXC NF SC EXC3](#) [LC 44/1050/42 FIXC SRL ADV2](#) [LCA 60W 900-1750MA ONE4ALL C PRE](#) [LC 8/180/44 FIXC SR SNC2](#) [LC 19/200-350/54 FLEXC LP SNC4](#) [BXDR-PS-75BS-E116D-01-A](#) [LC 30/500/54 FIXC SR SNC2](#) [LCA 60W 24V ONE4ALL SC PRE SP](#) [LC 60W 75-330MA 310V FLEXC NF H16 EXC4](#) [LC 8/180/42 FIXC PC SR SNC2](#) [LC 10/350/29 FIXC SR SNC2](#) [LC 25/500/43 FIXC SR SNC2](#) [LC 50/100-400/140 PO4A NF H16 PRE3](#) [LC 25/600/42 FIXC SRL ADV2](#) [LCO 24/200-1050/39 NF C ADV3](#) [ELEMENT 35/220...240/900 G3](#) [LC 25W 350-1050MA FLEXC SR EXC](#) [LC 35W 24 ONE4ALL IP PRE](#) [BXDR-PS-25BS-E107D-01-A](#) [LC 17W 250-700MA FLEXC SR EXC](#) [LC 15W 350MA FIXC C SNC](#) [LC 14W 700MA FIXC PC SR SNC2](#) [LC 200W 24V SC SNC](#)