

Driver LC 35W 350/500/800/1050mA fixC C SNC

essence series

Product description

- Fixed output built-in LED driver
- Constant current LED driver
- Output current 350, 500, 800 or 1,050 mA
- Max. output power 35 W
- Nominal life-time up to 50,000 h
- For luminaires of protection class I and protection class II
- Temperature protection as per EN 61347-2-13 C5e
- 5-year guarantee (conditions at www.tridonic.com)

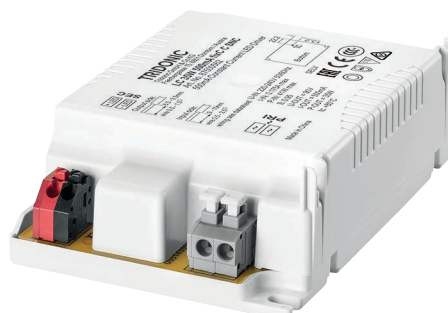

Housing properties

- Casing: polycarbonat, white
- Type of protection IP20

Functions

- Overtemperature protection
- Overload protection
- Short-circuit protection
- No-load protection



Standards, page 2

Wiring diagrams and installation examples, page 3



IP20 SELV 

Driver LC 35W 350/500/800/1050mA fixC C SNC essence series

Technical data

Rated supply voltage	220 – 240 V
AC voltage range	198 – 264 V
Input current (at 230 V, 50 Hz, full load)	0.175 A
Mains frequency	50 / 60 Hz
Typ. power consumption (at 230 V, 50 Hz, full load)	38.5 W
Max. input power	41 W
Output power range	24 – 35 W
THD (at 230 V, 50 Hz, full load)	< 20 %
Output current tolerance [®]	± 7.5 %
Typ. current ripple (at 230 V, 50 Hz, full load)	± 30 %
Starting time (at 230 V, 50 Hz, full load)	≤ 0.5 s
Turn off time (at 230 V, 50 Hz, full load)	≤ 0.5 s
Hold on time at power failure (output)	0 s
Ambient temperature ta	-20 ... +50 °C
Ambient temperature ta (at life-time 50,000 h)	40 °C
Max. casing temperature tc	80 °C
Storage temperature ts	-40 ... +80 °C
Life-time	up to 50,000 h
Guarantee (conditions at www.tridonic.com)	5 years
Dimensions L x W x H	103 x 67 x 29.7 mm

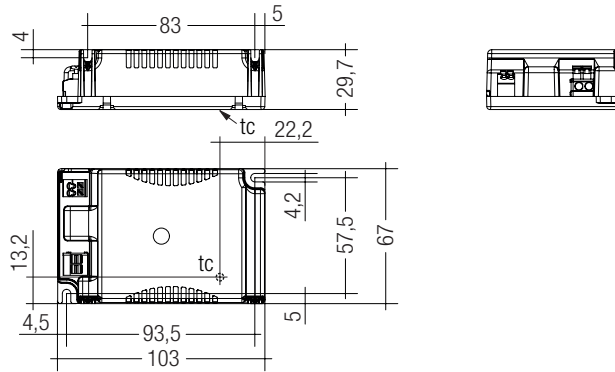

Ordering data

Type [®]	Article number	Packaging, carton	Packaging, low volume	Packaging, high volume	Weight per pc.
LC 35W 350mA fixC C SNC	87500561	15 pc(s).	345 pc(s).	2,760 pc(s).	0.125 kg
LC 35W 500mA fixC C SNC	87500562	15 pc(s).	345 pc(s).	2,760 pc(s).	0.124 kg
LC 35W 800mA fixC C SNC	87500576	15 pc(s).	345 pc(s).	2,760 pc(s).	0.124 kg
LC 35W 1050mA fixCC SNC	87500563	15 pc(s).	345 pc(s).	2,760 pc(s).	0.125 kg

Specific technical data

Type	Output current [®]	λ at full load [®]	Efficiency at full load [®]	λ at min. load [®]	Efficiency at min. load [®]	Min. forward voltage	Max. forward voltage	Max. output voltage	Max. output peak current at full load [®]	Max. output peak current at min. load [®]
LC 35W 350mA fixC C SNC	350 mA	0.95	91 %	0.90C	89 %	70 V	100 V	120 V	480 mA	530 mA
LC 35W 500mA fixC C SNC	500 mA	0.95	90 %	0.90C	88 %	49 V	70 V	90 V	700 mA	760 mA
LC 35W 800mA fixC C SNC	800 mA	0.95	91 %	0.91C	90 %	30 V	43 V	54 V	1,120 mA	1,280 mA
LC 35W 1050mA fixC C SNC	1,050 mA	0.95	89 %	0.90C	87 %	23 V	33 V	50 V	1,470 mA	1,580 mA

[®] Test result at 230 V, 50 Hz.

[®] The trend between min. and full load is linear.

[®] Output current is mean value.

[®] The crossed out articles are phased out.

Standards

EN 55015
EN 61000-3-2
EN 61000-3-3
EN 61347-1
EN 61347-2-13
EN 61547

Overload protection

If the maximum load is exceeded by a defined internal limit, the LED driver will protect itself and LED may flicker. After elimination of the overload, the nominal operation is restored automatically.

Overtemperature protection

The LED driver is protected against temporary thermal overheating. If the temperature limit is exceeded, the output current is reduced to limit t_c at a certain level. The temperature protection is activated typically at 10 °C above t_c max.

Short-circuit behaviour

In case of a short circuit on the secondary side (LED) the LED driver switches into hic-cup mode. After elimination of the short-circuit fault the LED driver will recover automatically.

No-load operation

The LED driver works in burst working mode to provide a constant output voltage regulation which allows the application to be able to work safely when LED string opens due to a failure.

Expected life-time

Type	t_a	40 °C	50 °C	60 °C
LC 35W xxxmA fixC C SNC	t_c	70 °C	80 °C	x
	Life-time	50,000h	30,000h	x

The LED drivers are designed for a life-time stated above under reference conditions and with a failure probability of less than 10 %. Life-time declarations are informative and represent no warranty claim.

The relation of t_c to t_a temperature depends also on the luminaire design. If the measured t_c temperature is approx. 5 K below t_c max., t_a temperature should be checked and eventually critical components (e.g. ELCAP) measured. Detailed information on request.

Maximum loading of automatic circuit breakers in relation to inrush current

Automatic circuit breaker type	C10	C13	C16	C20	B10	B13	B16	B20	Inrush current	
Installation Ø	1.5 mm ²	1.5 mm ²	1.5 mm ²	2.5 mm ²	1.5 mm ²	1.5 mm ²	1.5 mm ²	2.5 mm ²	I_{max}	Time
LC 35W 350mA fixC C SNC	45	60	75	95	45	60	75	95	10 A	100 µs
LC 35W 500mA fixC C SNC	45	60	75	95	45	60	75	95	10 A	100 µs
LC 35W 800mA fixC C SNC	45	65	75	95	45	65	75	95	10 A	100 µs
LC 35W 1050mA fixC C SNC	45	60	75	95	45	60	75	95	10 A	100 µs

These are max. values calculated out of continuous current running the device on full load. There is no limitation due to inrush current. If load is smaller than full load for calculation only continuous current has to be considered.

Harmonic distortion in the mains supply (at 230 V / 50 Hz and full load) in %

	THD	3.	5.	7.	9.	11.
LC 35W 350mA fixC C SNC	20	11	3	2	2	2
LC 35W 500mA fixC C SNC	20	9	3	3	2	2
LC 35W 800mA fixC C SNC	20	11	2	2	2	2
LC 35W 1050mA fixC C SNC	20	14	4	2	2	2

Glow-wire test

according to EN 61347-1 with increased temperature of 850 °C passed.

Mounting of device

Max. torque for fixing: 0.5 Nm/M4

Conditions of use and storage

Humidity: 5 % up to max. 85 %, not condensed (max. 56 days/year at 85 %)

Storage temperature: -40 °C up to max. +80 °C

The devices have to be within the specified temperature range (t_a) before they can be operated.

Installation instructions

The LED module and all contact points within the wiring must be sufficiently insulated against 3 kV surge voltage. Air and creepage distance must be maintained.

Replace LED module

1. Mains off
2. Remove LED module
3. Wait for 10 seconds
4. Connect LED module again

Hot plug-in or secondary switching of LEDs is not permitted and may cause a very high current to the LEDs.

Wiring diagram

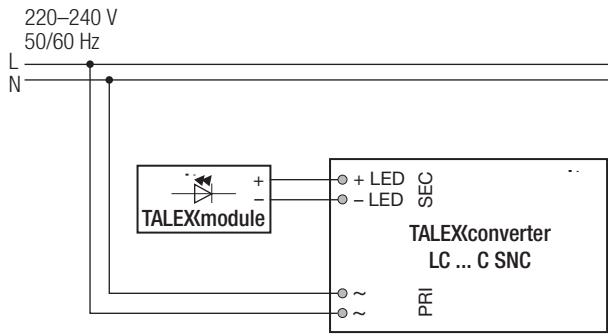

Insulation and electric strength testing of luminaires

Electronic devices can be damaged by high voltage. This has to be considered during the routine testing of the luminaires in production.

According to IEC 60598-1 Annex Q (informative only!) or ENEC 303-Annex A, each luminaire should be submitted to an insulation test with 500 V_{DC} for 1 second. This test voltage should be connected between the interconnected phase and neutral terminals and the earth terminal. The insulation resistance must be at least 2 MΩ.

As an alternative, IEC 60598-1 Annex Q describes a test of the electrical strength with 1500 V_{AC} (or 1.414 x 1500 V_{DC}). To avoid damage to the electronic devices this test must not be conducted.

Conditions of use

The LED driver is declared as inbuilt LED controlgear, meaning it is intended to be used within a luminaire enclosure. If the product is used outside a luminaire, the installation must provide suitable protection for people and environment (e.g. in illuminated ceilings).

Maximum number of switching cycles

All LED driver are tested with 50,000 switching cycles.

Additional information

Additional technical information at www.tridonic.com → Technical Data

Life-time declarations are informative and represent no warranty claim. No warranty if device was opened.

Wiring type and cross section

The input wiring can be stranded wires with ferrules with a cross section of 0.5 – 1.5 mm² or with solid wires with a cross section of 0.5 – 2.5 mm². Strip 9 – 10 mm of insulation from the cables to ensure perfect operation of the push-wire terminals.

The output wiring can be done with a cross section of 0.5 – 1.5 mm². Strip 8.5 – 9.5 mm of insulation from the cables to ensure perfect operation of the push-wire terminals.

Input wiring

wire preparation:
Solid: 0.5 – 2.5 mm²
Fine-stranded: 0.5 – 1.5 mm²

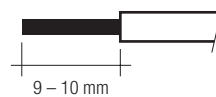

Output wiring

wire preparation:
0.5 – 1.5 mm²

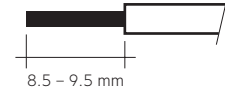

Wiring guidelines

- All connections must be kept as short as possible to ensure good EMI behaviour.
- Mains leads should be kept apart from LED driver and other leads (ideally 5 – 10 cm distance)
- Max. length of output wires is 2 m.
- Secondary switching is not permitted.
- Incorrect wiring can damage LED modules.
- To avoid the damage of the Driver, the wiring must be protected against short circuits to earth (sharp edged metal parts, metal cable clips, louver, etc.).

Release of the wiring

Press down the "push button" and remove the cable from front.

Input terminal

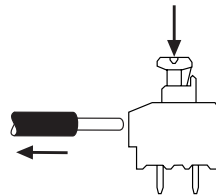

Output terminal

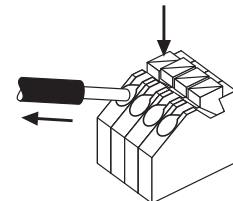

Diagrams LC 35W 350mA fixC C SNC

Efficiency vs load

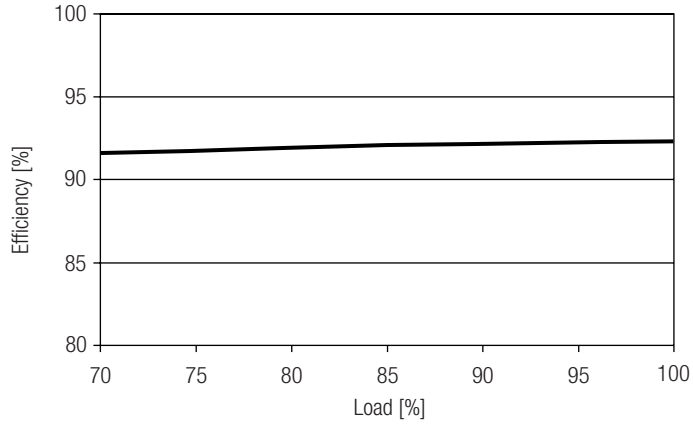

Power factor vs load

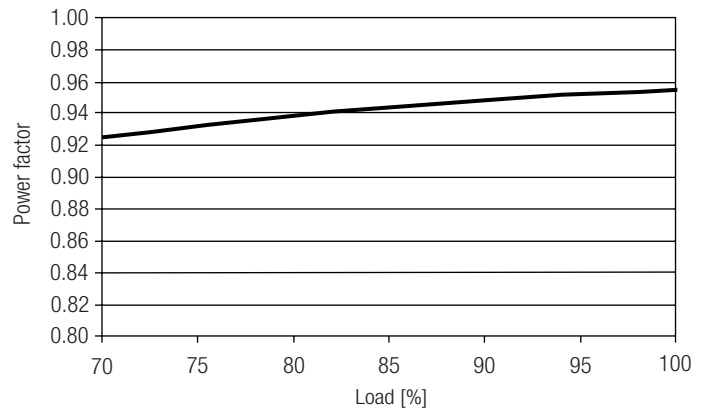

Input power vs load

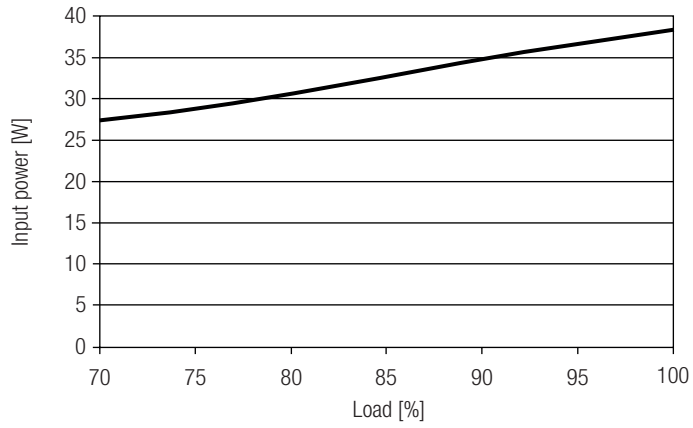

Input current vs load

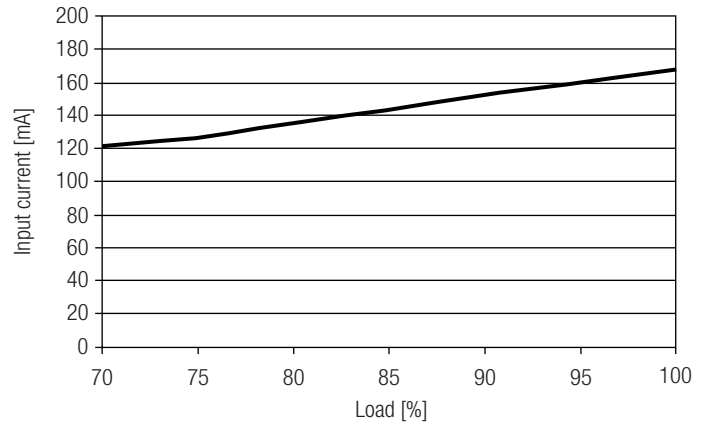

THD vs load

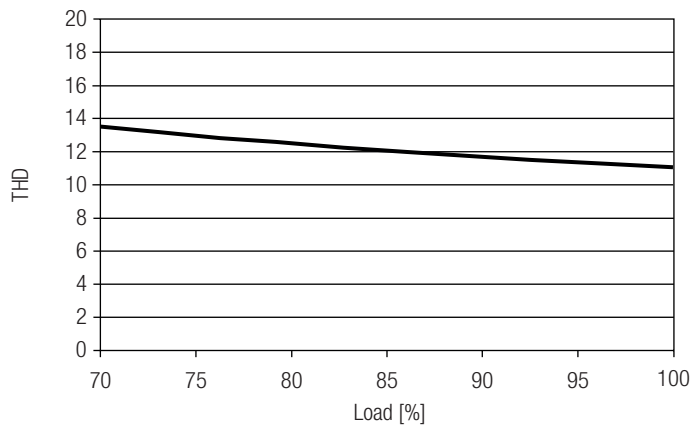

Diagrams LC 35W 500mA fixC C SNC

Efficiency vs load

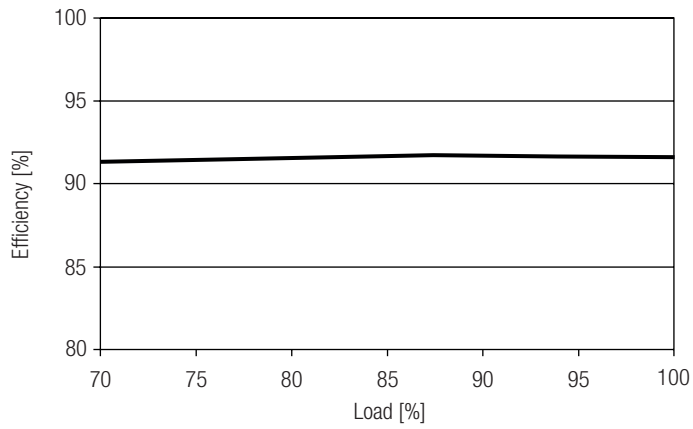

Power factor vs load

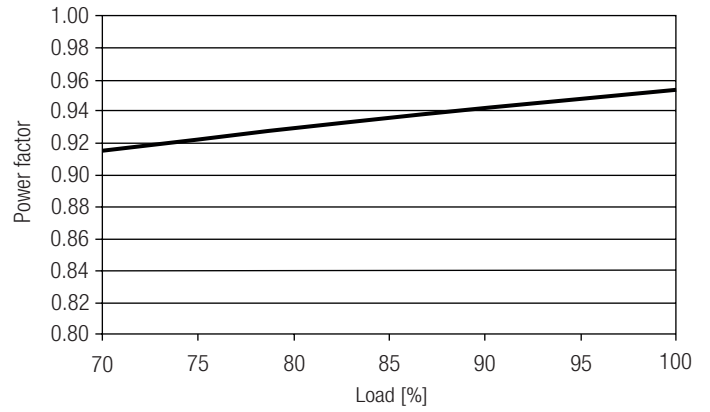

Input power vs load

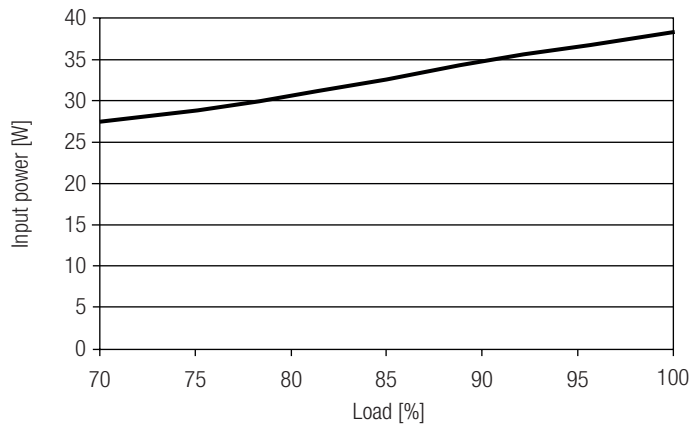

Input current vs load

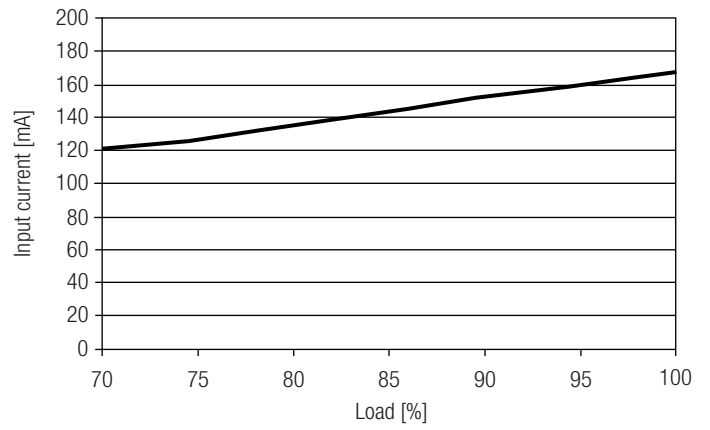

THD vs load

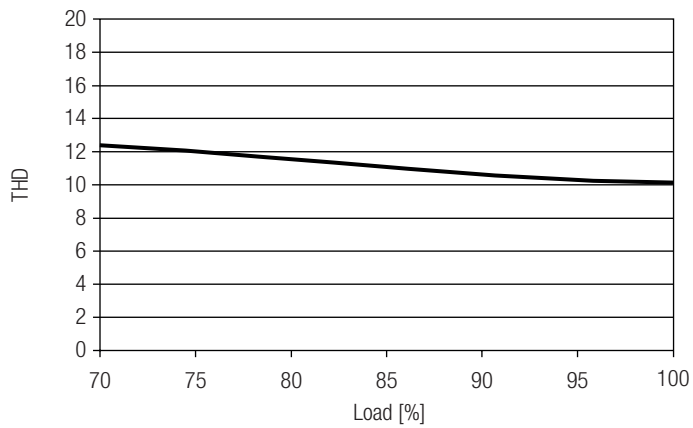

Diagrams LC 35W 800mA fixC C SNC

Efficiency vs load

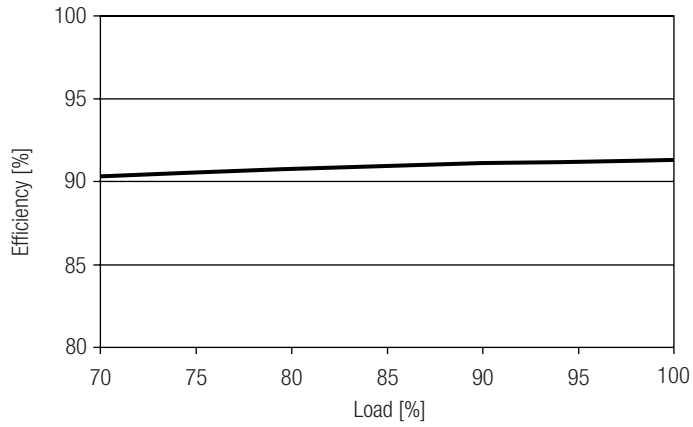

Power factor vs load

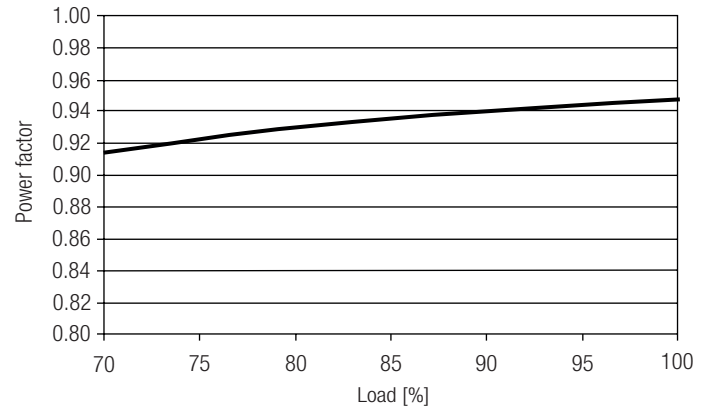

Input power vs load

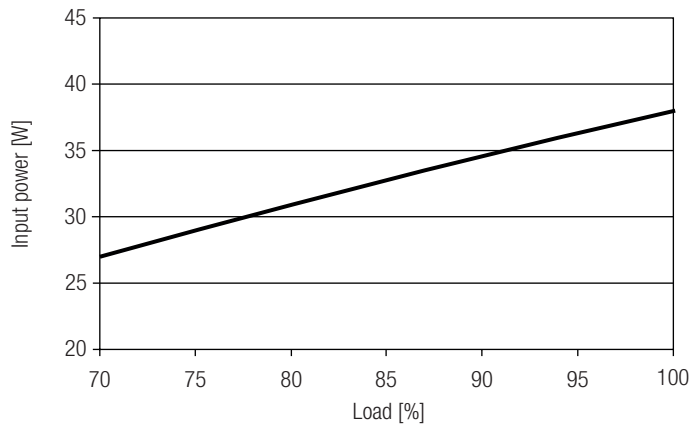

Input current vs load

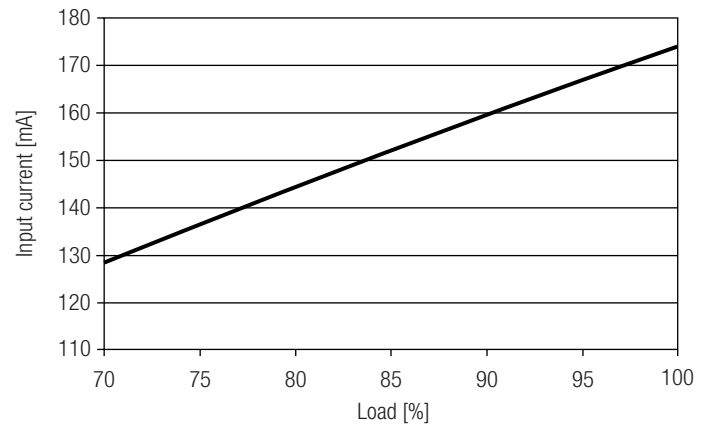

THD vs load

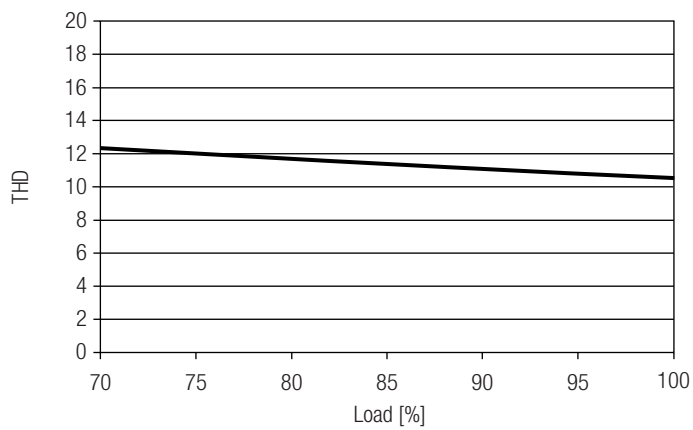

Diagrams LC 35W 1050mA fix C SNC

Efficiency vs load

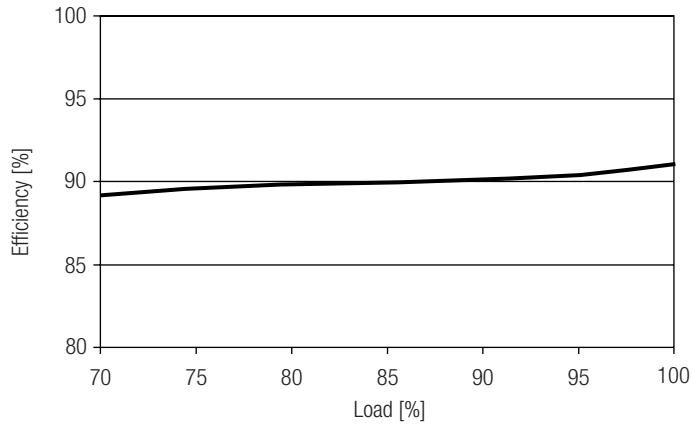

Power factor vs load

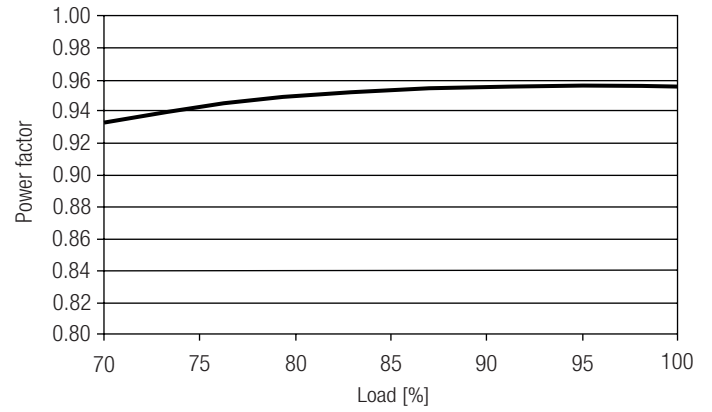

Input power vs load

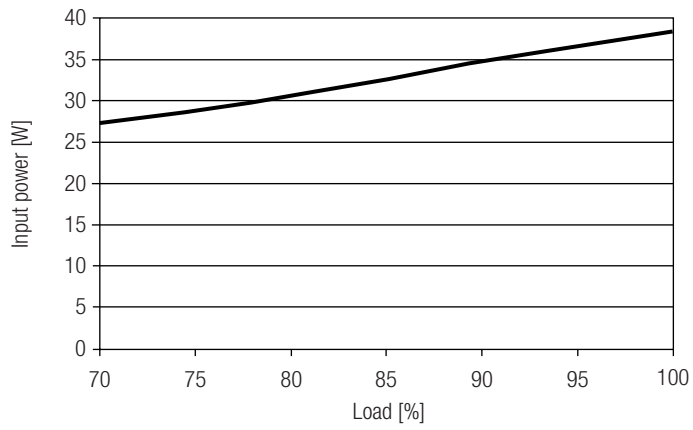

Input current vs load

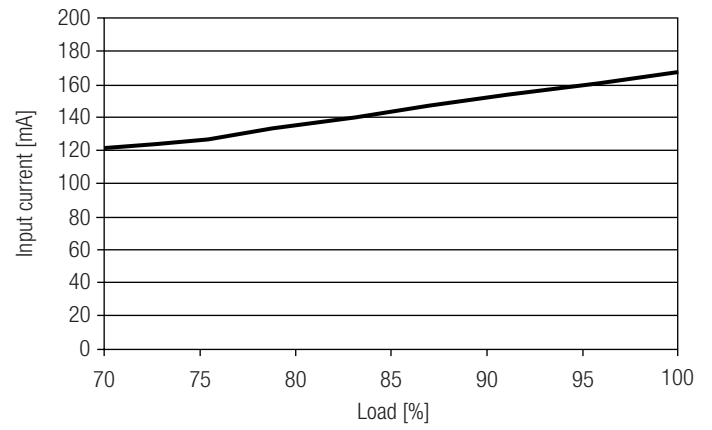

THD vs load

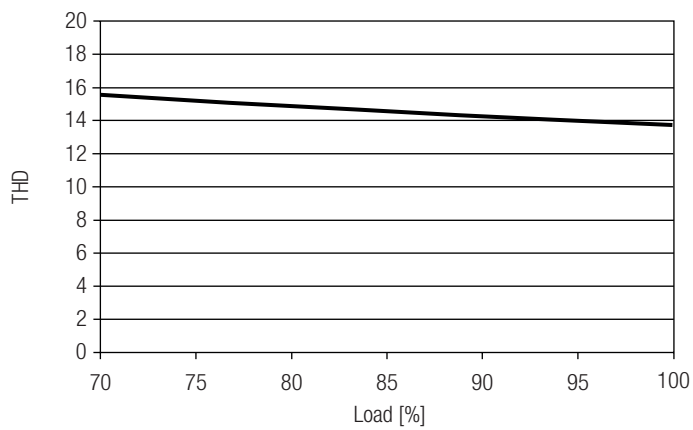

X-ON Electronics

Largest Supplier of Electrical and Electronic Components

Click to view similar products for [LED Power Supplies](#) category:

Click to view products by [Tridonic](#) manufacturer:

Other Similar products are found below :

[PIFC-K250F](#) [PITB-K222A](#) [AC-A60VD24H2.5](#) [ALD-514012PJ134](#) [PWD-60-1-70-P](#) [EUG-200S210DT](#) [ESS030W-1050-21](#) [BPOXL 4-12-035](#) [ESS010W-0180-42](#) [ESS010W-0350-24](#) [ESS010W-0200-42](#) [SLM140W-1.05-130-ZA](#) [ESS015W-0700-18](#) [HVG-240-48AB](#) [HVG-240-54AB](#) [OTE 25/220-240/700 PC](#) [DAL30W-0600-42-T](#) [HVG-320-48AB](#) [CNB30W-0600-42-CAS](#) [87500757](#) [I-SELECT 2 PLUG 2100MA BL](#) [LCU 48V 75W DC-STR FO](#) [LC 45 W 500-1400 MA FLEXC SC EXC](#) [I-SELECT 2 PLUG 2000MA BL](#) [LC 50/200-350/170 FLEXCC LP](#) [SNC3](#) [LCO 14/100-500/38 O4A NF C EXC3](#) [LC 28W 300-700MA 42 FLEXC NF SC EXC3](#) [LC 44/1050/42 FIXC SRL ADV2](#) [LCA 60W 900-1750MA ONE4ALL C PRE](#) [LC 8/180/44 FIXC SR SNC2](#) [LC 19/200-350/54 FLEXC LP SNC4](#) [BXDR-PS-75BS-E116D-01-A](#) [LC 30/500/54 FIXC SR SNC2](#) [LCA 60W 24V ONE4ALL SC PRE SP](#) [LC 60W 75-330MA 310V FLEXC NF H16 EXC4](#) [LC 8/180/42 FIXC PC SR SNC2](#) [LC 10/350/29 FIXC SR SNC2](#) [LC 25/500/43 FIXC SR SNC2](#) [LC 50/100-400/140 PO4A NF H16 PRE3](#) [LC 25/600/42 FIXC SRL ADV2](#) [LCO 24/200-1050/39 NF C ADV3](#) [ELEMENT 35/220...240/900 G3](#) [LC 25W 350-1050MA FLEXC SR EXC](#) [LC 60/700/86 FIXC SR SNC2](#) [LC 35W 24 ONE4ALL IP PRE](#) [BXDR-PS-25BS-E107D-01-A](#) [LC 17W 250-700MA FLEXC SR EXC](#) [LC 15W 350MA FIXC C SNC](#) [LC 14W 700MA FIXC PC SR SNC2](#) [LC 200W 24V SC SNC](#)