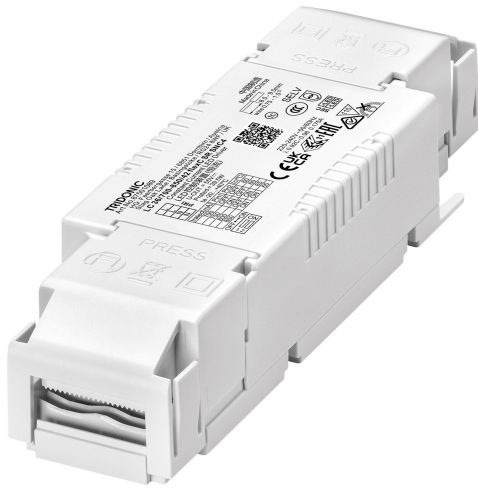

**Driver LC 36W 700-850mA flexC SR SNC4**

essence series

**Product description**

- \_ Independent fixed output LED driver
- \_ For luminaires of protection class II
- \_ For luminaires with M and MM as per EN 60598, VDE 0710 and VDE 0711
- \_ Temperature protection as per EN 61347-2-13 C5e
- \_ Selectable fixed output current via DIP switch 700, 750, 800 and 850 mA (pre-selected current 700 mA)
- \_ Max. output power 35.7 W
- \_ Up to 90.5 % efficiency
- \_ Nominal lifetime up to 100,000 h
- \_ 5 years guarantee (conditions at [www.tridonic.com](http://www.tridonic.com))

**Housing properties**

- \_ Casing: polycarbonate, white
- \_ Type of protection IP20

**Interfaces**

- \_ Terminal blocks: 45° push terminals

**Functions**

- \_ Overload protection
- \_ Short-circuit protection
- \_ No-load protection
- \_ Overtemperature protection
- \_ Burst protection voltage 1 kV
- \_ Burst protection voltage 1 kV (L to N)
- \_ Surge protection voltage 2 kV (L/N to earth)

**Typical applications**

- \_ For spot light and downlight in retail and hospitality applications
- \_ For panel light and area light in office and education application

**Website**

<http://www.tridonic.com/87501089>



Spotlights



Downlights



Linear



Area



Floor | Wall



Free-standing



Street



Decorative



High bay

## Driver LC 36W 700-850mA flexC SR SNC4

essence series

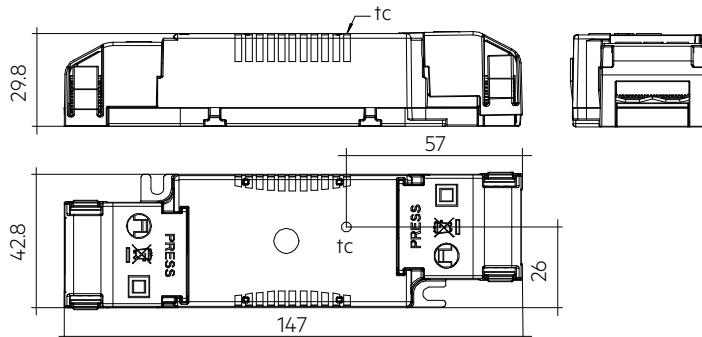

## Ordering data

Type	Article number	Packaging, carton	Packaging, pallet	Packaging, high volume	Weight per pc.
LC 36/700-850/42 flexC SR SNC4	87501089	10 pc(s).	80 pc(s).	1,200 pc(s).	0.097 kg

## Technical data

Rated supply voltage	220 – 240 V
AC voltage range	198 – 264 V
Max. input current (at 230 V, 50 Hz, full load)	0.175 A
Mains frequency	50 / 60 Hz
Overvoltage protection	320 V AC, 2 h
Typ. power consumption (at 230 V, 50 Hz, full load) <sup>①</sup>	39.5 W
Min. output power	16.8 W
Max. output power	35.7 W
Typ. efficiency (at 230 V, 50 Hz, full load) <sup>①</sup>	90.5 %
$\lambda$ over full operating range (max.) <sup>①</sup>	0.98
$\lambda$ over full operating range (min.)	0.92C
Output current tolerance <sup>②③</sup>	$\pm 7.5$ %
Max. output current peak <sup>④</sup>	$\leq$ output current + 12 %
Max. output voltage (U-OUT)	55 V
THD (at 230 V, 50 Hz, full load)	$< 15$ %
Output LF current ripple ( $< 120$ Hz)	$\pm 5$ %
Output P_ST_LM (at full load)	$\leq 1$
Output SVM (at full load)	$\leq 0.4$
Starting time (at 230 V, 50 Hz, full load)	$\leq 0.5$ s
Turn off time (at 230 V, 50 Hz, full load)	$\leq 0.5$ s
Hold on time at power failure (output)	0 s
Ambient temperature $t_a$ (at lifetime 50,000 h)	40 °C
Storage temperature $t_s$	-40 ... +80 °C
Mains burst capability	1 kV
Mains surge capability (between L - N)	1 kV
Mains surge capability (between L/N - PE)	2 kV
Surge voltage at output side (against PE)	3 kV
Lifetime	up to 100,000 h
Guarantee (conditions at <a href="http://www.tridonic.com">www.tridonic.com</a> )	5 Year(s)
Dimensions L x W x H	147 x 43 x 30 mm

## Approval marks



## Standards

EN 55015, EN 60598-1, EN 61000-3-2, EN 61000-3-3, EN 61347-1, EN 61347-2-13, EN 61547, EN 62384

## Specific technical data

Type	Output current <sup>①</sup>	Min. output voltage	Max. output voltage	Max. output power	Typ. power consumption (at 230 V, 50 Hz, full load)	Typ. current consumption (at 230 V, 50 Hz, full load)	Efficiency (at 230 V, 50 Hz, full load)	tc point max.	Ambient temperature ta	I-out select
<b>LC 36/700-850/42 flexC SR SNC4</b>	700 mA	24 V	42 V	29.4 W	32.9 W	145 mA	89.5 %	60 °C	-20 ... +40 °C	1=off / 2=off
<b>LC 36/700-850/42 flexC SR SNC4</b>	750 mA	24 V	42 V	31.5 W	35.3 W	155 mA	90.0 %	60 °C	-20 ... +40 °C	1=on / 2=off
<b>LC 36/700-850/42 flexC SR SNC4</b>	800 mA	24 V	42 V	33.6 W	37.6 W	165 mA	90.0 %	65 °C	-20 ... +40 °C	1=off / 2=on
<b>LC 36/700-850/42 flexC SR SNC4</b>	850 mA	24 V	42 V	35.7 W	39.5 W	175 mA	90.5 %	65 °C	-20 ... +40 °C	1=on / 2=on

① Test result at 850 mA.

② Output current is mean value.

③ Test result at default output current.

④ Test result at 25 °C.

1. Standards

- EN 55015
- EN 60598-1
- EN 61000-3-2
- EN 61000-3-3
- EN 61347-1
- EN 61347-2-13
- EN 61547
- EN 62384

1.1 Glow wire test

according to EN 61347-1 with increased temperature of 850 °C passed.

2. Thermal details and lifetime

2.1 Expected lifetime

Expected lifetime					
Type	Current	ta	25 °C	30 °C	40 °C
LC 36/700-850/42 flexC SR SNC4	700 mA	tc	45 °C	50 °C	60 °C
		Lifetime	100,000 h	100,000 h	90,000 h
	750 mA	tc	45 °C	50 °C	60 °C
		Lifetime	100,000 h	100,000 h	90,000 h
800 mA	tc	50 °C	55 °C	65 °C	
	Lifetime	100,000 h	100,000 h	65,000 h	
850 mA	tc	50 °C	55 °C	65 °C	
	Lifetime	100,000 h	100,000 h	65,000 h	

The LED driver is designed for a lifetime stated above under reference conditions and with a failure probability of less than 10 %.

The relation of tc to ta temperature depends also on the luminaire design. If the measured tc temperature is approx. 5 K below tc max., ta temperature should be checked and eventually critical components (e.g. ELCAP) measured. Detailed information on request.

3. Installation / wiring

3.1 Circuit diagram

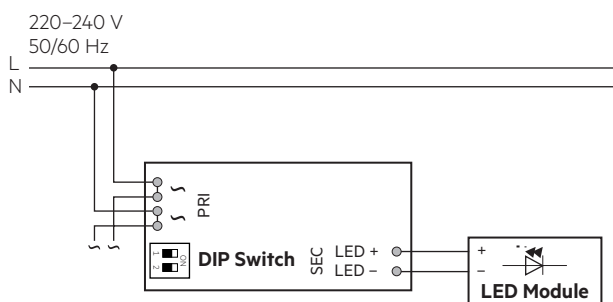

Device with loop through wiring function.

3.2 Wiring type and cross section

For wiring use stranded wire with ferrules or solid wire from 0.75–1.5 mm<sup>2</sup> (mains wires) and 0.2–1.5 mm<sup>2</sup> (secondary wires, LED module). Strip 8.5–9.5 mm of insulation from the cables to ensure perfect operation of the push-wire terminals. Use one wire for each terminal connector only.

Input terminal (D2):

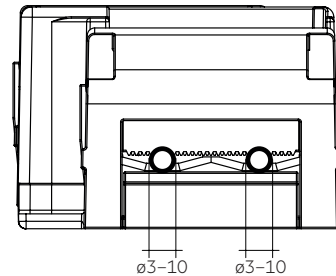
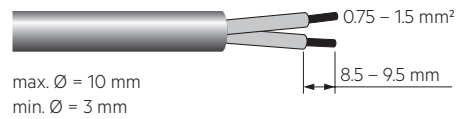

Output terminal (D1):

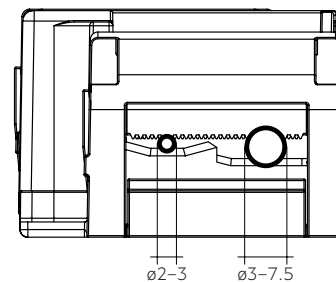
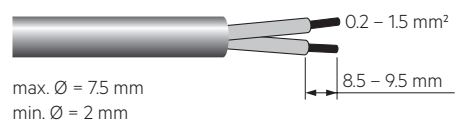

3.3 Loose wiring

Press down the “push button” and remove the cable from front.

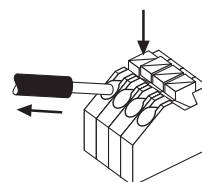

3.4 Fixing conditions

Dry, acidfree, oilfree, fatfree. It is not allowed to exceed the maximum ambient temperature (ta) stated on the device. Minimum distances stated below are recommendations and depend on the actual luminaire. Is not suitable for fixing in corner.

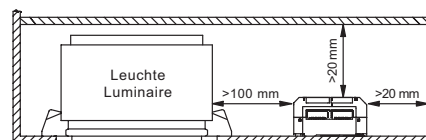

The LED module and all contact points within the wiring must be sufficiently insulated against 3 kV surge voltage.

**3.5 Wiring guidelines**

- All connections must be kept as short as possible to ensure good EMI behaviour.
- Mains leads should be kept apart from LED driver and other leads (ideally 5 – 10 cm distance)
- Max. length of output wires is 2 m.
- To comply with the EMC regulations run the secondary wires (LED module) in parallel.
- Incorrect wiring can damage LED modules.
- To avoid the damage of the Driver, the wiring must be protected against short circuits to earth (Sharp edged metal parts, metal cable clips, louver, etc.).
- The current selection has to be installed in the accordance to the requirement of low voltage installation.
- Through wiring of mains is for connecting additional LED driver only. Max. permanent current of 2 A may not be exceeded.

**3.6 Replace LED module**

1. Mains off
2. Remove LED module
3. Wait for 20 seconds
4. Connect LED module again

Hot plug-in or output switching of LEDs is not permitted and may cause a very high current to the LEDs.

**3.7 Current setting**

 Set the current by DIP switch after mains off. Use of DIP switch only after mains off.

**700 mA:** Switch 1 = Off, Switch 2 = Off

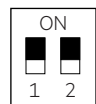

**750 mA:** Switch 1 = On, Switch 2 = Off

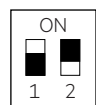

**800 mA:** Switch 1 = Off, Switch 2 = On

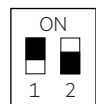

**850 mA:** Switch 1 = On, Switch 2 = On

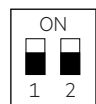

**3.8 Mounting of device**

Max. torque for fixing: 0.5 Nm/M4

**4. Electrical values**

Test at 230 V 50 Hz.

**4.1 Efficiency vs load**

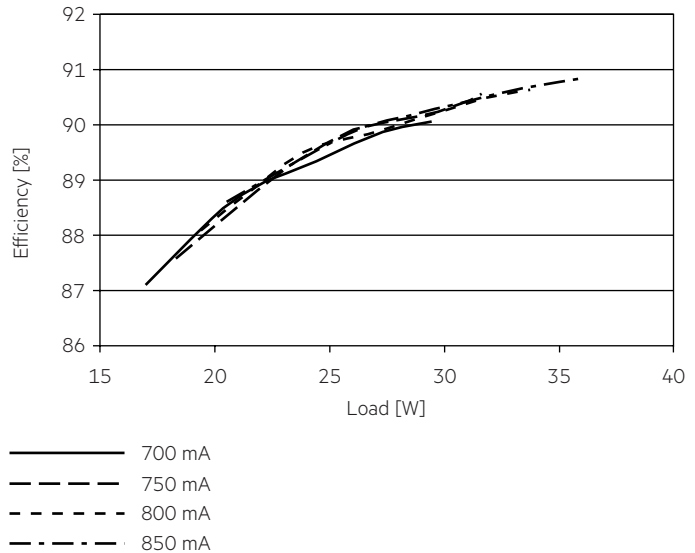

**4.2 Power factor vs load**

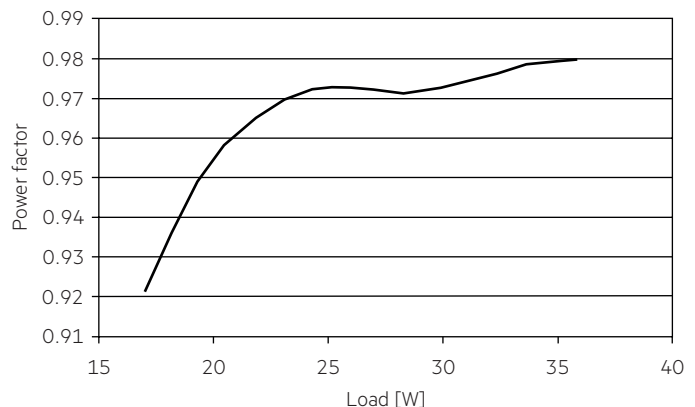

**4.3 THD vs load**

THD without harmonic < 5 mA (0.6 %) of the input current:

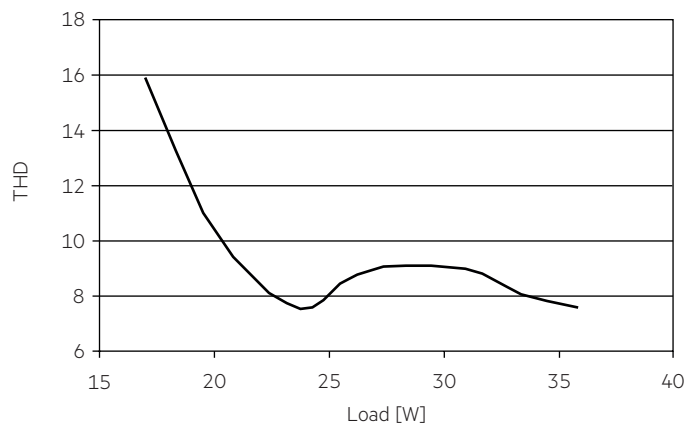

#### 4.6 Maximum loading of automatic circuit breakers in relation to inrush current

Automatic circuit breaker type	C10	C13	C16	C20	B10	B13	B16	B20	Inrush current	
Installation Ø	1.5 mm <sup>2</sup>	1.5 mm <sup>2</sup>	1.5 mm <sup>2</sup>	2.5 mm <sup>2</sup>	1.5 mm <sup>2</sup>	1.5 mm <sup>2</sup>	1.5 mm <sup>2</sup>	2.5 mm <sup>2</sup>	I <sub>max</sub>	Time
<b>LC 36/700-850/42 flexC SR SNC4</b>	23	30	36	46	14	18	22	28	24 A	200 µs

These are max. values calculated out of inrush current! Please consider not to exceed the maximum rated continuous current of the circuit breaker. Calculation uses typical values from ABB series S200 as a reference. Actual values may differ due to used circuit breaker types and installation environment.

#### 4.7 Harmonic distortion in the mains supply (at 230 V / 50 Hz and full load) in %

	THD	3.	5.	7.	9.	11.
<b>LC 36/700-850/42 flexC SR SNC4</b>	< 15	< 10	< 6	< 3	< 3	< 3

## 5. Functions

### 5.1 Short-circuit behaviour

In case of a short circuit on the output side (LED) the LED driver switches off. After elimination of the short-circuit fault the LED driver will recover automatically.

### 5.2 No-load operation

The LED driver works in burst working mode to provide a constant output voltage regulation which allows the application to be able to work safely when LED string opens due to a failure.

### 5.3 Overload protection

If the maximum load is exceeded by a defined internal limit, the LED driver will protect itself and LED may flicker. After elimination of the overload, the nominal operation is restored automatically.

### 5.4 Over temperature protection

The LED driver is protected against temporary thermal overheating. If the temperature limit is exceeded, the output current will reduce or LED may flicker. It will recover automatically.

## 6. Miscellaneous

### 6.1 Disposal of equipment



Return old devices in accordance with the WEEE directive to suitable recycling facilities.

### 6.2 Insulation and electric strength testing of luminaires

Electronic devices can be damaged by high voltage. This has to be considered during the routine testing of the luminaires in production.

According to IEC 60598-1 Annex Q (informative only!) or ENEC 303-Annex A, each luminaire should be submitted to an insulation test with 500 V<sub>DC</sub> for 1 second. This test voltage should be connected between the interconnected phase and neutral terminals and the earth terminal. The insulation resistance must be at least 2 M $\Omega$ .

As an alternative, IEC 60598-1 Annex Q describes a test of the electrical strength with 1500 V<sub>AC</sub> (or 1.414 x 1500 V<sub>DC</sub>). To avoid damage to the electronic devices this test must not be conducted.

### 6.3 Conditions of use and storage

Humidity: 5 % up to max. 85 %,  
not condensed  
(max. 56 days/year at 85 %)

Storage temperature: -40 °C up to max. +80 °C

The devices have to be within the specified temperature range (ta) before they can be operated.

### 6.4 Maximum number of switching cycles

All LED driver are tested with 50,000 switching cycles.

### 6.5 Additional information

Additional technical information at [www.tridonic.com](http://www.tridonic.com) → Technical Data

Lifetime declarations are informative and represent no warranty claim. No warranty if device was opened.

## X-ON Electronics

Largest Supplier of Electrical and Electronic Components

*Click to view similar products for [LED Power Supplies](#) category:*

*Click to view products by [Tridonic](#) manufacturer:*

Other Similar products are found below :

[PIFC-K250F](#) [PITB-K222A](#) [AC-A60VD24H2.5](#) [ALD-514012PJ134](#) [PWD-60-1-70-P](#) [EUG-200S210DT](#) [ESS030W-1050-21](#) [BPOXL 4-12-035](#) [ESS010W-0180-42](#) [ESS010W-0350-24](#) [ESS010W-0200-42](#) [SLM140W-1.05-130-ZA](#) [ESS015W-0700-18](#) [HVG-240-48AB](#) [HVG-240-54AB](#) [OTE 25/220-240/700 PC](#) [DAL30W-0600-42-T](#) [HVG-320-48AB](#) [CNB30W-0600-42-CAS](#) [87500757](#) [I-SELECT 2 PLUG 2100MA BL](#) [LCU 48V 75W DC-STR FO](#) [LC 45 W 500-1400 MA FLEXC SC EXC](#) [I-SELECT 2 PLUG 2000MA BL](#) [LC 50/200-350/170 FLEXCC LP](#) [SNC3](#) [LCO 14/100-500/38 O4A NF C EXC3](#) [LC 28W 300-700MA 42 FLEXC NF SC EXC3](#) [LC 44/1050/42 FIXC SRL ADV2](#) [LCA 60W 900-1750MA ONE4ALL C PRE](#) [LC 8/180/44 FIXC SR SNC2](#) [LC 19/200-350/54 FLEXC LP SNC4](#) [BXDR-PS-75BS-E116D-01-A](#) [LC 30/500/54 FIXC SR SNC2](#) [LCA 60W 24V ONE4ALL SC PRE SP](#) [LC 60W 75-330MA 310V FLEXC NF H16 EXC4](#) [LC 8/180/42 FIXC PC SR SNC2](#) [LC 10/350/29 FIXC SR SNC2](#) [LC 25/500/43 FIXC SR SNC2](#) [LC 50/100-400/140 PO4A NF H16 PRE3](#) [LC 25/600/42 FIXC SRL ADV2](#) [LCO 24/200-1050/39 NF C ADV3](#) [ELEMENT 35/220...240/900 G3](#) [LC 25W 350-1050MA FLEXC SR EXC](#) [LC 60/700/86 FIXC SR SNC2](#) [LC 35W 24 ONE4ALL IP PRE](#) [BXDR-PS-25BS-E107D-01-A](#) [LC 17W 250-700MA FLEXC SR EXC](#) [LC 15W 350MA FIXC C SNC](#) [LC 14W 700MA FIXC PC SR SNC2](#) [LC 200W 24V SC SNC](#)