



Driver LC 38W 650–1050mA 42V one4all NFC SC EXC3
excite series

Product description

- NEW: lumDATA (DALI-2 part ext. 251, 252 and 253)
- Can be either used build-in or independent with clip-on strain-relief (see accessory)
- Dimming range 1 – 100 % (min. 5 mA)
- For luminaires of protection class I and protection class II
- Temperature protection as per EN 61347-2-13 C5e
- Adjustable output current between 650 – 1,050 mA via NFC or DALI
- Max. output power 38 W
- Up to 88 % efficiency
- Lowest power input on stand-by < 0.4 W
- Nominal lifetime up to 100,000 h
- 5 years guarantee (conditions at www.tridonic.com)

Housing properties

- Casing: polycarbonate, white
- Type of protection IP20

Interfaces

- Near field communication (NFC)
- one4all (DALI-2 DT 6, switchDIM, corridorFUNCTION)
- Terminal blocks: 45° push terminals

Functions

- Adjustable output current in 1-mA-steps (NFC, DALI)
- Enhanced constant light output function (eCLO)
- Protective features (overtemperature, short-circuit, overload, no-load)
- Suitable for emergency escape lighting systems acc. to EN 50172

Benefits

- Flexible configuration via companionSUITE (NFC, DALI)
- Application-oriented operating window for max. compatibility
- Best energy savings due to low stand-by losses and high efficiency
- In-field programming possible after installation with NFC interface

Typical applications

- For downlight, spotlight and decorative applications



Standards, page 4

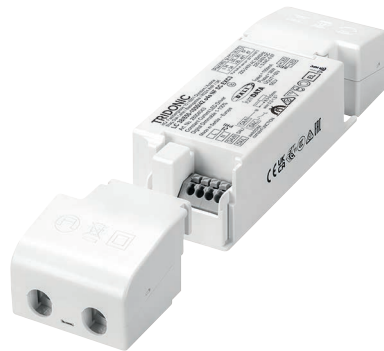

With strain-relief





Driver LC 38W 650–1050mA 42V one4all NFC SC EXC3 excite series

Technical data

Rated supply voltage	220 – 240 V
AC voltage range	198 – 264 V
DC voltage range	176 – 280 V
Mains frequency	0 / 50 / 60 Hz
Overvoltage protection	320 V AC, 48 h
Typ. current (at 230 V, 50 Hz, full load) ^①	196 mA
Typ. current (220 V, 0 Hz, full load, 15 % dimming level) ^②	364 mA
Leakage current (at 230 V, 50 Hz, full load) ^③	< 250 µA
Max. input power	43.67 W
Typ. efficiency (at 230 V / 50 Hz / full load) ^④	88 %
λ (at 230 V, 50 Hz, full load) ^⑤	0.97
λ (over full operating range)	0.55C – 0.97
Typ. power consumption on stand-by ^⑥	< 0.4 W
In-rush current (peak / duration)	5.33 A / 42 µs
THD (at 230 V, 50 Hz, full load) ^⑦	< 10 %
Starting time (AC mode)	< 700 ms
Starting time (DC mode)	< 500 ms
Switchover time (AC/DC) ^⑧	< 800 ms
Turn off time (at 230 V, 50 Hz, full load)	< 50 ms
Output current tolerance ^⑨	± 5 %
Max. peak output current (non-repetitive)	± output current + 20 %
Output LF current ripple (< 120 Hz)	± 5 %
Output P _{STLM} (at full load)	≤ 1
Output SVM (at full load)	≤ 0.4
Max. output voltage	60 V
Dimming range	1 – 100 % (min. 5 mA)
Mains surge capability (between L – N) ^⑩	1 kV
Mains surge capability (between L/N – PE)	2 kV
Burst protection ^⑪	1 kV
Surge voltage at output side (against PE)	< 3 kV
Ambient temperature t _a	-20 ... +50 °C
Max. casing temperature t _c	87 °C
Type of protection	IP20
Lifetime	up to 100,000 h
Guarantee (conditions at www.tridonic.com)	5 years
Dimensions L x W x H	97 x 43 x 30 mm

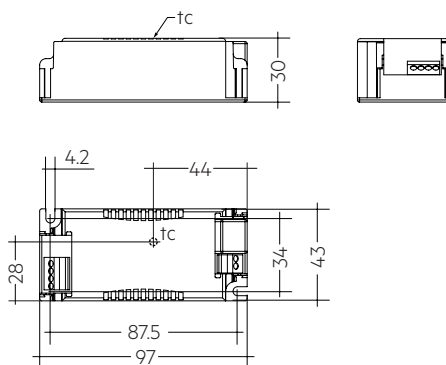

Ordering data

Type	Article number	Packaging carton	Packaging pallet	Weight per pc.
LC 38/650-1050/42 o4a NF SC EXC3	28004043	10 pc(s).	1,150 pc(s).	0.156 kg

Specific technical data

Type	Output current ^①	Min. forward voltage	Max. forward voltage	Max. output power	Typ. power consumption (at 230 V, 50 Hz, full load)	Typ. current consumption (at 230 V, 50 Hz, full load)
LC 38/650-1050/42 o4a NF SC EXC3	650 mA	7.5 V	42.0 V	27.3 W	32.4 W	141 mA
	750 mA	7.5 V	42.0 V	31.5 W	37.0 W	161 mA
	850 mA	7.5 V	42.0 V	35.7 W	42.4 W	184 mA
	950 mA	7.5 V	40.0 V	38.0 W	44.6 W	194 mA
	1,050 mA	7.5 V	36.2 V	38.0 W	43.6 W	196 mA

^① Valid at 100 % dimming level.

^② Depending on the selected output current.

^③ Depending on the DALI traffic at the interface.

^④ Valid for immediate change of power supply type otherwise the starting time is valid.

^⑤ Output current is mean value.

^⑥ L-N acc. to EN 61000-4-5. 2 Ohm, 12/50 µs, 8/20 µs.

^⑦ Also applies to corridorFUNCTION.



Strain-relief set 43x30mm

Product description

- Optional strain-relief set for independent applications
- Transforms the LED driver into a fully class II compatible LED driver (e.g. ceiling installation)
- Easy and tool-free mounting to the LED driver, screwless cable-clamp channels for long strain-relief (30 x 43 x 30 mm)
- With screws for short strain-relief (15 x 34 x 30 mm)
- Overall length = length L (LED driver) + 2 x 30 mm (long strain-relief set), 2 x 15 mm (short strain-relief) or long and short strain-relief any combination
- Standard SC (L = 30 mm) available as non-pre-assembled and pre-assembled
- Short SC (L = 15 mm) only pre-assembled available



ACU SC 30x43x30mm CLIP-ON SR SET ACU SC 30x43x30mm CLIP-ON SR SET 300
(28001168, non-pre-assembled) (28001351, non-pre-assembled, 300 pcs. packaging)



ACU SC 30x43x30mm CLIP-ON SR PA
(28001699, pre-assembled)

ACU SC 15x43x30mm CLIP-ON SR PA
(28001574, pre-assembled)

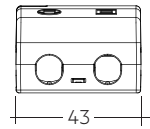
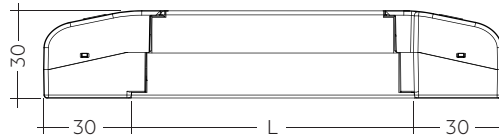

Permissible
cable jacket
diameter:
2.2 – 9 mm

ACU SC 30x43x30mm CLIP-ON SR SET / PA

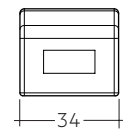
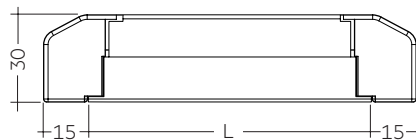

Permissible
cable jacket
diameter:
3 – 9 mm

ACU SC 15x43x30mm CLIP-ON SR PA

Ordering data

Type	Article number	Packaging carton [®]	Packaging outer box	Weight per pc.
ACU SC 43x30mm CLIP-ON SR SET	28001168	10 pc(s).	500 pc(s).	0.038 kg
ACU SC 43x30mm CLIP-ON SR SET 300	28001351	300 pc(s).	300 pc(s).	0.038 kg
ACU SC 30x43x30mm CLIP-ON SR PA	28001699	10 pc(s).	500 pc(s).	0.021 kg
ACU SC 15x43x30mm CLIP-ON SR PA	28001574	10 pc(s).	1,200 pc(s).	0.010 kg

[®] 28001168: A carton of 10 pcs. is equal to 10 sets, each with 2 strain-reliefs parts.

28001351: A carton of 300 pcs. is equal to 300 sets, each with 2 strain-reliefs parts.

28001699 + 28001574: A carton contains exactly 10 pcs. strain-reliefs (no sets).

1. Standards

EN 55015
 EN 61000-3-2
 EN 61000-3-3
 EN 61000-4-4
 EN 61000-4-5
 EN 61347-1
 EN 61347-2-13
 EN 62384
 EN 61547
 EN 62386-101 (DALI-2)
 EN 62386-102 (DALI-2)
 EN 62386-207 (DALI-2)
 According to EN 50172 for use in central battery systems
 According to EN 60598-2-22 suitable for emergency luminaire

1.1 Glow wire test

according to EN 61347-1 with increased temperature of 850 °C passed.

2. Thermal details and lifetime

2.1 Expected lifetime

Expected lifetime for build-in use

Type	Output current	ta	40 °C	50 °C
	650 mA	tc	69 °C	78 °C
		Lifetime	>100,000 h	95,000 h
	> 650 – 700 mA	tc	70 °C	80 °C
		Lifetime	>100,000 h	89,000 h
LC 38/650-1050/42 o4a NF SC EXC3	> 700 – 800 mA	tc	73 °C	83 °C
		Lifetime	>100,000 h	77,000 h
	> 800 – 905 mA	tc	77 °C	86 °C
		Lifetime	>100,000 h	60,000 h
	> 905 – 1,050 mA	tc	77 °C	87 °C
		Lifetime	>100,000 h	50,000 h

Expected lifetime for independent use

Type	Output current	ta	45 °C	50 °C
	650 mA	tc	77 °C	82 °C
		Lifetime	78,000 h	73,000 h
	> 650 – 700 mA	tc	79 °C	84 °C
		Lifetime	70,000 h	68,000 h
LC 38/650-1050/42 o4a NF SC EXC3	> 700 – 800 mA	tc	82 °C	85 °C
		Lifetime	60,000 h	58,000 h
	> 800 – 905 mA	tc	86 °C	87 °C
		Lifetime	50,000 h	48,000 h
	> 905 – 1,050 mA	tc	87 °C	87 °C
		Lifetime	40,000 h	40,000 h

The LED driver is designed for a lifetime stated above under reference conditions and with a failure probability of less than 10 %.

The relation of tc to ta temperature depends also on the luminaire design.

If the measured tc temperature is approx. 5 K below tc max., ta temperature should be checked and eventually critical components (e.g. ELCAP) measured. Detailed information on request.

According to IEC 60598 – 1 mounting surface temperature is limited to max. 90 °C.

For output power > 34 W, the maximum ambient temperature is limited to 45° C for SR applications.

3. Installation / wiring

3.1 Circuit diagram

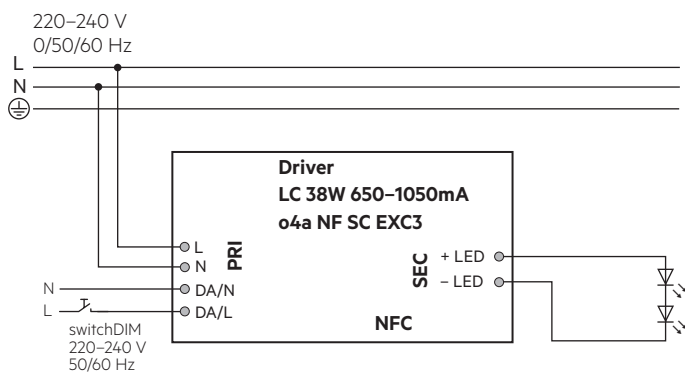
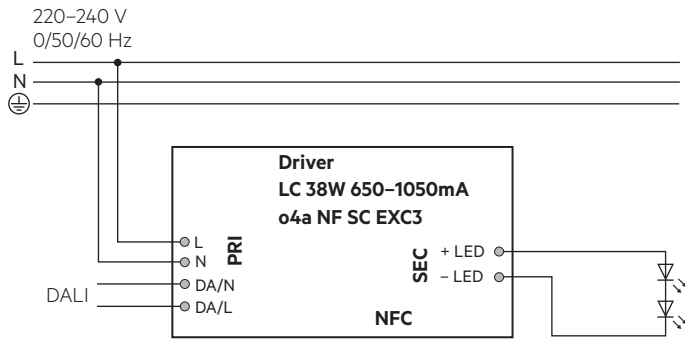

3.2 Wiring type and cross section

For wiring use stranded wire with ferrules or solid wire from 0.2–1.5 mm². Strip 8.5–9.5 mm of insulation from the cables to ensure perfect operation of the push-wire terminals. Use one wire for each terminal connector only.

LED module/LED driver/supply

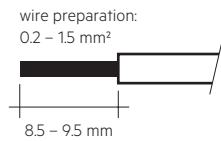

3.3 Loose wiring

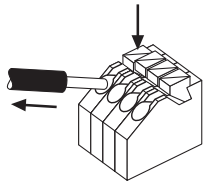

Press down the "push button" and remove the cable from front.

3.4 Fixing conditions when using as independent Driver with Clip-On

Dry, acidfree, oilfree, fatfree. It is not allowed to exceed the maximum ambient temperature (t_a) stated on the device. Minimum distances stated below are recommendations and depend on the actual luminaire. Is not suitable for fixing in corner.

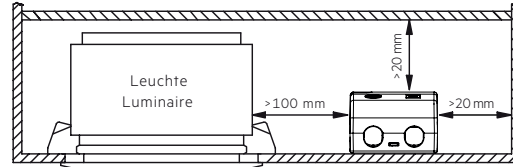

3.5 Wiring guidelines

- The cables should be run separately from the mains connections and mains cables to ensure good EMC conditions.
- The LED wiring should be kept as short as possible to ensure good EMC. The max. secondary cable length is 2 m (4 m circuit), this applies for LED output.
- To comply with the EMC regulations run the secondary wires (LED module) in parallel.
- Secondary switching is not permitted.
- The LED driver has no inverse-polarity protection on the secondary side. Wrong polarity can damage LED modules with no inverse-polarity protection.
- Wrong wiring of the LED driver can lead to malfunction or irreparable damage.
- To avoid the damage of the Driver, the wiring must be protected against short circuits to earth (sharp edged metal parts, metal cable clips, louver, etc.).

3.6 Replace LED module

1. Mains off
2. Remove LED module
3. Wait for 30 seconds
4. Connect LED module again

Hot plug-in or secondary switching of LEDs is not permitted and may cause a very high current to the LEDs.

3.7 Installation note

Max. torque at the clamping screw: 0.5 Nm / M4

4. Electrical values

4.1 Operating window

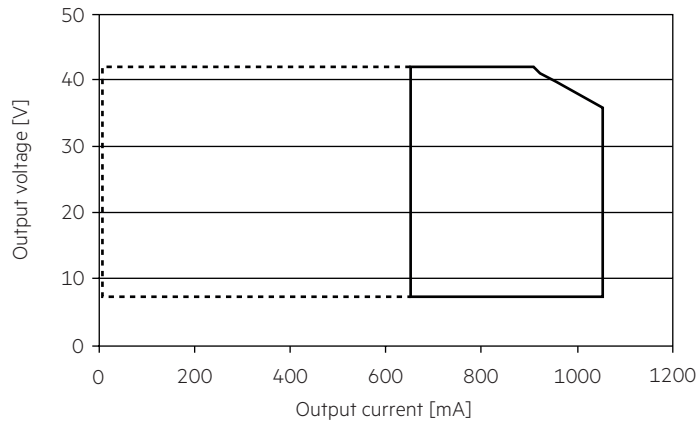

- Operating window 100 %
- - - - - Operating window dimmed

Make sure that the LED driver is operated within the given window under all operating conditions. Special attention needs to be paid at dimming and DC emergency operation as the forward voltage of the connected LED modules varies with the dimming level, due to the implemented amplitude dimming technology. Coming below the specified minimum output voltage of the LED driver may cause the device to shut-down. See chapter "6.11 Light level in DC operation" for more information.

4.2 Efficiency vs load

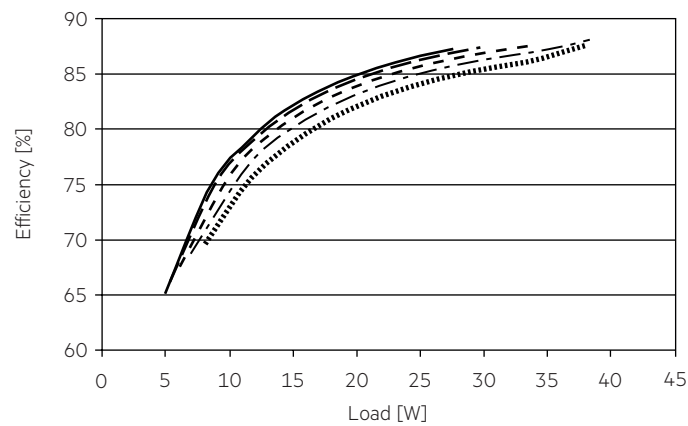

- 650 mA
- - - 700 mA
- . - . 800 mA
- - - - 905 mA
- 1050 mA

4.3 Power factor vs load

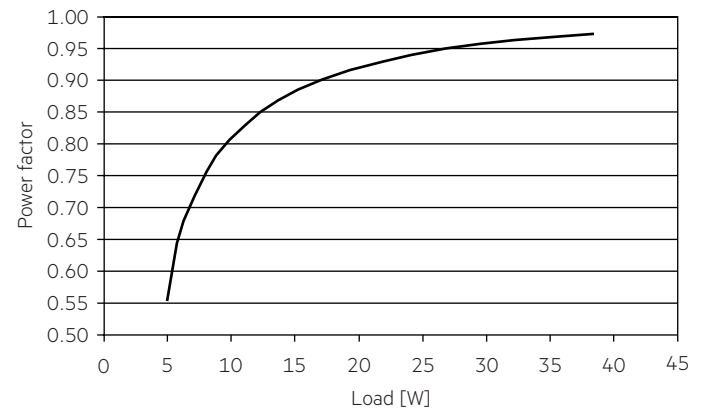

4.4 THD vs load

THD without harmonic < 5 mA (0.6 %) of the input current:

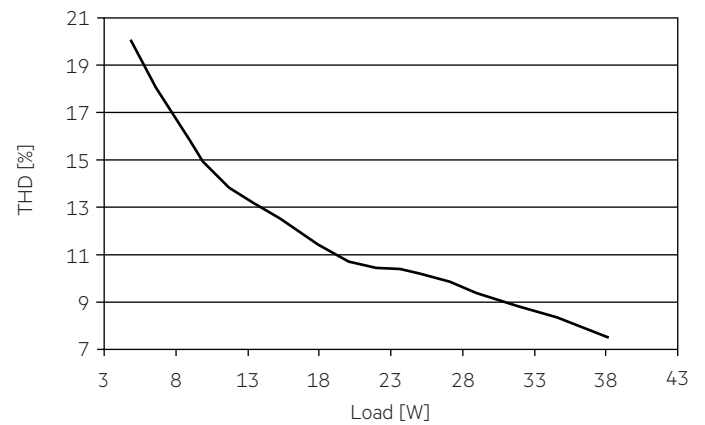

100 % load corresponds to the max. output power (full load) according to the table on page 3.

4.8 Maximum loading of automatic circuit breakers in relation to inrush current

Automatic circuit breaker type	C10	C13	C16	C20	B10	B13	B16	B20	Inrush current	
									I_{max}	time
Installation \emptyset	1.5 mm ²	1.5 mm ²	2.5 mm ²	4 mm ²	1.5 mm ²	1.5 mm ²	2.5 mm ²	4 mm ²		
LC 38/650-1050/42 o4a NF SC EXC3	36	46	56	70	35	46	56	70	5.33 A	42 μ s

These are max. values calculated out of inrush current! Please consider not to exceed the maximum rated continuous current of the circuit breaker.

Calculation uses typical values from ABB series S200 as a reference.

Actual values may differ due to used circuit breaker types and installation environment.

4.9 Harmonic distortion in the mains supply (at 230 V / 50 Hz and full load) in %

	THD					
	3.	5.	7.	9.	11.	
LC 38/650-1050/42 o4a NF SC EXC3	< 9	< 8	< 3	< 4	< 4	< 3

Acc. to 6100-3-2. Harmonics < 5 mA or < 0.6 % (whatever is greater) of the input current are not considered for calculation of THD.

5. Software / Programming / Interfaces

5.1 Software / programming

With appropriate software and interface different functions can be activated and various parameters can be configured in the LED driver. The Driver supports the following software and interfaces:

Software / hardware for configuration:

- companionSUITE (deviceGENERATOR, deviceCONFIGURATOR, deviceANALYSER)
- masterCONFIGURATOR

Interfaces for data transfer:

- NFC
- Control input DALI
- Control input switchDIM

5.2 Nearfield communication (NFC)

The NFC Interface allows wireless communication with the LED driver. This interface offers the option to write configuration and to read configuration, errors and events with the companionSUITE. A correct communication between the LED driver and the NFC antenna can only be guaranteed if the antenna is placed directly on the Driver. Any material placed between the LED driver and the NFC antenna can cause a deterioration of the communication quality. After programming the device via NFC power up the device one time for one second till the deviceANALYSER can read out the parameters. We recommend the use of following NFC antenna:
www.tridonic.com/nfc-readers

NFC is complied with ISO/IEC 15963 standard.

5.3 Control input DALI

The control input is non-polar for digital control signals (DALI). The control signal is not SELV. The control cable has to be installed in accordance to the requirements of low voltage installations.

Digital control with:

- DALI signal: 16 bit

Dimming is realized by amplitude dimming.

5.4 Control Input switchDIM

A standard pushbutton (switchDIM) can be wired on the terminals (DA/N and DA/L).

Integrated switchDIM function allows a direct connection of a pushbutton for dimming and switching.

Brief push (< 0.6 s) switches LED driver ON and OFF. The dimm level is saved at power-down and restored at power-up.

When the pushbutton is held, LED modules are dimmed. After repush the LED modules are dimmed in the opposite direction.

In installations with LED drivers with different dimming levels or opposite dimming directions (e.g. after a system extension), all LED drivers can be synchronized to 50 % dimming level by a 10 s push.

Use of pushbutton with indicator lamp is not permitted.

6. Functions

⦿ companionSUITE:

DALI-USB, NFC

The companionSUITE with deviceGENERATOR, deviceCONFIGURATOR and deviceANALYSER is available via our WEB page:









<https://www.tridonic.com/com/en/products/companionsuite.asp>

◇ masterCONFIGURATOR:

DALI-USB

The masterCONFIGURATOR is available via our WEB page:

<https://www.tridonic.com/com/en/software-masterconfigurator.asp>

Icon	Function	NFC	DALI-2
	OEM Identification	⦿	⦿ ◇
	OEM GTIN	⦿	⦿ ◇
	Luminaire data	⦿	⦿ -
	Label information	⦿	⦿ ◇
	LED current	⦿	⦿ ◇
	Device operating mode	⦿	⦿ ◇
	Factory reset	⦿	- -
	switchDIM fading	⦿	⦿ ◇
	corridorFUNCTION	⦿	⦿ ◇
	Constant light output (CLO)	⦿	⦿ ◇
	DC level	⦿	⦿ ◇
	Enhanced power on level (ePOL)	⦿	⦿ ◇
	DALI default parameters	⦿	⦿ ◇
	Scenes and groups	⦿	⦿ ◇
	Power-up fading	⦿	⦿ -
	Dimming curve	⦿	⦿ -
	deviceKEY	⦿	⦿ -
	Energy reports	⦿	⦿ -

6.1 OEM Identification



The OEM (Original Equipment Manufacturer) can set his own identification number.

DALI Part 251: Memory bank 1 extension.

6.2 OEM GTIN



The Original Equipment Manufacturer (OEM) can set his own Global Trade Item Number (GTIN).

DALI Part 251: Memory bank 1 extension.

6.3 Luminaire data



This function provides the asset management with accurate data about the luminaire.

DALI Part 251: Memory bank 1 extension.

6.4 Label information



In production, an individual label can be printed out for each device.

For this there are different default values (Batch No., Production Date, ...) available.

In addition, you can use these two text input fields to insert your own luminaire information and print it out.

6.5 LED current



The LED output current must be adapted to the connected LED module.

The value is limited by the current range of the respective device.

6.6 Device operating mode



A Tridonic driver supports several control signals.

These control signals are automatically detected and the mode is adapted.

If only one special device mode is required, this mode can be fixed here.

“Automatic detection” is the default setting.

6.7 Factory reset



This device supports the function to reset all parameters back to factory defaults.

6.8 switchDIM fading



Here you can set the fade time of the control gear when using switchDIM.

6.9 corridorFUNCTION



A motion detector (corridorFUNCTION) can be wired on the terminals (DA/N and DA/L).

With the corridorFUNCTION and a commercially available motion detector, it is easy to adapt the lighting in one area to its use.

That is, when the area is entered by a person, the lighting dims instantly to a certain brightness and is available in desired strength.

After the area is left by the person, the brightness dims slowly to a smaller value or switches off completely.

The individual parameters of the desired profile, such as brightness values or delay times, can be adjusted flexibly and individually.

To activate the corridorFUNCTION without using software a voltage of 230 V has to be applied at the DA/N and DA/L connection.

The unit will then switch automatically to the corridorFUNCTION.

corridorFUNCTION is a very simple tool for controlling gears with conventional pushbuttons or motion sensors.

To ensure correct operation a sinusoidal mains voltage with a frequency of 50 Hz or 60 Hz is required at the control input.

Special attention must be paid to achieving clear zero crossings.

Serious mains faults may impair the operation of corridorFUNCTION.

Note:

By using corridorFUNCTION programming and monitoring via DALI is always possible.

6.10 Constant Light Output (CLO)



With this function the light output of the LED module can be kept equal over the lifetime.

The light output of an LED module reduces over the course of its lifetime. The Constant Light Output (CLO) function compensates for this natural decline by constantly increasing the output current of the LED driver throughout its lifetime.

CLO shall be achieved by limitation of the LED current at the commissioning of the LED driver and providing a linear interpolation of the current over the time, depending on the data points given by the user.

6.11 Light level in DC operation



In emergency light systems with a central battery supply the DC recognition function uses the input voltage to detect if emergency mode is present.

The LED driver then automatically switches to DC mode and dims the light to the defined DC level.

Without DC recognition different and more complex solutions would have to be applied in order to detect emergency mode.

DC recognition is integrated in the device as standard.

No additional commissioning is necessary for activation.



This is a safety-relevant parameter.

The setting is relevant for the dimensioning of the central battery system.

The LED driver is designed to operate on DC voltage and pulsed DC voltage. For a reliable operation, make sure that also in DC emergency operation the LED driver is run within the specified conditions as stated in chapter "4.1 operating window".

Light output level in DC operation: programmable 15 – 100 %
(factory default = 15 %, EOF_i = 0.13).

The voltage-dependent input current of Driver incl. LED module is depending on the used load.

The voltage-dependent no-load current of Driver (without or defect LED module) is for:

AC: < 30 mA

DC: < 1.94 mA

6.12 Enhanced power on level (ePOL)



The Enhanced Power On Level parameter defines the power level that is set automatically when power is restored after a power failure.

The Enhanced Power On Level can be set to a fixed value (0 – 100 %) or can recall the memory value.

The memory value is the last value the LED driver was set to before the power failure.

This value applies not only in DALI device operating mode, but also in the device operating mode switchDIM.

6.13 DALI default parameters



In order for all luminaires to react the same for each operation (switching, dimming, scene recall ...), these values must be set the same.

These DALI standard parameters are supported by every DALI-2 device.

6.14 Scenes and groups



Each device can be a member of up to 16 groups.

Also, 16 different scene values can be stored in each device.

6.15 Power-up fading



The power-up function offers the opportunity to modify the on behavior.

The time for fading on can be adjusted in a range of 0.2 to 16 seconds.

According to this value, the device dims from 0 % up to the power-on level.

By factory default no fading time is set (= 0 seconds).

6.16 Dimming curve



DALI:

The desired dimming behaviour is selected via two different dimming curves (logarithmic or linear).

The default setting of the dimming behaviour is logarithmic.

6.17 deviceKEY



With this function, individual device functions can be protected from unauthorized changes by a password.

6.18 Energy reporting



This function provides the information related to energy reporting accessible through memory banks in this driver. Several functions and values could be read out to gain access in Content management systems. Report and values for Active power, Active Energy and many more can be read out.

7. Protective features

7.1 Overtemperature protection

The LED driver is protected against temporary thermal overheating. If the temperature limit is exceeded the output current of the LED module(s) is reduced. The temperature protection is activated above $t_{c\ max}$. The activation temperature differs depending on the LED load. On DC operation this function is deactivated to fulfill emergency requirements.

7.2 Short-circuit behaviour

In case of a short-circuit at the LED output the LED output is switched off. After restart of the LED driver the output will be activated again. The restart can either be done via mains reset or via interface (DALI).

7.3 No-load operation

The LED driver will not be damaged in no-load operation. The output will be deactivated and is therefore free of voltage. When connecting an LED load, restart the device to activate the LED output.

7.4 Overload protection

If the maximum load is exceeded by a defined internal limit, the LED driver turns off the LED output. After restart of the LED driver the output will be activated again. The restart can either be done via mains reset or via interface (DALI).

7.6 Insulation between terminals

Insulation	Mains	NTC / LED	DALI
Mains	–	double	basic
NTC / LED	double	–	double
DALI	basic	double	–

basic ... represents basic insulation.

double ... represents double or reinforced insulation.

8. Miscellaneous

8.1 Insulation and electric strength testing of luminaires

Electronic devices can be damaged by high voltage. This has to be considered during the routine testing of the luminaires in production.

According to IEC 60598-1 Annex Q (informative only!) or ENEC 303-Annex A, each luminaire should be submitted to an insulation test with 500 V_{DC} for 1 second. This test voltage should be connected between the interconnected phase and neutral terminals and the earth terminal. The insulation resistance must be at least 2 MΩ.

As an alternative, IEC 60598-1 Annex Q describes a test of the electrical strength with 1500 V_{AC} (or 1.414 x 1500 V_{DC}). To avoid damage to the electronic devices this test must not be conducted.

The equipotential terminal is used to connect the heat sink and the LED driver to reduce transients.

8.2 Conditions of storage and use

Humidity: 5% up to max. 85%,
not condensed
(max. 56 days/year at 85%)

Storage temperature: -40 °C up to max. +80 °C

The devices have to be acclimatised to the specified temperature range (ta) before they can be operated.

The LED driver is declared as inbuilt LED controlgear, meaning it is intended to be used within a luminaire enclosure. If the product is used outside a luminaire, the installation must provide suitable protection for people and environment (e.g. in illuminated ceilings).

8.3 Maximum number of switching cycles

All LED driver are tested with 50,000 switching cycles. The actually achieved number of switching cycles is significantly higher.

8.4 Additional information

Additional technical information at www.tridonic.com → Technical Data

Lifetime declarations are informative and represent no warranty claim. No warranty if device was opened.

X-ON Electronics

Largest Supplier of Electrical and Electronic Components

Click to view similar products for [LED Power Supplies](#) category:

Click to view products by [Tridonic](#) manufacturer:

Other Similar products are found below :

[PIFC-K250F](#) [PITB-K222A](#) [AC-A60VD24H2.5](#) [ALD-514012PJ134](#) [PWD-60-1-70-P](#) [EUG-200S210DT](#) [ESS030W-1050-21](#) [BPOXL 4-12-035](#) [ESS010W-0180-42](#) [ESS010W-0350-24](#) [ESS010W-0200-42](#) [SLM140W-1.05-130-ZA](#) [ESS015W-0700-18](#) [HVG-240-48AB](#) [HVG-240-54AB](#) [OTE 25/220-240/700 PC](#) [DAL30W-0600-42-T](#) [HVG-320-48AB](#) [CNB30W-0600-42-CAS](#) [87500757](#) [I-SELECT 2 PLUG 2100MA BL](#) [LCU 48V 75W DC-STR FO](#) [LC 45 W 500-1400 MA FLEXC SC EXC](#) [I-SELECT 2 PLUG 2000MA BL](#) [LC 50/200-350/170 FLEXCC LP](#) [SNC3](#) [LCO 14/100-500/38 O4A NF C EXC3](#) [LC 28W 300-700MA 42 FLEXC NF SC EXC3](#) [LC 44/1050/42 FIXC SRL ADV2](#) [LCA 60W 900-1750MA ONE4ALL C PRE](#) [LC 8/180/44 FIXC SR SNC2](#) [LC 19/200-350/54 FLEXC LP SNC4](#) [BXDR-PS-75BS-E116D-01-A](#) [LC 30/500/54 FIXC SR SNC2](#) [LCA 60W 24V ONE4ALL SC PRE SP](#) [LC 60W 75-330MA 310V FLEXC NF H16 EXC4](#) [LC 8/180/42 FIXC PC SR SNC2](#) [LC 10/350/29 FIXC SR SNC2](#) [LC 25/500/43 FIXC SR SNC2](#) [LC 50/100-400/140 PO4A NF H16 PRE3](#) [LC 25/600/42 FIXC SRL ADV2](#) [LCO 24/200-1050/39 NF C ADV3](#) [ELEMENT 35/220...240/900 G3](#) [LC 25W 350-1050MA FLEXC SR EXC](#) [LC 60/700/86 FIXC SR SNC2](#) [LC 35W 24 ONE4ALL IP PRE](#) [BXDR-PS-25BS-E107D-01-A](#) [LC 17W 250-700MA FLEXC SR EXC](#) [LC 15W 350MA FIXC C SNC](#) [LC 14W 700MA FIXC PC SR SNC2](#) [LC 200W 24V SC SNC](#)