



Driver LC 50W 350–1050mA 0-10V NFC AUX Ip EXC2 UNV

Linear excite NFC series (US applications)

Product description

- Constant current LED driver
- Dimmable via 0 ... 10 V interface (incl. stand-by)
- Dimming range 1 – 100 % (incl. stand-by)
- UL8750 with class 2 output based on UL1310
- UL Listed Class P
- FCC Part 15, Class A
- Meets UL 8750 SF3.1 Isolation
- Adjustable output current between 350 and 1,050 mA via NFC
- Max. output power 50 W
- Up to 87.6 % efficiency
- Meets Strictest Flicker Free Performance Standards
- Nominal lifetime up to 100,000 h
- 5 years guarantee (Conditions at www.tridonic.com)

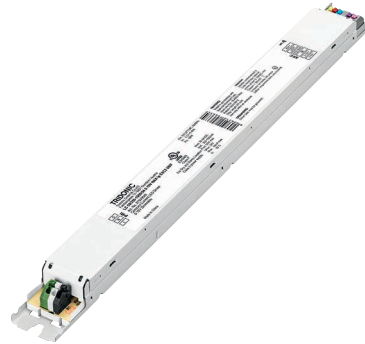

Housing properties

- Casing: metal, white
- Type of protection IP20
- Dry and damp location

Functions

- Adjustable output current in 1-mA-steps (NFC)
- 24 V AUX output
- Fade-off time programmable
- Protective features (overtemperature, short-circuit, overload, no-load, input voltage range)

Benefits

- Operating windows for maximum compatibility
- Added energy savings with dimming via 0 ... 10 V interface
- Configurable via NFC
- Meets California Title 24
- Tailor your dimming response with either Linear, Logarithmic or Square Dimming Curves

Typical applications

- For linear/area lighting in office, education, healthcare, and general lighting applications



Standards, page 4



Driver LC 50W 350–1050mA 0-10V NFC AUX Ip EXC2 UNV

Linear excite NFC series (US applications)

Technical data

Rated supply voltage	120 – 277 V
AC voltage range	108 – 305 V
Mains frequency	50 / 60 Hz
Typ. current (at 120 V, 60 Hz, full load) ^{① ②}	488 mA
Typ. current (at 277 V, 60 Hz, full load) ^{① ②}	217 mA
Leakage current (at 120 V, 60 Hz, full load) ^{③ ②}	< 750 μ A
Leakage current (at 277 V, 60 Hz, full load) ^{③ ②}	< 750 μ A
Max. input power (at 120 V, 60 Hz, full load)	59.0 W
Max. input power (at 277 V, 60 Hz, full load)	57.1 W
Typ. efficiency (at 120 V, 60 Hz, full load) ^④	85.1 %
Typ. efficiency (at 277 V, 60 Hz, full load) ^④	87.6 %
λ (at 120 V, 60 Hz, full load) ^⑤	0.99
λ (at 277 V, 60 Hz, full load) ^⑤	0.95
Typ. power consumption on stand-by (at 120 V, 60 Hz) ^⑥	< 0.5 W
Typ. power consumption on stand-by (at 277 V, 60 Hz) ^⑥	< 0.5 W
Typ. input current in no-load operation (at 120 V, 60 Hz)	16 mA
Typ. input current in no-load operation (at 277 V, 60 Hz)	30 mA
Typ. input power in no-load operation (at 120 V, 60 Hz)	1.44 W
Typ. input power in no-load operation (at 277 V, 60 Hz)	1.28 W
In-rush current (peak / duration at 120 V)	4 A / 27 μ s
In-rush current (peak / duration at 277 V)	15 A / 19 μ s
THD (at 120 V, 60 Hz, full load) ^⑦	< 10 %
THD (at 277 V, 60 Hz, full load) ^⑦	< 20 %
Starting time (at 120 V, full load) ^⑧	\leq 500 ms
Starting time (at 277 V, full load) ^⑧	\leq 500 ms
Turn off time (full load)	< 30 ms
Hold time (power failure, full load)	< 20 ms
Output current tolerance ^{⑨ ⑩}	\pm 5 %
Max. output current peak (non-repetitive)	\leq output current + 5 %
Output LF current ripple (< 120 Hz)	\pm 5 %
Output P_{STLM} (at full load)	\leq 1
Output SVM (at full load)	\leq 0.4
Max. output voltage	60 V
Dimming range	1 – 100 %
Mains surge capability (between L - N)	2 kV
Mains surge capability (between L/N - PE)	2.5 kV
Surge voltage at output side (against PE)	500 V
Type of protection	IP20
Lifetime	up to 100,000 h
Guarantee (conditions at www.tridonic.com)	5 years
Dimensions L x W x H	360 x 30 x 21 mm

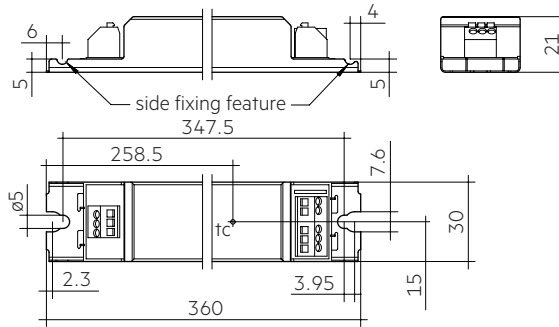

Ordering data

Type	Article number	Packaging carton	Packaging, low volume	Packaging, high volume	Weight per pc.
LC 50/350-1050/54 0-10V NAX Ip EXC2 UNV	87500849	10 pc(s).	180 pc(s).	1,260 pc(s).	0.284 kg

Specific technical data

Type	Output current ^④	Min. forward voltage	Max. forward voltage	Max. output power (at 120 V, 60 Hz, full load)	Typ. power consumption (at 120 V, 60 Hz, full load)	Typ. current consumption (at 120 V, 60 Hz, full load)	Max. output power (at 277 V, 60 Hz, full load)	Typ. power consumption (at 277 V, 60 Hz, full load)	Typ. current consumption (at 277 V, 60 Hz, full load)	tc temperature ^⑥	Ambient temperature ta max.
LC 50/350-1050/54 0-10V NAX Ip EXC2 UNV	350 mA	20 V	54.0 V	18.9 W	22.0 W	185 mA	18.9 W	22.9 W	103 mA	60 °C	-25 ... +55 °C
	400 mA	20 V	54.0 V	21.8 W	25.1 W	211 mA	21.8 W	25.3 W	110 mA	60 °C	-25 ... +55 °C
	450 mA	20 V	54.0 V	24.2 W	27.8 W	233 mA	24.2 W	28.6 W	121 mA	60 °C	-25 ... +55 °C
	500 mA	20 V	54.0 V	27.1 W	31.3 W	261 mA	27.1 W	31.4 W	129 mA	60 °C	-25 ... +55 °C
	550 mA	20 V	54.0 V	29.8 W	34.0 W	282 mA	29.8 W	34.3 W	139 mA	65 °C	-25 ... +55 °C
	600 mA	20 V	54.0 V	32.7 W	36.7 W	305 mA	32.7 W	37.3 W	149 mA	65 °C	-25 ... +55 °C
	650 mA	20 V	54.0 V	35.0 W	39.8 W	331 mA	35.0 W	39.5 W	156 mA	65 °C	-25 ... +55 °C
	700 mA	20 V	54.0 V	38.1 W	44.0 W	366 mA	38.1 W	43.1 W	168 mA	65 °C	-25 ... +55 °C
	750 mA	20 V	54.0 V	40.8 W	46.5 W	386 mA	40.8 W	45.8 W	178 mA	65 °C	-25 ... +55 °C
	800 mA	20 V	54.0 V	43.5 W	49.1 W	411 mA	43.5 W	49.0 W	188 mA	65 °C	-25 ... +55 °C
	850 mA	20 V	54.0 V	46.2 W	52.9 W	443 mA	46.2 W	51.8 W	198 mA	70 °C	-25 ... +55 °C
	900 mA	20 V	54.0 V	48.6 W	55.9 W	462 mA	48.6 W	54.5 W	207 mA	70 °C	-25 ... +55 °C
	950 mA	20 V	52.6 V	49.8 W	57.2 W	473 mA	49.8 W	56.2 W	213 mA	70 °C	-25 ... +55 °C
	1,000 mA	20 V	50.0 V	50.0 W	57.7 W	478 mA	50.0 W	56.3 W	213 mA	75 °C	-25 ... +55 °C
	1,050 mA	20 V	47.6 V	50.0 W	57.8 W	479 mA	50.0 W	57.0 W	216 mA	75 °C	-25 ... +55 °C

① Valid at 100 % dimming level.

② Depending on the selected output current.

③ With load on AUX port higher.

④ The table only lists a number of possible operating points but does not cover each single point. The output current can be set within the total value range in 1-mA-steps.

⑤ Output current is mean value.

⑥ 5 years guarantee.

1. Standards

UL 8750
CSA C22.2
FCC Part 15, Class A

Product not designed for European Economic Area.

This device complies with Part 15 of the FCC Rules. Operation is subject to the following two conditions:

- (1) this device may not cause harmful interference, and
- (2) this device must accept any interference received, including interference that may cause undesired operation.

2. Thermal details and lifetime

2.1 Expected lifetime

Expected lifetime 120 V

Type	Output current	ta	45 °C / 113 °F	50 °C / 122 °F	55 °C / 131 °F
LC 50/350-1050/54 0-10V NAX Ip EXC2 UNV	350 – 500 mA	tc	50 °C / 122 °F	55 °C / 131 °F	60 °C / 140 °F
		Lifetime	> 100,000 h	> 100,000 h	> 100,000 h
	> 500 – 800 mA	tc	55 °C / 131 °F	60 °C / 140 °F	65 °C / 149 °F
		Lifetime	> 100,000 h	> 100,000 h	> 100,000 h
	> 800 – 950 mA	tc	60 °C / 140 °F	65 °C / 149 °F	70 °C / 158 °F
		Lifetime	> 100,000 h	> 100,000 h	95,000 h
	> 950 – 1,050 mA	tc	65 °C / 149 °F	70 °C / 158 °F	75 °C / 167 °F
		Lifetime	> 100,000 h	95,000 h	70,000 h

Expected lifetime 277 V

Type	Output current	ta	45 °C / 113 °F	50 °C / 122 °F	55 °C / 131 °F
LC 50/350-1050/54 0-10V NAX Ip EXC2 UNV	350 – 500 mA	tc	50 °C / 122 °F	55 °C / 131 °F	60 °C / 140 °F
		Lifetime	> 100,000 h	> 100,000 h	> 100,000 h
	> 500 – 800 mA	tc	55 °C / 131 °F	60 °C / 140 °F	65 °C / 149 °F
		Lifetime	> 100,000 h	> 100,000 h	> 100,000 h
	> 800 – 950 mA	tc	60 °C / 140 °F	65 °C / 149 °F	70 °C / 158 °F
		Lifetime	> 100,000 h	> 100,000 h	> 100,000 h
	> 950 – 1,050 mA	tc	65 °C / 149 °F	70 °C / 158 °F	75 °C / 167 °F
		Lifetime	> 100,000 h	> 100,000 h	85,000 h

The LED driver is designed for a lifetime stated above under reference conditions and with a failure probability of less than 10 %.

3. Installation / wiring

3.1 Circuit diagram

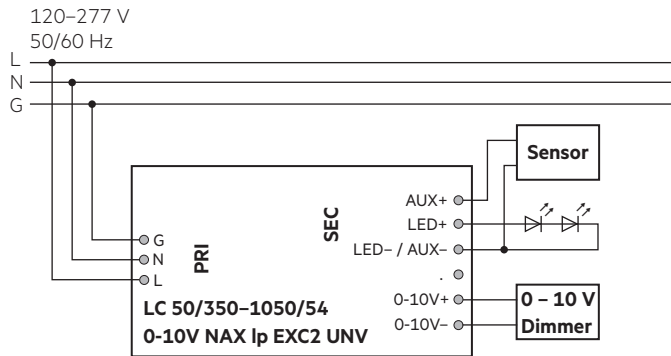

3.2 Wiring type and cross section

The wiring can be in stranded wires with ferrules or solid with a cross section of 0.2 – 1.5 mm² (AWG24 – 16).

Strip 8.5–9.5 mm (3/8 inch) of insulation from the cables to ensure perfect operation of the push-wire terminals.

Use one wire for each terminal connector only.

LED module/LED driver/supply

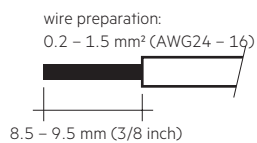

3.3 Loose wiring

Press down the “push button” and remove the cable from front.

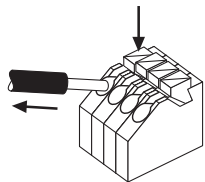

3.4 Wiring guidelines

- Run the secondary lines separately from the mains connections and lines to achieve good EMC performance.
- The max. secondary cable length is 2 m (4 m circuit).
- For good EMC performance, keep the LED wiring as short as possible.
- Secondary switching is not permitted.
- The LED driver has no inverse-polarity protection on the secondary side. Wrong polarity can damage LED modules with no inverse-polarity protection.
- Wrong wiring of the LED driver can lead to malfunction or irreparable damage.
- To avoid the damage of the Driver, the wiring must be protected against short circuits to earth (sharp edged metal parts, metal cable clips, louver, etc.).

3.5 Hot plug-in

Hot plug-in is not supported due to residual output voltage of > 0 V.

If a LED load is connected, the device has to be restarted before the output will be activated again.

This can be done via mains reset.

3.6 Earth connection

The earth connection is conducted as protection earth (PE). If the LED Driver will be earthed, protection earth (PE) has to be used. There is no earth connection required for the functionality of the LED driver.

Earth connection is recommended to improve following behaviour:

- Electromagnetic interferences (EMI)
- Transmission of mains transients to the LED output

In general it is recommended to earth the LED driver if the LED module is mounted on earthed luminaire parts respectively heat sinks and thereby representing a high capacity against earth.

4. Electrical values

4.1 Operating window

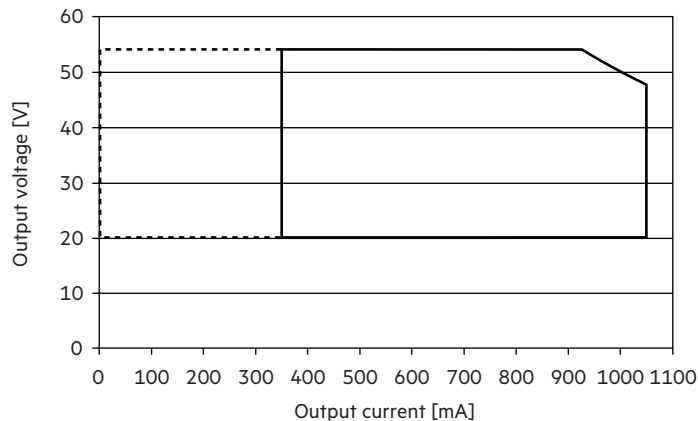

— Operating window 100 %
 - - - - - Operating window dimmed

Make sure that the LED driver is operated within the given window under all operating conditions. Special attention needs to be paid at dimming as the forward voltage of the connected LED modules varies with the dimming level, due to the implemented amplitude dimming technology. Coming below the specified minimum output voltage of the LED driver may cause the device to shut-down.

4.2 Efficiency vs load

120 V, 60 Hz:

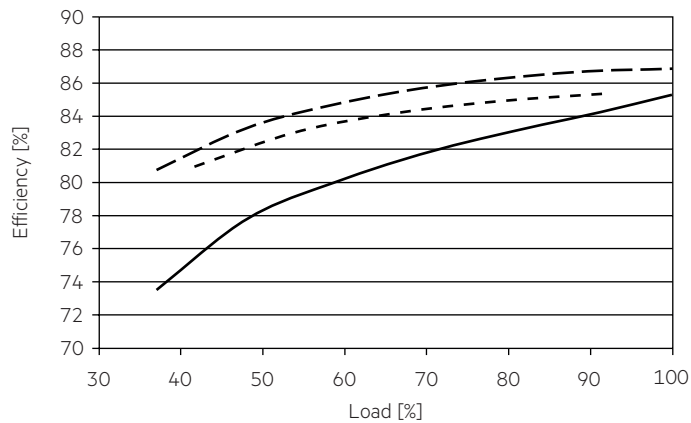

277 V, 60 Hz:

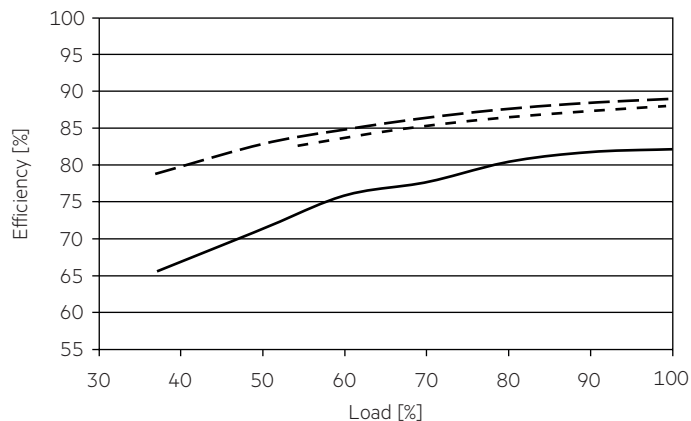

4.3 Power factor vs load

120 V, 60 Hz:

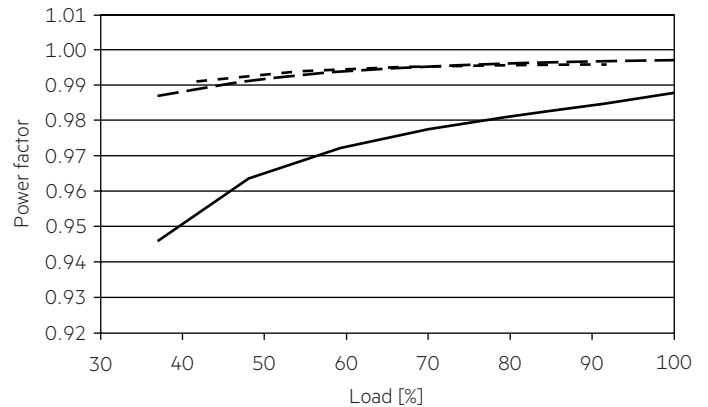

277 V, 60 Hz:

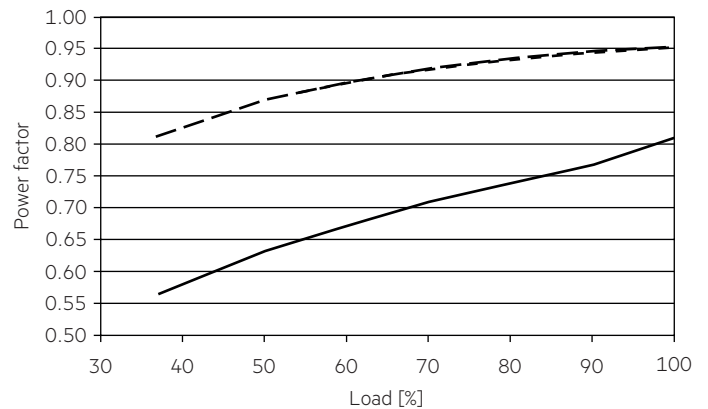

4.4 THD vs load (without harmonic < 5 mA or 0.6 % of the input current)

120 V, 60 Hz:

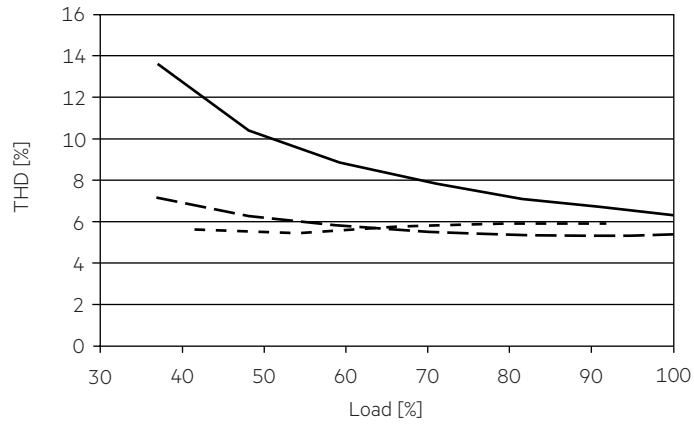

277 V, 60 Hz:

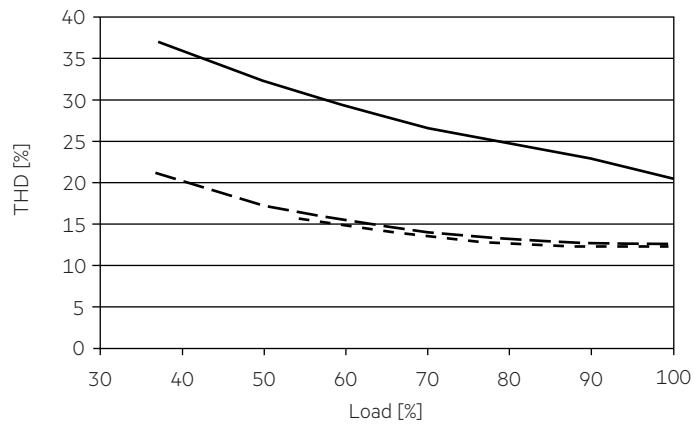

- 350 mA
- - - 930 mA
- · - · 1050 mA

100 % load corresponds to the max. output power (full load) according to the table on page 3.

4.5 Maximum loading of automatic circuit breakers in relation to inrush current

120 V, 60 Hz:

Automatic circuit breaker type	C10	C13	C16	C20	B10	B13	B16	B20	Inrush current
Installation Ø	1.5 mm ² / AWG16	1.5 mm ² / AWG16	2.5 mm ² / AWG14	2.5 mm ² / AWG14	1.5 mm ² / AWG16	1.5 mm ² / AWG16	2.5 mm ² / AWG14	2.5 mm ² / AWG14	I_{\max} time
LC 50/350-1050/54 0-10V NAX Ip EXC2 UNV	no limitation in relation to inrush current								4 A 27 µs

277 V, 60 Hz:

Automatic circuit breaker type	C10	C13	C16	C20	B10	B13	B16	B20	Inrush current
Installation Ø	1.5 mm ² / AWG16	1.5 mm ² / AWG16	2.5 mm ² / AWG14	2.5 mm ² / AWG14	1.5 mm ² / AWG16	1.5 mm ² / AWG16	2.5 mm ² / AWG14	2.5 mm ² / AWG14	I_{\max} time
LC 50/350-1050/54 0-10V NAX Ip EXC2 UNV	no limitation in relation to inrush current								15 A 19 µs

These are max. values calculated out of continuous current running the device on full load.

There is no limitation due to inrush current.

If load is smaller than full load for calculation only continuous current has to be considered.

4.6 Dimming

Dimming range is 1 to 100%.

The operating window shows the minimum reachable power in dimmed state.

4.7 Dimming characteristics

Control input (0 – 10 V)

Control input open	max. dimming level
Interface current range	120 µA ± 3 %
Max. permitted input voltage	± 16 V
Voltage range dimming	0 – 10 V [Ⓞ]
Input voltage = 0 V	stand-by
Input voltage < 1 V	min. dimming level [Ⓞ]
Input voltage > 10 V	max. dimming level [Ⓞ]

Interface supports current sink dimmers.

Interface is class 2.

[Ⓞ] See graph below (at full load):

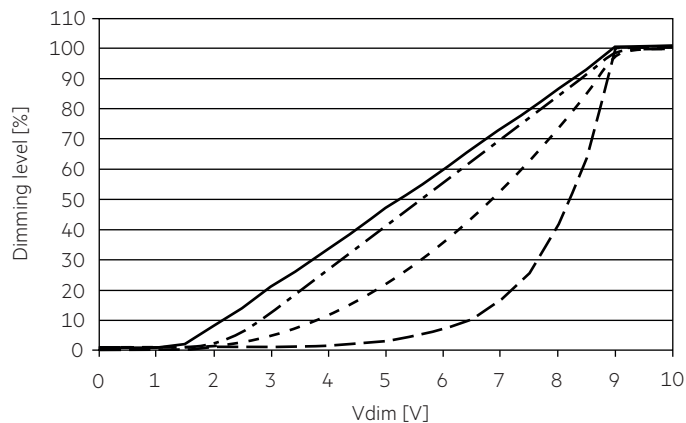

- Linear dimming curve (default)
- Logarithmic dimming curve
- - - - - Square dimming curve
- · - · - Linear with softstart dimming

Dimming profiles programmable via NFC.

4.8 Insulation between terminals

Insulation	Mains	AUX	-LED / +LED	0-10V
Mains	-	double	double	double
AUX	double	-	-	basic
-LED / +LED	double	-	-	basic
0-10V	double	basic	basic	-

basic ... represents basic insulation.

double ... represents double or reinforced insulation.

5. Software / Programming / Interfaces

5.1 Software / programming

With appropriate software and interface different functions can be activated and various parameters can be configured in the LED driver. The Driver supports the following software and interfaces:

Software / hardware for configuration:

- companionSUITE (deviceGENERATOR, deviceCONFIGURATOR, deviceANALYSER)

Interfaces for data transfer:

- NFC

5.2 Nearfield communication (NFC)

The NFC Interface allows wireless communication with the LED driver. This interface offers the option to write configuration and to read configuration, errors and events with the companionSUITE. A correct communication between the LED driver and the NFC antenna can only be guaranteed if the Driver is directly placed on the antenna. Any material placed between the LED driver and the NFC antenna can cause a deterioration of the communication quality. We recommend the use of following NFC antennas: www.tridonic.com/nfc-readers







NFC is compliant with ISO/IEC 15693 standard.

6. Functions

☉ companionSUITE:

NFC

The companionSUITE with deviceGENERATOR, deviceCONFIGURATOR and deviceANALYSER is available via our WEB page: <https://www.tridonic.com/com/en/products/companionsuite.asp>

Icon	Function	NFC
	OEM Identification	☉
	OEM GTIN	☉
	LED current	☉
	Dimming curve (0-10V)	☉
	Minimum level (0-10V)	☉
	Fade-off time (0-10V)	☉

6.1 LED current



The LED output current must be adapted to the connected LED module. The value is limited by the current range of the respective device.

6.2 Integrated auxiliary power supply (AUX)



Auxiliary power supply to connect external sensor.
For wiring see circuit diagram.
Output voltage: 16 – 25 V
Output current: 50 mA max.
AUX port is active in stand-by mode.

7. Protective features

7.1 Short-circuit behaviour

In case of a short-circuit at the LED output the LED output is switched off. After restart of the LED driver the output will be activated again. The restart can be done via mains reset.

7.2 No-load operation

The LED driver will not be damaged in no-load operation. The output will be deactivated and is therefore free of voltage. If a LED load is connected the device has to be restarted before the output will be activated again.

7.3 Overload protection

If the maximum load is exceeded by a defined internal limit, the LED driver turns off the LED output. After restart of the LED driver the output will be activated again. The restart can be done via mains reset.

7.4 Overtemperature protection

The LED driver is protected against temporary thermal overheating. Thermal overload protection is triggered if the maximum T_c temperature is exceeded by around 5 to 10 °C (see page 3) and the output current is slowly reduced. The LED driver can cool down with still having light.

8. Miscellaneous

8.1 Insulation and electric strength testing of luminaires

Electronic devices can be damaged by high voltage. This has to be considered during the routine testing of the luminaires in production.

According to UL 8750 (informative only!) each luminaire should be submitted to an insulation test with 500V_{DC}. The dielectric withstand test equipment shall employ a transformer of 500-VA or larger capacity and have a variable output voltage that is essentially sinusoidal or continuous direct current. The applied potential is to be increased from zero at a substantially uniform rate until the required test level is reached, and is to be held at that level for 1 minute.

As an alternative, UL8750 (informative only!) describes a test of the electrical strength with 2V AC + 1000V (or 1.414 x V DC). To avoid damage to the electronic devices this test must not be conducted.

8.2 Conditions of use and storage

Humidity: 5 % up to max. 85 %,
not condensed
(max. 56 days/year at 85 %)

Storage temperature: -40 °C up to max. +80 °C

The devices have to be acclimatised to the specified temperature range (t_a) before they can be operated.

The LED driver is declared as inbuilt LED controlgear, meaning it is intended to be used within a luminaire enclosure.

If the product is used outside a luminaire, the installation must provide suitable protection for people and environment (e.g. in illuminated ceilings).

8.3 Maximum number of switching cycles

All LED driver are tested with 50,000 switching cycles.
The actually achieved number of switching cycles is significantly higher.

8.4 Additional information

Additional technical information at www.tridonic.com → Technical Data

Lifetime declarations are informative and represent no warranty claim.
No warranty if device was opened.

X-ON Electronics

Largest Supplier of Electrical and Electronic Components

Click to view similar products for [LED Power Supplies](#) category:

Click to view products by [Tridonic](#) manufacturer:

Other Similar products are found below :

[ESS015W-1000-12](#) [PDA-WIFI](#) [PIFC-K250F](#) [PITB-K222A](#) [ALD-514012PJ134](#) [LB240S24KH](#) [LMH020-SPLC-0000-0000001](#) [79534](#) [79535](#)
[EUG-200S210DT](#) [ESS030W-1050-21](#) [ESS030W-0900-32](#) [BPOXL 4-12-035](#) [ESS010W-0350-24](#) [ESM060W-1400-42](#) [PDA080B-1A0G](#)
[PDA150B-S1A5G](#) [SLM140W-1.05-130-ZA](#) [ESS015W-0700-18](#) [EUD-150S350DVA](#) [LWA320-C420-ARK-B](#) [HVG-240-48AB](#) [HVG-320-](#)
[36AB](#) [HVG-320-54AB](#) [ELG-240-C1400AB](#) [EUK-150S105DV](#) [BXCS-12Z-N2P-B1-A](#) [BXPR-WN-01-A](#) [BXCS-12D-N2P-01-A](#) [BXCS-](#)
[12W-N2P-01-A](#) [LC 50W 200-350ML 170V FLEXC LP SNC4](#) [LC 25W 200-350ML 70V FLEXC LP SNC4](#) [LC 35W 200-350ML 121V](#)
[FLEXC LP SNC4](#) [LC 10W 250MA FIXC SC SNC2](#) [LC 35W 800MA FIXC SR ADV2](#) [LC 38W 900MA FIXC SR ADV2](#) [LC 34W 800MA](#)
[FIXC SC ADV2](#) [LC 44W 1050MA FIXC SC ADV2](#) [LC 38W 900MA 42V FIXC SRL ADV2](#) [HVG-320-48AB](#) [CNB50W-1200-42-CAS](#)
[CNB30W-0600-42-CAS](#) [LCI 100W 1400MA TEC C](#) [LCI 100W 2100MA TEC C](#) [LCI 150W 1750MA TEC C](#) [LCI 150W 2100MA TEC C](#)
[87500284](#) [87500447](#) [LC 50W 1200MA FIXC SR SNC](#) [87500554](#)