



Driver LC 53W 250-350mA flexC Ip ADV advanced series non-SELV

Product description

- Built-in constant current LED Driver
- New version DC operating with EL marking
- For luminaires of protection class I and protection class II
- Temperature protection as per EN 61347-2-13 C5e
- Adjustable output current between 250 and 350 mA
- Max. output power 53 W
- Up to 90.5 % efficiency
- Nominal lifetime up to 100,000 h
- 5 years guarantee (conditions at www.tridonic.com)



Housing properties

- Low-profile metal casing with white cover
- Type of protection IP20



Interfaces

- Terminal blocks: 45° push terminals

Functions

- Overload protection
- Short-circuit protection
- No-load protection
- Burst protection voltage 1 kV
- Surge protection voltage 1 kV (L to N)
- Surge protection voltage 2 kV (L/N to earth)
- Suitable for emergency lighting systems acc. to EN 50172

Typical applications

- For linear/area lighting in office applications



Standards, page 4

Wiring diagrams and installation examples, page 4

IP20 

Driver LC 53W 250-350mA flexC Ip ADV

advanced series non-SELV

Technical data

Rated supply voltage	220 – 240 V
AC voltage range	198 – 264 V
DC voltage range	176 – 280 V
Max. input current (at 230 V, 50 Hz, full load)	0.27 A
Typ. input current (at 230 V, 0 Hz, full load)	0.27 A
Leakage current (at 230 V, 50 Hz, full load)	< 450 µA
Mains frequency	0 / 50 / 60 Hz
Overvoltage protection	320 V AC, 48 h
Max. input power	57.5 W
Typ. power consumption (at 230 V, 50 Hz, full load)	57.5 W
Min. output power	17.8 W
Max. output power	53 W
Typ. efficiency (at 230 V / 50 Hz / full load) ^①	90.5 %
λ (at 230 V, 50 Hz, full load) ^②	0.95
Output current tolerance ^③	± 7.5 %
Max. output current peak ^③	≤ output current + 10 %
Max. output voltage	250 V
THD (at 230 V, 50 Hz, full load)	< 20 %
Output LF current ripple (< 120 Hz)	± 5 %
Starting time (at 230 V, 50 Hz, full load)	≤ 500 ms
Starting time (DC mode)	< 1,000 ms
Switchover time (AC/DC) ^④	< 500 ms
Turn off time (at 230 V, 50 Hz, full load)	≤ 0.5 s
Hold on time at power failure (output)	0 s
Ambient temperature ta (at lifetime 100,000 h)	40 °C
Storage temperature ts	-40 ... +80 °C
Lifetime	up to 100,000 h
Guarantee (conditions at www.tridonic.com)	5 years
Dimensions L x W x H	280 x 30 x 21 mm
Hole spacing D	268 mm

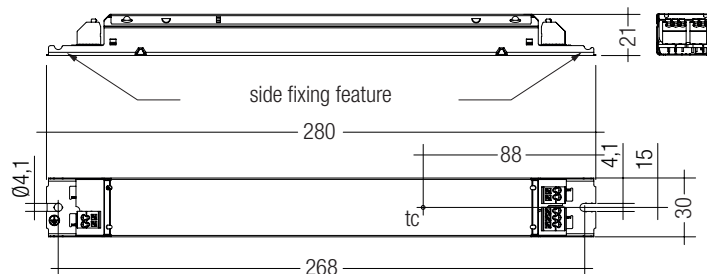

Ordering data

Type	Article number	Packaging, carton	Packaging, pallet	Weight per pc.
LC 53W 250-350mA flexC Ip ADV	28002468	50 pc(s).	900 pc(s).	0.169 kg

Specific technical data

Type	Output current ^②	Min. forward voltage	Max. forward voltage	Max. output power	Typ. power consumption (at 230 V, 50 Hz, full load)	Typ. current consumption (at 230 V, 50 Hz, full load)	Max. casing temperature tc	Ambient temperature ta max.	I-out select	Resistor ^⑤
LC 53W 250-350mA flexC Ip ADV	250 mA	71 V	150 V	37.5 W	40.9 W	186 mA	70 °C	-20 ... +55 °C	0-2	ADV Type A
	275 mA	71 V	150 V	41.3 W	45.0 W	203 mA	70 °C	-20 ... +50 °C	0-2	ADV Type B
	300 mA	71 V	150 V	45.0 W	49.5 W	222 mA	70 °C	-20 ... +50 °C	0-1	ADV Type A
	325 mA	71 V	150 V	48.8 W	54.0 W	242 mA	70 °C	-20 ... +50 °C	0-2	ADV Type C
	350 mA	71 V	150 V	52.5 W	57.5 W	256 mA	70 °C	-20 ... +50 °C	open	-

^① Test result at 350 mA.

^② Output current is mean value.

^③ Test result at 25 °C.

^④ Type A is a short circuit plug (0 Ω).

^⑤ Valid for immediate change of power supply type otherwise the starting time is valid.

Product description

- Ready-for-use resistor to set output current value
- Compatible with LED Driver serie LC flexC ADV; not compatible with I-SELECT (generation 1) and I-SELECT 2 (generation 2)
- Resistor is base insulated
- When using your own resistors, make sure the resistor must be insulated
- Resistor power 0.25 W
- Current tolerance $\pm 2\%$ additional to output current tolerance
- Hot plug of the resistor is not permitted
- For detailed current setting see table "Specific technical data" of the respective LED Driver and chapter 3.8 Current setting

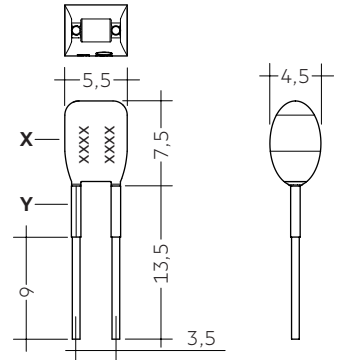

Ordering data

Type	Article number	Colour of X area	Colour of Y area	Marking	Resistor value	Packaging bag	Weight per pc.
ADV Plug Type A YL	28001771	Yellow	Yellow	A	0.0 Ω	10 pc(s).	0.001 kg
ADV Plug Type B YL	28001772	Yellow	Black	B	3.16 k Ω	10 pc(s).	0.001 kg
ADV Plug Type C YL	28001773	Yellow	Purple	C	28.7 k Ω	10 pc(s).	0.001 kg

1. Standards

EN 55015
EN 61000-3-2
EN 61000-3-3
EN 61347-1
EN 61347-2-13
EN 61547
EN 62384

According to EN 50172 for use in central battery systems
According to EN 60598-2-22 suitable for emergency lighting installations

2. Thermal details and lifetime

2.1 Expected lifetime

Expected lifetime				
Type	ta	40 °C	50 °C	60 °C
LC 53W 250-350mA flexC Ip ADV	tc	60 °C	70 °C	x
	Lifetime	100,000 h	50,000 h	x

The LED Driver is designed for a lifetime stated above under reference conditions and with a failure probability of less than 10 %.

The relation of tc to ta temperature depends also on the luminaire design. If the measured tc temperature is approx. 5 K below tc max., ta temperature should be checked and eventually critical components (e.g. ELCAP) measured. Detailed information on request.

3. Installation / wiring

3.1 Circuit diagram

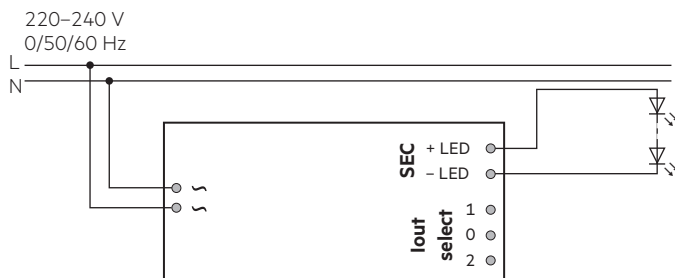

3.2 Wiring type and cross section

The wiring can be stranded wires with ferrules or rigid wires with a cross section of 0.5 – 1.5 mm². Strip 8.5 – 9.5 mm of insulation from the cables to ensure perfect operation of the push-wire terminals.

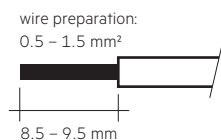

3.3 Release of the wiring

Press down the “push button” and remove the cable from front.

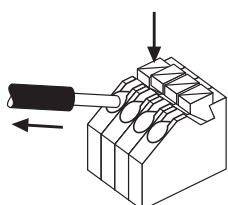

3.4 Installation instructions

The LED module and all contact points within the wiring must be sufficiently insulated against 3 kV surge voltage. Air and creepage distance must be maintained.

3.5 Wiring guidelines

- All connections must be kept as short as possible to ensure good EMI behaviour.
- Mains leads should be kept apart from LED Driver and other leads (ideally 5 – 10 cm distance)
- Max. length of output wires is 2 m.
- Incorrect wiring can damage LED modules.
- To avoid the damage of the Driver, the wiring must be protected against short circuits to earth (sharp edged metal parts, metal cable clips, louver, etc.).
- The current selection has to be installed in the accordance to the requirement of low voltage installation.

3.6 Replace LED module

1. Mains off
2. Remove LED module
3. Wait for 20 seconds
4. Connect LED module again

Hot plug-in or output switching of LEDs is not permitted and may cause a very high current to the LEDs.

3.7 Earth connection

The earth connection is conducted as protection earth (PE). The LED Driver can be earthed via metal housing. If the LED Driver will be earthed, protection earth (PE) has to be used. There is no earth connection required for the functionality of the LED Driver. Earth connection is recommended to improve following behaviour.

- Electromagnetic interferences (EMI)
- Transmission of mains transients to the LED output

In general it is recommended to earth the LED Driver if the LED module is mounted on earthed luminaire parts respectively heat sinks and thereby representing a high capacity against earth.

For Class I application, protection earth need to connected with the metal housing (bottom part).

For Class II application, protection earth is no need to be connected, below 2 scenarios should be considered:

- If the LED Driver housing is screw on a metal part inside the luminaires, both LED Driver and LED module must be insulated.
- If the LED Driver housing is screw on a plastic part inside the luminaires, the LED module need to be insulated.

3.8 Current setting

250 mA: Terminal 0 and 2 connected with 0 Ω wire (max. 6 cm length) or resistor ADV Plug Type A BR (article number: 28001771)

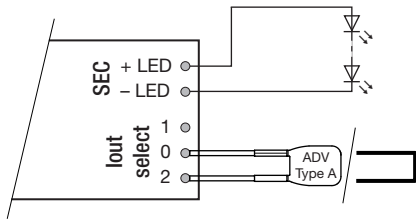

275 mA: Terminal 0 and 2 connected with resistor ADV Plug Type B BR (article number: 28001772)

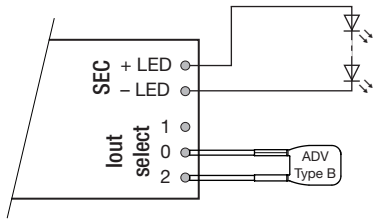

300 mA: Terminal 0 and 1 connected with 0 Ω wire (max. 6 cm length) or resistor ADV Plug Type A BR (article number: 28001771)

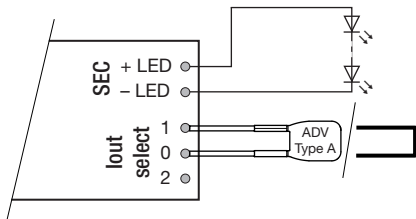

325 mA: Terminal 0 and 2 connected with resistor ADV Plug Type C BR (article number: 28001773)

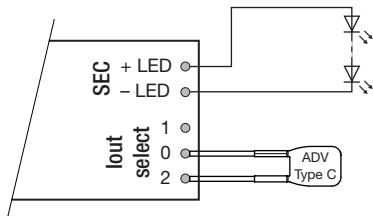

350 mA: All terminals open

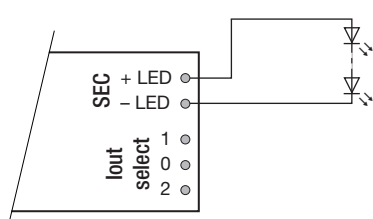

3.9 Mounting of device

Max. torque for fixing: 0.5 Nm/M4

4. Electrical values

Test at 230 V 50 Hz.

4.1 Efficiency vs load

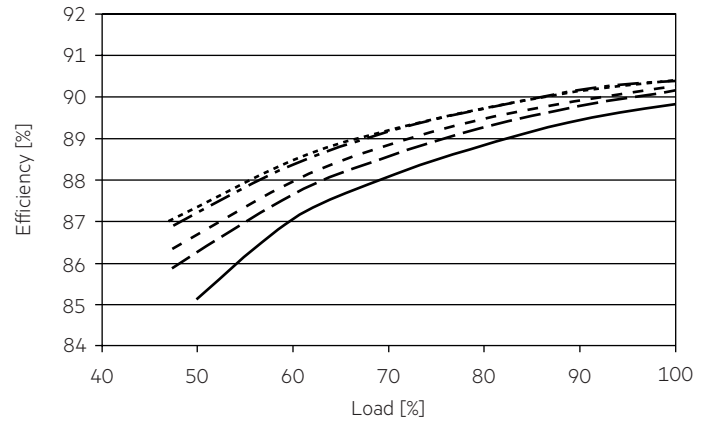

4.2 Power factor vs load

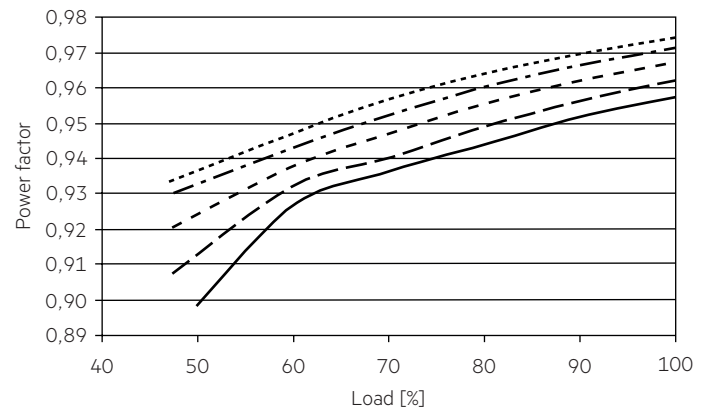

4.3 Input power vs load

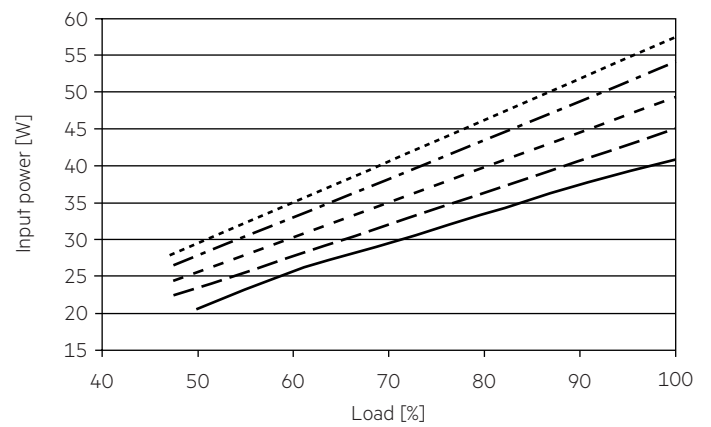

4.4 Input current vs load

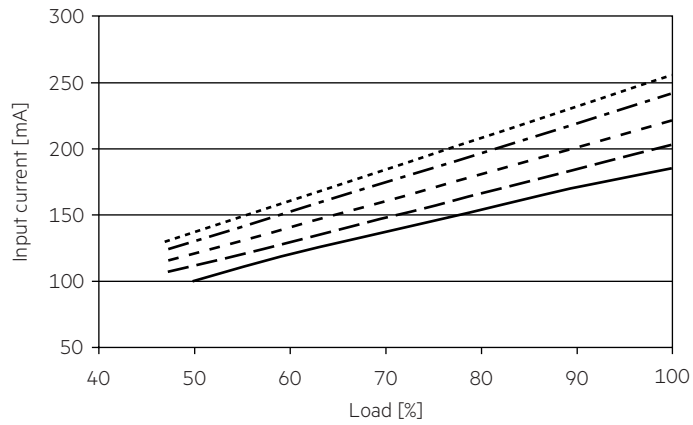

4.5 THD vs load

THD without harmonic < 5 mA (0.6 %) of the input current:

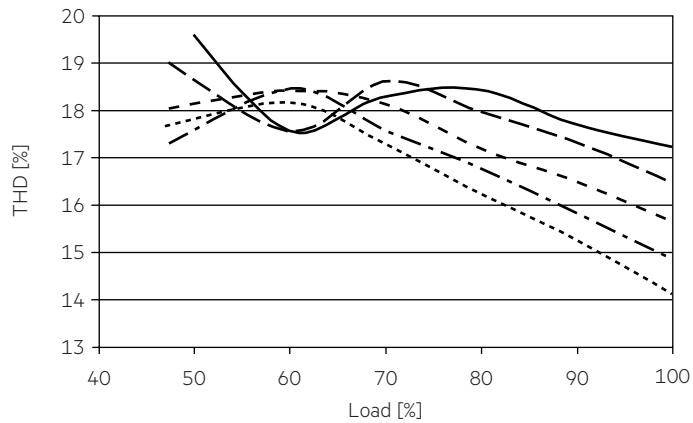

- 250 mA
- - - 275 mA
- - - 300 mA
- - - 325 mA
- · · 350 mA

4.6 Maximum loading of automatic circuit breakers in relation to inrush current

Automatic circuit breaker type	C10	C13	C16	C20	B10	B13	B16	B20	Inrush current
Installation Ø	1.5 mm ²	1.5 mm ²	1.5 mm ²	2.5 mm ²	1.5 mm ²	1.5 mm ²	1.5 mm ²	2.5 mm ²	<i>I</i> _{max} Time
LC 53W 250-350mA flexC Ip ADV	23	31	40	50	14	19	24	30	25 A 280 µs

This are max. values calculated out of inrush current! Please consider not to exceed the maximum rated continuous current of the circuit breaker. Calculation uses typical values from ABB series S200 as a reference. Actual values may differ due to used circuit breaker types and installation environment.

4.7 Harmonic distortion in the mains supply (at 230 V / 50 Hz and full load) in %

	THD	3.	5.	7.	9.	11.
LC 53W 250-350mA flexC Ip ADV	< 18	< 15	< 5	< 3	< 2	< 1

Acc. to 6100-3-2. Harmonics < 5 mA or < 0.6 % (whatever is greater) of the input current are not considered for calculation of THD.

5. Functions

5.1 Short-circuit behaviour

In case of a short circuit on the output side (LED) the LED Driver switches into hic-cup mode. After elimination of the short-circuit fault the LED Driver will recover automatically.

5.2 No-load operation

The LED Driver works in burst working mode to provide a constant output voltage regulation which allows the application to be able to work safely when LED string opens due to a failure.

5.3 Overload protection

If the maximum load is exceeded by a defined internal limit, the LED Driver will protect itself and LED may flicker. After elimination of the overload, the nominal operation is restored automatically.

5.4 DC emergency operation

The LED Driver is designed to operate on DC voltage and pulsed DC voltage. For a reliable operation, make sure that also in DC emergency operation the LED Driver is run within the specified conditions.

Light output level in DC operation (EOF_i): 100 % (cannot be adjusted)

The voltage-dependent input current of Driver incl. LED module is depending on the used load.

The nominal voltage-dependent no-load current of Driver (without or defect LED module) is for:

AC: < 35 mA

DC: < 5 mA

6. Miscellaneous

6.1 Insulation and electric strength testing of luminaires

Electronic devices can be damaged by high voltage. This has to be considered during the routine testing of the luminaires in production.

According to IEC 60598-1 Annex Q (informative only!) or ENEC 303-Annex A, each luminaire should be submitted to an insulation test with 500 V_{DC} for 1 second. This test voltage should be connected between the interconnected phase and neutral terminals and the earth terminal. The insulation resistance must be at least 2 MΩ.

As an alternative, IEC 60598-1 Annex Q describes a test of the electrical strength with 1500 V_{AC} (or 1.414 x 1500 V_{DC}). To avoid damage to the electronic devices this test must not be conducted.

6.2 Conditions of use and storage

Humidity: 5 % up to max. 85 %,
not condensed
(max. 56 days/year at 85 %)

Storage temperature: -40 °C up to max. +80 °C

The devices have to be within the specified temperature range (t_a) before they can be operated.

The LED Driver is declared as inbuilt LED controlgear, meaning it is intended to be used within a luminaire enclosure.

If the product is used outside a luminaire, the installation must provide suitable protection for people and environment (e.g. in illuminated ceilings).

6.3 Maximum number of switching cycles

All LED Driver are tested with 50,000 switching cycles.

6.4 Additional information

Additional technical information at www.tridonic.com → Technical Data

Lifetime declarations are informative and represent no warranty claim. No warranty if device was opened.

X-ON Electronics

Largest Supplier of Electrical and Electronic Components

Click to view similar products for [LED Power Supplies](#) category:

Click to view products by [Tridonic](#) manufacturer:

Other Similar products are found below :

[ESS015W-1000-12](#) [PDA-WIFI](#) [PIFC-K250F](#) [PITB-K222A](#) [ALD-514012PJ134](#) [LB240S24KH](#) [LMH020-SPLC-0000-0000001](#) [79534](#) [79535](#)
[EUG-200S210DT](#) [ESS030W-1050-21](#) [ESS030W-0900-32](#) [BPOXL 4-12-035](#) [ESS010W-0350-24](#) [ESM060W-1400-42](#) [PDA080B-1A0G](#)
[PDA150B-S1A5G](#) [SLM140W-1.05-130-ZA](#) [ESS015W-0700-18](#) [EUD-150S350DVA](#) [LWA320-C420-ARK-B](#) [HVG-240-48AB](#) [HVG-320-36AB](#) [HVG-320-54AB](#) [ELG-240-C1400AB](#) [EUK-150S105DV](#) [BXCS-12Z-N2P-B1-A](#) [BXPR-WN-01-A](#) [BXCS-12D-N2P-01-A](#) [BXCS-12W-N2P-01-A](#) [LC 50W 200-350ML 170V FLEXC LP SNC4](#) [LC 25W 200-350ML 70V FLEXC LP SNC4](#) [LC 35W 200-350ML 121V FLEXC LP SNC4](#) [LC 10W 250MA FIXC SC SNC2](#) [LC 35W 800MA FIXC SR ADV2](#) [LC 38W 900MA FIXC SR ADV2](#) [LC 34W 800MA FIXC SC ADV2](#) [LC 44W 1050MA FIXC SC ADV2](#) [LC 38W 900MA 42V FIXC SRL ADV2](#) [HVG-320-48AB](#) [CNB50W-1200-42-CAS](#) [CNB30W-0600-42-CAS](#) [LCI 100W 1400MA TEC C](#) [LCI 100W 2100MA TEC C](#) [LCI 150W 1750MA TEC C](#) [LCI 150W 2100MA TEC C](#) [87500284](#) [87500447](#) [LC 50W 1200MA FIXC SR SNC](#) [87500554](#)