

**Driver LC 60W 24V Ip SNC2**

essence series 24 V – not dimmable (IP20)

**Product description**

- \_ Constant voltage LED driver
- \_ Output voltage 24 V
- \_ Max. output power 60 W
- \_ For luminaires of protection class I and protection class II
- \_ Dimmable via external PWM LED dimmers attached on output side
- \_ Power input on stand-by < 0.5 W
- \_ Nominal lifetime up to 100,000 h
- \_ 5 years guarantee (conditions at <https://www.tridonic.com/manufacturer-guarantee-conditions>)

**Typical applications**

- \_ Cove lighting, facade accent lighting, ceiling integration

**Technical details**

- \_ 24 V, 60 W
- \_ Output LF voltage ripple (< 120 Hz)  $\pm 1.5\%$
- \_ Small cross section
- \_ Push terminals for simple wiring

**System solution**

- \_ Tridonic LLE-FLEX ADV G2 600, 1,200, 1,800 lm/m
- \_ Tridonic LLE-FLEX EXC 600, 1,200, 1,800, 2,500 lm/m
- \_ In connection with Flex accessories wire to PCB plug

**Website**

<http://www.tridonic.com/87501092>



Spotlights



Downlights



Linear



Area



Floor | Wall



Free-standing



Street



Decorative



High bay

**Driver LC 60W 24V Ip SNC2**

essence series 24 V – not dimmable (IP20)

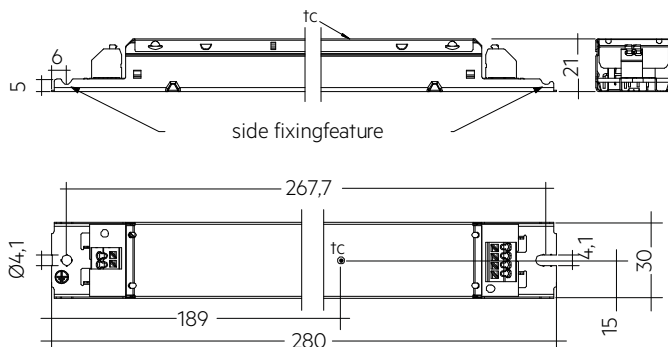
**Ordering data**

Type	Article number	Packaging, carton	Packaging, pallet	Packaging, high volume	Weight per pc.
LC 60W 24V Ip SNC2	87501092	50 pc(s).	700 pc(s).	2,100 pc(s).	0.21 kg

**Technical data**

Rated supply voltage	220 – 240 V
AC voltage range	198 – 264 V
Mains frequency	50 / 60 Hz
Overvoltage protection	320 V AC, 48 h
Typ. rated current (at 230 V, 50 Hz, full load) <sup>①</sup>	300 mA
Leakage current (at 230 V, 50 Hz, full load) <sup>①</sup>	< 500 µA
Max. input power	66 W
Typ. efficiency (at 230 V, 50 Hz, full load)	90 %
λ over full operating range (max.) <sup>①</sup>	0.99
λ over full operating range (min.)	0.85C
Typ. input current in no-load operation	19.5 mA
Typ. input power in no-load operation	0.44 W
In-rush current (peak / duration)	34.6 A / 210 µs
THD (at 230 V, 50 Hz, full load) <sup>①</sup>	< 10 %
Output P_ST_LM (at full load)	≤ 1
Output SVM (at full load)	≤ 0.4
Starting time (at 230 V, 50 Hz, full load) <sup>①</sup>	< 0.5 s
Turn off time (at 230 V, 50 Hz, full load)	< 0.5 s
Hold on time at power failure (output)	0 s
Output voltage tolerance	± 1 V
Output LF voltage ripple (< 120 Hz)	± 1.5 %
Max. output voltage (U-OUT)	26 V
Burst capability	1 kV
Mains surge capability (between L - N)	1 kV
Mains surge capability (between L/N - PE)	2.4 kV
Type of protection	IP20
Lifetime	up to 100,000 h
Guarantee (conditions at www.tridonic.com)	5 Year(s)
Dimensions L x W x H	280 x 30 x 21 mm

**Approval marks****Standards**

EN 55015, EN 61000-3-2, EN 61000-3-3, EN 61347-1, EN 61347-2-13, EN 62384, EN 61547

## Specific technical data

Type	Load	Output voltage	Output current	Max. Ausgangsleistung	Typ. power consumption	Typ. current consumption	tc point max.	Ambient temperature ta
LC 60W 24V Ip SNC2	30 %	24 V	750 mA	18 W	21.4 W	103 mA	65 °C	-20 ... +50 °C
LC 60W 24V Ip SNC2	40 %	24 V	1,000 mA	24 W	27.6 W	129 mA	65 °C	-20 ... +50 °C
LC 60W 24V Ip SNC2	50 %	24 V	1,250 mA	30 W	33.8 W	155 mA	65 °C	-20 ... +50 °C
LC 60W 24V Ip SNC2	60 %	24 V	1,500 mA	36 W	40.1 W	181 mA	65 °C	-20 ... +50 °C
LC 60W 24V Ip SNC2	70 %	24 V	1,750 mA	42 W	46.4 W	208 mA	65 °C	-20 ... +50 °C
LC 60W 24V Ip SNC2	80 %	24 V	2,000 mA	48 W	52.7 W	235 mA	70 °C	-20 ... +50 °C
LC 60W 24V Ip SNC2	90 %	24 V	2,250 mA	54 W	59.1 W	262 mA	70 °C	-20 ... +50 °C
LC 60W 24V Ip SNC2	100 %	24 V	2,500 mA	60 W	65.5 W	289 mA	70 °C	-20 ... +50 °C

① Valid at 100 % dimming level.

## 1. Standards

EN 55015  
 EN 61000-3-2  
 EN 61000-3-3  
 EN 61347-1  
 EN 61347-2-13  
 EN 62384  
 EN 61547

## 2. Thermal details and lifetime

### 2.1 Expected lifetime

Expected lifetime					
Type	Output load	ta	40 °C	45 °C	50 °C
	> 18 – 30 W	tc	55 °C	60 °C	65 °C
		Lifetime	>100,000 h	>100,000 h	>100,000 h
LC 60W 24V Ip SNC2	> 30 – 42 W	tc	55 °C	60 °C	65 °C
		Lifetime	>100,000 h	>100,000 h	83,000 h
	> 42 – 60 W	tc	60 °C	65 °C	70 °C
		Lifetime	89,000 h	67,000 h	50,000 h

The LED control gear is designed for a lifetime stated above under reference conditions and with a failure probability of less than 10 %.

The relation of tc to ta temperature depends also on the luminaire design.

If the measured tc temperature is approx. 5 K below tc max., ta temperature should be checked and eventually critical components (e.g. ELCAP) measured. Detailed information on request.

## 3. Installation / wiring

### 3.1 Circuit diagram

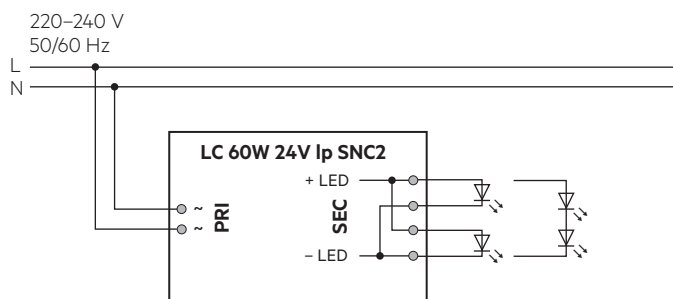

### 3.2 Wiring type and cross section

For wiring use stranded wire with ferrules or solid wire from 0.5 – 1.5 mm<sup>2</sup>. Strip 8.5 – 9.5 mm of insulation from the cables to ensure perfect operation of the push-wire terminals.

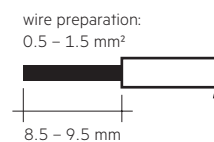

### 3.3 Release of the wiring

Press down the “push button” and remove the cable from front.

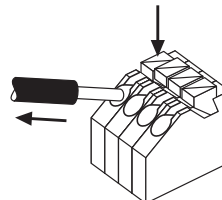

### 3.4 Wiring guidelines

- The cables should be run separately from the mains connections and mains cables to ensure good EMC conditions.
- The LED wiring should be kept as short as possible to ensure good EMC. The max. secondary cable length is 2 m (4 m circuit).
- The LED driver has no inverse-polarity protection on the secondary side. Wrong polarity can damage LED modules with no inverse-polarity protection.
- Wrong wiring of the LED driver can lead to malfunction or irreparable damage.
- To avoid the damage of the Driver, the wiring must be protected against short circuits to earth (sharp edged metal parts, metal cable clips, louver, etc.).

### 3.5 Earth connection

The earth connection is conducted as protection earth (PE). The LED driver can be earthed via metal housing. If the LED driver will be earthed, protection earth (PE) has to be used. There is no earth connection required for the functionality of the LED driver. Earth connection is recommended to improve following behaviour:

- Electromagnetic interferences (EMI)
- LED glowing at standby
- Transmission of mains transients to the LED output

In general it is recommended to earth the LED driver if the LED module is mounted on earthed luminaire parts respectively heat sinks and thereby representing a high capacity against earth.

### 3.6 Installation instructions

The LED module and all contact points within the wiring must be sufficiently insulated against 3 kV surge voltage. Air and creepage distance must be maintained.

## 4. Electrical values

### 4.1 Efficiency vs. load

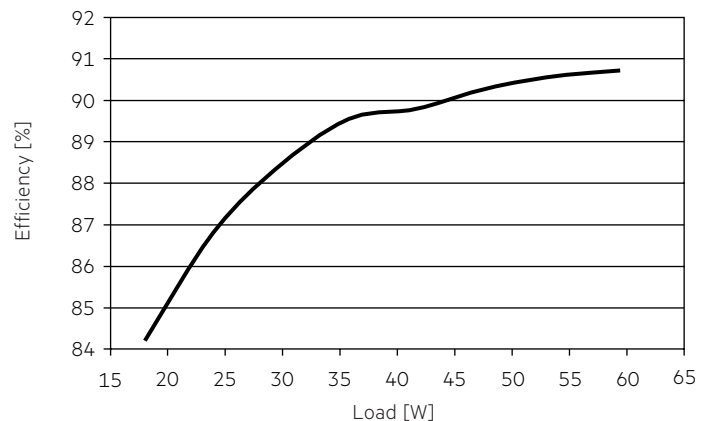

### 4.2 Power factor vs. Load

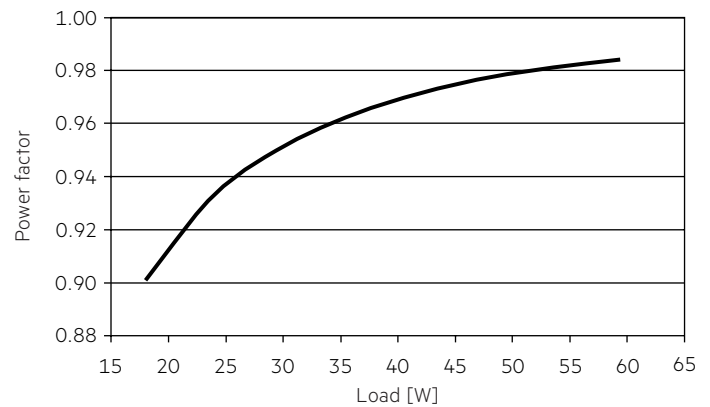

### 4.3 THD vs. Load

THD without harmonic < 5 mA (0.6 %) of the input current:

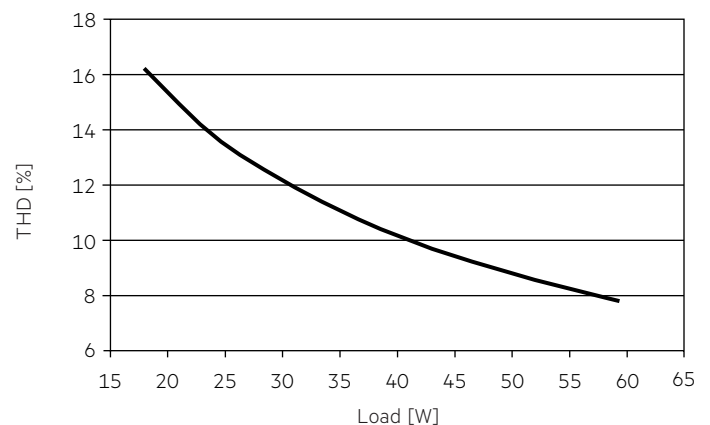

#### 4.4 Maximum loading of automatic circuit breakers in relation to inrush current

Automatic circuit breaker type	C10	C13	C16	C20	B10	B13	B16	B20	Inrush current	
Installation Ø	1.5 mm <sup>2</sup>	1.5 mm <sup>2</sup>	2.5 mm <sup>2</sup>	2.5 mm <sup>2</sup>	1.5 mm <sup>2</sup>	1.5 mm <sup>2</sup>	2.5 mm <sup>2</sup>	2.5 mm <sup>2</sup>	$I_{max}$	time
<b>LC 60W 24V Ip SNC2</b>	22	28	35	43	13	17	21	26	34.6 A	210 µs

These are max. values calculated out of inrush current! Please consider not to exceed the maximum rated continuous current of the circuit breaker.

Calculation uses typical values from ABB series S200 as a reference.

Actual values may differ due to used circuit breaker types and installation environment.

#### 4.5 Harmonic distortion in the mains supply (at 230 V / 50 Hz and full load) in %

	THD	3.	5.	7.	9.	11.
<b>LC 60W 24V Ip SNC2</b>	< 10	< 10	< 5	< 2	< 2	< 2

Acc. to 61000-3-2. Harmonics < 5 mA or < 0.6 % (whatever is greater) of the input current are not considered for calculation of THD.

## 5. Functions

### 5.1 Overload protection

If the maximum load is exceeded by a defined internal limit, the LED will flicker, and output voltage will be reduced. When fault is removed, the driver can go back to work automatically without resetting input main power.

### 5.2 Overtemperature protection

The LED driver is protected against temporary thermal overheating. If the temperature limit is exceeded the LED will turn to dark, if the temperature continues to increase, it will flicker and restart automatically after the driver has cooled down. The temperature protection is activated approx. + 15 °C above  $T_c$  max.

### 5.3 Short-circuit behaviour

In case of a short circuit at the LED output the LED output is switched off. When fault is removed, the driver can go back to work automatically without resetting input main power.

### 5.4 No-load operation

The LED driver will not be damaged in the no-load operation. When the output is floating and doesn't connect the LED modules, the output voltage will keep the max. voltage (< 26 V). After connecting the LED load, the driver works normally without resetting the main power.

### 5.5 Hot plug-in

Hot plug-in is supported.

### 5.6 Use of PWM dimmers

PWM dimmers can be used to dim the attached LED module.

## 7. Miscellaneous

### 7.1 Insulation and electric strength testing of luminaires

Electronic devices can be damaged by high voltage. This has to be considered during the routine testing of the luminaires in production.

According to IEC 60598-1 Annex Q (informative only!) or ENEC 303-Annex A, each luminaire should be submitted to an insulation test with 500 V<sub>DC</sub> for 1 second. This test voltage should be connected between the interconnected phase and neutral terminals and the earth terminal. The insulation resistance must be at least 2 MΩ.

As an alternative, IEC 60598-1 Annex Q describes a test of the electrical strength with 1500 V<sub>AC</sub> (or 1.414 × 1500 V<sub>DC</sub>). To avoid damage to the electronic devices this test must not be conducted.

### 7.2 Conditions of use and storage

Humidity: 5 % up to max. 85 %, not condensed (max. 56 days/year at 85 %)

Storage temperature: -40 °C up to max. +80 °C

The devices have to be acclimatised to the specified temperature range ( $t_a$ ) before they can be operated.

The LED driver is declared as inbuilt LED controlgear, meaning it is intended to be used within a luminaire enclosure. If the product is used outside a luminaire, the installation must provide suitable protection for people and environment (e.g. in illuminated ceilings).

### 7.3 Maximum number of switching cycles

All LED driver are tested with 50,000 switching cycles.

### 7.4 Additional information

Additional technical information at [www.tridonic.com](http://www.tridonic.com) → Technical Data

Lifetime declarations are informative and represent no warranty claim. No warranty if device was opened.

## X-ON Electronics

Largest Supplier of Electrical and Electronic Components

*Click to view similar products for [LED Power Supplies](#) category:*

*Click to view products by [Tridonic](#) manufacturer:*

Other Similar products are found below :

[PIFC-K250F](#) [PITB-K222A](#) [AC-A60VD24H2.5](#) [ALD-514012PJ134](#) [PWD-60-1-70-P](#) [EUG-200S210DT](#) [ESS030W-1050-21](#) [BPOXL 4-12-035](#) [ESS010W-0180-42](#) [ESS010W-0350-24](#) [ESS010W-0200-42](#) [SLM140W-1.05-130-ZA](#) [ESS015W-0700-18](#) [HVG-240-48AB](#) [HVG-240-54AB](#) [OTE 25/220-240/700 PC](#) [DAL30W-0600-42-T](#) [HVG-320-48AB](#) [CNB30W-0600-42-CAS](#) [87500757](#) [I-SELECT 2 PLUG 2100MA BL](#) [LCU 48V 75W DC-STR FO](#) [LC 45 W 500-1400 MA FLEXC SC EXC](#) [I-SELECT 2 PLUG 2000MA BL](#) [LC 50/200-350/170 FLEXCC LP](#) [SNC3](#) [LCO 14/100-500/38 O4A NF C EXC3](#) [LC 28W 300-700MA 42 FLEXC NF SC EXC3](#) [LC 44/1050/42 FIXC SRL ADV2](#) [LCA 60W 900-1750MA ONE4ALL C PRE](#) [LC 8/180/44 FIXC SR SNC2](#) [LC 19/200-350/54 FLEXC LP SNC4](#) [BXDR-PS-75BS-E116D-01-A](#) [LC 30/500/54 FIXC SR SNC2](#) [LCA 60W 24V ONE4ALL SC PRE SP](#) [LC 60W 75-330MA 310V FLEXC NF H16 EXC4](#) [LC 8/180/42 FIXC PC SR SNC2](#) [LC 10/350/29 FIXC SR SNC2](#) [LC 25/500/43 FIXC SR SNC2](#) [LC 50/100-400/140 PO4A NF H16 PRE3](#) [LC 25/600/42 FIXC SRL ADV2](#) [LCO 24/200-1050/39 NF C ADV3](#) [ELEMENT 35/220...240/900 G3](#) [LC 25W 350-1050MA FLEXC SR EXC](#) [LC 60/700/86 FIXC SR SNC2](#) [LC 35W 24 ONE4ALL IP PRE](#) [BXDR-PS-25BS-E107D-01-A](#) [LC 17W 250-700MA FLEXC SR EXC](#) [LC 15W 350MA FIXC C SNC](#) [LC 14W 700MA FIXC PC SR SNC2](#) [LC 200W 24V SC SNC](#)