

### Driver LC 50/60W 1200/700/1400mA fixC C SNC

essence series

#### Product description

- Fixed output built-in LED Driver
- Constant current LED Driver
- For luminaires of protection class I and protection class II
- Temperature protection as per EN 61347-2-13 C5e
- KC certificate for LC 60W 1400mA fixC C SNC
- Output current 1,200, 700 or 1,400 mA
- Max. output power 50 or 60 W
- Nominal life-time up to 50,000 h
- 5-year guarantee

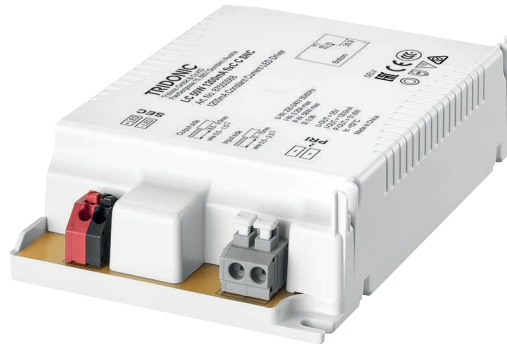

#### Housing properties

- Casing: polycarbonat, white
- Type of protection IP20

#### Functions

- Overtemperature protection
- Overload protection
- Short-circuit protection
- No-load protection



**Standards**, page 3

**Wiring diagrams and installation examples**, page 4



IP20 SELV RoHS

### Driver LC 50/60W 1200/700/1400mA fixC C SNC

essence series

#### Technical data

Rated supply voltage	220 – 240 V
AC voltage range	198 – 264 V
Mains frequency	50 / 60 Hz
Overvoltage protection	320 V AC, 1 h
THD (at 230 V, 50 Hz, full load)	< 20 %
Output current tolerance <sup>®</sup>	± 7.5 %
Typ. current ripple (at 230 V, 50 Hz, full load)	± 30 %
Starting time (at 230 V, 50 Hz, full load)	≤ 0.5 s
Turn off time (at 230 V, 50 Hz, full load)	≤ 0.2 s
Hold on time at power failure (output)	0 s
Ambient temperature ta	-20 ... +50 °C
Ambient temperature ta (at life-time 50,000 h)	40 °C
Storage temperature ts	-40 ... +80 °C
Life-time	up to 50,000 h
Dimensions L x W x H	123 x 75 x 29.7 mm

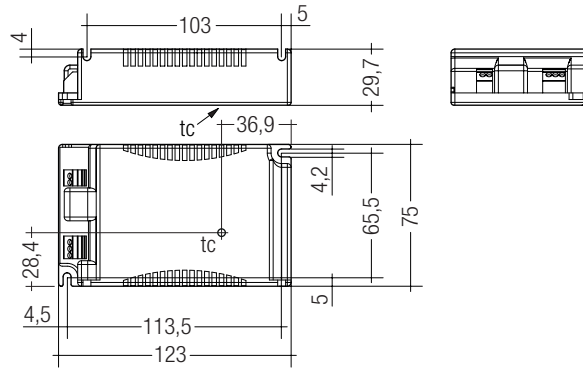

#### Ordering data

Type <sup>®</sup>	Article number <sup>®</sup>	Packaging, carton	Packaging, low volume	Packaging, high volume	Weight per pc.
LC 50W 1200mA fixC C SNC	87500568	30 pc(s).	450 pc(s).	2,250 pc(s).	0.151 kg
LC 60W 700mA fixC C SNC	87500569	30 pc(s).	450 pc(s).	2,250 pc(s).	0.147 kg
LC 60W 1400mA fixC C SNC	87500570	30 pc(s).	450 pc(s).	2,250 pc(s).	0.156 kg

#### Specific technical data

Type	Output current <sup>®</sup>	Input current (at 230 V, 50 Hz, full load)	Max. input power	Typ. power consumption (at 230 V, 50 Hz, full load)	Output power range	$\lambda$ at full load <sup>®</sup>	Efficiency at full load <sup>®</sup>	$\lambda$ at min. load <sup>®</sup>	Efficiency at min. load <sup>®</sup>	Min. forward voltage	Max. forward voltage	Max. output voltage	Max. output peak current at full load <sup>®</sup>	Max. output peak current at min. load <sup>®</sup>	Max. casing temperature tc
LC 50W 1200mA fixC C SNC	1,200 mA	260 mA	58 W	55.5 W	36.0 – 51.6 W	0.96	90 %	0.92C	88 %	30 V	43 V	55 V	1,700 mA	1,800 mA	82 °C
LC 60W 700mA fixC C SNC	700 mA	290 mA	68 W	66.0 W	42.0 – 59.5 W	0.96	91 %	0.94C	89 %	60 V	85 V	100 V	1,000 mA	1,100 mA	85 °C
LC 60W 1400mA fixC C SNC	1,400 mA	300 mA	68 W	66.5 W	42.0 – 60.2 W	0.96	90 %	0.94C	88 %	30 V	43 V	55 V	2,000 mA	2,100 mA	88 °C

<sup>®</sup> Test result at 230 V, 50 Hz.

<sup>®</sup> The trend between min. and full load is linear.

<sup>®</sup> Output current is mean value.

<sup>®</sup> KC approval mark for art. no.: 87500568 and 87500570.

**Standards**

EN 55015  
EN 61000-3-2  
EN 61000-3-3  
EN 61347-1  
EN 61347-2-13  
EN 61547

**Overload protection**

If the output voltage range is exceeded the LED Driver will protect itself and LED may flicker. After elimination of the overload, the nominal operation is restored automatically.

**Overtemperature protection**

The LED Driver is protected against temporary thermal overheating. If the temperature limit is exceeded, the output current is reduced to limit  $t_c$  at a certain level.

The temperature protection is activated typically at 10 °C above  $t_c$  max.

**Short-circuit behaviour**

In case of a short circuit on the secondary side (LED) the LED Driver switches into hic-cup mode. After elimination of the short-circuit fault the LED Driver will recover automatically.

**No-load operation**

The LED Driver works in burst working mode to provide a constant output voltage regulation which allows the application to be able to work safely when LED string opens due to a failure.

**Expected life-time**

Type	$t_a$	40 °C	50 °C	60 °C
<b>LC 50W 1200mA fixC C SNC</b>	$t_c$	70 °C	82 °C	x
	Life-time	50,000 h	30,000 h	x
<b>LC 60W 700mA fixC C SNC</b>	$t_c$	75 °C	85 °C	x
	Life-time	50,000 h	30,000 h	x
<b>LC 60W 1400mA fixC C SNC</b>	$t_c$	75 °C	88 °C	x
	Life-time	50,000 h	30,000 h	x

The LED Drivers are designed for a life-time stated above under reference conditions and with a failure probability of less than 10 %.

Life-time declarations are informative and represent no warranty claim.

**Glow-wire test**

according to EN 61347-1 with increased temperature of 850 °C passed.

**Mounting of device**

Max. torque for fixing: 0.5 Nm/M4

**Conditions of use and storage**

Humidity: 5% up to max. 85 %, not condensed (max. 56 days/year at 85 %)

Storage temperature: -40 °C up to max. +80 °C

The devices have to be within the specified temperature range ( $t_a$ ) before they can be operated.

**Installation instructions**

The LED module and all contact points within the wiring must be sufficiently insulated against 3 kV surge voltage.

Air and creepage distance must be maintained.

**Replace LED module**

1. Mains off
2. Remove LED module
3. Wait for 10 seconds
4. Connect LED module again

Hot plug-in or secondary switching of LEDs is not permitted and may cause a very high current to the LEDs.

**Maximum loading of automatic circuit breakers in relation to inrush current**

Automatic circuit breaker type	C10	C13	C16	C20	B10	B13	B16	B20	Inrush current	
Installation $\emptyset$	1.5 mm <sup>2</sup>	1.5 mm <sup>2</sup>	1.5 mm <sup>2</sup>	2.5 mm <sup>2</sup>	1.5 mm <sup>2</sup>	1.5 mm <sup>2</sup>	1.5 mm <sup>2</sup>	2.5 mm <sup>2</sup>	$I_{max}$	Time
<b>LC 50W 1200mA fixC C SNC</b>	35	45	60	80	35	45	60	80	10 A	50 $\mu$ s
<b>LC 60W 700mA fixC C SNC</b>	25	35	45	55	25	35	45	55	12 A	50 $\mu$ s
<b>LC 60W 1400mA fixC C SNC</b>	25	35	45	55	25	35	45	55	12 A	50 $\mu$ s

These are max. values calculated out of continuous current running the device on full load.

There is no limitation due to inrush current.

If load is smaller than full load for calculation only continuous current has to be considered.

**Harmonic distortion in the mains supply (at 230 V / 50 Hz and full load) in %**

	THD	3.	5.	7.	9.	11.
<b>LC 50W 1200mA fixC C SNC</b>	< 20	< 12	< 4	< 2	< 2	< 2
<b>LC 60W 700mA fixC C SNC</b>	< 20	< 12	< 4	< 2	< 2	< 2
<b>LC 60W 1400mA fixC C SNC</b>	< 20	< 12	< 4	< 2	< 2	< 2

### Wiring diagram

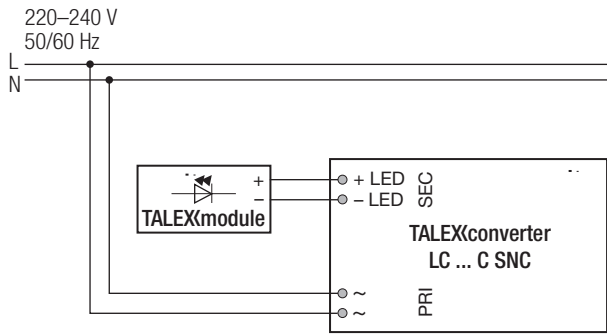

### Insulation and electric strength testing of luminaires

Electronic devices can be damaged by high voltage. This has to be considered during the routine testing of the luminaires in production.

According to IEC 60598-1 Annex Q (informative only!) or ENEC 303-Annex A, each luminaire should be submitted to an insulation test with 500 V<sub>DC</sub> for 1 second. This test voltage should be connected between the interconnected phase and neutral terminals and the earth terminal. The insulation resistance must be at least 2 MΩ.

As an alternative, IEC 60598-1 Annex Q describes a test of the electrical strength with 1500 V<sub>AC</sub> (or 1.414 x 1500 V<sub>DC</sub>). To avoid damage to the electronic devices this test must not be conducted.

### Maximum number of switching cycles

All LED Driver are tested with 50,000 switching cycles. The actually achieved number of switching cycles is significantly higher.

### Additional information

Additional technical information at [www.tridonic.com](http://www.tridonic.com) → Technical Data

Guarantee conditions at [www.tridonic.com](http://www.tridonic.com) → Services

Life-time declarations are informative and represent no warranty claim. No warranty if device was opened.

### Wiring type and cross section

The input wiring can be stranded wires with ferrules with a cross section of 0.5 – 1.5 mm<sup>2</sup> or with solid wires with a cross section of 0.5 – 2.5 mm<sup>2</sup>. Strip 9 – 10 mm of insulation from the cables to ensure perfect operation of the push-wire terminals.

The output wiring can be done with a cross section of 0.5 – 1.5 mm<sup>2</sup>. Strip 8.5 – 9.5 mm of insulation from the cables to ensure perfect operation of the push-wire terminals.

#### Input wiring

wire preparation:  
Solid: 0.5 – 2.5 mm<sup>2</sup>  
Fine-stranded: 0.5 – 1.5 mm<sup>2</sup>

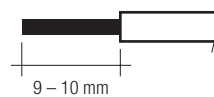

#### Output wiring

wire preparation:

0.5 – 1.5 mm<sup>2</sup>

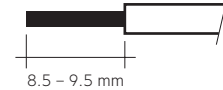

### Wiring guidelines

- All connections must be kept as short as possible to ensure good EMI behaviour.
- Mains leads should be kept apart from LED Driver and other leads (ideally 5 – 10 cm distance)
- Max. length of output wires is 2 m.
- Secondary switching is not permitted.
- Incorrect wiring can damage LED modules.
- To avoid the damage of the Driver, the wiring must be protected against short circuits to earth (sharp edged metal parts, metal cable clips, louver, etc.).

### Release of the wiring

Press down the “push button” and remove the cable from front.

#### Input terminal

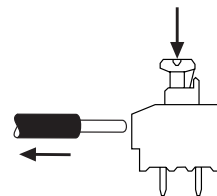

#### Output terminal

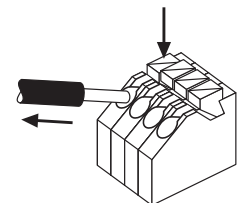

**Diagrams LC 50W 1200mA fixC C SNC**

Efficiency vs load

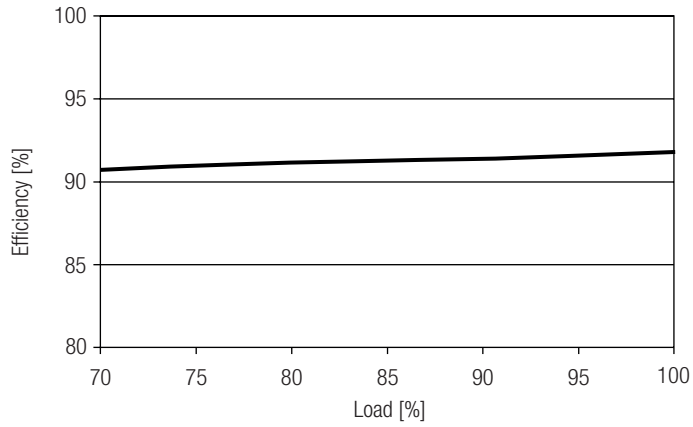

Power factor vs load

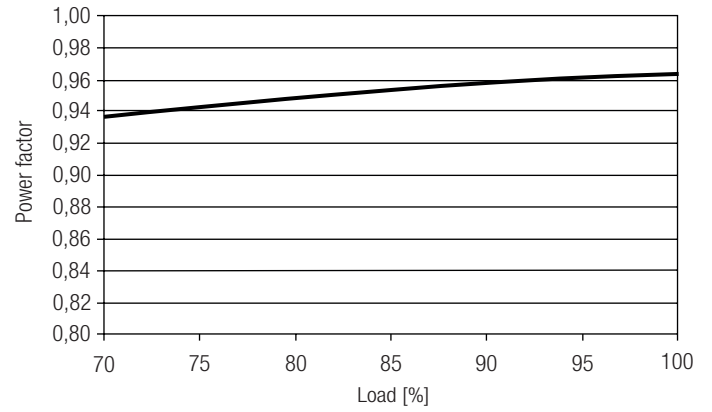

Input power vs load

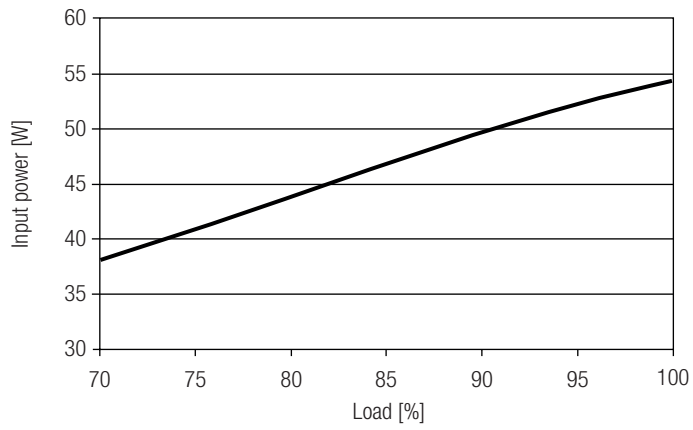

Input current vs load

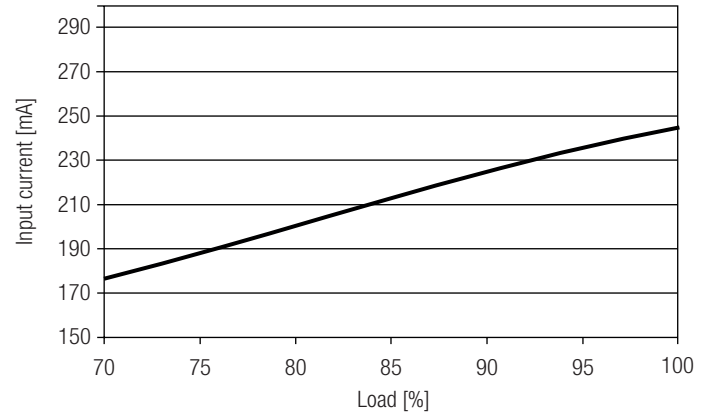

THD vs load

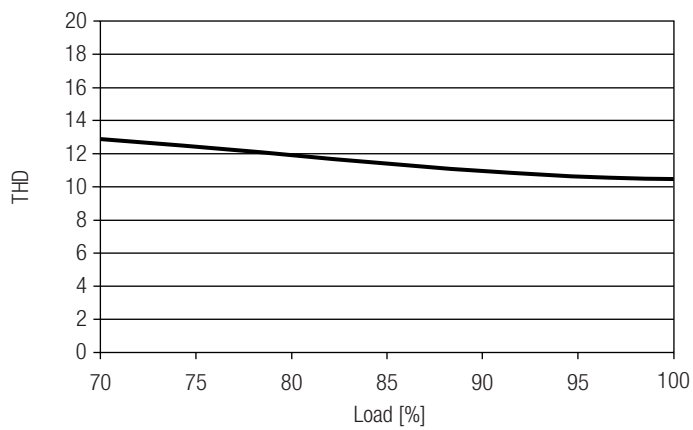

**Diagrams LC 60W 700mA fixC C SNC**

Efficiency vs load

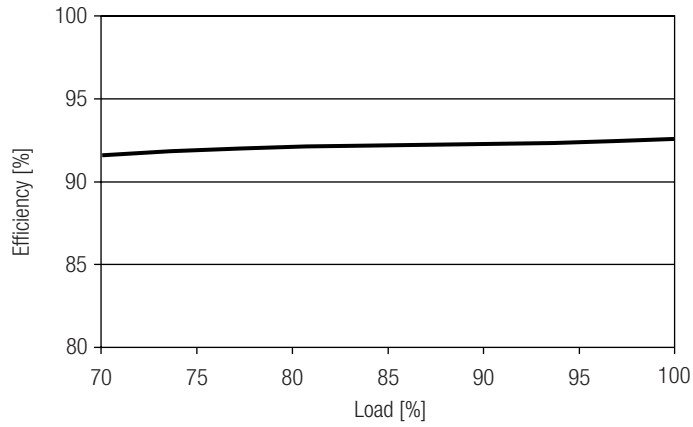

Power factor vs load

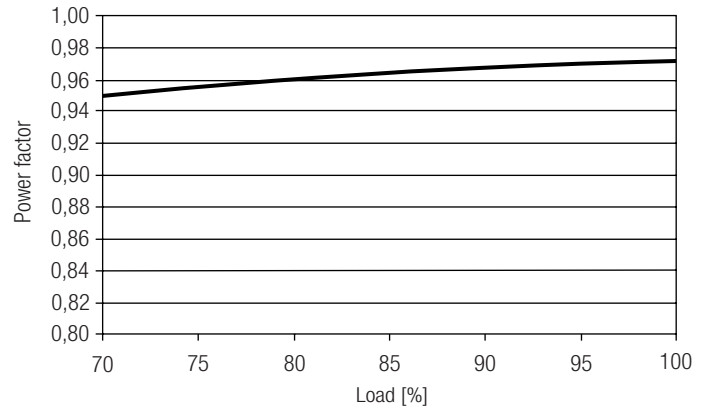

Input power vs load

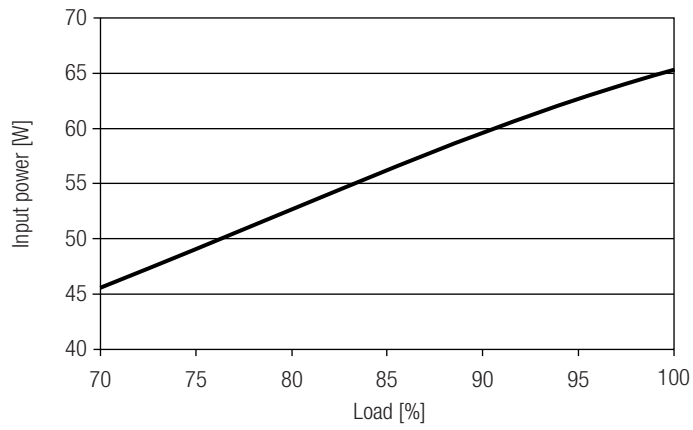

Input current vs load

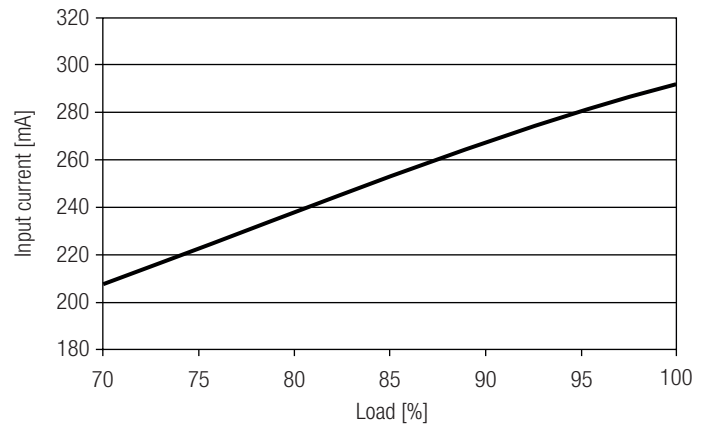

THD vs load

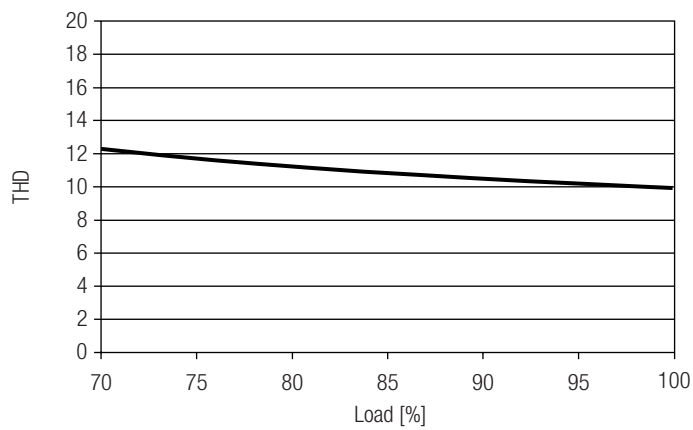

**Diagrams LC 60W 1400mA fixC C SNC**

Efficiency vs load

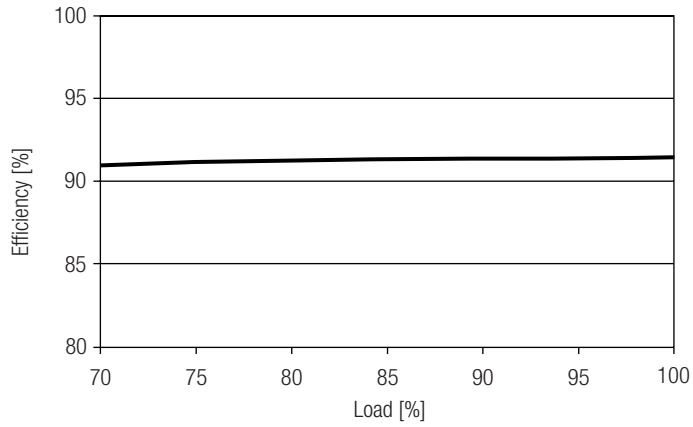

Power factor vs load

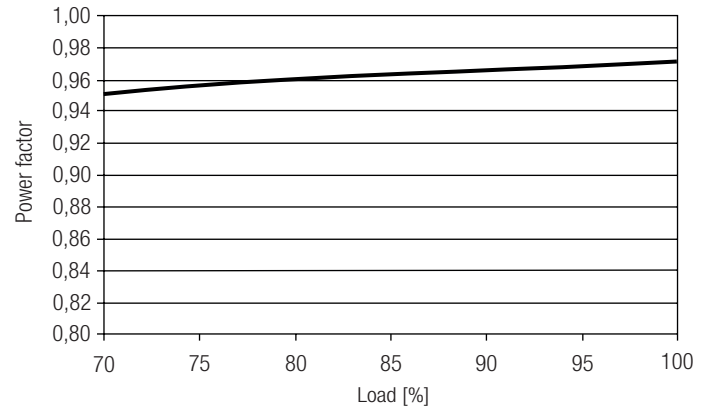

Input power vs load

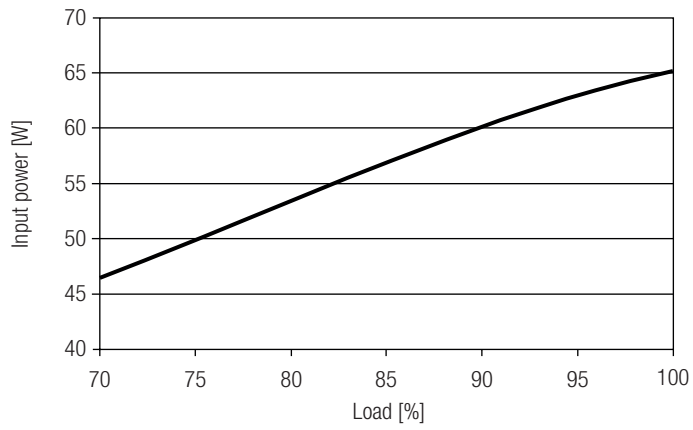

Input current vs load

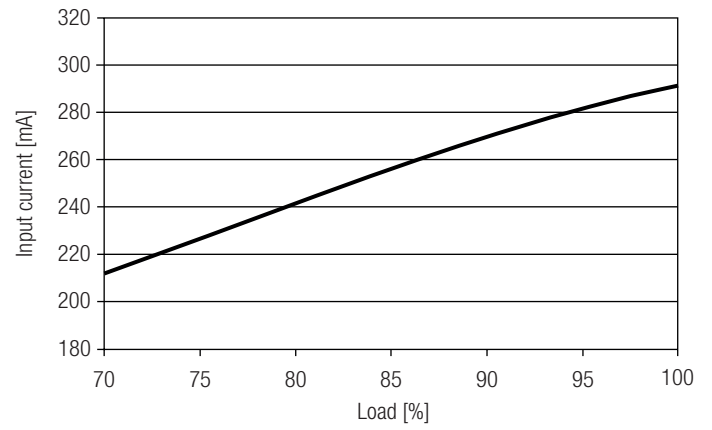

THD vs load

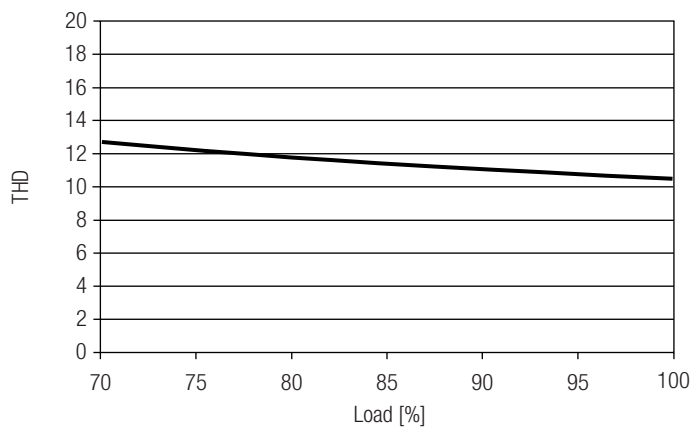

## X-ON Electronics

Largest Supplier of Electrical and Electronic Components

*Click to view similar products for [LED Power Supplies](#) category:*

*Click to view products by [Tridonic](#) manufacturer:*

Other Similar products are found below :

[PIFC-K250F](#) [PITB-K222A](#) [AC-A60VD24H2.5](#) [ALD-514012PJ134](#) [PWD-60-1-70-P](#) [ESS030W-1050-21](#) [BPOXL 4-12-035](#) [ESS010W-0180-42](#) [ESS010W-0350-24](#) [ESS010W-0200-42](#) [ESM060W-1400-42](#) [ESS010W-0500-12](#) [SLM140W-1.05-130-ZA](#) [ESS015W-0700-18](#) [HVG-240-54AB](#) [OTE 25/220-240/700 PC](#) [OT FIT 30/220-240/700 CS](#) [DAL30W-0600-42-T](#) [HVG-320-48AB](#) [CNB30W-0600-42-CAS](#) [87500757](#) [I-SELECT 2 PLUG 2100MA BL](#) [LCU 48V 75W DC-STR FO](#) [LC 45 W 500-1400 MA FLEXC SC EXC](#) [I-SELECT 2 PLUG 2000MA BL](#) [LC 50/200-350/170 FLEXCC LP SNC3](#) [LCO 14/100-500/38 O4A NF C EXC3](#) [LC 28W 300-700MA 42 FLEXC NF SC EXC3](#) [LC 44/1050/42 FIXC SRL ADV2](#) [LCA 60W 900-1750MA ONE4ALL C PRE](#) [LC 8/180/44 FIXC SR SNC2](#) [LC 19/200-350/54 FLEXC LP SNC4](#) [BXDR-PS-75BS-E116D-01-A](#) [LC 30/500/54 FIXC SR SNC2](#) [LCA 60W 24V ONE4ALL SC PRE SP](#) [LC 60W 75-330MA 310V FLEXC NF H16 EXC4](#) [LC 8/180/42 FIXC PC SR SNC2](#) [LC 10/350/29 FIXC SR SNC2](#) [LC 25/500/43 FIXC SR SNC2](#) [LC 50/100-400/140 PO4A NF H16 PRE3](#) [LC 25/600/42 FIXC SRL ADV2](#) [LCO 24/200-1050/39 NF C ADV3](#) [ELEMENT 35/220...240/900 G3](#) [LC 25W 350-1050MA FLEXC SR EXC](#) [LC 35W 24 ONE4ALL IP PRE](#) [BXDR-PS-25BS-E107D-01-A](#) [LC 17W 250-700MA FLEXC SR EXC](#) [LC 15W 350MA FIXC C SNC](#) [LC 14W 700MA FIXC PC SR SNC2](#) [LC 200W 24V SC SNC](#)