



Driver LCA 50W 350–1050mA one4all Ip PRE premium series SELV

Product description

- NEW: lumDATA (DALI-2 part ext. 251, 252 and 253)
- Dimmable built-in constant current LED Driver
- Dimming range 1 – 100 %
- For luminaires of protection class I and protection class II
- Adjustable output current between 350 and 1,050 mA
- Max. output power 50 W
- Up to 91 % efficiency
- Power input on stand-by < 0.15 W
- Nominal life-time up to 100,000 h
- 5-year guarantee

Housing properties

- Low profile metal casing with white cover
- Type of protection IP20

Interfaces

- one4all (DALI-2 DT 6, DSI, switchDIM, corridorFUNCTION)
- ready2mains™ (configuration and dimming via mains)
- Terminal blocks: 0° push terminals

Functions

- Adjustable output current in 1-mA-steps (DALI, ready2mains™) or with resistor plug (I-SELECT 2)
- Fulfills DALI-2 parts: 251 (Luminaire data), 252 (Energy reporting) and 253 (Diagnostics & Maintenance)
- Constant light output function (CLO)
- Power-up fading at AC
- Configurable via ready2mains™
- Switch off the Driver with fade2zero
- Protective features (overtemperature, short-circuit, overload, no-load, input voltage range, reduced surge amplification)
- Suitable for emergency lighting acc. to EN 50172

Benefits

- Flexible configuration via companionSUITE
- Application-oriented operating window for maximum compatibility
- Best energy savings due to low stand-by losses and high efficiency
- Flexible configuration via DALI, ready2mains™ and I-SELECT 2
- Reliability proven by life-time up to 100,000 h and 5-year guarantee

Typical applications

- For linear/area lighting in office applications

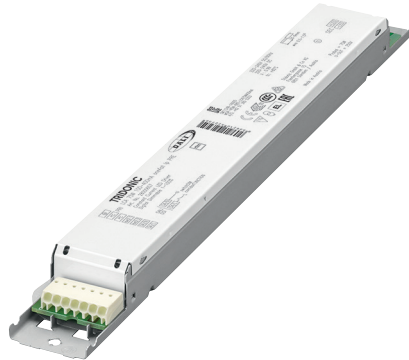

Standards, page 5



Driver LCA 50W 350-1050mA one4all Ip PRE premium series SELV

Technical data

Rated supply voltage	220 – 240 V
AC voltage range	198 – 264 V
DC voltage range	176 – 280 V
Mains frequency	0 / 50 / 60 Hz
Overvoltage protection	320 V AC, 48 h
Typ. current (at 230 V, 50 Hz, full load) ^① ②	102 – 248 mA
Typ. current (220 V, 0 Hz, full load, 15 % dimming level) ^②	71.5 mA
Leakage current (at 230 V, 50 Hz, full load) ^① ②	< 440 µA
Max. input power	56.5 W
Typ. efficiency (at 230 V / 50 Hz / full load) ^②	91 %
λ (at 230 V, 50 Hz, full load) ^①	0.98
Typ. power input on stand-by ^③	< 0.15 W
Typ. input current in no-load operation	33 mA
Typ. input power in no-load operation	0.42 W
In-rush current (peak / duration)	35 A / 170 µs
THD (at 230 V, 50 Hz, full load) ^①	< 61 %
Starting time (at 230 V, 50 Hz, full load) ^①	< 0.6 s
Starting time (DC mode)	< 0.3 s
Switchover time (AC/DC) ^②	< 0.2 s
Turn off time (at 230 V, 50 Hz, full load)	< 20 ms
Output current tolerance ^③ ④	± 3 %
Max. output current peak (non-repetitive)	≤ output current + 40 %
Output LF current ripple (< 120 Hz)	± 5 %
Output P _{st} ^{LM} (at full load)	≤ 1
Output SVM (at full load)	≤ 0.4
Max. output voltage (no-load voltage)	60 V
Dimming range	1 – 100 %
Mains surge capability (between L – N)	1 kV
Mains surge capability (between L/N – PE)	2 kV
Surge voltage at output side (against PE)	< 500 V
Type of protection	IP20
Life-time	up to 100,000 h
Dimensions L x W x H	360 x 30 x 21 mm

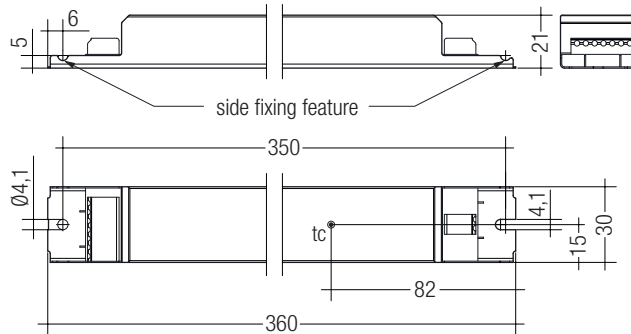

Ordering data

Type	Article number	Packaging carton	Packaging pallet	Weight per pc.
LCA 50W 350-1050mA one4all Ip PRE	28000656	10 pc(s).	760 pc(s).	0.244 kg

Specific technical data

Type	Output current ^①	Min. forward voltage	Max. forward voltage	Max. output power	Typ. power consumption (at 230 V, 50 Hz, full load)	Typ. current consumption (at 230 V, 50 Hz, full load)	Max. casing temperature tc	Ambient temperature ta max.	I-SELECT 2 resistor value ^②
LCA 50W 350-1050mA one4all Ip PRE	350 mA	20 V	50 V	175 W	20.9 W	102 mA	85 °C	-25 ... +70 °C	open
	400 mA	20 V	50 V	200 W	23.5 W	112 mA	85 °C	-25 ... +70 °C	12.50 kΩ
	450 mA	20 V	50 V	22.5 W	26.2 W	123 mA	85 °C	-25 ... +70 °C	1111 kΩ
	500 mA	20 V	50 V	25.0 W	28.8 W	133 mA	85 °C	-25 ... +70 °C	10.00 kΩ
	550 mA	20 V	50 V	27.5 W	31.4 W	144 mA	85 °C	-25 ... +70 °C	9.09 kΩ
	600 mA	20 V	50 V	30.0 W	34.0 W	155 mA	85 °C	-25 ... +70 °C	8.33 kΩ
	650 mA	20 V	50 V	32.5 W	36.6 W	166 mA	85 °C	-25 ... +70 °C	7.69 kΩ
	700 mA	20 V	50 V	35.0 W	39.2 W	177 mA	85 °C	-25 ... +70 °C	7.14 kΩ
	750 mA	20 V	50 V	37.5 W	41.9 W	188 mA	80 °C	-25 ... +65 °C	6.67 kΩ
	800 mA	20 V	50 V	40.0 W	44.6 W	200 mA	80 °C	-25 ... +65 °C	6.25 kΩ
	850 mA	20 V	50 V	42.5 W	47.2 W	211 mA	80 °C	-25 ... +65 °C	5.88 kΩ
	900 mA	20 V	50 V	45.0 W	49.9 W	223 mA	80 °C	-25 ... +65 °C	5.56 kΩ
	950 mA	20 V	50 V	47.5 W	52.4 W	233 mA	80 °C	-25 ... +65 °C	5.26 kΩ
	1,000 mA	20 V	50 V	50.0 W	55.3 W	245 mA	80 °C	-25 ... +65 °C	5.00 kΩ
	1,050 mA	20 V	48 V	50.0 W	56.0 W	248 mA	80 °C	-25 ... +65 °C	short circuit (0 Ω)

① Valid at 100 % dimming level.

② Depending on the selected output current.

③ Depending on the DALI traffic at the interface.

④ The table only lists a number of possible operating points but does not cover each single point. The output current can be set within the total value range in 1-mA-steps.

⑤ Not compatible with I-SELECT (generation 1). Calculated resistor value.

⑥ Output current is mean value.

⑦ Valid for immediate change of power supply type otherwise the starting time is valid.

Product description

- Ready-for-use resistor to set output current value
- Compatible with LED Driver featuring I-SELECT 2 interface; not compatible with I-SELECT (generation 1)
- Resistor is base insulated
- Resistor power 0.25 W
- Current tolerance $\pm 2\%$ additional to output current tolerance
- Compatible with LED Driver series PRE and EXC

Example of calculation

- $R [k\Omega] = 5 V / I_{out} [mA] \times 1000$
- E96 resistor value used
- Resistor value tolerance $\leq 1\%$; resistor power $\geq 0.1 W$; base insulation necessary
- When using a resistor value beyond the specified range, the output current will automatically be set to the minimum value (resistor value too big), respectively to the maximum value (resistor value too small)

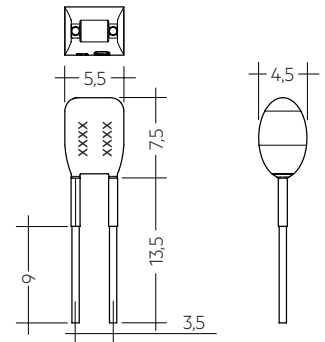

Ordering data

Type	Article number	Colour	Marking	Current	Resistor value	Packaging bag	Weight per pc.
I-SELECT 2 PLUG 350MA BL	28001110	Blue	0350 mA	350 mA	14.30 k Ω	10 pc(s).	0.001 kg
I-SELECT 2 PLUG 375MA BL	28001111	Blue	0375 mA	375 mA	13.30 k Ω	10 pc(s).	0.001 kg
I-SELECT 2 PLUG 400MA BL	28001112	Blue	0400 mA	400 mA	12.40 k Ω	10 pc(s).	0.001 kg
I-SELECT 2 PLUG 425MA BL	28001251	Blue	0425 mA	425 mA	11.80 k Ω	10 pc(s).	0.001 kg
I-SELECT 2 PLUG 450MA BL	28001113	Blue	0450 mA	450 mA	11.00 k Ω	10 pc(s).	0.001 kg
I-SELECT 2 PLUG 475MA BL	28001252	Blue	0475 mA	475 mA	10.50 k Ω	10 pc(s).	0.001 kg
I-SELECT 2 PLUG 500MA BL	28001114	Blue	0500 mA	500 mA	10.00 k Ω	10 pc(s).	0.001 kg
I-SELECT 2 PLUG 525MA BL	28001960	Blue	0525 mA	525 mA	9.53 k Ω	10 pc(s).	0.001 kg
I-SELECT 2 PLUG 550MA BL	28001115	Blue	0550 mA	550 mA	9.09 k Ω	10 pc(s).	0.001 kg
I-SELECT 2 PLUG 600MA BL	28001116	Blue	0600 mA	600 mA	8.25 k Ω	10 pc(s).	0.001 kg
I-SELECT 2 PLUG 650MA BL	28001117	Blue	0650 mA	650 mA	7.68 k Ω	10 pc(s).	0.001 kg
I-SELECT 2 PLUG 700MA BL	28001118	Blue	0700 mA	700 mA	7.15 k Ω	10 pc(s).	0.001 kg
I-SELECT 2 PLUG 750MA BL	28001119	Blue	0750 mA	750 mA	6.65 k Ω	10 pc(s).	0.001 kg
I-SELECT 2 PLUG 800MA BL	28001120	Blue	0800 mA	800 mA	6.19 k Ω	10 pc(s).	0.001 kg
I-SELECT 2 PLUG 850MA BL	28001121	Blue	0850 mA	850 mA	5.90 k Ω	10 pc(s).	0.001 kg
I-SELECT 2 PLUG 900MA BL	28001122	Blue	0900 mA	900 mA	5.62 k Ω	10 pc(s).	0.001 kg
I-SELECT 2 PLUG 950MA BL	28001123	Blue	0950 mA	950 mA	5.23 k Ω	10 pc(s).	0.001 kg
I-SELECT 2 PLUG 1000MA BL	28001124	Blue	1000 mA	1000 mA	4.99 k Ω	10 pc(s).	0.001 kg
I-SELECT 2 PLUG 1050MA BL	28001125	Blue	1050 mA	1050 mA	4.75 k Ω	10 pc(s).	0.001 kg
I-SELECT 2 PLUG MAX BL	28001099	Blue	MAX	MAX	0.00 k Ω	10 pc(s).	0.001 kg

1. Standards

EN 55015
 EN 61000-3-2
 EN 61000-3-3
 EN 61347-1
 EN 61347-2-13
 EN 62384
 EN 61547
 EN 62386-101 (DALI-2)
 EN 62386-102 (DALI-2)
 EN 62386-207 (DALI-2, including part 251, 252, 253)
 According to EN 50172 for use in central battery systems
 According to EN 60598-2-22 suitable for emergency lighting installations

2. Thermal details and life-time

2.1 Expected life-time

Expected life-time							
Type	Output current	ta	50 °C	55 °C	60 °C	65 °C	70 °C
LCA 50W 350-1050mA one4all Ip PRE	350 mA	tc	65 °C	70 °C	75 °C	80 °C	85 °C
		Life-time	> 100,000 h	> 100,000 h	> 100,000 h	79,000 h	58,000 h
	>350 – 500 mA	tc	65 °C	70 °C	75 °C	80 °C	85 °C
		Life-time	> 100,000 h	> 100,000 h	> 100,000 h	75,000 h	55,000 h
	>500 – 700 mA	tc	65 °C	70 °C	75 °C	80 °C	85 °C
		Life-time	> 100,000 h	> 100,000 h	94,000 h	69,000 h	50,000 h
>700 – 900 mA	tc	65 °C	70 °C	75 °C	80 °C	x	
	Life-time	> 100,000 h	> 100,000 h	85,000 h	62,000 h	x	
>900 – 1,050 mA	tc	65 °C	70 °C	75 °C	80 °C	x	
	Life-time	> 100,000 h	> 100,000 h	74,000 h	54,000 h	x	

The LED Driver is designed for a life-time stated above under reference conditions and with a failure probability of less than 10 %.

The relation of tc to ta temperature depends also on the luminaire design.

If the measured tc temperature is approx. 5 K below tc max., ta temperature should be checked and eventually critical components (e.g. ELCAP) measured. Detailed information on request.

3. Installation / wiring

3.1 Circuit diagram

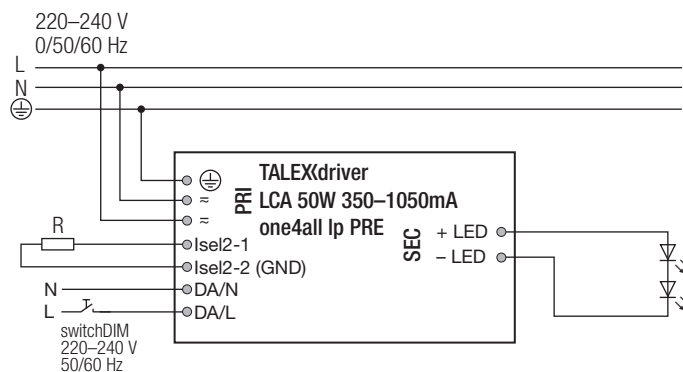
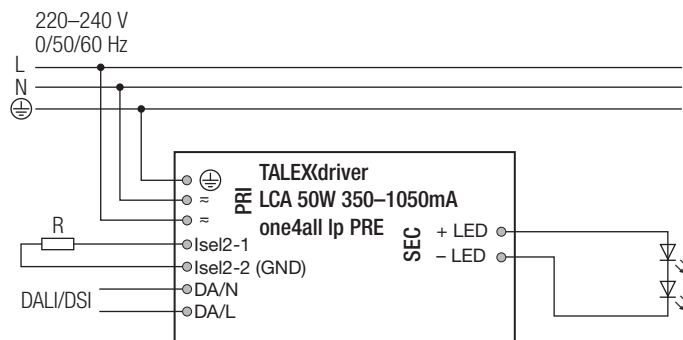

For wiring in dimming operation with ready2mains refer to the ready2mains Gateway data sheet.

3.2 Wiring type and cross section

Solid wire with a cross section of 0.5 – 1.5 mm². Strip 8 – 9 mm of insulation from the cables to ensure perfect operation of terminals.

LED module/LED Driver/supply

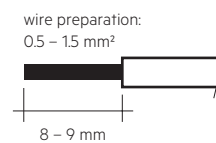

3.3 Loose wiring

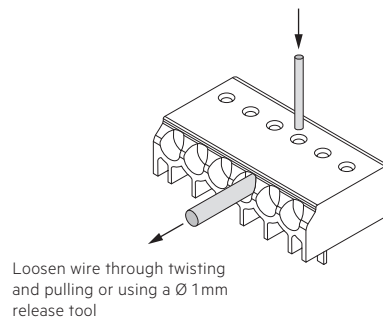

3.4 Wiring guidelines

- Run the secondary lines separately from the mains connections and lines to achieve good EMC performance.
- The max. secondary cable length is 2 m (4 m circuit), this applies for LED output as well as for I-SELECT 2.
- For good EMC performance, keep the LED wiring as short as possible.
- Secondary switching is not permitted.
- The LED Driver has no inverse-polarity protection on the secondary side. Wrong polarity can damage LED modules with no inverse-polarity protection.
- Wrong wiring of the LED Driver can lead to malfunction or irreparable damage.
- To avoid the damage of the Driver, the wiring must be protected against short circuits to earth (sharp edged metal parts, metal cable clips, louver, etc.).

3.5 Hot plug-in

Hot plug-in is not supported due to residual output voltage of > 0 V. If a LED load is connected the device has to be restarted before the output will be activated again. This can be done via mains reset or via interface (DALI, DSI, switchDIM, ready2mains).

3.6 Earth connection

The earth connection is conducted as protection earth (PE). The LED Driver can be earthed via earth terminal or metal housing. If the LED Driver will be earthed, protection earth (PE) has to be used. There is no earth connection required for the functionality of the LED Driver. Earth connection is recommended to improve following behaviour:

- Electromagnetic interferences (EMI)
- LED glowing at stand-by
- Transmission of mains transients to the LED output

In general it is recommended to earth the LED Driver if the LED module is mounted on earthed luminaire parts respectively heat sinks and thereby representing a high capacity against earth.

3.7 I-SELECT 2 resistors connected via cable

For details see:
http://www.tridonic.com/com/en/download/technical/LCA_PRE_LC_EXC_ProductManual_en.pdf.

4. Electrical values

4.1 Operating window

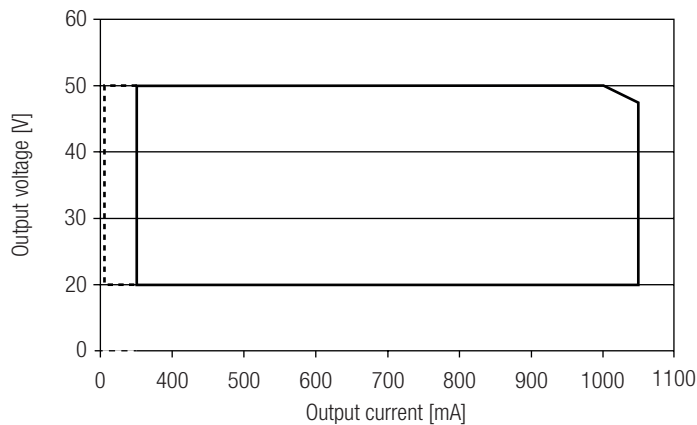

— Operating window 100 %
- - - - - Operating window dimmed

Make sure that the LED Driver is operated within the given window under all operating conditions. Special attention needs to be paid at dimming and DC emergency operation as the forward voltage of the connected LED modules varies with the dimming level, due to the implemented amplitude dimming technology. Coming below the specified minimum output voltage of the LED Driver may cause the device to shut-down. See chapter "6.11 Light level in DC operation" for more information.

4.2 Efficiency vs load

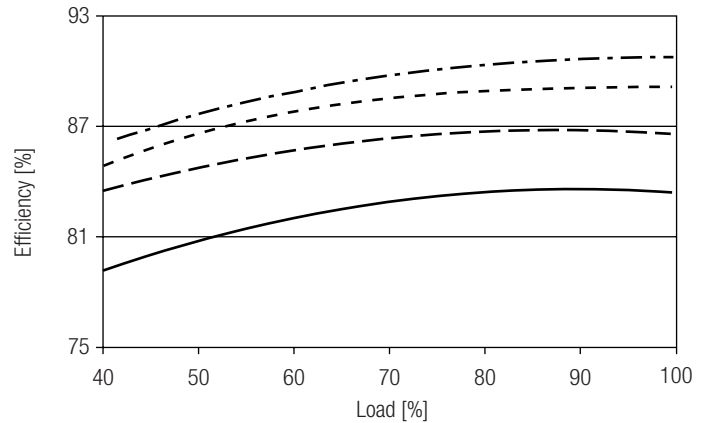

4.3 Power factor vs load

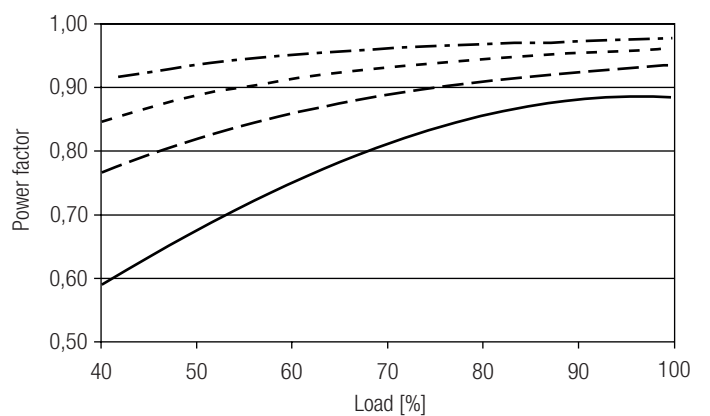

4.4 THD vs load

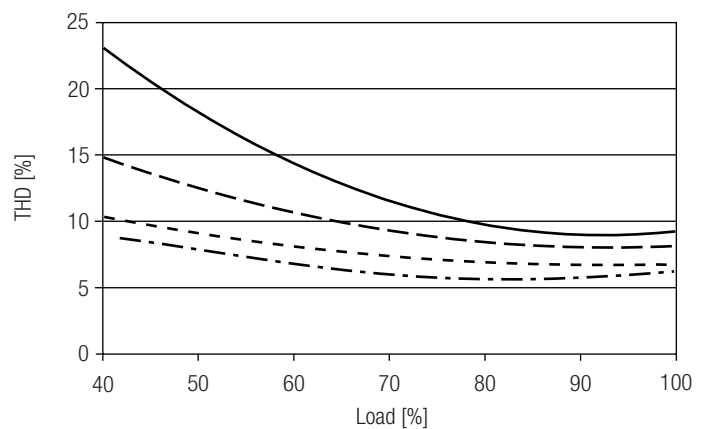

— 350 mA
- - - 500 mA
- - - - 700 mA
- - - - - 1050 mA

100 % load corresponds to the max. output power (full load) according to the table on page 2.

4.5 Maximum loading of automatic circuit breakers in relation to inrush current

Automatic circuit breaker type	C10	C13	C16	C20	B10	B13	B16	B20	Inrush current	
Installation Ø	1.5 mm ²	1.5 mm ²	2.5 mm ²	2.5 mm ²	1.5 mm ²	1.5 mm ²	2.5 mm ²	2.5 mm ²	I_{max}	time
LCA 50W 350-1050mA one4all Ip PRE	21	28	35	45	13	17	21	27	35 A	170 µs

This are max. values calculated out of inrush current! Please consider not to exceed the maximum rated continuous current of the circuit breaker. Calculation uses typical values from ABB series S200 as a reference. Actual values may differ due to used circuit breaker types and installation environment.

4.6 Harmonic distortion in the mains supply (at 230 V / 50 Hz and full load) in %

	THD	3.	5.	7.	9.	11.
LCA 50W 350-1050mA one4all Ip PRE	< 6	< 5	< 1	< 3	< 3	< 2

4.7 Dimming

Dimming range 1% to 100 %

Digital control with:

- DSI signal: 8 bit Manchester Code
Speed 1% to 100% in 1.4 s
 - DALI signal: 16 bit Manchester Code
Speed 1% to 100% in 0.2 s
- Programmable parameter:
Minimum dimming level
Maximum dimming level
Default minimum = 1%
Programmable range $1\% \leq \text{MIN} \leq 100\%$
Default maximum = 100%
Programmable range $100\% \geq \text{MAX} \geq 1\%$

Dimming curve is adapted to the eye sensitiveness.
Dimming is realized by amplitude dimming.

4.8 Dimming characteristics

Digital dimming value

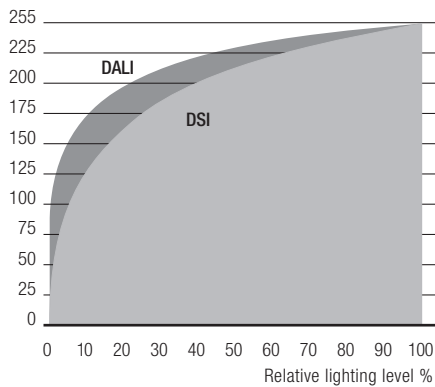

Dimming characteristics as seen by the human eye

5. Software / Programming / Interfaces

5.1 Software / programming

With appropriate software and interface different functions can be activated and various parameters can be configured in the LED Driver. The Driver supports the following software and interfaces:

Software / hardware for configuration:

- companionSUITE (deviceGENERATOR, deviceCONFIGURATOR, deviceANALYSER)
- masterCONFIGURATOR
- ready2mains Programmer

Interfaces for data transfer:

- Control input DALI
- Control input ready2mains

5.2 Control input DALI

The control input is non-polar for digital control signals (DALI). The control signal is not SELV. The control cable has to be installed in accordance to the requirements of low voltage installations.

Digital control with:

- DALI signal: 16 bit
- DSI signal: 8 bit

5.3 Control input ready2mains (L, N)

The digital ready2mains protocol is modulated onto the mains signal which is wired to the mains terminal (L and N).

The configuration is done via the ready2mains Programmer, either directly at the Programmer itself or via a respective software tool. For details on the configuration via ready2mains see the technical information of the Programmer and its tools.

Following tools can be used:

- deviceCONFIGURATOR (companionSUITE)
- masterCONFIGURATOR
- ready2mains Programmer

5.4 I-SELECT 2

By inserting a suitable resistor into the I-SELECT 2 interface, the current value can be adjusted. The relationship between output current and resistor value can be found in the chapter "Accessories I-SELECT 2 Plugs". If the resistor is connected by wires a consistent base insulation must be ensured. Furthermore, a max. wire length of 2 m may not be exceeded and potential interferences have to be avoided.

Resistors for the main output current values can be ordered from Tridonic (see accessories).

6. Functions

⊙ companionSUITE:

















DALI-USB, ready2mains Programmer

The companionSUITE with deviceGENERATOR, deviceCONFIGURATOR and deviceANALYSER is available via our WEB page:
<https://www.tridonic.com/com/en/products/companionsuite.asp>

◇ masterCONFIGURATOR:

DALI-USB, ready2mains Programmer (in DALI mode)

The masterCONFIGURATOR is available via our WEB page:
<https://www.tridonic.com/com/en/software-masterconfigurator.asp>

Icon	Function	DALI-2	ready2mains
	OEM Identification	⊙ ◇	⊙
	OEM GTIN	⊙ ◇	⊙
	Luminaire data	⊙ -	-
	LED current	⊙ ◇	⊙
	Device operating mode	⊙ ◇	⊙
	switchDIM	⊙ ◇	⊙
	corridorFUNCTION	⊙ ◇	⊙
	Constant light output (CLO)	⊙ ◇	⊙
	DC level	⊙ ◇	⊙
	Enhanced power on level (ePOL)	⊙ ◇	⊙
	DALI default parameters	⊙ ◇	-
	Scenes and groups	⊙ ◇	-
	fade2zero	⊙ -	-
	Power-up fading	⊙ -	-
	Intelligent voltage guard (IVG)	⊙ ◇	⊙
	Dimming curve	⊙ -	-

6.1 OEM Identification



The OEM (Original Equipment Manufacturer) can set his own identification number.

DALI Part 251: Memory bank 1 extension.

6.2 OEM GTIN



The Original Equipment Manufacturer (OEM) can set his own Global Trade Item Number (GTIN).

DALI Part 251: Memory bank 1 extension.

6.3 Luminaire data



This function provides the asset management with accurate data about the luminaire.

DALI Part 251: Memory bank 1 extension.

6.4 LED current



The LED output current must be adapted to the connected LED module. The value is limited by the current range of the respective device.

The output current of the LED Driver can be adjusted in a certain range. For adjustment there are 4 options available.

Option 1: DALI
Adjustment is done by companionSUITE or by masterCONFIGURATOR.

Option 2: I-SELECT 2
By inserting a suitable resistor into the I-SELECT 2 interface, the current value can be adjusted.

Option 3: ready2mains
Adjustment is done by the ready2mains programmer and the corresponding configuration software (see ready2mains documentation).

The priority for current adjustment methods is DALI (highest priority), I-SELECT 2 and ready2mains (lowest priority).

6.5 Device operating mode



A Tridonic Driver supports several control signals. These control signals are automatically detected and the mode is adapted. If only one special device mode is required, this mode can be selected. "Automatic detection" is the default setting.

6.6 switchDIM



Integrated switchDIM function allows a direct connection of a pushbutton for dimming and switching.

Brief push (< 0.6 s) switches LED Driver ON and OFF. The dimm level is saved at power-down and restored at power-up. When the pushbutton is held, LED modules are dimmed. After repush the LED modules are dimmed in the opposite direction.

In installations with LED Drivers with different dimming levels or opposite dimming directions (e.g. after a system extension), all LED Drivers can be synchronized to 50% dimming level by a 10 s push.

Use of pushbutton with indicator lamp is not permitted.

6.7 corridorFUNCTION



With the corridorFUNCTION and a commercially available motion detector, it is easy to adapt the lighting in one area to its use.

That is, when the area is entered by a person, the lighting dims instantly to the desired brightness and is available in full strength.

After the area is left by the person, the brightness dims slowly to a smaller value or switches off completely.

The individual parameters of the desired profile, such as brightness values or delay times, can be adjusted flexibly and individually.

6.8 Constant Light Output (CLO)



With this function the light output of the LED module can be kept equal over the life-time.

The light output of an LED module reduces over the course of its lifetime.

The Constant Light Output (CLO) function compensates for this natural decline by constantly increasing the output current of the LED Driver throughout its lifetime.

CLO shall be achieved by limitation of the LED current at the commissioning of the LED Driver and providing a linear interpolation of the current over the time, depending on the data points given by the user.

6.9 DC operation



In emergency light systems with a central battery supply the DC recognition function uses the input voltage to detect if emergency mode is present. The LED Driver then automatically switches to DC mode and dims the light to the defined DC level.

Without DC recognition different and more complex solutions would have to be applied in order to detect emergency mode.

DC recognition is integrated in the device as standard.

No additional commissioning is necessary for activation.



This is a safety-relevant parameter.

The setting is relevant for the dimensioning of the central battery system.

The LED Driver is designed to operate on DC voltage and pulsed DC voltage. For a reliable operation, make sure that also in DC emergency operation the LED Driver is run within the specified conditions as stated in chapter "4.1 operating window".

Light output level in DC operation: programmable 1 – 100 %
(factory default = 15 %, EOF_i = 0.13).

The voltage-dependent input current of Driver incl. LED module is depending on the used load.

The voltage-dependent no-load current of Driver (without or defect LED module) is for:

AC: < 32.8 mA

DC: < 2.8 mA

In DC operation dimming mode can be activated.

If Dimming on DC is activated the requirements of the DC recognition function are ignored.

Even if DC is detected, the LED Driver continues to behave as in AC mode

- The present dimming level is retained
- An emergency light level defined for the DC recognition function (DC level) is ignored
- Control signals via DALI continue to be executed

If Dimming on DC is activated then emergency mode is not recognised. The device no longer automatically switches to the emergency light level.

6.10 Enhanced power on level (ePOL)



The Enhanced Power On Level parameter defines the power level that is set automatically when power is restored after a power failure.

The Enhanced Power On Level can be set to a fixed value (0 – 100 %) or can recall the memory value.

The memory value is the last value the LED Driver was set to before the power failure.

This value applies not only in DALI device operating mode, but also in the device operating mode switchDIM.

6.11 DALI default parameters



In order for all luminaires to react the same for each operation (switching, dimming, scene recall ...), these values must be set the same.

These DALI standard parameters are supported by every DALI-2 device.

6.12 Scenes and groups



Each device can be a member of up to 16 groups.

Also, 16 different scene values can be stored in each device.

6.13 fade2zero



When the Driver is switched off, fade2zero allows a smooth dimming down to almost zero.

Activate the fade2zero function when programming with companionSUITE and set a DALI fade time. fade2zero only works if the minimum dimming level of the Driver is the default value.

The device then dims to far below the limit of its working window (dimming range).

This function is deactivated by default.

6.14 Power-up fading



The power-up function offers the opportunity to modify the on behavior. The time for fading on can be adjusted in a range of 0.2 to 16 seconds. According to this value, the device dims from 0 % up to the power-on level. By factory default no fading time is set (= 0 seconds).

6.15 Dimming curve



DALI:

The desired dimming behaviour is selected via two different dimming curves (logarithmic or linear).

The default setting of the dimming behaviour is logarithmic.

7. Protective features

7.1 Intelligent temperature guard (ITG)



The Intelligent temperature guard (ITG) function provides effective protection against thermal overloads by slowly reducing the output if a defined internal temperature is exceeded.

The reduction of overtemperatures takes place in small steps every two minutes. As soon as the temperature drops again, the output power is gradually increased every 10 minutes.

On DC operation this function is deactivated to fulfill emergency requirements.

7.2 Intelligent Voltage Guard (IVG)



The Intelligent Voltage Guard (IVG) function warns of possible damage due to overvoltage or undervoltage.

The mains voltage is constantly monitored and if necessary appropriate responses are made:

- If the mains voltage is too low (< 70 V), the LED Driver is switched off.
- At a mains voltage between 70 and 140 V, the LED Driver switches off and on again on a non-cyclic basis.
- In case of an overvoltage (> 318 V), the LED Driver sends feedback via DALI.

7.3 Short-circuit behaviour

In case of a short-circuit at the LED output the LED output is switched off. After restart of the LED Driver the output will be activated again. The restart can either be done via mains reset or via interface (DALI, DSI, switchDIM, ready2mains)

7.4 No-load operation

The LED Driver will not be damaged in no-load operation. The output will be deactivated and is therefore free of voltage. If a LED load is connected the device has to be restarted before the output will be activated again.

7.5 Overload protection

If the output voltage range is exceeded the LED Driver turns off the LED output. After restart of the LED Driver the output will be activated again. The restart can either be done via mains reset or via interface (DALI, DSI, switchDIM, ready2mains).

7.6 Insulation between terminals

Insulation	Mains	PE	LED	DALI
Mains	–	basic	double	basic
PE	basic	–	basic	basic
LED	double	basic	–	double
DALI	basic	basic	double	–

basic ... represents basic insulation.

double ... represents double or reinforced insulation.

8. Miscellaneous

8.1 Insulation and electric strength testing of luminaires

Electronic devices can be damaged by high voltage. This has to be considered during the routine testing of the luminaires in production.

According to IEC 60598-1 Annex Q (informative only!) or ENEC 303-Annex A, each luminaire should be submitted to an insulation test with 500 V_{DC} for 1 second. This test voltage should be connected between the interconnected phase and neutral terminals and the earth terminal.

The insulation resistance must be at least 2 MΩ.

As an alternative, IEC 60598-1 Annex Q describes a test of the electrical strength with 1500 V_{AC} (or 1.414 x 1500 V_{DC}). To avoid damage to the electronic devices this test must not be conducted.

8.2 Conditions of use and storage

Humidity: 5% up to max. 85%,
not condensed
(max. 56 days/year at 85%)

Storage temperature: -40 °C up to max. +80 °C

The devices have to be acclimatised to the specified temperature range (ta) before they can be operated.

8.3 Maximum number of switching cycles

All LED Driver are tested with 50,000 switching cycles. The actually achieved number of switching cycles is significantly higher.

8.4 Additional information

Additional technical information at www.tridonic.com → Technical Data

Guarantee conditions at www.tridonic.com → Services

Life-time declarations are informative and represent no warranty claim. No warranty if device was opened.

X-ON Electronics

Largest Supplier of Electrical and Electronic Components

Click to view similar products for [LED Power Supplies](#) category:

Click to view products by [Tridonic](#) manufacturer:

Other Similar products are found below :

[PIFC-K250F](#) [PITB-K222A](#) [AC-A60VD24H2.5](#) [ALD-514012PJ134](#) [PWD-60-1-70-P](#) [ESS030W-1050-21](#) [BPOXL 4-12-035](#) [ESS010W-0180-42](#) [ESS010W-0350-24](#) [ESS010W-0200-42](#) [ESM060W-1400-42](#) [ESS010W-0500-12](#) [SLM140W-1.05-130-ZA](#) [ESS015W-0700-18](#) [HVG-240-54AB](#) [OTE 25/220-240/700 PC](#) [OT FIT 30/220-240/700 CS](#) [DAL30W-0600-42-T](#) [HVG-320-48AB](#) [CNB30W-0600-42-CAS](#) [87500757](#) [I-SELECT 2 PLUG 2100MA BL](#) [LCU 48V 75W DC-STR FO](#) [LC 45 W 500-1400 MA FLEXC SC EXC](#) [I-SELECT 2 PLUG 2000MA BL](#) [LC 50/200-350/170 FLEXCC LP SNC3](#) [LCO 14/100-500/38 O4A NF C EXC3](#) [LC 28W 300-700MA 42 FLEXC NF SC EXC3](#) [LC 44/1050/42 FIXC SRL ADV2](#) [LCA 60W 900-1750MA ONE4ALL C PRE](#) [LC 8/180/44 FIXC SR SNC2](#) [LC 19/200-350/54 FLEXC LP SNC4](#) [BXDR-PS-75BS-E116D-01-A](#) [LC 30/500/54 FIXC SR SNC2](#) [LCA 60W 24V ONE4ALL SC PRE SP](#) [LC 60W 75-330MA 310V FLEXC NF H16 EXC4](#) [LC 8/180/42 FIXC PC SR SNC2](#) [LC 10/350/29 FIXC SR SNC2](#) [LC 25/500/43 FIXC SR SNC2](#) [LC 50/100-400/140 PO4A NF H16 PRE3](#) [LC 25/600/42 FIXC SRL ADV2](#) [LCO 24/200-1050/39 NF C ADV3](#) [ELEMENT 35/220...240/900 G3](#) [LC 25W 350-1050MA FLEXC SR EXC](#) [LC 35W 24 ONE4ALL IP PRE](#) [BXDR-PS-25BS-E107D-01-A](#) [LC 17W 250-700MA FLEXC SR EXC](#) [LC 15W 350MA FIXC C SNC](#) [LC 14W 700MA FIXC PC SR SNC2](#) [LC 200W 24V SC SNC](#)