



**TM028N06DF**

**N-Channel Enhancement Mosfet**

<p><b>General Description</b></p> <ul style="list-style-type: none"> <li>• Low <math>R_{DS(ON)}</math></li> <li>• RoHS and Halogen-Free Compliant</li> </ul> <p><b>Applications</b></p> <ul style="list-style-type: none"> <li>• Load switch</li> <li>• PWM</li> </ul>	<p><b>General Features</b></p> <p><math>V_{DS} = 60V</math> <math>I_D = 30A</math></p> <p><math>R_{DS(ON)} = 28m\Omega (typ.) @ V_{GS} = 10V</math></p> <p>100% UIS Tested              100% <math>R_g</math> Tested</p> 
--	--

DF:DFN3x3\_8L

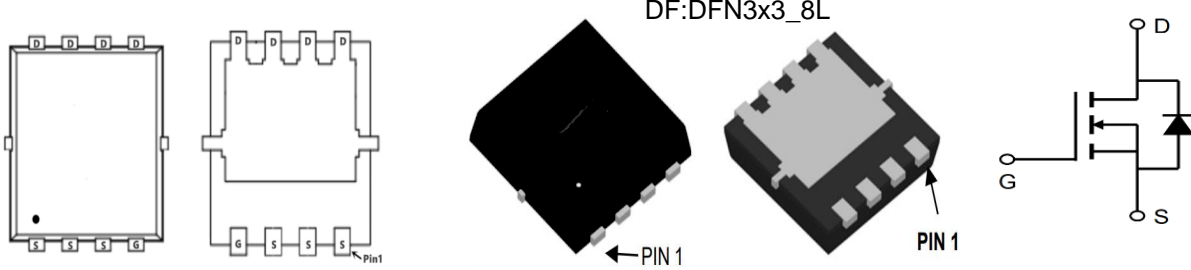

Marking 30N06

**Absolute Maximum Ratings@T<sub>j</sub>=25°C(unless otherwise specified)**

Symbol	Parameter	Max.	Units
V <sub>DS</sub>	Drain-Source Voltage	60	V
V <sub>GS</sub>	Gate-Source Voltage	±20	V
I <sub>D</sub> @T <sub>C</sub> =25°C	Continuous Drain Current, V <sub>GS</sub> @ 10V <sup>1</sup>	30	A
I <sub>D</sub> @T <sub>C</sub> =100°C	Continuous Drain Current, V <sub>GS</sub> @ 10V <sup>1</sup>	16	A
IDM	Pulsed Drain Current	74	A
I <sub>AS</sub>	Avalanche Current	13	A
E <sub>AS</sub>	Single Pulsed Avalanche Energy	22	mJ
P <sub>D</sub> @T <sub>C</sub> =25°C	Power Dissipation	31.3	W
T <sub>J</sub> , T <sub>STG</sub>	Operating and Storage Temperature Range	-55 to +175	°C
R <sub>θJA</sub>	Thermal Resistance Junction-Ambient <sup>1</sup>	62.5	°C/W
R <sub>θJC</sub>	Thermal Resistance Junction-Case <sup>1</sup>	4	°C/W

**TM028N06DF**

**N-Channel Enhancement Mosfet**

**Electrical Characteristics (T<sub>J</sub>=25°C, unless otherwise noted)**

Symbol	Parameter	Conditions	Min.	Typ.	Max.	Unit
BVDSS	Drain-Source Breakdown Voltage	V <sub>GS</sub> =0V, I <sub>D</sub> =250uA	60	65	---	V
ΔBVDSS/ΔT <sub>J</sub>	BVDSS Temperature Coefficient	Reference to 25°C, I <sub>D</sub> =1mA	---	0.044	---	V/°C
RDS(ON)	Static Drain-Source On-Resistance <sup>2</sup>	V <sub>GS</sub> =10V, I <sub>D</sub> =15A	---	28	36	mΩ
		V <sub>GS</sub> =4.5V, I <sub>D</sub> =7A	---	38	45	mΩ
V <sub>GS(th)</sub>	Gate Threshold Voltage	V <sub>GS</sub> =V <sub>DS</sub> , I <sub>D</sub> =250uA	1.2	1.6	2.5	V
ΔV <sub>GS(th)</sub>	V <sub>GS(th)</sub> Temperature Coefficient		---	-4.8	---	mV/°C
IDSS	Drain-Source Leakage Current	V <sub>DS</sub> =48V, V <sub>GS</sub> =0V, T <sub>J</sub> =25°C	---	---	1	uA
		V <sub>DS</sub> =48V, V <sub>GS</sub> =0V, T <sub>J</sub> =55°C	---	---	5	
IGSS	Gate-Source Leakage Current	V <sub>GS</sub> =±20V, V <sub>DS</sub> =0V	---	---	±100	nA
g <sub>fs</sub>	Forward Transconductance	V <sub>DS</sub> =5V, I <sub>D</sub> =15A	---	25.3	---	S
R <sub>g</sub>	Gate Resistance	V <sub>DS</sub> =0V, V <sub>GS</sub> =0V, f=1MHz	---	2.5	---	Ω
Q <sub>g</sub>	Total Gate Charge (10V)	V <sub>DS</sub> =48V, V <sub>GS</sub> =10V, I <sub>D</sub> =15A	---	19	---	nC
Q <sub>gs</sub>	Gate-Source Charge		---	2.5	---	
Q <sub>gd</sub>	Gate-Drain Charge		---	5	---	
T <sub>d(on)</sub>	Turn-On Delay Time	V <sub>DD</sub> =30V, V <sub>GS</sub> =10V, R <sub>G</sub> =3.3Ω I <sub>D</sub> =15A	---	2.8	---	ns
T <sub>r</sub>	Rise Time		---	16.6	---	
T <sub>d(off)</sub>	Turn-Off Delay Time		---	21.2	---	
T <sub>f</sub>	Fall Time		---	5.6	---	
C <sub>iss</sub>	Input Capacitance	V <sub>DS</sub> =15V, V <sub>GS</sub> =0V, f=1MHz	---	1027	---	pF
C <sub>oss</sub>	Output Capacitance		---	65	---	
C <sub>rss</sub>	Reverse Transfer Capacitance		---	46	---	
I <sub>S</sub>	Continuous Source Current <sup>1,6</sup>	V <sub>G</sub> =V <sub>D</sub> =0V, Force Current	---	---	20	A
ISM	Pulsed Source Current <sup>2,6</sup>		---	---	40	A
VSD	Diode Forward Voltage <sup>2</sup>	V <sub>GS</sub> =0V, I <sub>S</sub> =1A, T <sub>J</sub> =25°C	---	---	1.2	V
t <sub>rr</sub>	Reverse Recovery Time	IF=15A, dI/dt=100A/μs, T <sub>J</sub> =25°C	---	12.2	---	nS
Q <sub>rr</sub>	Reverse Recovery Charge		---	7.3	---	nC

**Note :**

1. The data tested by surface mounted on a 1 inch<sup>2</sup> FR-4 board with 2OZ copper.
2. The data tested by pulsed, pulse width. The EAS data shows Max. rating.
3. The test cond ≅ 300us duty cycle ≅ 2%, duty cycle ition is T<sub>J</sub>=25°C, V<sub>DD</sub>=48V, V<sub>G</sub>=10V, R<sub>G</sub>=25Ω, L=0.1mH, I<sub>AS</sub>=13A
4. The power dissipation is limited by 175°C junction temperature
5. The data is theoretically the same as I<sub>D</sub> and I<sub>DM</sub>, in real applications, should be limited by total power dissipation.



TM028N06DF

N-Channel Enhancement Mosfet

Typical Characteristics

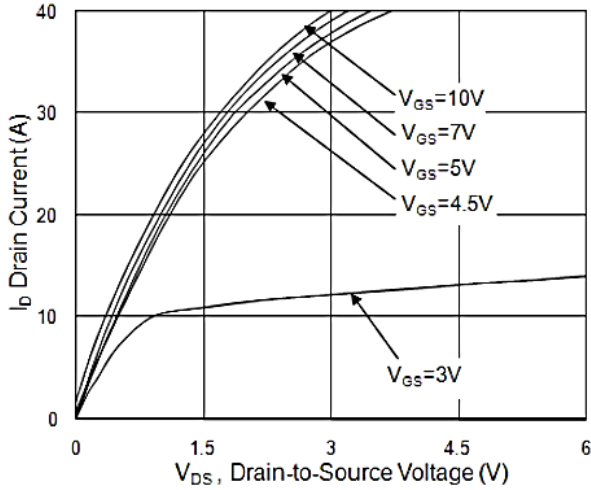

Fig.1 Typical Output Characteristics

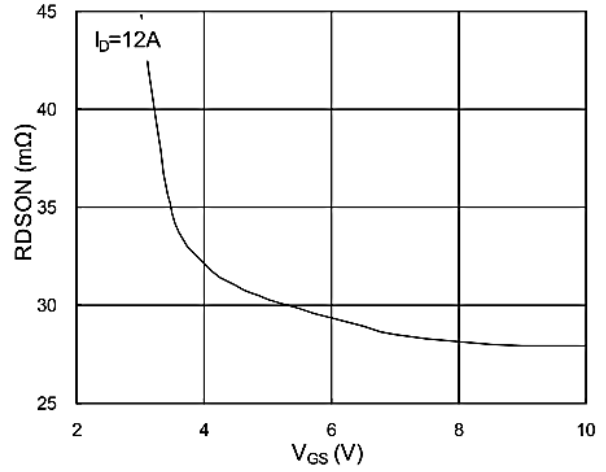

Fig.2 On-Resistance vs. Gate-Source

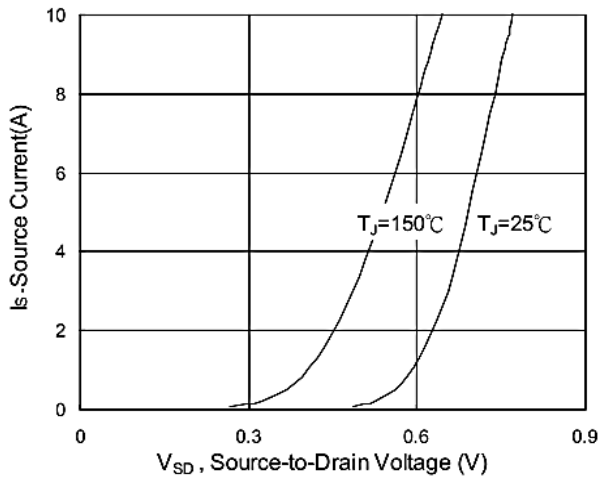

Fig.3 Forward Characteristics Of Reverse

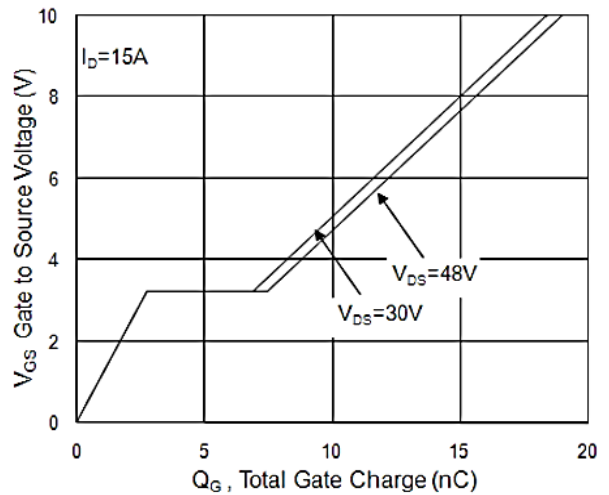

Fig.4 Gate-Charge Characteristics

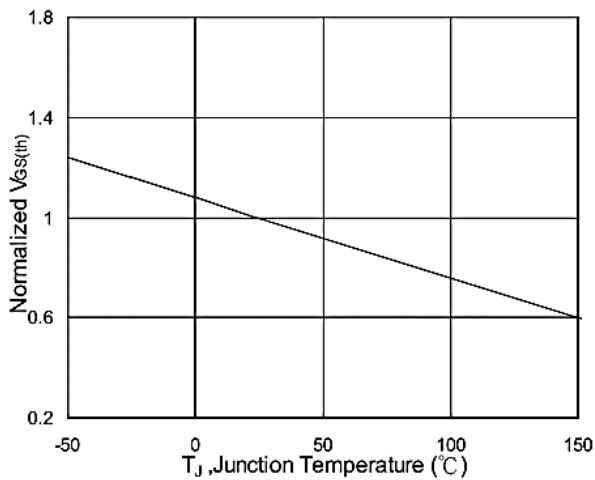

Fig.5 Normalized  $V_{GS(th)}$  vs.  $T_J$

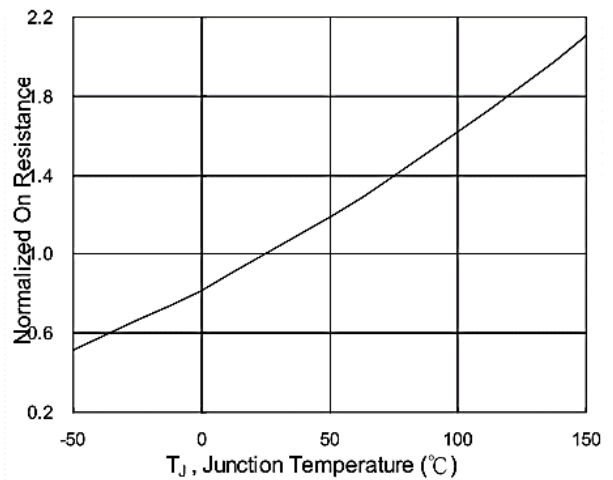

Fig.6 Normalized  $R_{DSON}$  vs.  $T_J$



TM028N06DF

N-Channel Enhancement Mosfet

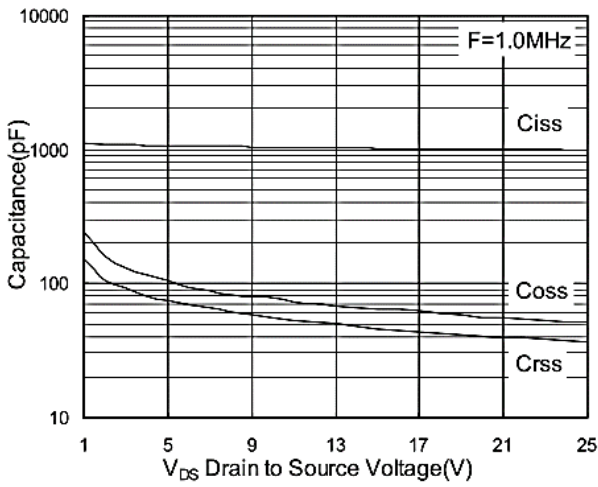

Fig.7 Capacitance

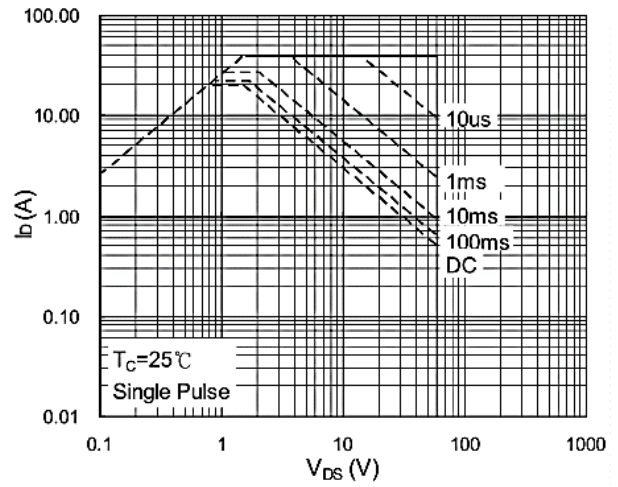

Fig.8 Safe Operating Area

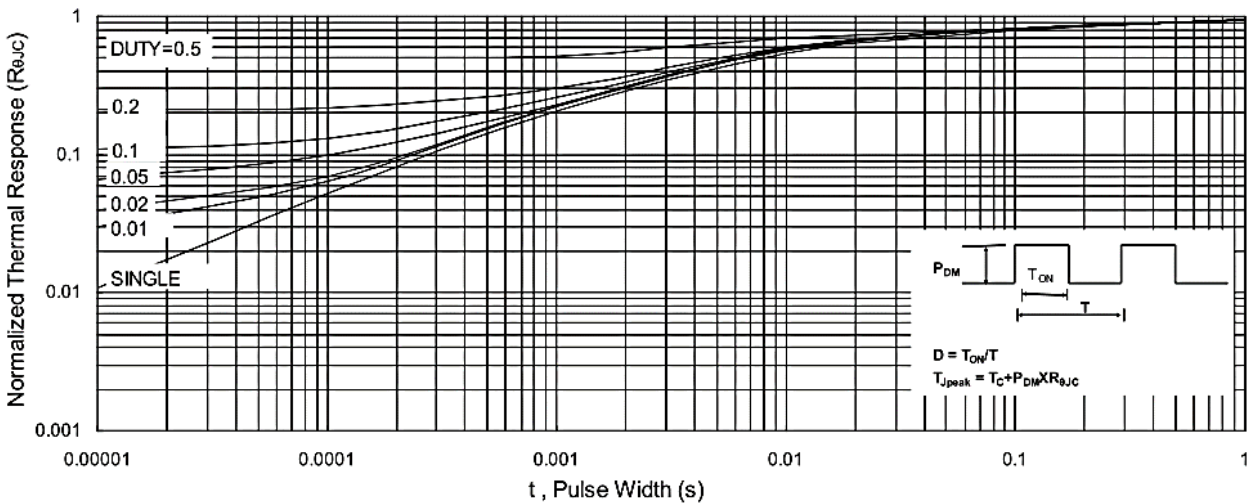

Fig.9 Normalized Maximum Transient Thermal Impedance

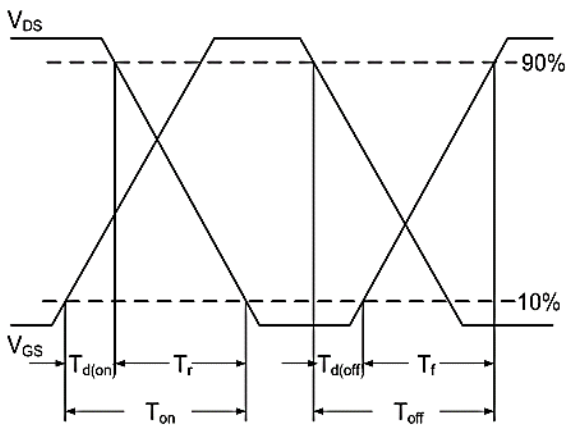

Fig.10 Switching Time Waveform

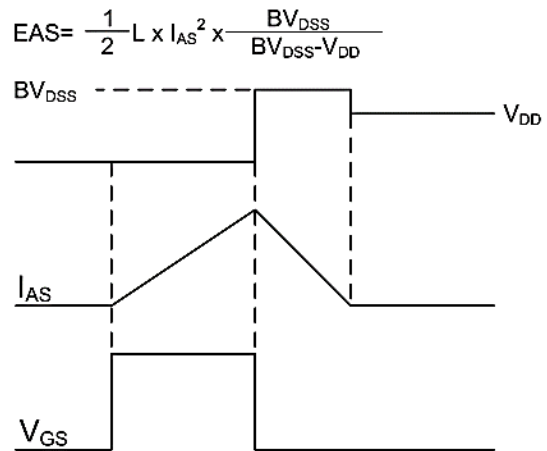
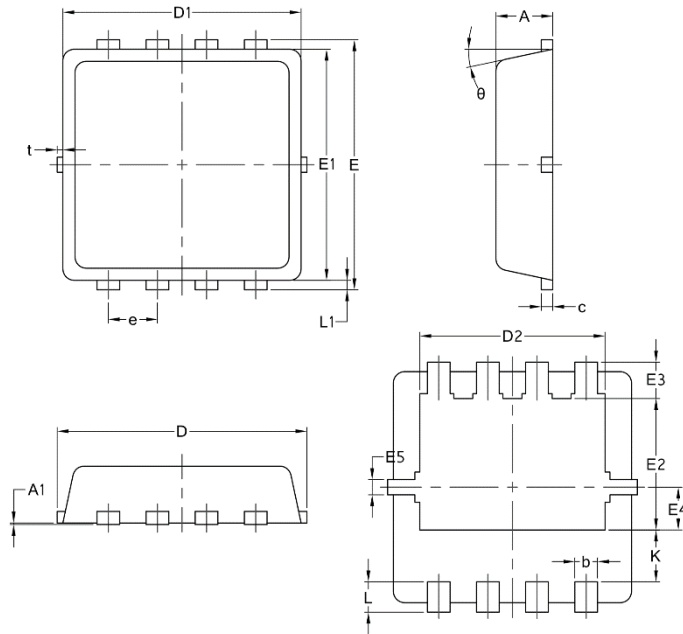

Fig.11 Unclamped Inductive Switching Waveform

## Package Mechanical Data:DFN3x3–8L



Symbol	Common		
	mm		
	Mim	Nom	Max
A	0.70	0.75	0.85
A1	/	/	0.05
b	0.20	0.30	0.40
c	0.10	0.152	0.25
D	3.15	3.30	3.45
D1	3.00	3.15	3.25
D2	2.29	2.45	2.65
E	3.15	3.30	3.45
E1	2.90	3.05	3.20
E2	1.54	1.74	1.94
E3	0.28	0.48	0.65
E4	0.37	0.57	0.77
E5	0.10	0.20	0.30
e	0.60	0.65	0.70
K	0.59	0.69	0.89
L	0.30	0.40	0.50
L1	0.06	0.125	0.20
t	0	0.075	0.13
Φ	10	12	14

## X-ON Electronics

Largest Supplier of Electrical and Electronic Components

*Click to view similar products for [MOSFET](#) category:*

*Click to view products by [Tritech-MOS](#) manufacturer:*

Other Similar products are found below :

[IRFD120](#) [JANTX2N5237](#) [BUK455-60A/B](#) [MIC4420CM-TR](#) [VN1206L](#) [NDP4060](#) [SI4482DY](#) [IPS70R2K0CEAKMA1](#) [SQD23N06-31L-GE3](#)  
[TK16J60W,S1VQ\(O](#) [2SK2614\(TE16L1,Q\)](#) [DMN1017UCP3-7](#) [DMN1053UCP4-7](#) [SQJ469EP-T1-GE3](#) [NTE2384](#) [DMC2700UDMQ-7](#)  
[DMN2080UCB4-7](#) [DMN61D9UWQ-13](#) [US6M2GTR](#) [DMN31D5UDJ-7](#) [DMP22D4UFO-7B](#) [DMN1006UCA6-7](#) [DMN16M9UCA6-7](#)  
[STF5N65M6](#) [IRF40H233XTMA1](#) [STU5N65M6](#) [DMN6022SSD-13](#) [DMN13M9UCA6-7](#) [DMTH10H4M6SPS-13](#) [DMN2990UFB-7B](#)  
[IPB80P04P405ATMA2](#) [2N7002W-G](#) [MCAC30N06Y-TP](#) [MCQ7328-TP](#) [BXP7N65D](#) [BXP4N65F](#) [AOL1454G](#) [WMJ80N60C4](#) [BXP2N20L](#)  
[BXP2N65D](#) [BXT1150N10J](#) [BXT1700P06M](#) [TSM60NB380CP](#) [ROG](#) [RQ7L055BGTCR](#) [DMNH15H110SK3-13](#) [SLF10N65ABV2](#)  
[BSO203SP](#) [BSO211P](#) [IPA60R230P6](#) [IPA60R460CE](#)