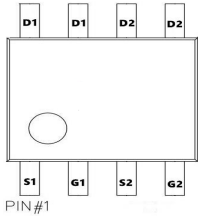
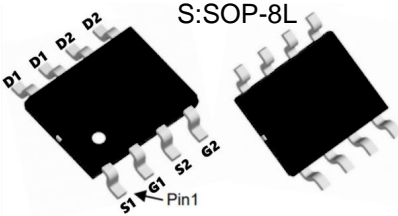
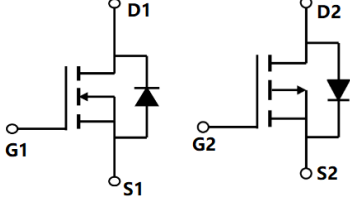

**TM06G06S**

**N+P-Channel Enhancement Mode Mosfet**

<p><b>General Description</b></p> <ul style="list-style-type: none"> <li>• Low <math>R_{DS(ON)}</math></li> <li>• RoHS and Halogen-Free Compliant</li> </ul> <p><b>Applications</b></p> <ul style="list-style-type: none"> <li>• Load switch</li> <li>• PWM</li> </ul>	<p><b>Product Summary</b></p> <p><b>N Channel</b>  <math>V_{DS} = 60V, I_D = 6A</math>  <math>R_{DS(ON)} = 30m\Omega (typ.) @ V_{GS} = 10V</math></p> <p><b>P Channel</b>  <math>V_{DS} = -60V, I_D = -5A</math>  <math>R_{DS(ON)} = 70m\Omega (typ.) @ V_{GS} = -10V</math></p> <p>100% UIS Tested                  100% <math>R_g</math> Tested</p> 
--	---

S: SOP-8L

Marking: 06G06 OR 4559A

**Absolute Maximum Ratings ( $T_C = 25^\circ C$  unless otherwise noted)**

Symbol	Parameter	Rating		Units
		N-Channel	P-Channel	
$V_{DS}$	Drain-Source Voltage	60	-60	V
$V_{GS}$	Gate-Source Voltage	$\pm 20$	$\pm 20$	V
$I_D @ T_A = 25^\circ C$	Continuous Drain Current, $V_{GS} @ 10V^1$	6.0	-5.0	A
$I_D @ T_A = 70^\circ C$	Continuous Drain Current, $V_{GS} @ 10V^1$	4.0	-3.5	A
$I_{DM}$	Pulsed Drain Current <sup>2</sup>	11	-8.5	A
EAS	Single Pulse Avalanche Energy <sup>3</sup>	22.5	35.3	mJ
$I_{AS}$	Avalanche Current	22.6	-26.6	A
$P_D @ T_A = 25^\circ C$	Total Power Dissipation <sup>4</sup>	2.5	2.5	W
$T_{STG}$	Storage Temperature Range	-55 to 150	-55 to 150	$^\circ C$
$T_J$	Operating Junction Temperature Range	-55 to 150	-55 to 150	$^\circ C$

**Thermal Data**

Symbol	Parameter	Typ.	Max.	Unit
$R_{\theta JA}$	Thermal Resistance Junction-Ambient <sup>1</sup>	---	85	$^\circ C/W$
$R_{\theta JC}$	Thermal Resistance Junction-Case <sup>1</sup>	---	62.5	$^\circ C/W$

**TM06G06S**

**N+P-Channel Enhancement Mode Mosfet**

**N-Channel Electrical Characteristics (T<sub>J</sub>=25 , unless otherwise noted)**

Symbol	Parameter	Test Condition	Min.	Typ.	Max.	Units
<b>Off Characteristic</b>						
V <sub>(BR)DSS</sub>	Drain-Source Breakdown Voltage	V <sub>GS</sub> =0V, I <sub>D</sub> =250μA	60	-	-	V
I <sub>DSS</sub>	Zero Gate Voltage Drain Current	V <sub>DS</sub> =60V, V <sub>GS</sub> = 0V,	-	-	1.0	μA
I <sub>GSS</sub>	Gate to Body Leakage Current	V <sub>DS</sub> =0V, V <sub>GS</sub> = ±20V	-	-	±100	nA
<b>On Characteristics</b>						
V <sub>GS(th)</sub>	Gate Threshold Voltage	V <sub>DS</sub> =V <sub>GS</sub> , I <sub>D</sub> =250μA	1.0	1.6	2.5	V
R <sub>DS(on)</sub>	Static Drain-Source on-Resistance <small>note3</small>	V <sub>GS</sub> =10V, I <sub>D</sub> =5A	-	30	40	mΩ
		V <sub>GS</sub> =4.5V, I <sub>D</sub> =3A	-	36	50	
<b>Dynamic Characteristics</b>						
C <sub>iss</sub>	Input Capacitance	V <sub>DS</sub> =25V, V <sub>GS</sub> =0V, f=1.0MHz	-	1148	-	pF
C <sub>oss</sub>	Output Capacitance		-	58.5	-	pF
C <sub>rss</sub>	Reverse Transfer Capacitance		-	49.4	-	pF
Q <sub>g</sub>	Total Gate Charge	V <sub>DS</sub> =30V, I <sub>D</sub> =2.5A, V <sub>GS</sub> =10V	-	20.3	-	nC
Q <sub>gs</sub>	Gate-Source Charge		-	3.7	-	nC
Q <sub>gd</sub>	Gate-Drain("Miller") Charge		-	5.3	-	nC
<b>Switching Characteristics</b>						
t <sub>d(on)</sub>	Turn-on Delay Time	V <sub>DS</sub> =30V, I <sub>D</sub> =5A, R <sub>G</sub> =1.8Ω, V <sub>GS</sub> =10V	-	7.6	-	ns
t <sub>r</sub>	Turn-on Rise Time		-	20	-	ns
t <sub>d(off)</sub>	Turn-off Delay Time		-	15	-	ns
t <sub>f</sub>	Turn-off Fall Time		-	24	-	ns
<b>Drain-Source Diode Characteristics and Maximum Ratings</b>						
I <sub>S</sub>	Maximum Continuous Drain to Source Diode Forward Current		-	-	6	A
I <sub>SM</sub>	Maximum Pulsed Drain to Source Diode Forward Current		-	-	20	A
V <sub>SD</sub>	Drain to Source Diode Forward Voltage	V <sub>GS</sub> =0V, I <sub>S</sub> =5A	-	-	1.2	V
t <sub>rr</sub>	Body Diode Reverse Recovery Time	I <sub>F</sub> =5A, di/dt=100A/μs	-	29	-	ns
Q <sub>rr</sub>	Body Diode Reverse Recovery Charge		-	43	-	nC

- Notes: 1. Repetitive Rating: Pulse Width Limited by Maximum Junction Temperature  
 2. EAS condition : T<sub>J</sub>=25°C, V<sub>DD</sub>=30V, V<sub>G</sub>=10V, L=0.5mH, R<sub>G</sub>=25Ω, I<sub>AS</sub>=8.7A  
 3. Pulse Test: Pulse Width≤300μs, Duty Cycle≤0.5%

**TM06G06S**

**N+P-Channel Enhancement Mode Mosfet**

**P-Channel Electrical Characteristics (T<sub>J</sub>=25 °C, unless otherwise noted)**

Symbol	Parameter	Conditions	Min.	Typ.	Max.	Unit
BV <sub>DSS</sub>	Drain-Source Breakdown Voltage	V <sub>GS</sub> =0V, I <sub>D</sub> =-250uA	-60	---	---	V
R <sub>DS(ON)</sub>	Static Drain-Source On-Resistance <sup>2</sup>	V <sub>GS</sub> =-10V, I <sub>D</sub> =-3.5A	---	70	90	mΩ
		V <sub>GS</sub> =-4.5V, I <sub>D</sub> =-3.1A	---	90	105	
V <sub>GS(th)</sub>	Gate Threshold Voltage	V <sub>GS</sub> =V <sub>DS</sub> , I <sub>D</sub> =-250uA	-1.0	---	-2.5	V
I <sub>DSS</sub>	Drain-Source Leakage Current	V <sub>DS</sub> =-48V, V <sub>GS</sub> =0V, T <sub>J</sub> =25°C	---	---	1	uA
		V <sub>DS</sub> =-48V, V <sub>GS</sub> =0V, T <sub>J</sub> =55°C	---	---	5	
I <sub>GSS</sub>	Gate-Source Leakage Current	V <sub>GS</sub> =±20V, V <sub>DS</sub> =0V	---	---	±100	nA
g <sub>fs</sub>	Forward Transconductance	V <sub>DS</sub> =-5V, I <sub>D</sub> =-3A	---	8.5	---	S
Q <sub>g</sub>	Total Gate Charge (-4.5V)	V <sub>DS</sub> =-48V, V <sub>GS</sub> =-4.5V, I <sub>D</sub> =-3A	---	12.1	---	nC
Q <sub>gs</sub>	Gate-Source Charge		---	2.2	---	
Q <sub>gd</sub>	Gate-Drain Charge		---	6.3	---	
T <sub>d(on)</sub>	Turn-On Delay Time	V <sub>DD</sub> =-15V, V <sub>GS</sub> =-10V, R <sub>G</sub> =3.3Ω, I <sub>D</sub> =-1A	---	9.2	---	ns
T <sub>r</sub>	Rise Time		---	20.1	---	
T <sub>d(off)</sub>	Turn-Off Delay Time		---	46.7	---	
T <sub>f</sub>	Fall Time		---	9.4	---	
C <sub>iss</sub>	Input Capacitance	V <sub>DS</sub> =-15V, V <sub>GS</sub> =0V, f=1MHz	---	1137	---	pF
C <sub>oss</sub>	Output Capacitance		---	76	---	
C <sub>rss</sub>	Reverse Transfer Capacitance		---	50	---	

**Diode Characteristics**

Symbol	Parameter	Conditions	Min.	Typ.	Max.	Unit
I <sub>S</sub>	Continuous Source Current <sup>1,5</sup>	V <sub>G</sub> =V <sub>D</sub> =0V, Force Current	---	---	-6.0	A
V <sub>SD</sub>	Diode Forward Voltage <sup>2</sup>	V <sub>GS</sub> =0V, I <sub>S</sub> =-1A, T <sub>J</sub> =25°C	---	---	-1.2	V

Note :

- 1.The data tested by surface mounted on a 1 inch<sup>2</sup> FR-4 board with 2OZ copper.
- 2.The data tested by pulsed, pulse width ≤ 300us, duty cycle ≤ 2%
- 3.The EAS data shows Max. rating. The test condition is V<sub>DD</sub>=-25V, V<sub>GS</sub>=-10V, L=0.1mH, I<sub>AS</sub>=-24A
- 4.The power dissipation is limited by 150°C junction temperature
- 5.The data is theoretically the same as I<sub>D</sub> and I<sub>DM</sub>, in real applications, should be limited by total power dissipation.

TM06G06S

N+P-Channel Enhancement Mode Mosfet

N-Channel Typical Characteristics

Figure 1: Output Characteristics

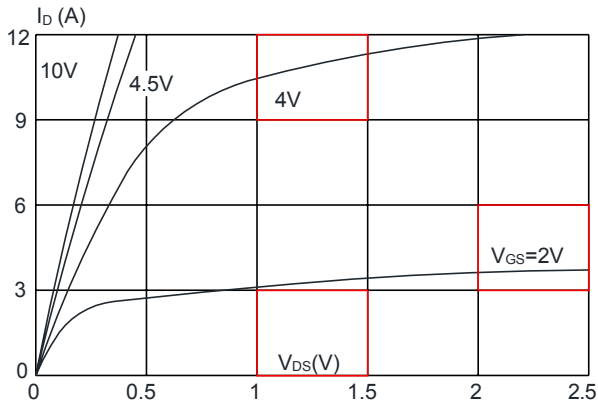

Figure 2: Typical Transfer Characteristics

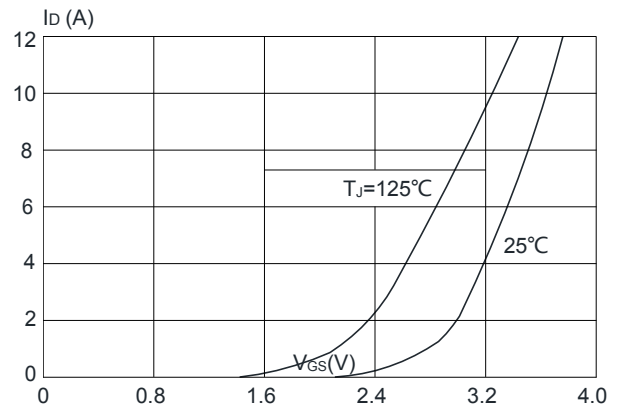

Figure 3: On-resistance vs. Drain Current

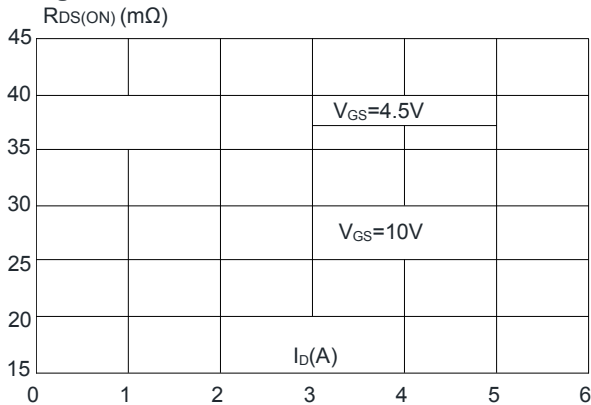

Figure 4: Body Diode Characteristics

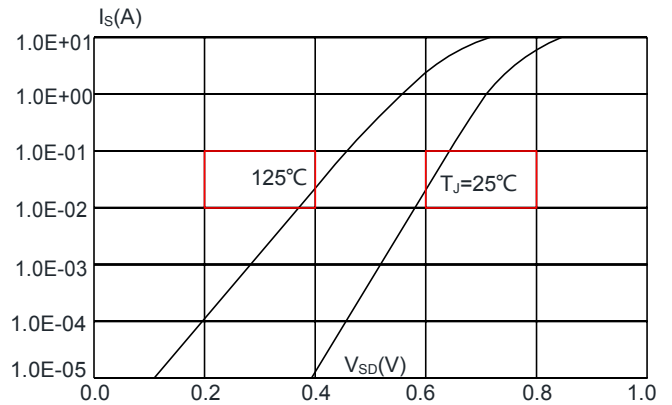

Figure 5: Gate Charge Characteristics

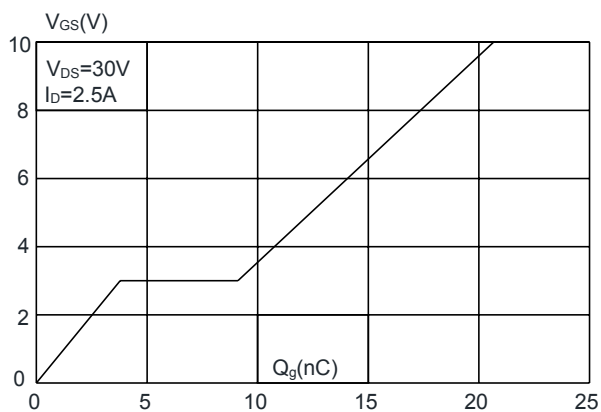
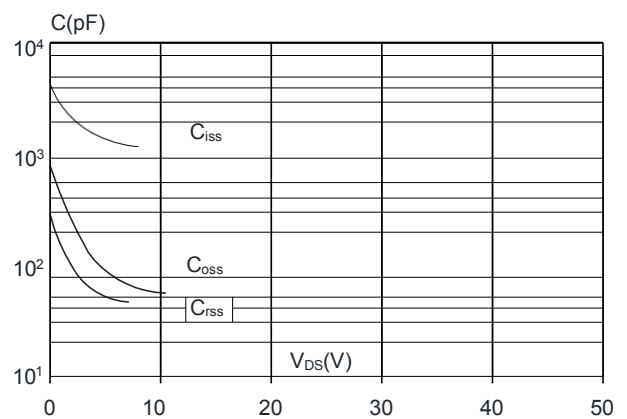

Figure 6: Capacitance Characteristics



TM06G06S

N+P-Channel Enhancement Mode Mosfet

Figure 7: Normalized Breakdown Voltage vs. Junction Temperature

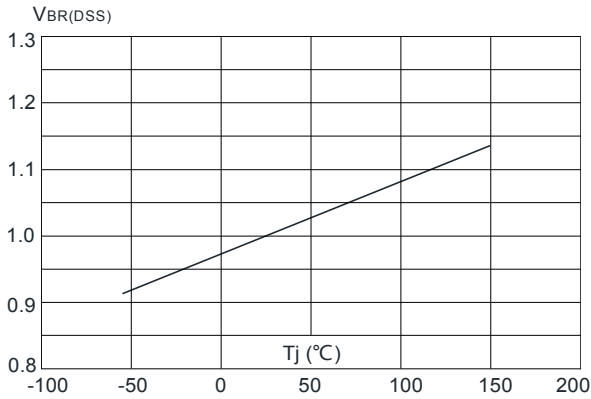

Figure 8: Normalized on Resistance vs. Junction Temperature

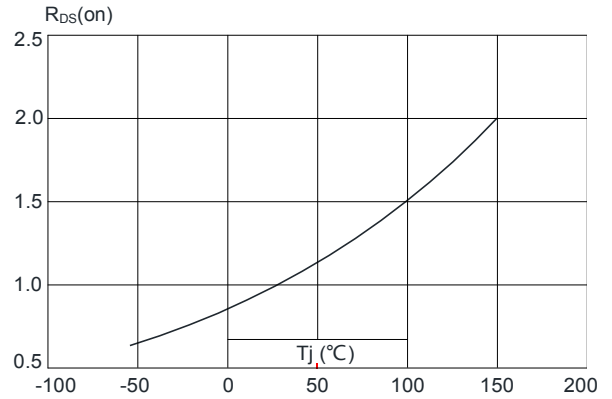

Figure 9: Maximum Safe Operating Area

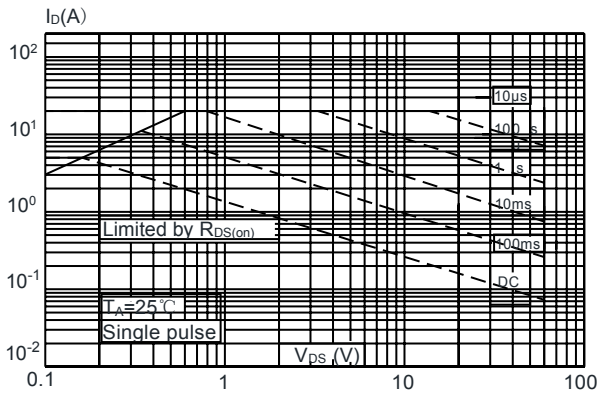

Figure 10: Maximum Continuous Drain Current vs. Ambient Temperature

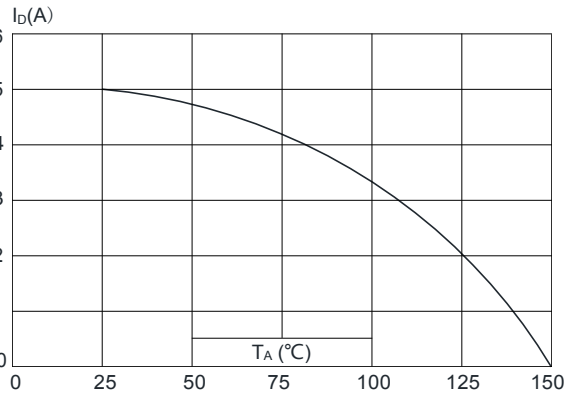
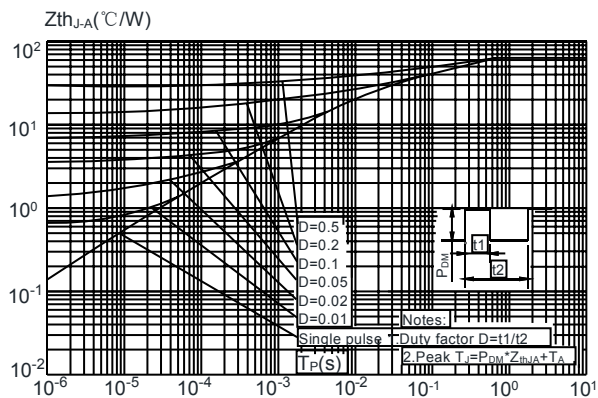

Figure.11: Maximum Effective Transient Thermal Impedance, Junction-to-Ambient



**TM06G06S**

**N+P-Channel Enhancement Mode Mosfet**

**P-Channel Typical Characteristics**

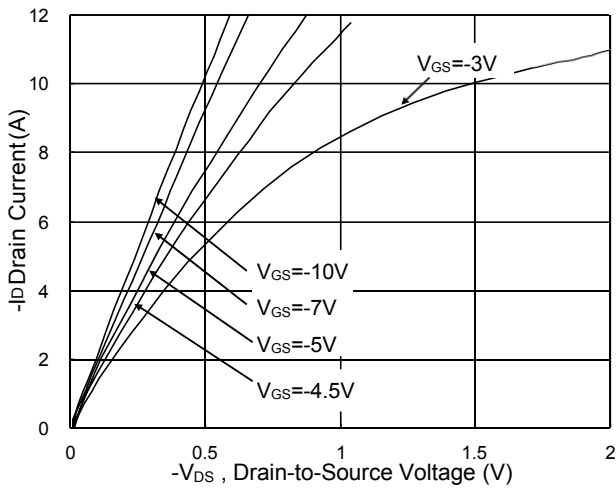

**Fig.1 Typical Output Characteristics**

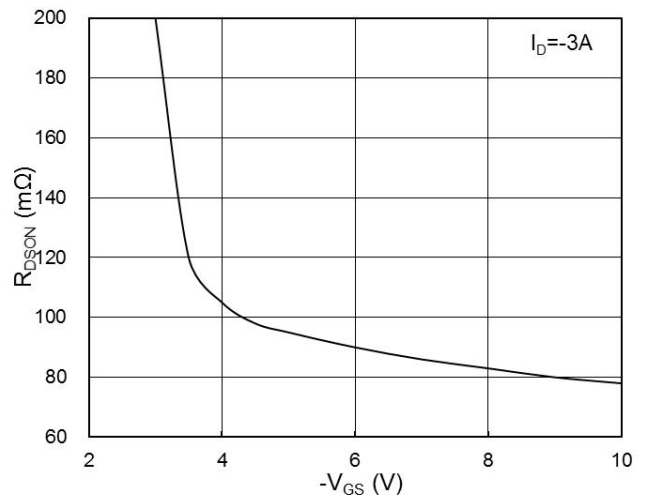

**Fig.2 On-Resistance vs. G-S Voltage**

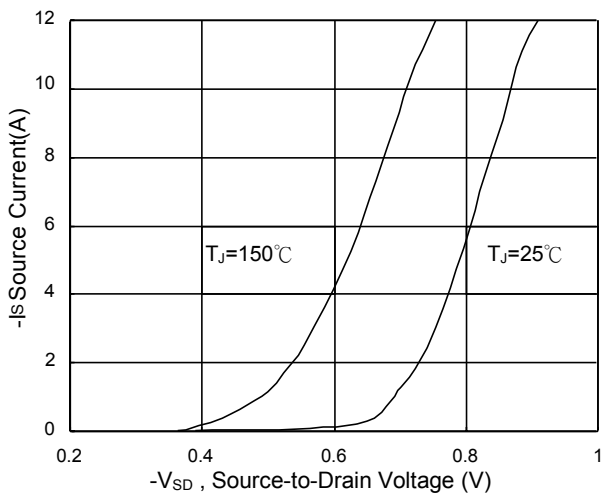

**Fig.3 Source Drain Forward Characteristics**

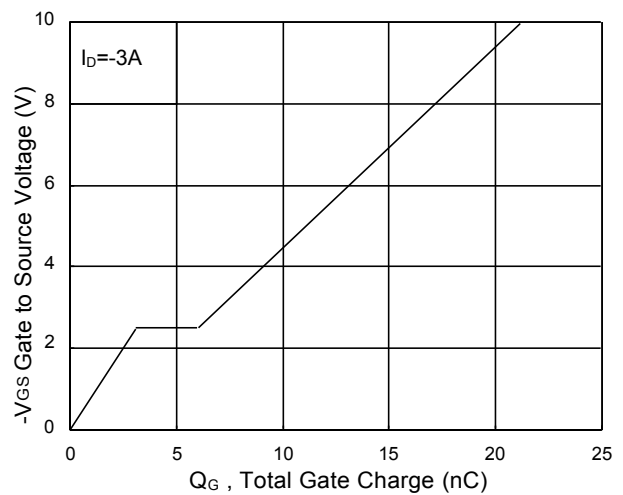

**Fig.4 Gate-Charge Characteristics**

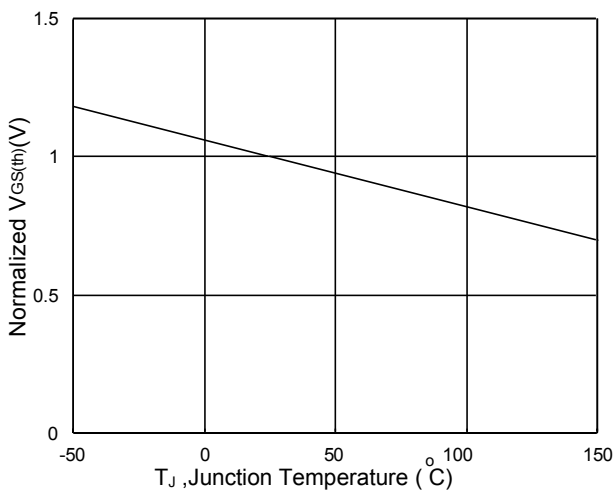

**Fig.5 Normalized  $V_{GS(th)}$  vs.  $T_J$**

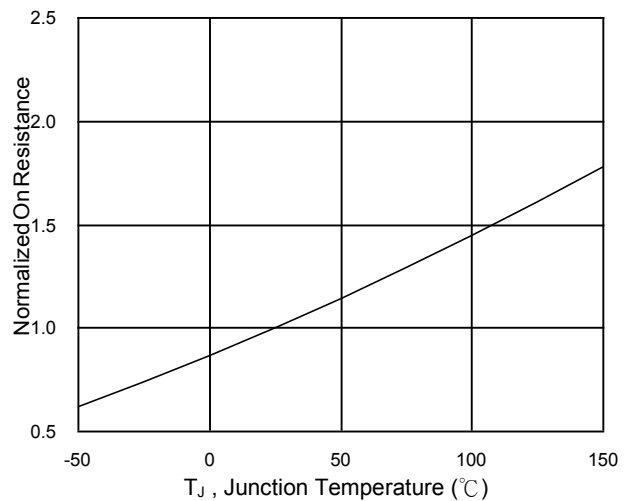

**Fig.6 Normalized  $R_{DS(on)}$  vs.  $T_J$**

TM06G06S

N+P-Channel Enhancement Mode Mosfet

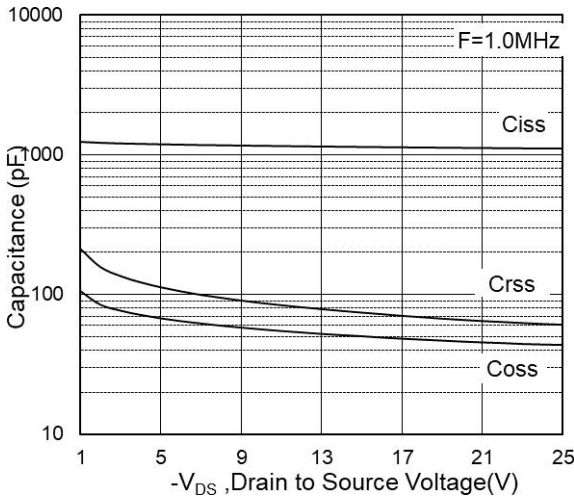

Fig.7 Capacitance

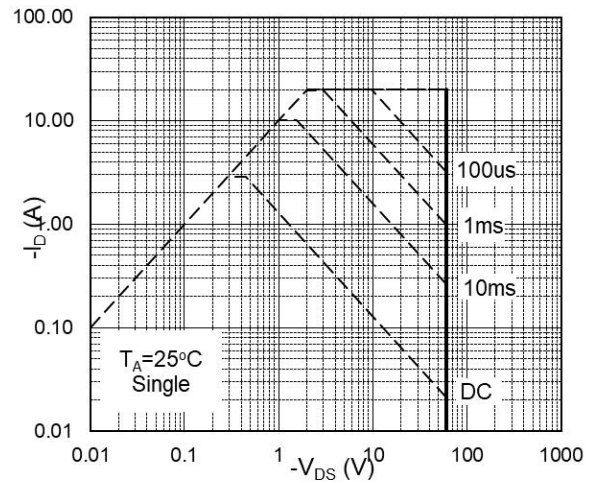

Fig.8 Safe Operating Area

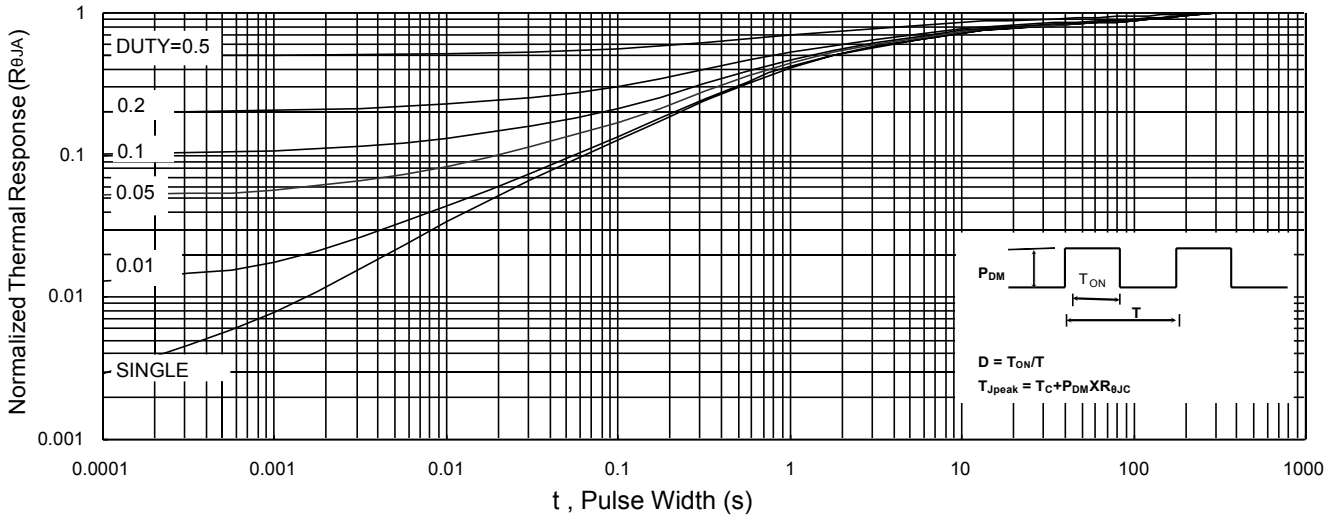

Fig.9 Normalized Maximum Transient Thermal Impedance

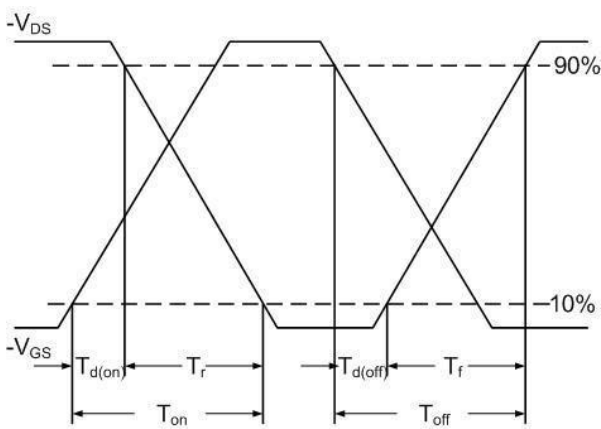

Fig.10 Switching Time Waveform

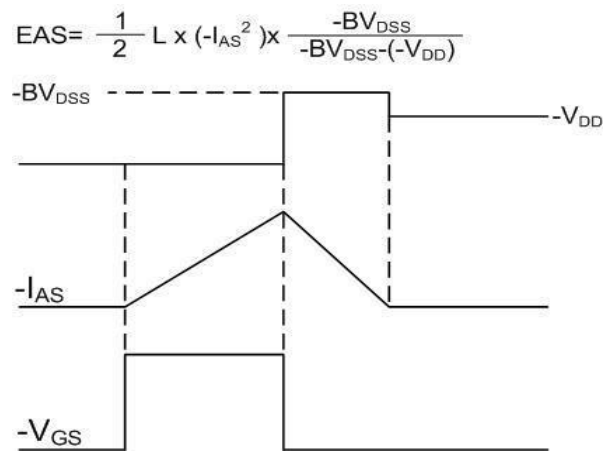
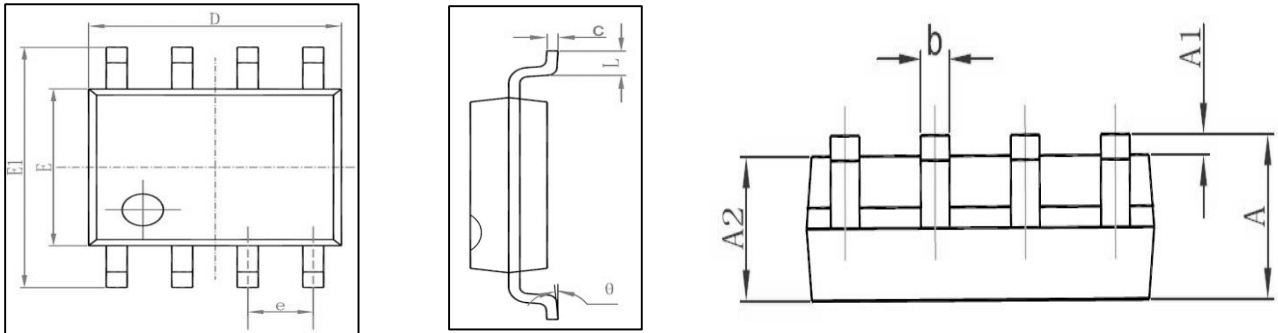

Fig.11 Unclamped Inductive Waveform

$$EAS = \frac{1}{2} L \times (-I_{AS}^2) \times \frac{-BV_{DSS}}{-BV_{DSS} - (-V_{DD})}$$

## Package Mechanical Data:SOP-8L



Symbol	Dimensions In Millimeters		Dimensions In Inches	
	Min	Max	Min	Max
A	1.350	1.750	0.053	0.069
A1	0.100	0.250	0.004	0.010
A2	1.350	1.550	0.053	0.061
b	0.330	0.510	0.013	0.020
c	0.170	0.250	0.006	0.010
D	4.700	5.100	0.185	0.200
E	3.800	4.000	0.150	0.157
E1	5.800	6.200	0.228	0.244
e	1.270 (BSC)		0.050 (BSC)	
L	0.400	1.270	0.016	0.050
θ	0°	8°	0°	8°

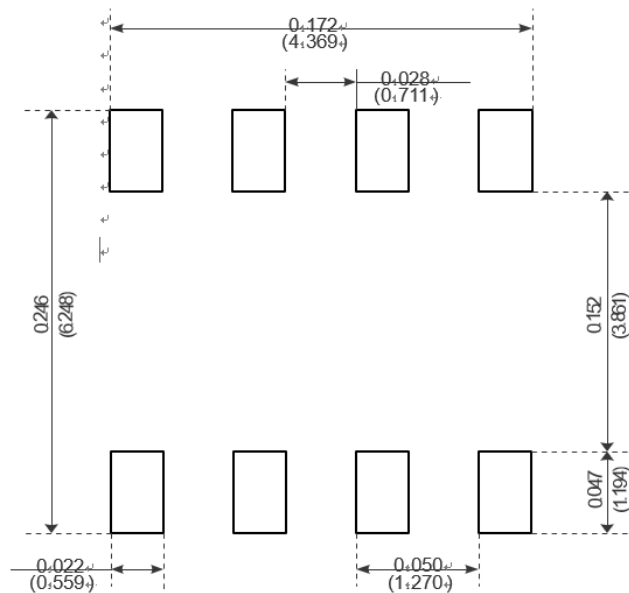

Recommended Minimum Pads



## X-ON Electronics

Largest Supplier of Electrical and Electronic Components

*Click to view similar products for [MOSFET](#) category:*

*Click to view products by [Tritech-MOS](#) manufacturer:*

Other Similar products are found below :

[IRFD120](#) [JANTX2N5237](#) [BUK455-60A/B](#) [MIC4420CM-TR](#) [VN1206L](#) [NDP4060](#) [SI4482DY](#) [IPS70R2K0CEAKMA1](#) [SQD23N06-31L-GE3](#)  
[TK16J60W,S1VQ\(O](#) [2SK2614\(TE16L1,Q\)](#) [DMN1017UCP3-7](#) [DMN1053UCP4-7](#) [SQJ469EP-T1-GE3](#) [NTE2384](#) [DMC2700UDMQ-7](#)  
[DMN2080UCB4-7](#) [DMN61D9UWQ-13](#) [US6M2GTR](#) [DMN31D5UDJ-7](#) [DMP22D4UFO-7B](#) [DMN1006UCA6-7](#) [DMN16M9UCA6-7](#)  
[STF5N65M6](#) [IRF40H233XTMA1](#) [STU5N65M6](#) [DMN6022SSD-13](#) [DMN13M9UCA6-7](#) [DMTH10H4M6SPS-13](#) [DMN2990UFB-7B](#)  
[IPB80P04P405ATMA2](#) [2N7002W-G](#) [MCAC30N06Y-TP](#) [MCQ7328-TP](#) [NTMC083NP10M5L](#) [BXP7N65D](#) [BXP4N65F](#) [AOL1454G](#)  
[WMJ80N60C4](#) [BXP2N20L](#) [BXP2N65D](#) [BXT1150N10J](#) [BXT1700P06M](#) [TSM60NB380CP](#) [ROG](#) [RQ7L055BGTGR](#) [DMNH15H110SK3-13](#)  
[SLF10N65ABV2](#) [BSO203SP](#) [BSO211P](#) [IPA60R230P6](#)