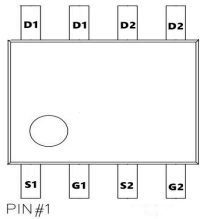
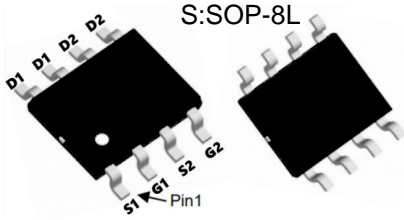
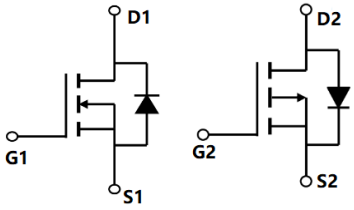

TM08G04S

N+P-Channel Enhancement Mode Mosfet

<p>General Description</p> <ul style="list-style-type: none"> • Low $R_{DS(ON)}$ • RoHS and Halogen-Free Compliant <p>Applications</p> <ul style="list-style-type: none"> • Load switch • PWM 	<p>Product Summary</p> <p>N Channel $V_{DS} = 40V, I_D = 8A$ $R_{DS(ON)} = 24m\Omega$ (typ.) @ $V_{GS} = 10V$</p> <p>P Channel $V_{DS} = -40V, I_D = -7A$ $R_{DS(ON)} = 35m\Omega$ (typ.) @ $V_{GS} = -10V$</p> <p>100% UIS Tested 100% R_g Tested</p> 
--	---

Marking: 08G04 OR 4614B

Absolute Maximum Ratings ($T_c = 25^\circ C$ unless otherwise noted)

Symbol	Parameter	Rating		Units
		N-Ch	P-Ch	
V_{DS}	Drain-Source Voltage	40	-40	V
V_{GS}	Gate-Source Voltage	± 20	± 20	V
$I_D @ T_A = 25^\circ C$	Continuous Drain Current, $V_{GS} @ 10V^1$	8	-7	A
$I_D @ T_A = 70^\circ C$	Continuous Drain Current, $V_{GS} @ 10V^1$	4.2	-4.2	A
I_{DM}	Pulsed Drain Current ²	26	-24	A
EAS	Single Pulse Avalanche Energy ³	16.2	39	mJ
$P_D @ T_A = 25^\circ C$	Total Power Dissipation ⁴	1.67	1.67	W
T_{STG}	Storage Temperature Range	-55 to 150	-55 to 150	$^\circ C$
T_J	Operating Junction Temperature Range	-55 to 150	-55 to 150	$^\circ C$
$R_{\theta JA}$	Thermal Resistance Junction-Ambient ¹	57		$^\circ C/W$
$R_{\theta JC}$	Thermal Resistance Junction-Case ¹	30		$^\circ C/W$

TM08G04S

N+P-Channel Enhancement Mode Mosfet

N-Channel Electrical Characteristics ($T_J=25^\circ\text{C}$, unless otherwise noted)

Symbol	Parameter	Conditions	Min.	Typ.	Max.	Unit
BVDSS	Drain-Source Breakdown Voltage	$V_{GS}=0V, I_D=250\mu A$	40	44	---	V
$\Delta BVDSS/\Delta T_J$	BVDSS Temperature Coefficient	Reference to 25°C , $I_D=1\text{mA}$	---	0.034	---	V/ $^\circ\text{C}$
RDS(ON)	Static Drain-Source On-Resistance ²	$V_{GS}=10V, I_D=5A$	---	24	35	m Ω
		$V_{GS}=4.5V, I_D=4A$	---	36	49	
VGS(th)	Gate Threshold Voltage	$V_{GS}=V_{DS}, I_D=250\mu A$	1.5	2.5	3.5	V
$\Delta V_{GS(th)}$	$V_{GS(th)}$ Temperature Coefficient		---	-4.56	---	mV/ $^\circ\text{C}$
IDSS	Drain-Source Leakage Current	$V_{DS}=32V, V_{GS}=0V, T_J=25^\circ\text{C}$	---	---	1	uA
		$V_{DS}=32V, V_{GS}=0V, T_J=55^\circ\text{C}$	---	---	5	
IGSS	Gate-Source Leakage Current	$V_{GS}=\pm 20V, V_{DS}=0V$	---	---	± 100	nA
gfs	Forward Transconductance	$V_{DS}=5V, I_D=5A$	---	14	---	S
Rg	Gate Resistance	$V_{DS}=0V, V_{GS}=0V, f=1\text{MHz}$	---	2.6	---	Ω
Qg	Total Gate Charge (4.5V)	$V_{DS}=20V, V_{GS}=4.5V, I_D=5A$	---	5.5	---	nC
Qgs	Gate-Source Charge		---	1.25	---	
Qgd	Gate-Drain Charge		---	2.5	---	
Td(on)	Turn-On Delay Time	$V_{DD}=20V, V_{GS}=10V, R_G=3.3\Omega, I_D=1A$	---	8.9	---	ns
Tr	Rise Time		---	2.2	---	
Td(off)	Turn-Off Delay Time		---	41	---	
Tf	Fall Time		---	2.7	---	
Ciss	Input Capacitance	$V_{DS}=15V, V_{GS}=0V, f=1\text{MHz}$	---	593	---	pF
Coss	Output Capacitance		---	76	---	
Crss	Reverse Transfer Capacitance		---	56	---	
Is	Continuous Source Current ^{1,5}	$V_G=V_D=0V, \text{Force Current}$	---	---	6.1	A
ISM	Pulsed Source Current ^{2,5}		---	---	23	A
VSD	Diode Forward Voltage ²	$V_{GS}=0V, I_S=1A, T_J=25^\circ\text{C}$	---	---	1.2	V

Note :

- 1、The data tested by surface mounted on a 1 inch² FR-4 board with 2OZ copper.
- 2、The data tested by pulsed , pulse width $\cong 300\mu s$, duty cycle $\cong 2\%$
- 3、The EAS data shows Max. rating . The test condition is $V_{DD}=25V, V_{GS}=10V, L=0.1\text{mH}, I_{AS}=10A$
- 4、The power dissipation is limited by 150°C junction temperature
- 5、The data is theoretically the same as I_D and I_{DM} , in real applications , should be limited by total power dissipation.

TM08G04S

N+P-Channel Enhancement Mode Mosfet

P-Channel Electrical Characteristics (T_J=25 °C, unless otherwise noted)

Symbol	Parameter	Conditions	Min.	Typ.	Max.	Unit
BVDSS	Drain-Source Breakdown Voltage	V _{GS} =0V, I _D =-250uA	-40	---	---	V
ΔBVDSS/ΔT _J	BV _{DSS} Temperature Coefficient	Reference to 25°C, I _D =-1mA	---	-0.02	---	V/°C
RDS(ON)	Static Drain-Source On-Resistance ²	V _{GS} =-10V, I _D =-5A	---	35	48	mΩ
		V _{GS} =-4.5V, I _D =-3A	---	49	68	
VGS(th)	Gate Threshold Voltage	V _{GS} =V _{DS} , I _D =-250uA	-1.5	-2.5	-3.5	V
ΔVGS(th)	V _{GS(th)} Temperature Coefficient		---	3.72	---	mV/°C
IDSS	Drain-Source Leakage Current	V _{DS} =-32V, V _{GS} =0V, T _J =25°C	---	---	1	uA
		V _{DS} =-32V, V _{GS} =0V, T _J =55°C	---	---	5	
IGSS	Gate-Source Leakage Current	V _{GS} =±20V, V _{DS} =0V	---	---	±100	nA
Q _g	Total Gate Charge (-4.5V)	V _{DS} =-20V, V _{GS} =-4.5V, I _D =-6A	---	15.8	---	nC
Q _{gs}	Gate-Source Charge		---	3.5	---	
Q _{gd}	Gate-Drain Charge		---	3.2	---	
Td(on)	Turn-On Delay Time	V _{DD} =-15V, V _{GS} =-10V, R _G =3.3Ω, I _D =-1A	---	5.2	---	ns
T _r	Rise Time		---	7	---	
Td(off)	Turn-Off Delay Time		---	23	---	
T _f	Fall Time		---	8	---	
C _{iss}	Input Capacitance	V _{DS} =-15V, V _{GS} =0V, f=1MHz	---	1000	---	pF
C _{oss}	Output Capacitance		---	160	---	
C _{rss}	Reverse Transfer Capacitance		---	100	---	
I _s	Continuous Source Current ^{1,5}	V _G =V _D =0V, Force Current	---	---	-5.7	A
VSD	Diode Forward Voltage ²	V _{GS} =0V, I _s =-1A, T _J =25°C	---	---	-1.2	V

Note :

- 1、 The data tested by surface mounted on a 1 inch² FR-4 board with 20Z copper.
- 2、 The data tested by pulsed, pulse width ≦ 300us, duty cycle ≦ 2%
- 3、 The EAS data shows Max. rating. The test condition is V^{DD}=-25V, V^{GS}=-10V, L=0.1mH, I^{AS}=-7A
- 4、 The power dissipation is limited by 150°C junction temperature
- 5、 The data is theoretically the same as I_D and I_{DM}, in real applications, should be limited by total power dissipation.



TM08G04S

N+P-Channel Enhancement Mode Mosfet

N-Channel Typical Characteristics

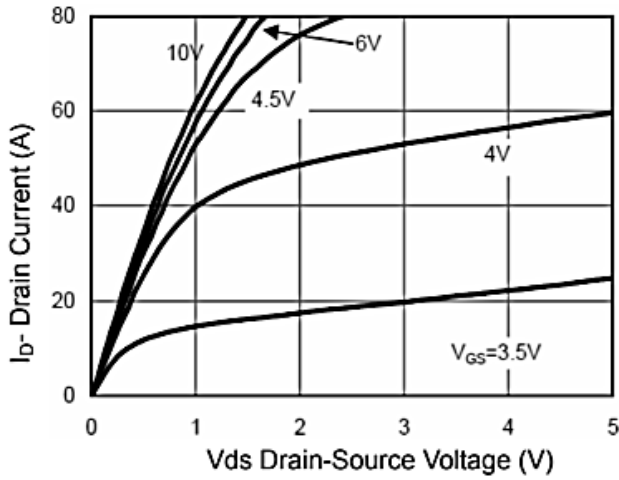

Figure 1 Output Characteristics

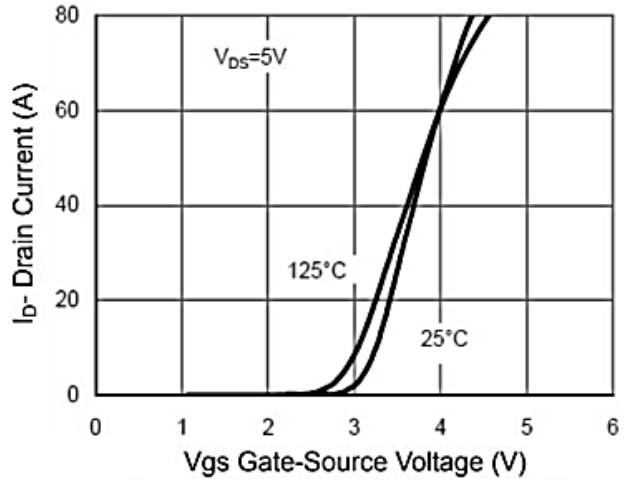

Figure 2 Transfer Characteristics

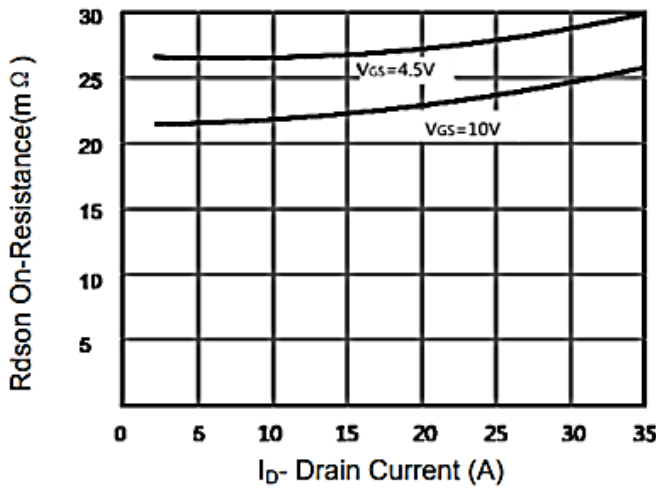

Figure 3 Rdson- Drain Current

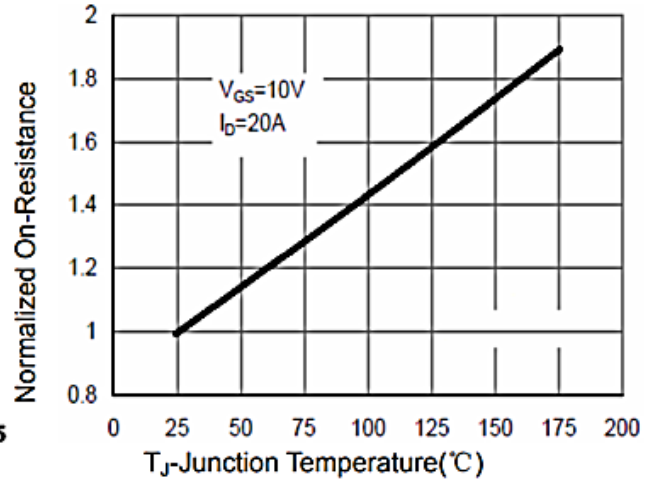

Figure 4 Rdson-Junction Temperature

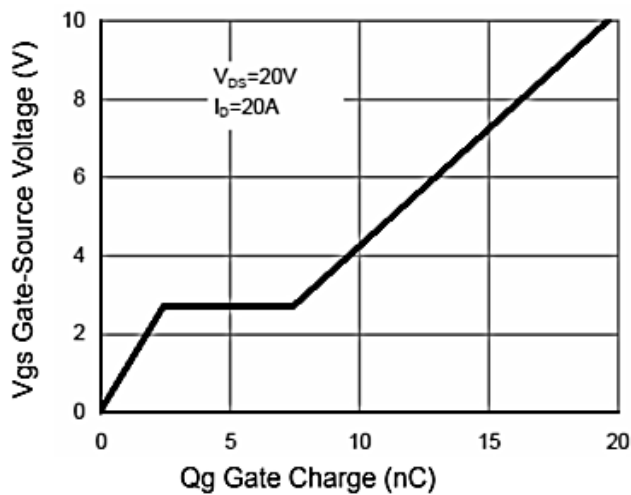

Figure 5 Gate Charge

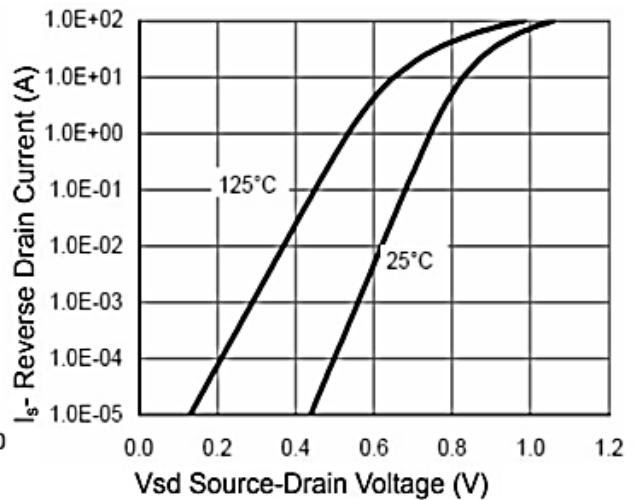

Figure 6 Source- Drain Diode Forward



TM08G04S

N+P-Channel Enhancement Mode Mosfet

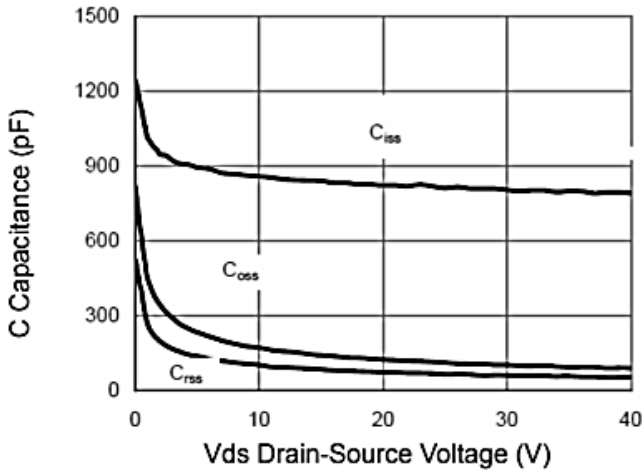

Figure 7 Capacitance vs Vds

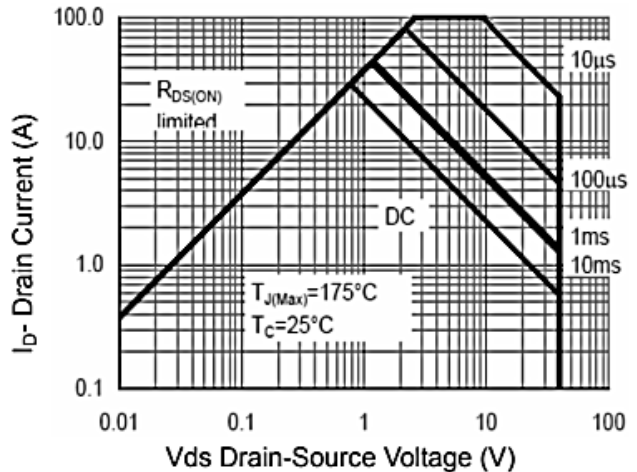

Figure 8 Safe Operation Area

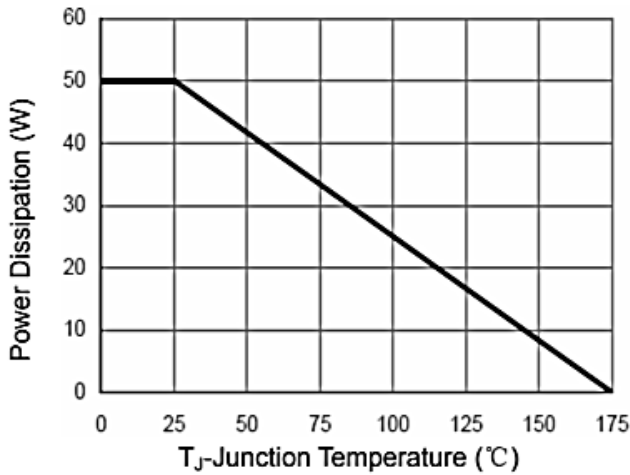

Figure 9 Power De-rating

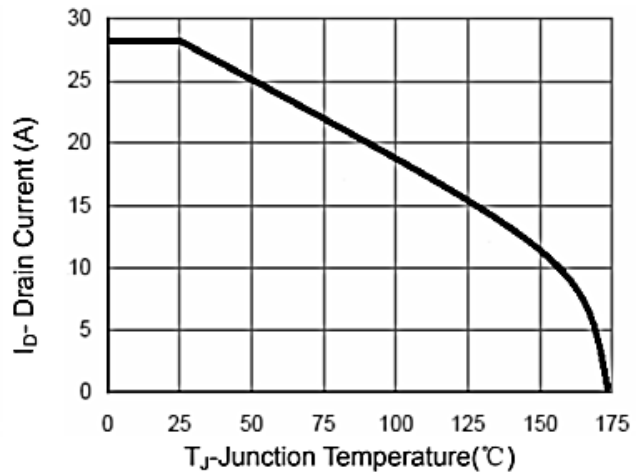

Figure 10 Id Current De-rating

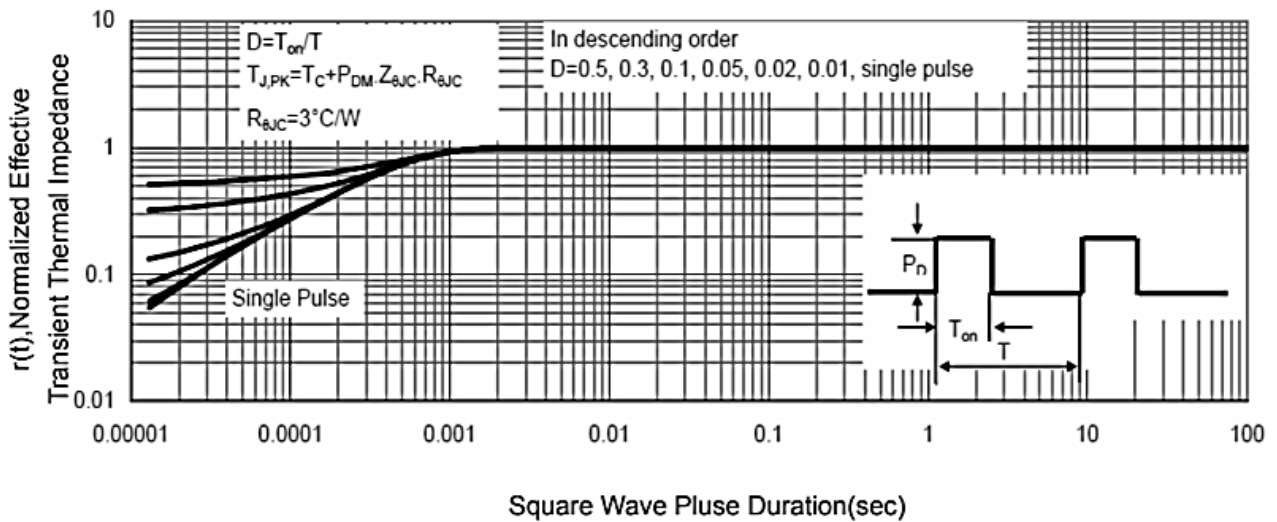

Figure 11 Normalized Maximum Transient Thermal Impedance



TM08G04S

N+P-Channel Enhancement Mode Mosfet

P-Channel Typical Characteristics

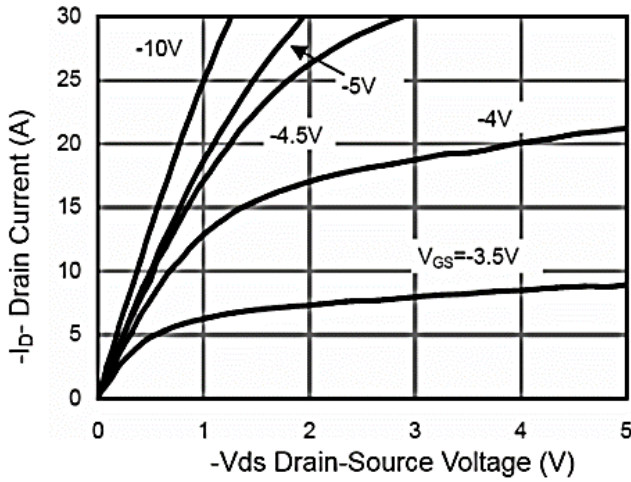

Figure 1 Output Characteristics

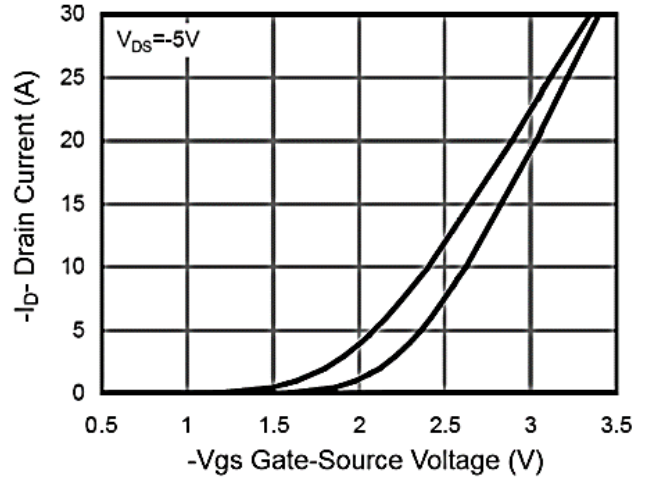

Figure 2 Transfer Characteristics

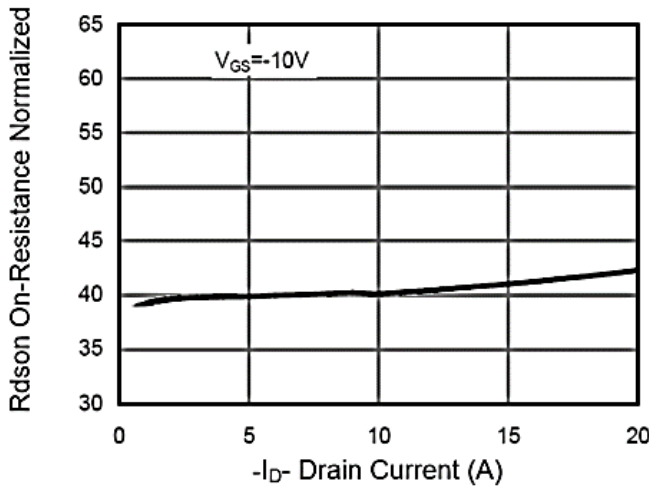

Figure 3 Rdson- Drain Current

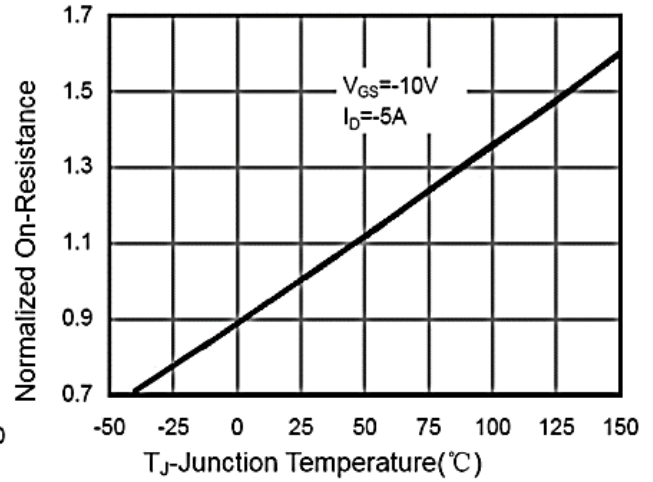

Figure 4 Rdson-Junction Temperature

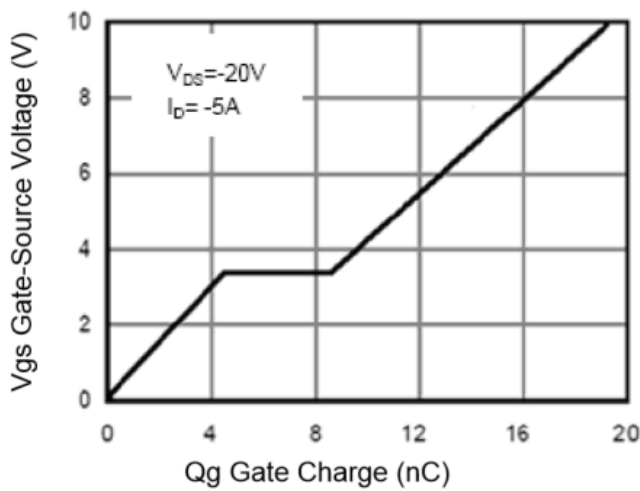

Figure 5 Gate Charge

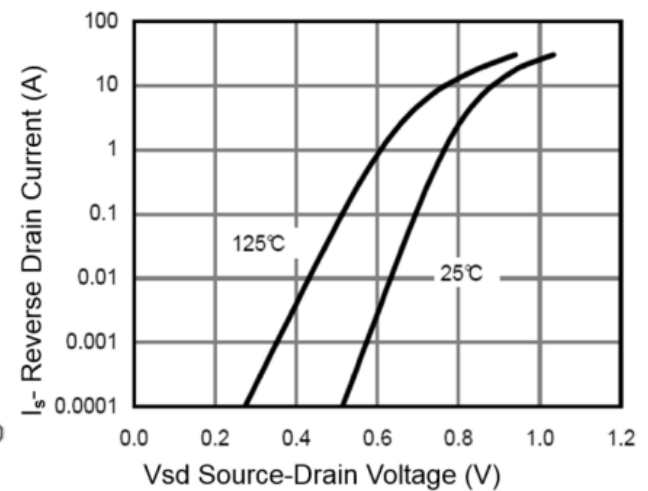

Figure 6 Source- Drain Diode Forward

TM08G04S

N+P-Channel Enhancement Mode Mosfet

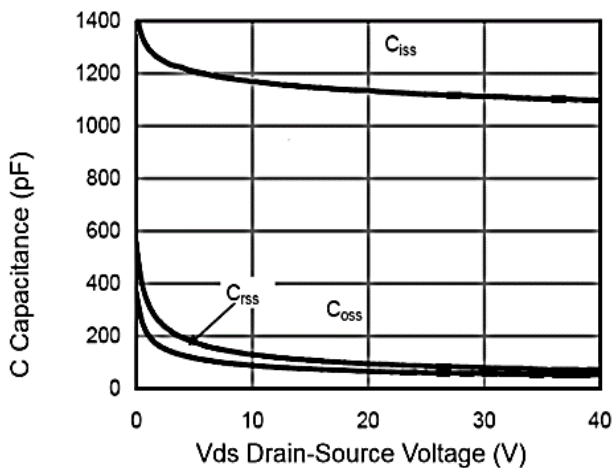

Figure 7 Capacitance vs Vds

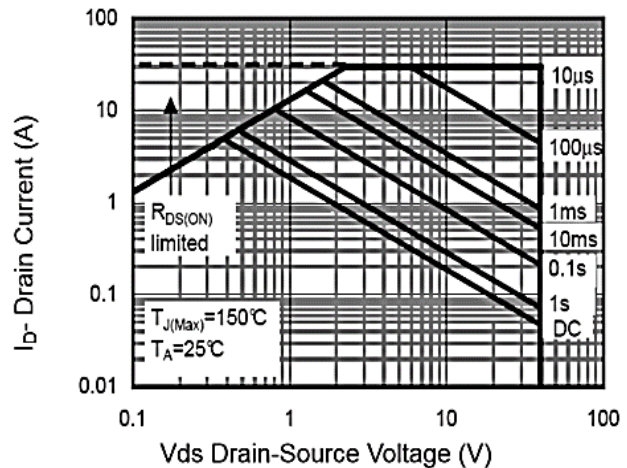

Figure 8 Safe Operation Area

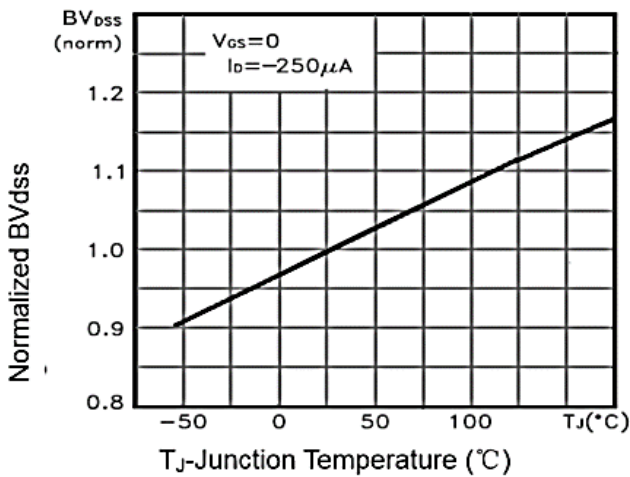

Figure 9 BV_{DSS} vs Junction Temperature

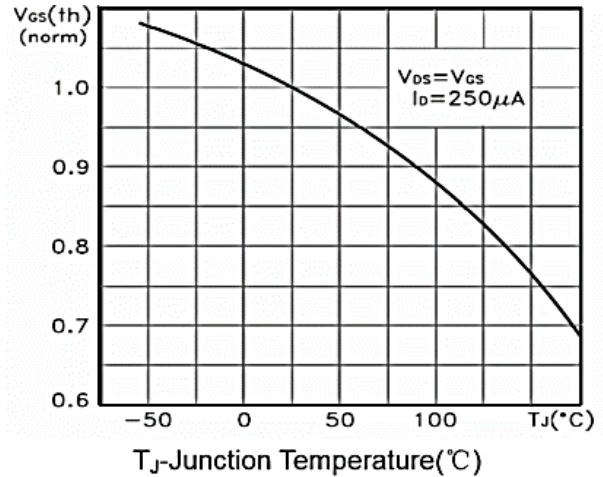

Figure 10 $V_{GS(th)}$ vs Junction Temperature

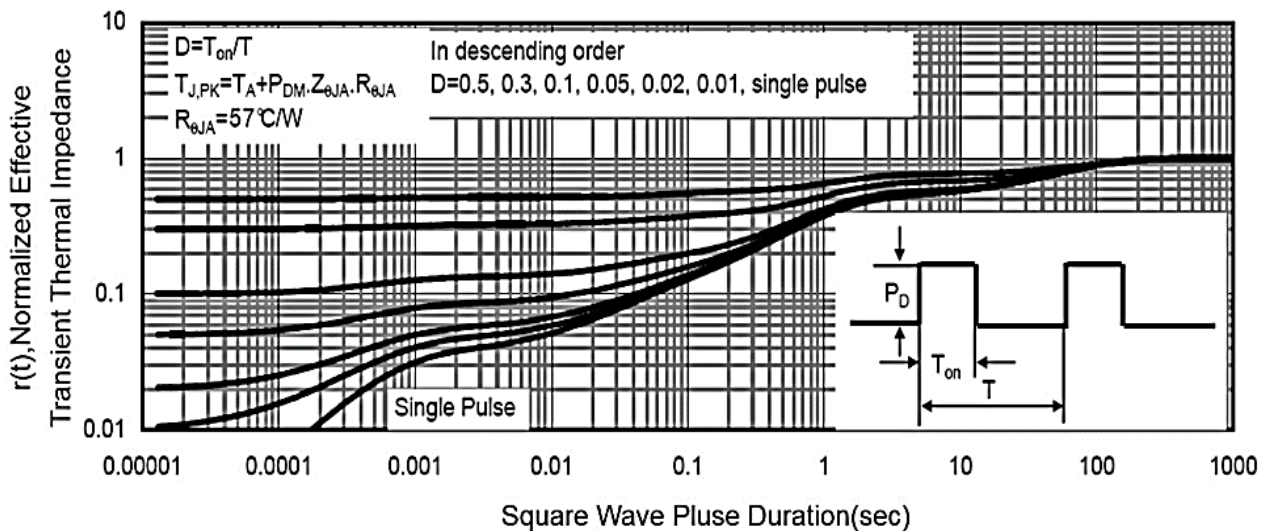
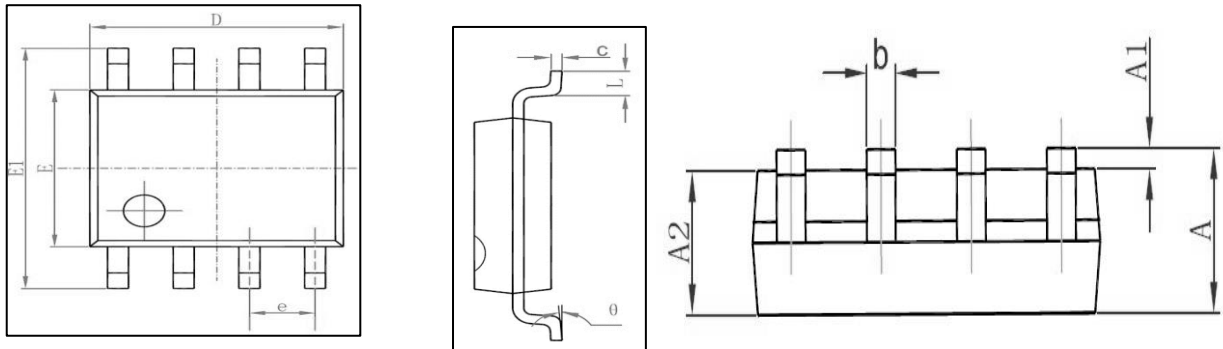
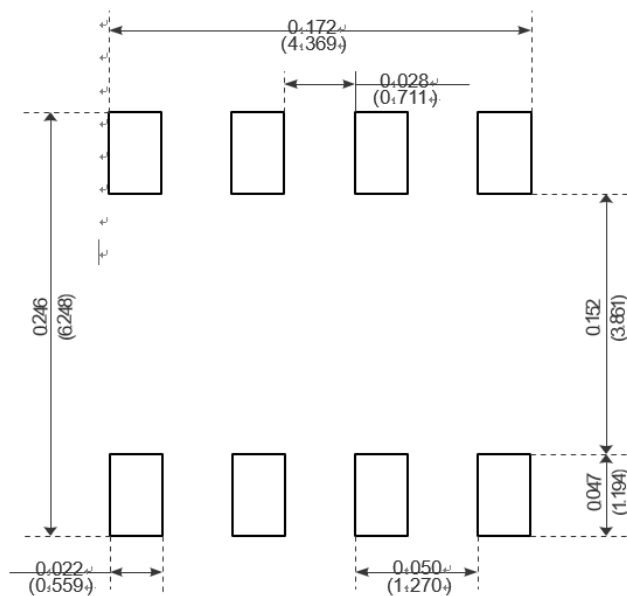

Figure 11 Normalized Maximum Transient Thermal Impedance

Package Mechanical Data:SOP-8L



Symbol	Dimensions In Millimeters		Dimensions In Inches	
	Min	Max	Min	Max
A	1.350	1.750	0.053	0.069
A1	0.100	0.250	0.004	0.010
A2	1.350	1.550	0.053	0.061
b	0.330	0.510	0.013	0.020
c	0.170	0.250	0.006	0.010
D	4.700	5.100	0.185	0.200
E	3.800	4.000	0.150	0.157
E1	5.800	6.200	0.228	0.244
e	1.270 (BSC)		0.050 (BSC)	
L	0.400	1.270	0.016	0.050
θ	0°	8°	0°	8°



Recommended Minimum Pads

X-ON Electronics

Largest Supplier of Electrical and Electronic Components

Click to view similar products for [MOSFET](#) category:

Click to view products by [Tritech-MOS](#) manufacturer:

Other Similar products are found below :

[IRFD120](#) [JANTX2N5237](#) [BUK455-60A/B](#) [MIC4420CM-TR](#) [VN1206L](#) [NDP4060](#) [SI4482DY](#) [IPS70R2K0CEAKMA1](#) [SQD23N06-31L-GE3](#)
[TK16J60W,S1VQ\(O](#) [2SK2614\(TE16L1,Q\)](#) [DMN1017UCP3-7](#) [DMN1053UCP4-7](#) [SQJ469EP-T1-GE3](#) [NTE2384](#) [DMC2700UDMQ-7](#)
[DMN2080UCB4-7](#) [DMN61D9UWQ-13](#) [US6M2GTR](#) [DMN31D5UDJ-7](#) [DMP22D4UFO-7B](#) [DMN1006UCA6-7](#) [DMN16M9UCA6-7](#)
[STF5N65M6](#) [IRF40H233XTMA1](#) [STU5N65M6](#) [DMN6022SSD-13](#) [DMN13M9UCA6-7](#) [DMTH10H4M6SPS-13](#) [DMN2990UFB-7B](#)
[IPB80P04P405ATMA2](#) [2N7002W-G](#) [MCAC30N06Y-TP](#) [MCQ7328-TP](#) [BXP7N65D](#) [BXP4N65F](#) [AOL1454G](#) [WMJ80N60C4](#) [BXP2N20L](#)
[BXP2N65D](#) [BXT1150N10J](#) [BXT1700P06M](#) [TSM60NB380CP](#) [ROG](#) [RQ7L055BGTCR](#) [DMNH15H110SK3-13](#) [SLF10N65ABV2](#)
[BSO203SP](#) [BSO211P](#) [IPA60R230P6](#) [IPA60R460CE](#)