

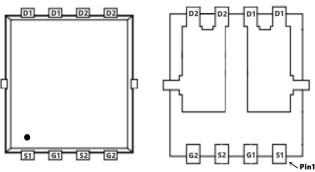

TM25H03DF

N+N-Channel Enhancement Mosfet

<p>General Description</p> <ul style="list-style-type: none"> • Low R_{DS(ON)} • RoHS and Halogen-Free Compliant <p>Applications</p> <ul style="list-style-type: none"> • Load switch • PWM 	<p>Product Summary</p> <p>V_{DS} = 30V I_D =25A</p> <p>R_{DS(ON)} = 14 mΩ (Typ.) @ V_{GS}=10V</p> <p>100% UIS Tested</p> <p>100% R_g Tested</p>	
---	--	---



Marking:304

DF:DFN3x3_8L

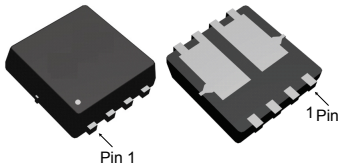

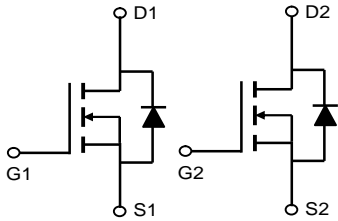

Absolute Maximum Ratings (T_A=25°C Unless Otherwise Noted)

Symbol	Parameter	Rating	Units
V _{DS}	Drain-Source Voltage	30	V
V _{GS}	Gate-Source Voltage	±20	V
I _D @T _C =25°C	Continuous Drain Current, V _{GS} @ 10V ¹	25	A
I _D @T _C =100°C	Continuous Drain Current, V _{GS} @ 10V ¹	14	A
I _{DM}	Pulsed Drain Current ²	76	A
EAS	Single Pulse Avalanche Energy ³	12.1	mJ
I _{AS}	Avalanche Current	48	A
P _D @T _C =25°C	Total Power Dissipation ⁴	6.0	W
T _{STG}	Storage Temperature Range	-55 to 150	°C
T _J	Operating Junction Temperature Range	-55 to 150	°C

Thermal Data

Symbol	Parameter	Typ.	Max.	Unit
R _{θJA}	Thermal Resistance Junction-ambient ¹	---	75	°C/W



TM25H03DF

N+N-Channel Enhancement Mosfet

Electrical Characteristics ($T_J=25^{\circ}\text{C}$ unless otherwise specified)

Symbol	Parameter	Test Condition	Min.	Typ.	Max.	Units
Off Characteristic						
$V_{(BR)DSS}$	Drain-Source Breakdown Voltage	$V_{GS}=0V, I_D=250\mu A$	30	-	-	V
I_{DSS}	Zero Gate Voltage Drain Current	$V_{DS}=30V, V_{GS}=0V$	-	-	1	μA
I_{GSS}	Gate to Body Leakage Current	$V_{DS}=0V, V_{GS}=\pm 20V$	-	-	± 100	nA
On Characteristics						
$V_{GS(th)}$	Gate Threshold Voltage	$V_{DS}=V_{GS}, I_D=250\mu A$	1.0	1.5	2.5	V
$R_{DS(on)}$	Static Drain-Source on-Resistance <small>note2</small>	$V_{GS}=10V, I_D=5A$	-	14	17	m Ω
		$V_{GS}=4.5V, I_D=3A$	-	18	26	m Ω
Dynamic Characteristics						
C_{iss}	Input Capacitance	$V_{DS}=15V, V_{GS}=0V,$ $f=1.0MHz$	-	520	-	pF
C_{oss}	Output Capacitance		-	79	-	pF
C_{rss}	Reverse Transfer Capacitance		-	61	-	pF
Q_g	Total Gate Charge	$V_{DS}=15V, I_D=5.8A,$ $V_{GS}=10V$	-	5.2	-	nC
Q_{gs}	Gate-Source Charge		-	0.9	-	nC
Q_{gd}	Gate-Drain("Miller") Charge		-	1.3	-	nC
Switching Characteristics						
$t_{d(on)}$	Turn-on Delay Time	$V_{DS}=15V, I_D=3A,$ $V_{GS}=10V, R_{REN}=3\Omega$	-	4.5	-	ns
t_r	Turn-on Rise Time		-	2.5	-	ns
$t_{d(off)}$	Turn-off Delay Time		-	14.5	-	ns
t_f	Turn-off Fall Time		-	3.5	-	ns
Drain-Source Diode Characteristics and Maximum Ratings						
I_S	Maximum Continuous Drain to Source Diode Forward Current	-	-	12	-	A
I_{SM}	Maximum Pulsed Drain to Source Diode Forward Current	-	-	48	-	A
V_{SD}	Drain to Source Diode Forward Voltage	$V_{GS}=0V, I_S=12A$	-	-	1.2	V

Diode Characteristics

Symbol	Parameter	Conditions	Min.	Typ.	Max.	Unit
I_S	Continuous Source Current ^{1,5}	$V_G=V_D=0V$, Force Current	---	---	25	A
I_{SM}	Pulsed Source Current ^{2,5}		---	---	56	A
V_{SD}	Diode Forward Voltage ²	$V_{GS}=0V, I_S=1A, T_J=25^{\circ}\text{C}$	---	---	1.2	V

Note :

- The data tested by surface mounted on a 1 inch² FR-4 board with 2OZ copper.
- The data tested by pulsed, pulse width $\leq 300\mu s$, duty cycle $\leq 2\%$
- The EAS data shows Max. rating. The test condition is $V_{DD}=25V, V_{GS}=10V, L=0.1mH, I_{AS}=21A$
- The power dissipation is limited by 150 $^{\circ}\text{C}$ junction temperature
- The data is theoretically the same as I_D and I_{DM} , in real applications, should be limited by total power dissipation.

Typical Performance Characteristics

Figure 1: Output Characteristics

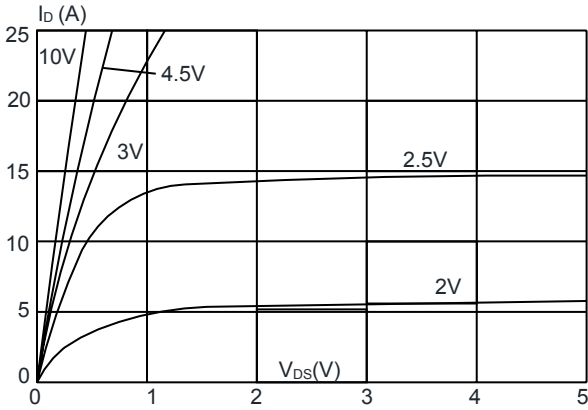

Figure 2: Typical Transfer Characteristics

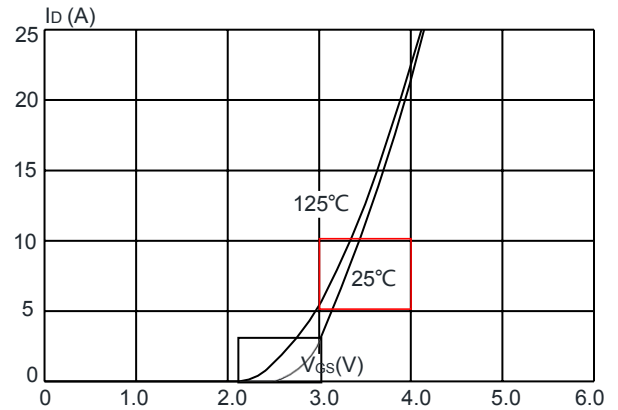

Figure 3: On-resistance vs. Drain Current

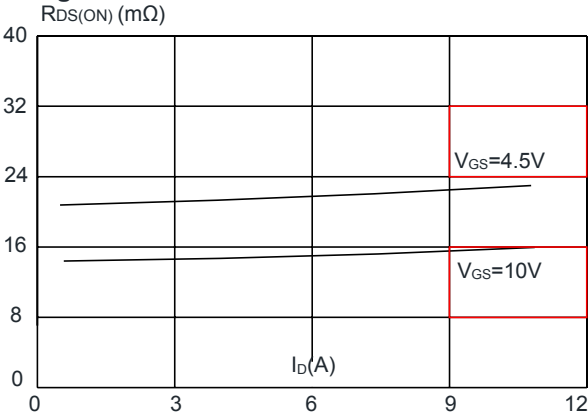

Figure 4: Body Diode Characteristics

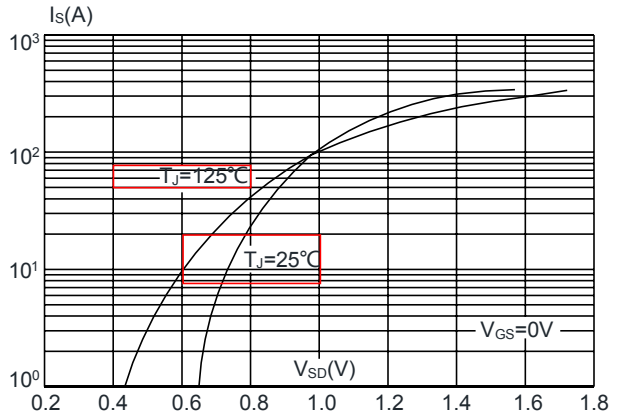

Figure 5: Gate Charge Characteristics

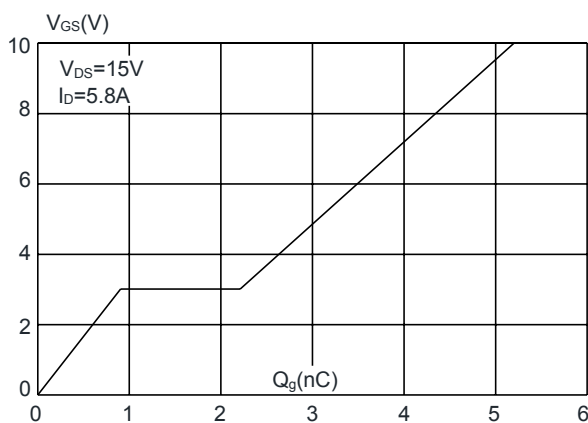
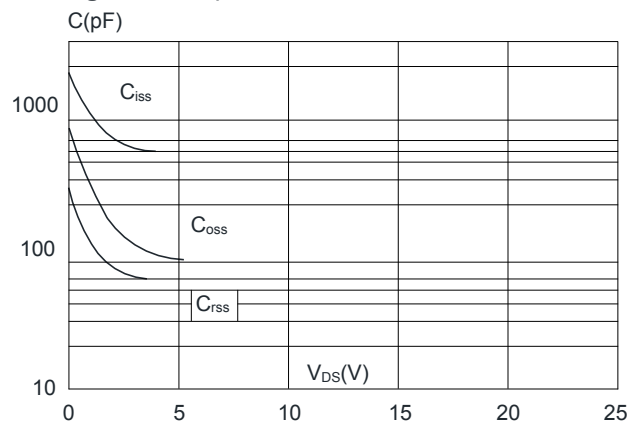

Figure 6: Capacitance Characteristics



TM25H03DF

N+N-Channel Enhancement Mosfet

Figure 7: Normalized Breakdown Voltage vs. Junction Temperature

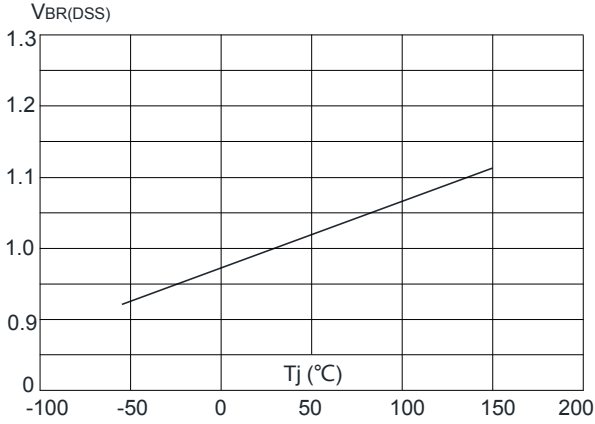

Figure 8: Normalized on Resistance vs. Junction Temperature

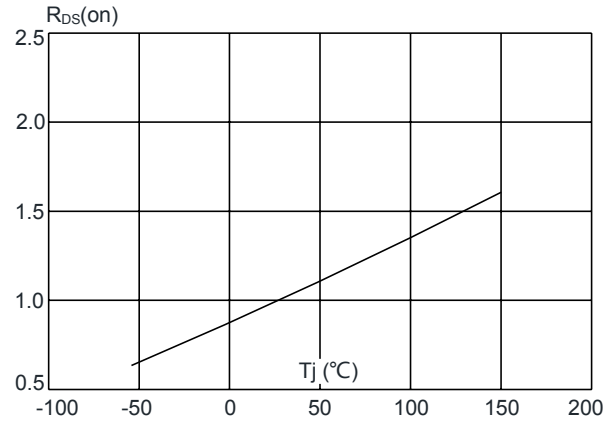

Figure 9: Maximum Safe Operating Area

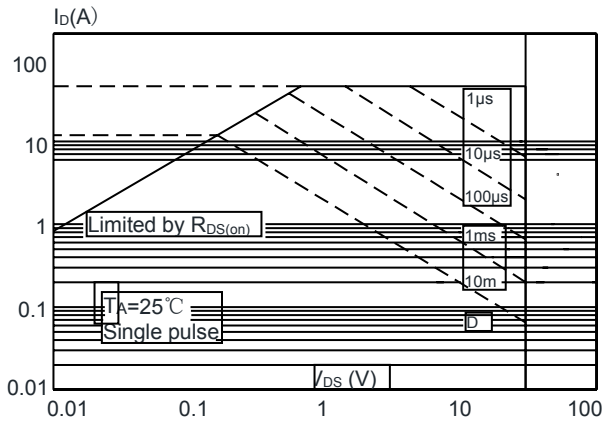

Figure 10: Maximum Continuous Drain Current vs. Ambient Temperature

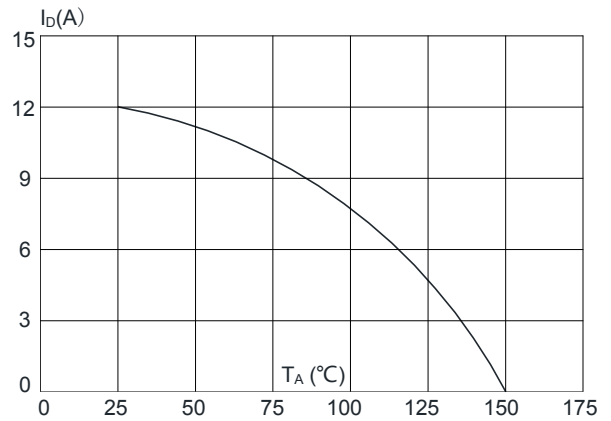
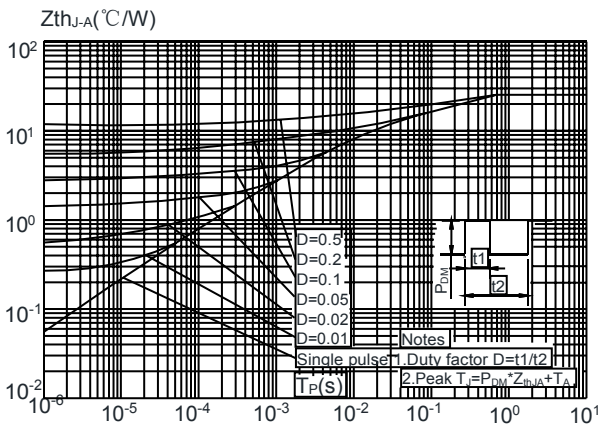
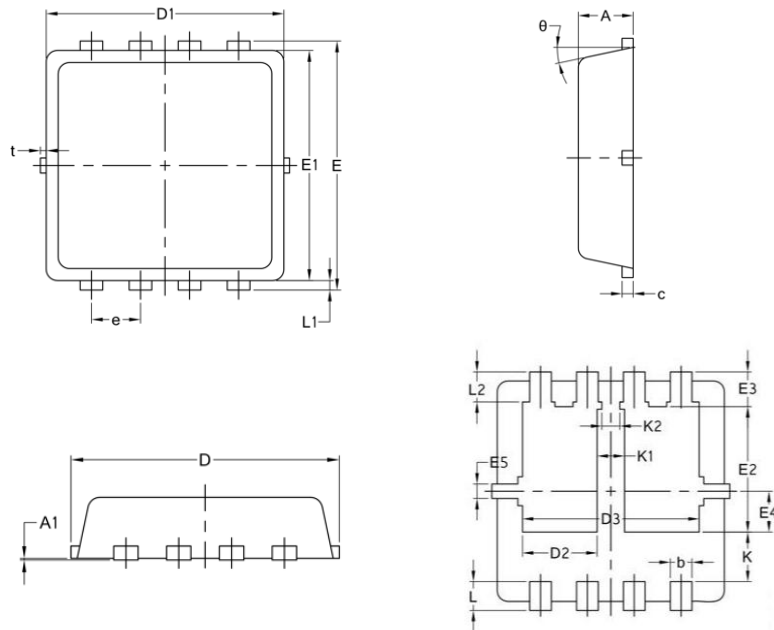

Figure.11: Maximum Effective Transient Thermal Impedance, Junction-to-Ambient



Package Mechanical Data:DFN3x3-8L



Symbol	Common		
	Mm		
	Min	Nom	Max
A	0.70	0.75	0.85
A1	/	/	0.05
b	0.25	0.30	0.39
c	0.14	0.152	0.20
D	3.20	3.30	3.45
D1	3.05	3.15	3.25
D2	0.84	1.04	1.24
D3	2.30	2.45	2.60
E	3.20	3.30	3.40
E1	2.95	3.05	3.15
E2	1.60	1.74	1.90
E3	0.28	0.48	0.65
E4	0.37	0.57	0.77
E5	0.10	0.20	0.30
e	0.60	0.65	0.70
K	0.50	0.69	0.80
K1	0.30	0.38	0.53
K2	0.15	0.25	0.35
L	0.30	0.40	0.50
L1	0.06	0.125	0.20
L2	0.27	0.42	0.57
t	0	0.075	0.13
Φ	10°	12°	14°

X-ON Electronics

Largest Supplier of Electrical and Electronic Components

Click to view similar products for [MOSFET](#) category:

Click to view products by [Tritech-MOS](#) manufacturer:

Other Similar products are found below :

[IRFD120](#) [JANTX2N5237](#) [BUK455-60A/B](#) [MIC4420CM-TR](#) [VN1206L](#) [NDP4060](#) [SI4482DY](#) [IPS70R2K0CEAKMA1](#) [SQD23N06-31L-GE3](#)
[TK16J60W,S1VQ\(O](#) [2SK2614\(TE16L1,Q\)](#) [DMN1017UCP3-7](#) [DMN1053UCP4-7](#) [SQJ469EP-T1-GE3](#) [NTE2384](#) [DMC2700UDMQ-7](#)
[DMN2080UCB4-7](#) [DMN61D9UWQ-13](#) [US6M2GTR](#) [DMN31D5UDJ-7](#) [DMP22D4UFO-7B](#) [DMN1006UCA6-7](#) [DMN16M9UCA6-7](#)
[STF5N65M6](#) [IRF40H233XTMA1](#) [STU5N65M6](#) [DMN6022SSD-13](#) [DMN13M9UCA6-7](#) [DMTH10H4M6SPS-13](#) [DMN2990UFB-7B](#)
[IPB80P04P405ATMA2](#) [2N7002W-G](#) [MCAC30N06Y-TP](#) [MCQ7328-TP](#) [NTMC083NP10M5L](#) [NVMFS2D3P04M8LT1G](#) [BXP7N65D](#)
[BXP4N65F](#) [AOL1454G](#) [WMJ80N60C4](#) [BXP2N20L](#) [BXP2N65D](#) [BXT1150N10J](#) [BXT1700P06M](#) [TSM60NB380CP](#) [ROG](#) [RQ7L055BGTCR](#)
[DMNH15H110SK3-13](#) [SLF10N65ABV2](#) [BSO203SP](#) [BSO211P](#)